

## IDENTIFICATION OF PARTS

Front

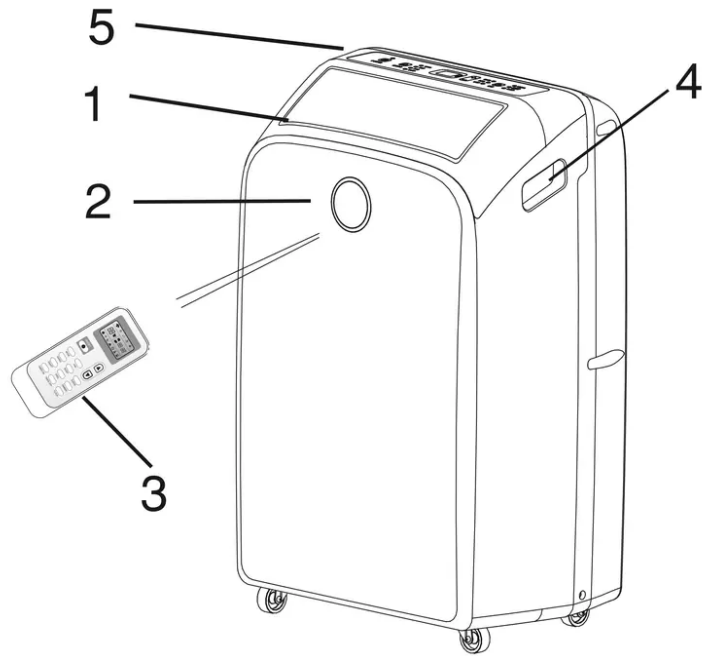

## Back

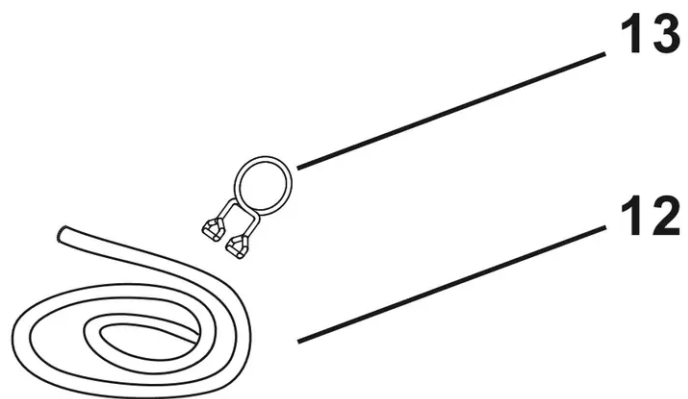
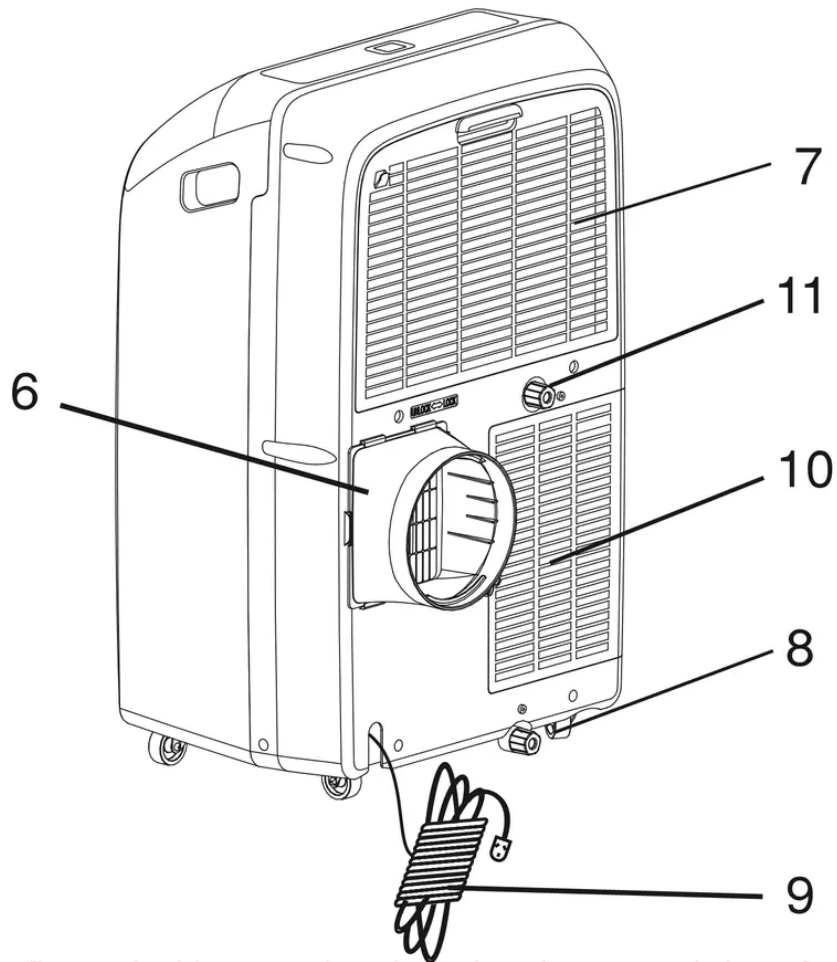

1. Cool air outlet
2. Signal receptor/Front display
3. Remote control
4. Transport handle
5. Control panel

6. Air outlet hose
7. Evaporator air intake
8. Primary drain port
9. Power cord
10. Condenser air intake
11. Secondary drain port
12. Drain hose (Heat pump models)
13. Drain hose clip (Heat pump models)

## PORTABLE AIR CONDITIONER USE

Operating your portable air conditioner properly helps you too btain the best possible results.

This section explains proper air conditioner operation.

### IMPORTANT:

- The air conditioner display shows the current room temperature.
- When changing modes while the air conditioner is in operation, the compressor will stop for 3 to 5 minutes before restarting.  
If a button is pressed during this time, the compressor will not restart for another 3 to 5 minutes.
- In Cooling or Dry mode, the compressor and condenser fan will stop when the room temperature reaches the set temperature.
- On Dry mode, the humidity level is automatically set, but is not able to be displayed.

**NOTE:** In the event of a power failure, your air conditioner will operate at the previous settings when the power is restored.

## Starting Your Portable Air Conditioner

### Control Panel

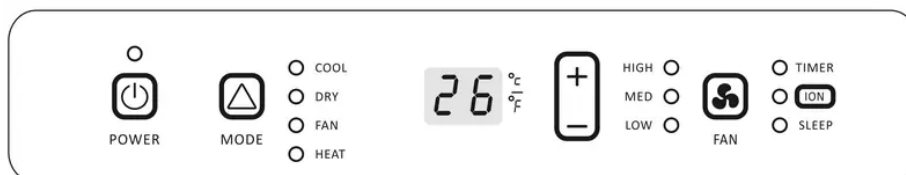

**NOTE:** The symbols may be different from these models, but the functions are similar.

### Front display

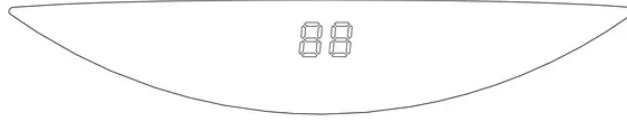

**NOTE:** The figures in this manual are based on the external view of a standard model. They may differ from that of the air conditioner you have selected.

### Power On or Off

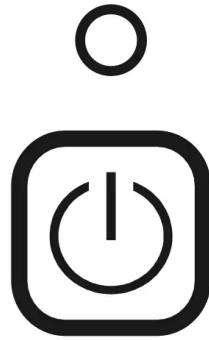

**POWER**

### NOTE:

Keep upright at least 2 hours before use to prevent damaging the compressor.

When the air conditioner is turned on for the first time after it is plugged in, it will run in the Cooling Mode (For AP14 series will run in Smart Mode). When the air conditioner is turned on at all other times, it will run according to the previous setting. Smart Mode can only be operated with the remote control.

### Mode

1. Press and release MODE until you see the symbol for the desired setting.

Operating modes:



**MODE**

2. Choose Cooling, Dry, Fan or Heating.

Cooling-Cools the room. Press Fan to select High, Mid or Low. Press the Plus or Minus button to adjust the temperature.

## COOL

Dry-Dries the room. The air conditioner automatically selects the temperature. The fan runs on Low speed only. Dehumidification ranges between 2 to 3 pints per hour, by model.

**NOTE:** Dry mode should not be used to cool the room.

## DRY

Fan Only mode. Press FAN to select High, Mid and Low.

## FAN

Heating-heats the room. Press FAN to select High, Mid and Low. Press the PLUS or MINUS button to adjust the temperature.

**NOTE:** Heating is NOT available for cooling. To cool, that mode must be selected.

## HEAT (Optional)

### Fan Speed

1. Press and release FAN to choose the desired fan speed.



FAN

2. Choose High, Mid or Low

Auto-automatically controls the fan speed depending on the current room temperature and temperature control setting.

High-for maximum fan speed.

HIGH 

Mid-for normal fan speed.

MED 

Low-for minimum fan speed.

LOW 

### Temperature

Press the PLUS button to raise the temperature. Press the PLUS button once to increase the set temperature by 1°F (1°C).



Press the MINUS button to lower the temperature. Press the MINUS button once to decrease the set temperature by 1°F (1°C).



### NOTE:

In the Cooling mode, the temperature can be set between 61°F and 86°F (16°C and 30°C).

In Fan Only mode, the temperature cannot be set.

To change the temperature display between °C and °F press both the Plus and Minus Adjust buttons at the same time.

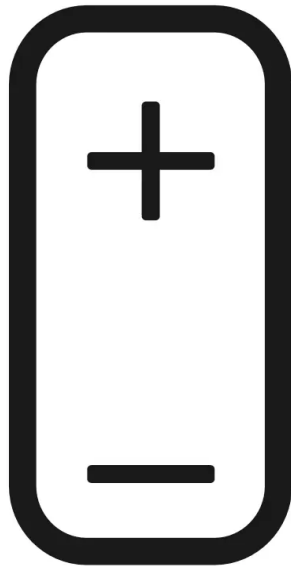

**ION (Optional)**

Press the ION button to start or stop the Plasma Generator.



When the ION indicator light of the appliance flashes, the Plasma Generator will turn on.

# REMOTE CONTROL

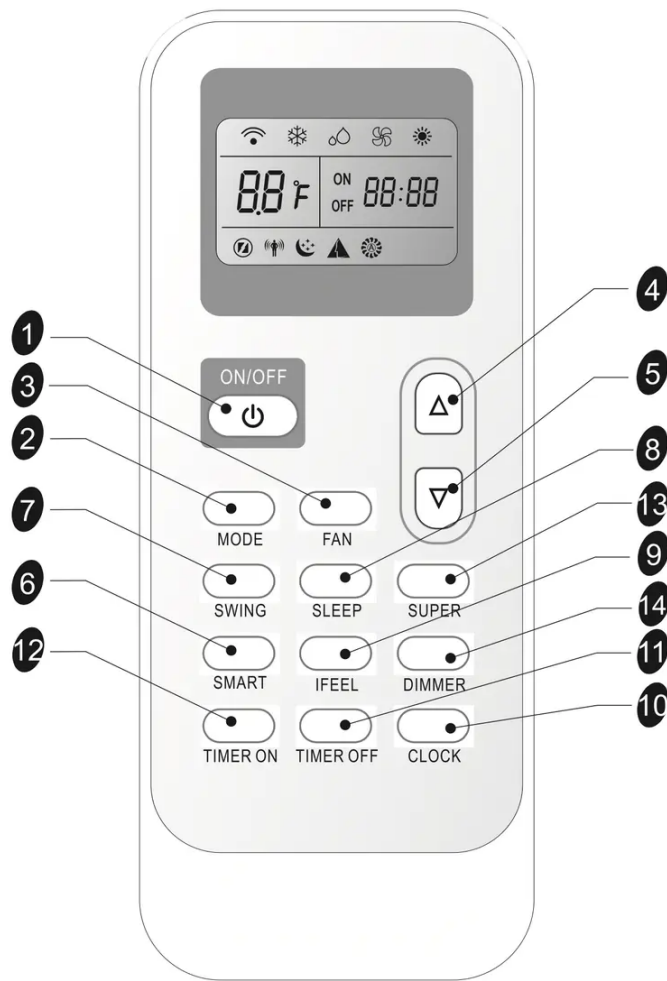

















## Button and Function

1		ON/OFF	8		SLEEP
2		MODE	9		IFEEL
3		FAN	10		CLOCK
4		UP	11		Timer Off
5		DOWN	12		Timer On
6		SMART	13		SUPER
7		SWING	14		DIMMER

**NOTE:** Your remote control could change the displaying between fahrenheit and degree centigrade by pressing MODE and DOWN buttons at the same time.

## Indication symbols

 Cooling indicator	 Auto fan speed
 Dry indicator	 High fan speed
 Fan only indicator	 Medium fan speed
 Heating indicator	 Low fan speed

 Smart indicator	 Signal transmit.
 Sleep indicator	ON  Display set timer
 Ifeel indicator	OFF  Display current time
 Super indicator	 Display set temperature

### SMART Mode

Press the SMART button, regardless. If the unit is on or off, to set temperature and fan speed automatically based on the actual room temperature.

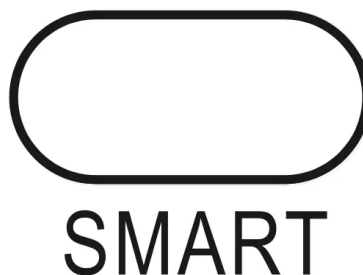

Operation mode and temperature are determined by indoor temperature.



### With Heater/Heat pump models

Indoor temperature	Operation mode	Target temperature
70°F (21°C) or below	HEATING	72°F (22°C)
70-73°F (21-23°C)	FAN ONLY	
73-79°F (23-26°C)	DRY	Room temperature decrease 4°F(2°C) after operate for 3 minutes
Over 79°F(26°C )	COOLING	79°F (26°C)

### Cooling only models

Indoor temperature	Operation mode	Target temperature
73°F(23°C ) or below	FAN ONLY	
73-79°F(23-26°C)	DRY	Room temperature decrease 4°F(2°C) after operate for 3 minutes
Over 79°F(26°C)	COOLING	79°F(26°C)

**NOTE:** Temperature, airflow and direction are controlled automatically in smart mode. However, a decrease or rise of up to 4°F (2°C) can be set with the remote controller if you still feel uncomfortable.

What you can do in ▲ mode		
Your feeling	Button	Adjustment
Uncomfortable because of unsuitable air flow volume.	 FAN	Indoor fan speed alternates among High and Low each time this button is pressed.
Uncomfortable because of unsuitable flow direction.	 SWING	Press it once, the louver swings to change airflow direction. Press it again, swings stops.

## SUPER

SUPER button is used to start or stop fast cooling or heating.

1. Press SUPER button. The air conditioner automatically sets the fan speed to High and the temperature to 61°F (16°C). Fast heating operates at auto fan speed, changing the set temperature automatically to 86°F(30°C).

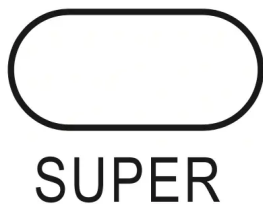

2. To turn off Super control, press any button on the remote control or control panel except Timer On, Timer Off, Clock, Dimmer, I feel and Swing.

## NOTE:

- In the SUPER mode you can set the airflow direction or timer.
- SMART and SUPER modes cannot be used simultaneously.

## fast cooling



## fast heating



### Sleep mode

SLEEP mode can only be set in Cooling, Heating or Drying. When in sleep mode the unit will utilize lower, quieter fan speeds and automatic temperature adjustments offering 8 hours of optimal sleeping conditions before shutting off.



### NOTE:

- Sleep mode cannot be used if the unit is in Smart mode.
  - The appliance will stop operation automatically after operating for 8 hours.
  - Fan speed is automatically set at low speed.
  - In the Cooling mode, if the current room temperature is below 79°F (26°C), the temperature will automatically increase 1°F (1°C) during the first hour after Sleep control is activated, and continue running at that temperature. If the room temperature is 79°F (26°C) or above, set temperature will not change.
  - In Heating mode, the set temperature will decrease by 6°F (3°C) at most, during 3 hours, and continues running at that temperature until auto shut off.
1. Press MODE to select Cooling, Heating or Dry.  
**NOTE:** Sleep control cannot be selected in Fan mode.
  2. Press the UP or DOWN button to set the temperature.
  3. Press SLEEP. After 5 seconds, the lights on the control panel display will dim.  
**NOTE:** The temperature and airflow direction may be adjusted during Sleep control. The fan speed is automatically set to Low speed. After 5 seconds, the lights on the control panel display will dim again.

4. To turn off Sleep control, press SLEEP, MODE, ON/OFF, FAN, SUPER or wait 8 hours for Sleep control to turn off automatically.

**NOTE:** The air conditioner will return to previous settings after Sleep mode is turned off.

## I FEEL

The temperature sensor built into the remote control can sense its surrounding temperature, and transmit the signal back to the unit. The temperature is adjusted to provide maximum comfort.

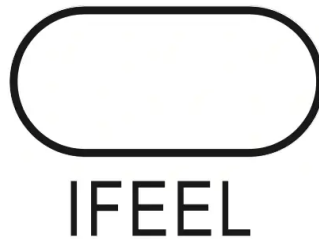

### NOTE:

- The I FEEL function is active, as a default setting from the factory
- To de-activate the I FEEL function, press the I FEEL button for about 5 seconds, and the I FEEL indicator in the display will disappear, de-activating the I FEEL function.



- Pressing the I FEEL button once will activate I FEEL function again.

## DIMMER

Press the DIMMER button to turn off the control panel display.



# DIMMER

**NOTE:** When in DIMMER mode, new control inputs will return display to normal.

## Clock function

1. You can set the real time by pressing the CLOCK button.



# CLOCK

2. Use the Up and Down buttons to set the correct time.



3. Press the CLOCK button again and the real time is set.

## TIMER ON/OFF

Set the timer with the TIMER ON/OFF buttons.

**NOTE:** The CLOCK must be set before using the TIMER function.



## Using the TIMER

The TIMER ON button can be used to turn on the unit automatically at a preset time.

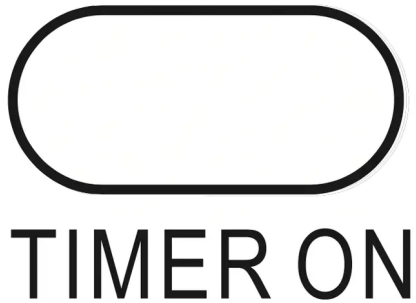
1. Press TIMER ON, then "On 12:00" flashes on the LCD.



2. Press the UP or DOWN button to set the time of day to turn on the appliance.

-  Increase
-  Decrease



Press the UP or DOWN button once to increase or decrease the time setting by 1 minute.

Press and hold the UP or DOWN button for 2 seconds to increase or decrease the time setting by 10 minutes.

Press and hold the UP or DOWN button for a longer time to increase or decrease the time setting by 1 hour.

3. When the desired time is displayed on the LCD, press theTIMER ON button to confirm it. A "Beep" will be heard, and "ON" stops flashing. The TIMER indicator on the appliance lights up, indicating the TIMER is set.
4. After the preset time is displayed for 5 seconds, the clock will display on the LCD of remote controller instead of the TIMER setting.

### To cancel TIMER On

Press the TIMER ON button again, when a "beep" is heard and the indicator disappears, the TIMER ON mode has been canceled.

TIMER OFF is set exactly the same way as TIMER ON. However, TIMER OFF is set when the unit is running, and sets the time at which the unit will turn off.



**TIMER OFF**

### **SWING**

Press SWING once to change the vertical airflow direction. Press again to hold the louver in a desired position.



**SWING**

### **NOTE:**

- Airflow is automatically adjusted to a preset direction after turning on the unit.
- The direction of airflow can be adjusted by pressing the SWING button.
- Do not turn the airflow louvers manually, to prevent damage, turn off the unit first and cut off the power supply. Then restore power again after adjustment.

### **Normal Sounds**

When your air conditioner is operating normally, you may hear sounds such as:

- Air movement from the fan.
- Clicks from the thermostat cycling.
- Vibration or noise due to poor wall or window construction.
- A high-pitched hum or pulsating noise caused by the high-efficiency compressor cycling on and off.

# PORTABLE AIR CONDITIONER CARE

## Draining the Air Conditioner

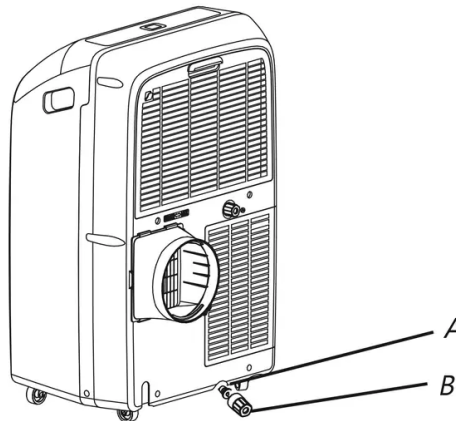

A.Primary drain cover B.Primary drain plug

### **WARNING - Excessive Weight Hazard**

- Use two or more people to move and install the air conditioner.
  - Failure to do so can result in back or other injury.
1. Unplug the air conditioner or disconnect power.
  2. Move the air conditioner to a drain location or outside.  
**NOTE:** To avoid leaking water from the unit, move the air conditioner slowly and keep it level.
  3. Remove the primary drain cover and plug.
  4. Drain water completely through the drain hole.  
**NOTE:** If the air conditioner will be stored after use, see "Storing After Use".
  5. Reinstall the drain plug to the primary drain hole.
  6. Reinstall the primary drain cover to the drain hole.
  7. Reposition the air conditioner.
  8. Plug in the air conditioner or reconnect power.

## Draining the Air Conditioner (Heating mode)

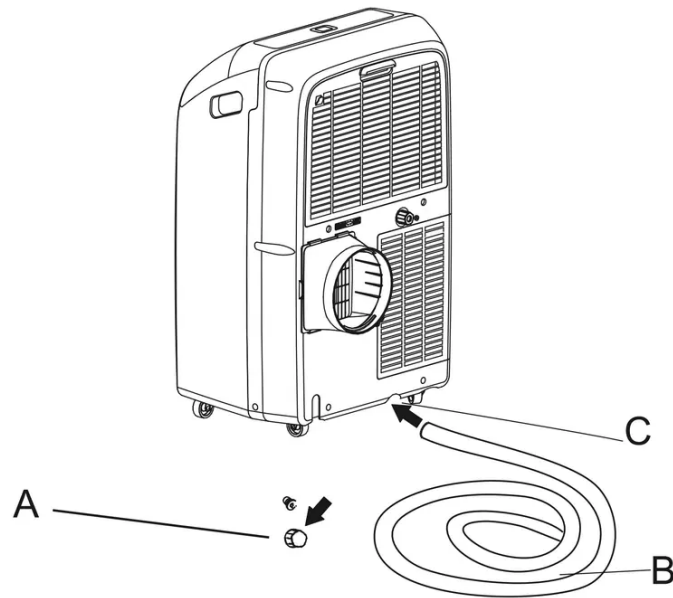

- A. Primary drain port
- B. Drain hose
- C. Primary drain hole

**WARNING:** Please connect the drain hose on heating mode, or the unit will stop running after the water reaches warning level.

1. Uncover the primary drain port.
2. Attach the drain hose to the primary drain hose.  
Make sure the connector is no water leak.
3. Place the other end of drain hose into a outfall. Check to see that the hose lies flat and is in the drain. Make sure the hose end that gose to the drain is on a lower level than the hose end that connects to the unit. The hose should not be kinked or pinched.

## Cleaning the Outside

1. Press ON/OFF to turn off the air conditioner.
2. Unplug the air conditioner or disconnect power.
3. Remove the air filter and clean separately. See "cleaning theAir Filter".
4. Wipe the outside of the air conditioner with a soft, damp cloth.
5. Plug in the air conditioner or reconnect power.
6. Press ON/OFF to start the air conditioner.

## Cleaning the Air Filter

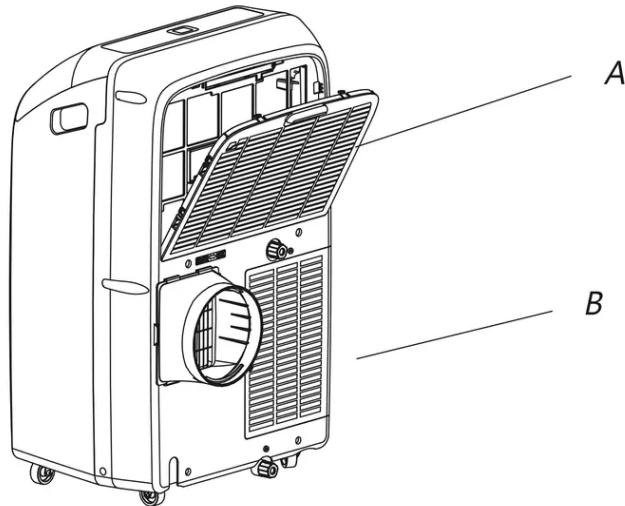

A. Evaporator air intake filter panel door  
B. Condenser air intake filter panel door

1. Press ON/OFF to turn off the air conditioner.
2. Open the filter panel door on the back of the air conditioner and remove.
3. Remove the tapping screw from the condenser air intake filter panel door and remove.
4. Use a vacuum cleaner to clean the filter. If the filter is very dirty, wash the filter in warm water with a mild detergent.  
**NOTE:** Do not wash the filter in the dishwasher or use any chemical cleaners.
5. Air dry the filter completely before replacing to ensure maximum efficiency.
6. Reattach the air filter to the filter panel door.
7. Reinstall the filter panel door and tapping screw.
8. Press ON/OFF to start the air conditioner.

## Storing After Use

1. Drain the water completely. See "draining the AirConditioner".
2. Run the air conditioner set to Fan Only for approximately 12 hours to dry the air conditioner.
3. Unplug the air conditioner.
4. Remove the flexible exhaust hose and store with the air conditioner in a clean, dry area. See "Installation Instructions".
5. Remove the window kit and store with the air conditioner in a clean, dry area. See "Installation Instructions".
6. Remove the filter and clean. See Cleaning the Air Filter.
7. Clean the outside of the air conditioner. See "Cleaning the Outside".

8. Reinstall the filter.
9. Remove the batteries and store the remote control with the air conditioner in a clean, dry area.

## **TROUBLESHOOTING**

Before calling for service, please try the suggestions below.

### **Air conditioner will not operate**

#### **WARNING - Electrical Shock Hazard**

Plug into a grounded 3 prong outlet.

Do not remove ground prong.

Do not use an adapter.

Do not use an extension cord.

Failure to follow these instructions can result in death, fire, or electrical shock.

- **The power supply cord is unplugged.**  
Plug into a grounded 3 prong outlet. See "Electrical Requirements."
- **Time-delay fuse or circuit breaker of the wrong capacity is being used.**  
Replace with a time-delay fuse or circuit breaker of the correct capacity. See "Electrical Requirements".
- **The power supply cord has tripped (Reset button has popped out).**  
Press and release RESET (listen for click; Reset button will latch and remain in) to resume operation.
- **A household fuse has blown, or a circuit breaker has tripped.**  
Replace the fuse, or reset the circuit breaker. See "Electrical Requirements".
- **The On/Off button has not been pressed.**  
Press ON/OFF.
- **The local power has failed.**  
Wait for power to be restored.

### **Air conditioner blows fuses or trips circuit breakers**

- **Too many appliances are being used on the same circuit.**  
Unplug or relocate appliances that share the same circuit.
- **You are trying to restart the air conditioner too soon after turning off air conditioner.**  
Wait at least 3 minutes after turning off air conditioner before trying to restart the air conditioner.

## **Air conditioner power supply cord trips (Reset button pops out)**

- **Disturbances in your electrical current can trip (Reset button will pop out) the power supply cord.**

Press and release RESET (listen for click; Reset button will latch and remain in) to resume operation.

- **Electrical overloading, overheating, cord pinching or aging can trip (Reset button will pop out) the power supply cord.**

After correcting the problem, press and release RESET (listen for click; Reset button will latch and remain in) to resume operation. If the power cord fails to reset, contact a service technician.

**NOTE:** A damaged power supply cord must be replaced with a new power supply cord obtained from the product manufacturer and must not be repaired.

## **Air conditioner seems to run too much**

- **Is there a door or window open?**

Keep doors and windows closed.

- **The current air conditioner replaced an older model.**

The use of more efficient components may cause the air conditioner to run longer than an older model, but the total energy consumption will be less. Newer air conditioners do not emit the “blast” of cold air you may be accustomed to from older units, but this is not an indication of lesser cooling capacity or efficiency. Refer to the efficiency rating (EER) and capacity rating (in Btu/h) marked on the air conditioner.

- **The air conditioner is in a heavily occupied room, or heat-producing appliances are in use in the room.**

Use exhaust vent fans while cooking or bathing and try not to use heat-producing appliances during the hottest part of the day. Portable air conditioners are designed as supplemental cooling to local areas within a room. A higher capacity air conditioner may be required, depending on the size of the room being cooled.

## **Air conditioner runs for a short time only, but room is not cool**

- **Set temperature is close to room temperature.**

Lower set temperature. See "Portable Air Conditioner Use".

## **Display error code**

- **If the unit displays error code E5, the water container is full.**

**Drain the water, see “Draining the air conditioner”. After draining, the unit can be operated again.**

- If the unit displays error code E1/E2/E3/E4/E6/E7/EA, please contact customer service.

## Air conditioner runs, but does not cool

- **The filter is dirty or obstructed by debris.**  
Clean the filter.
- **Air outlet is blocked.**  
Clear air outlet.
- **Set temperature is too high.**  
Lower set temperature.

## Air conditioner cycles on and off too much

- **The air conditioner is not properly sized for your room.**  
Check the cooling capabilities of your portable air conditioner. Portable air conditioners are designed as supplemental cooling to local areas within a room.
- **The filter is dirty or obstructed by debris.**  
Clean the filter.
- **There is excessive heat or moisture, open container cooking, showers, etc. in the room.**  
Use a fan to exhaust heat or moisture from the room. Try not to use heat-producing appliances during the hottest part of the day.
- **The louvers are blocked.**  
Install the air conditioner in a location where the louvers are free from curtains, blinds, furniture, etc.

### Warning

This content is compiled from multiple sources and is provided for reference purposes only. It may not be complete or fully applicable to all situations. If you are unable to resolve your issue, please contact the product manufacturer or an authorized service provider for official support.