

## Getting to know your appliance

Diagrams of the control panel and the interior of the appliance can be found at the front of the manual. Individual positions are referred to in the text.

### Control panel

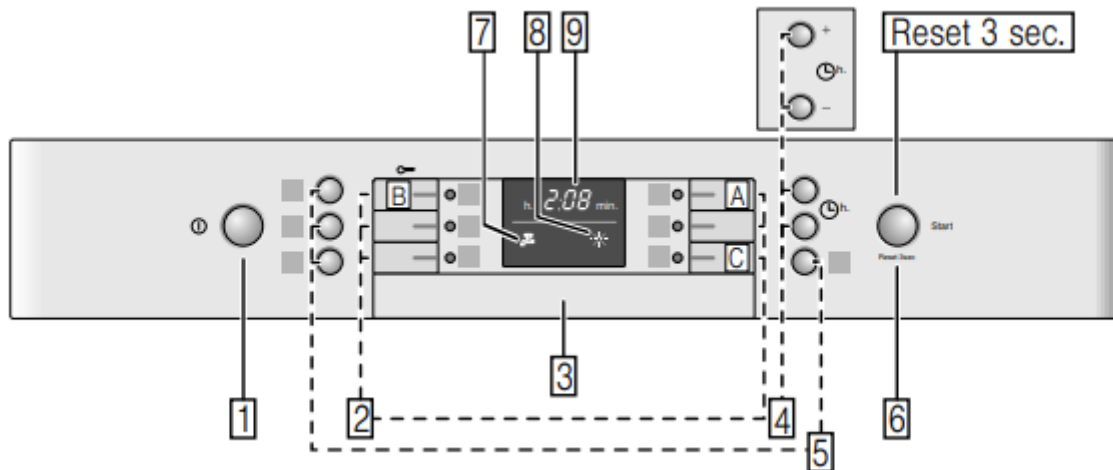

- 1 On/off switch
- 2 Programme buttons \*\*
- 3 Door opener
- 4 Time preselection
- 5 Additional functions/programme buttons \*\*
- 6 START button
- 7 Display "Check water supply"
- 8 Rinse aid refill indicator
- 9 Display window

\* depending on the features of your dishwasher

\*\*number depending on the features of your dishwasher

## Appliance interior

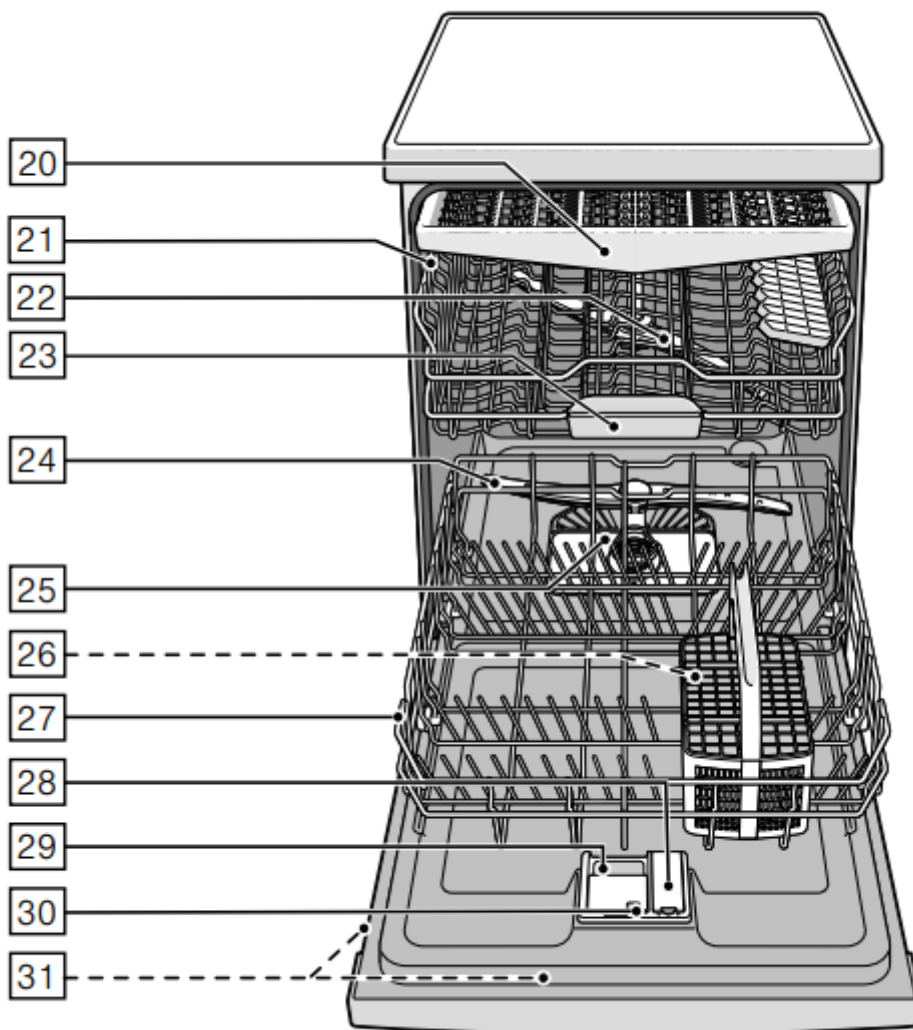

- 20 Cutlery drawer \*
- 21 Top basket
- 22 Upper spray arm
- 23 Tablet collecting tray
- 24 Lower spray arm
- 25 Filters
- 26 Cutlery basket \*
- 27 Bottom basket
- 28 Dispenser for rinse aid
- 29 Detergent dispenser
- 30 Lock for detergent dispenser
- 31 Rating plate

\*depending on the features of your dishwasher

### Overview of menu

The dishwasher has been preset with certain settings for your convenience.

The settings can be found in the individual chapters. You can change these factory settings.

Setting up	Factory setting	Description
<i>r</i> Rinse aid <i>r:00 - r:05</i>	<i>r:05</i>	Amount of rinse aid affects drying. When using Multitabs, select setting 0.
<i>d</i> ExtraDry <i>d:00 - d:01</i>	<i>d:00 / Off</i>	Improved drying for glasses and plastic tableware.
<i>R</i> Hot water * <i>R:00 - R:01</i>	<i>R:00 / Off</i>	The dishwasher can be connected to either hot (40-60°C) or cold water (<40°C).
<i>P</i> Auto Power Off <i>P:00 - P:02</i>	<i>P:01</i>	Appliance automatically switches off at the end of each wash.

\* depending on the configuration of your specific dishwasher

### Rinse aid

Rinse aidThe rinse aid ensures stain-free dishes and clear glasses. Use only rinse aid for domestic dishwashers. As soon as the rinse aid refill indicator 8 lights up in the control panel, there is still a rinse aid reserve of 1-2 rinse cycles. Top up the rinse aid.

### Top up the rinse aid as follows:

1. Open dispenser **28**; press lug on the lid (1) and lift (2).

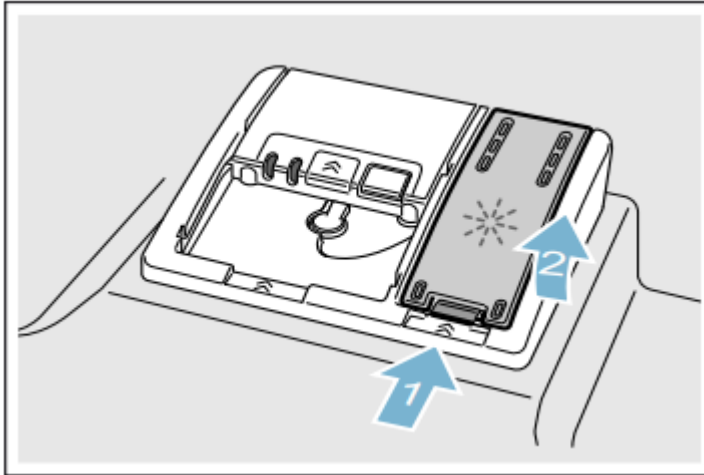

2. Add rinse aid up to the max. mark.

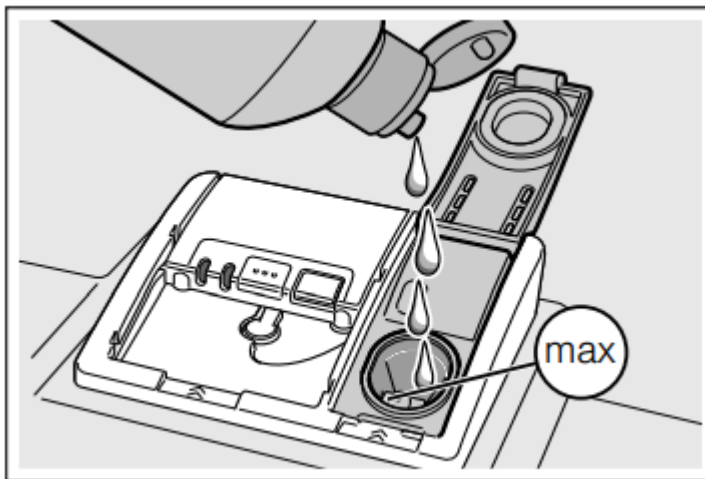

3. Close the lid.  
The lid "clicks" into position.
4. Remove overflowed rinse aid with a cloth.  
This prevents excessive frothing during the next rinse cycle.

### Setting amount of rinse aid

You can set the amount of rinse aid that should be added to a value between **r:00** and **r:06**. Setting the amount of rinse aid to be dispensed to **r:05** will give you a very good drying result. The factory setting is **r:05**. Do not change the amount of rinse aid unless there are streaks or water stains on the utensils.

Set a lower level to avoid streaks. Set a higher level to avoid water stains.

### Here's how to set the amount of rinse aid:

1. Switch on ON/OFF switch  1.
2. Hold down the programme button  A and then repeatedly press the SSTART button  6 until **d:0...** appears in the display window.
3. Release both buttons.
4. Press the programme button  A repeatedly until the factory setting value **r:05** appears in the display window h.
5. Press the programme button 3.
6. Each time the button is pressed, the set value increases by one level; when it reaches the value **r:06** the display jumps back to **r:00** (Off).
7. Press START button  6.  
The set value is saved.

### Using detergent with a rinse aid component

In general, you can use detergent with a rinse aid component up to a water hardness level of 21 °dH (37 °fH, 26° Clark, 3.7 mmol/L) without adding rinse aid. Above a water hardness value of 21 °dH, use additional rinse aid.

### Switching off rinse aid refill indicator

If the rinse aid refill indicator  8 bothers you (e.g. if you are using a combination detergent with a rinse aid component), you can switch off the rinse aid refill indicator.

Proceed as described under "Setting rinse aid quantity" and set the level to **r:00**. The rinse aid refill indicator  8 is switched off.

## Utensils

### Not suitable

- Cutlery and utensils made of wood.
- Delicate decorative glasses, craft and antique utensils. These decors are not dishwasher-proof.
- Plastic parts not resistant to heat.
- Copper and tin utensils.
- Utensils which are soiled with ash, wax, lubricating grease or ink.

Aluminium and silver parts have a tendency to discolour and fade during the wash cycle. Even some types of glass (e.g. crystal glass objects) may turn cloudy after many wash cycles.

### **Glass and utensil damage**

#### **Causes:**

- Glass type and glass production process.
- Chemical composition of the detergent.
- Water temperature of the wash programme.

#### **Recommendation:**

- Use only glasses and porcelain which the manufacturer designates as dishwasher-proof.
- Use a detergent which protects utensils.
- Take glass and cutlery out of the dishwasher as soon as possible after the programme ends.

### **Loading the dishwasher**

1. Remove large food remnants. It is not necessary to prerinse utensils under running water.
2. Place the utensils so that
  - they are secure and cannot tip over.
  - all utensils with their openings face down.
  - parts with curves or indentations are at an angle, thereby allowing water to drain.
  - does not obstruct rotation of the two spray arms 22 and 24.

Very small utensils should not be washed in the machine, as they may fall out of the baskets.

#### **Upper basket**

Arrange cups and glasses in the upper basket 21

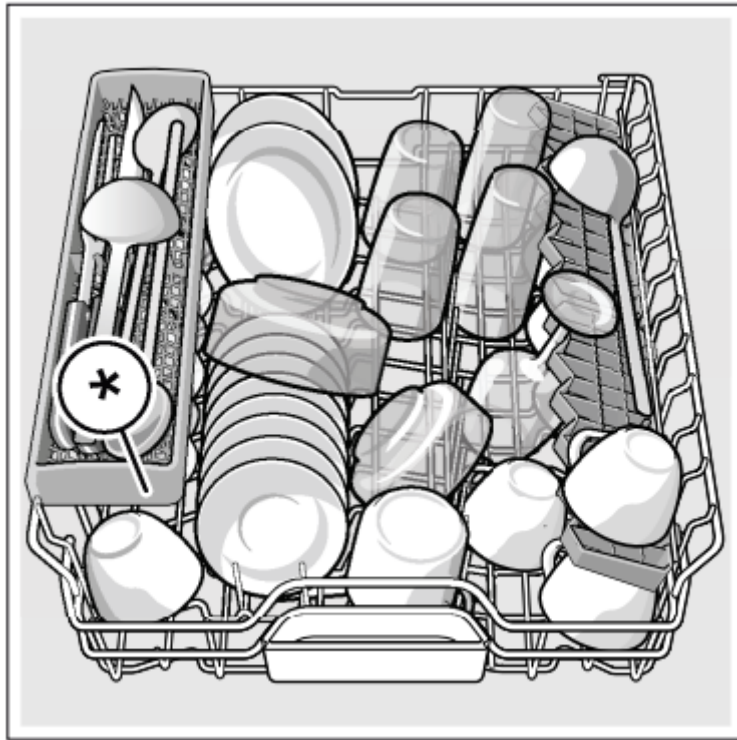

\*. depending on the features of your dishwasher

**Note:** Utensils must not be placed above the tablet collecting tray **23**.

These may block the lid of the detergent dispenser and prevent it from opening fully.

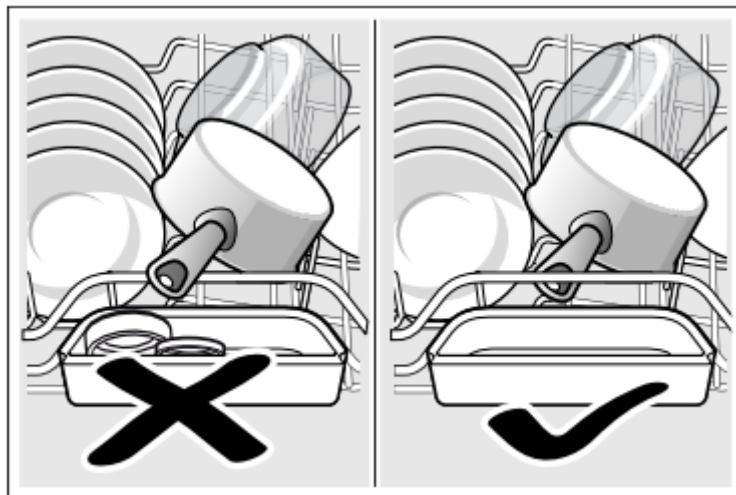

#### Lower basket

Arrange pots and plates in the lower basket **27**.

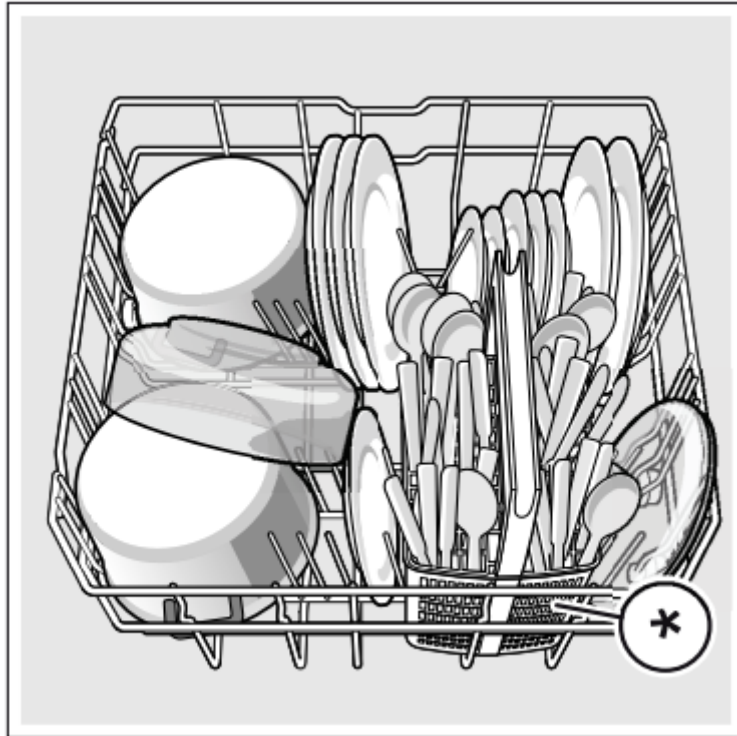

\*depending on the features of your dishwasher

**Tip:** Heavily soiled utensils (pans) should be placed in the lower basket. The more powerful spray jet provides a better dishwashing result.

**Tip:** Other examples, such as the best way of loading your dishwasher, can be found on our homepage. These can be downloaded free of charge. The corresponding Internet address can be found on the back page of these instructions for use.

### Cutlery basket \*

Cutlery basket: Place cutlery, always unsorted with the tips face down, in the cutlery basket \*.

To prevent injuries, place long, pointed implements and knives on the knife shelf \*.

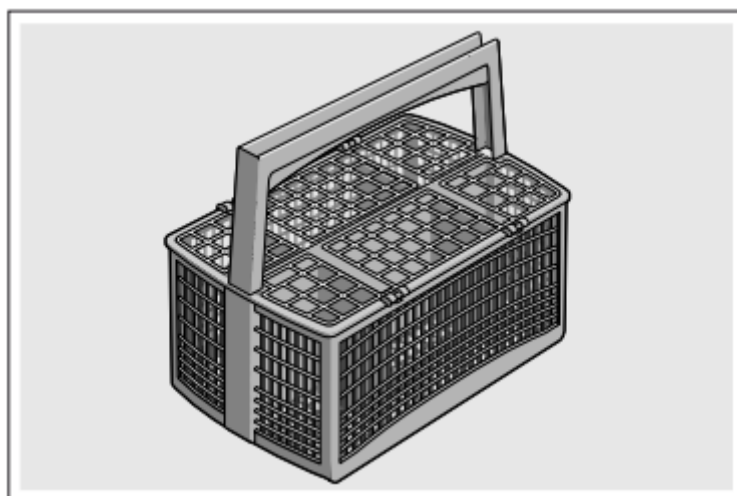

\* depending on the features of your dishwasher

### Cutlery drawer \*

Arrange the cutlery in the cutlery drawer **20** as illustrated. Separately arranged utensils are easier to remove after washing.

You can take out the cutlery drawer.

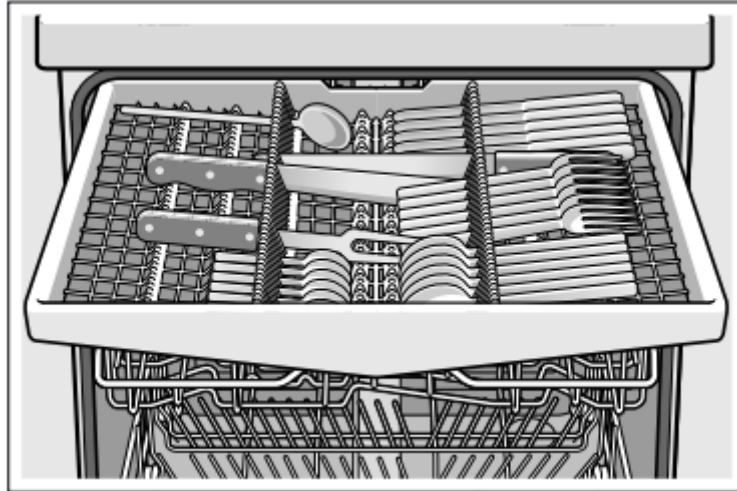

Depending on the features of your dishwasher, you can fold down the side shelves to provide more room for taller items of cutlery. The front rows of prongs can be folded down to provide room for wider handles.

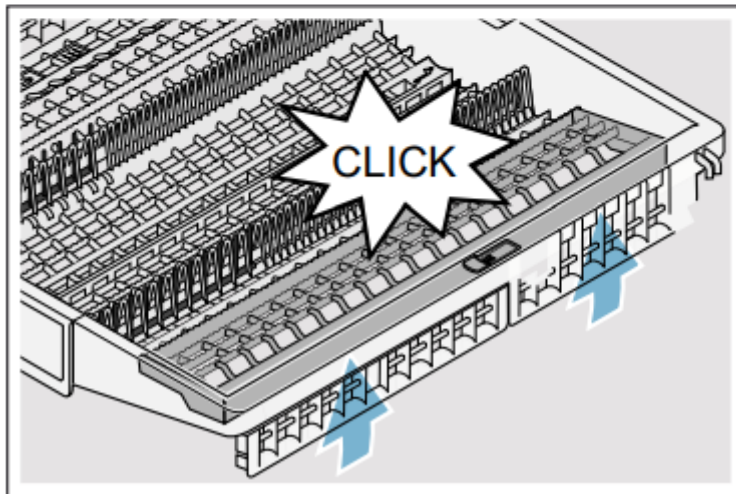
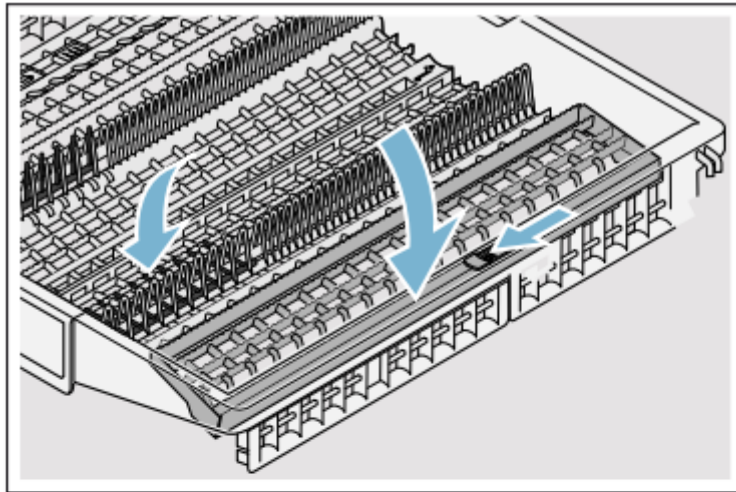

\*depending on the features of your dishwasher

### Etagere \*

The etagere and the space underneath can be used for small cups and glasses or for larger items of cutlery, such as wooden spoons or serving cutlery. If you do not require the etagere, it can be folded up.

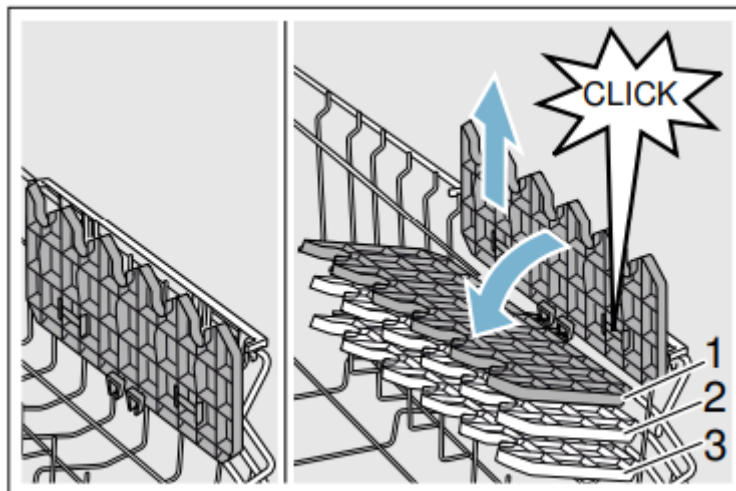

\*Depending on the features of your dishwasher, you can adjust the etagere 3 times the height.

### **Adjust the height of the etagere as follows:**

1. Position the etagere vertically and pull upwards.
2. Push etagere at a slight angle downwards to the required height or (1, 2, or 3).
3. Engage etagere.  
Etagere “clicks” into position.

### **Folding spikes \***

\* Depending on the features of your dishwasher, the spikes can be folded down. This facilitates arrangement of pots, bowls and glasses.

### **Fold down the spikes as follows:**

1. Press lever forwards (1).
2. Fold down spikes (2).

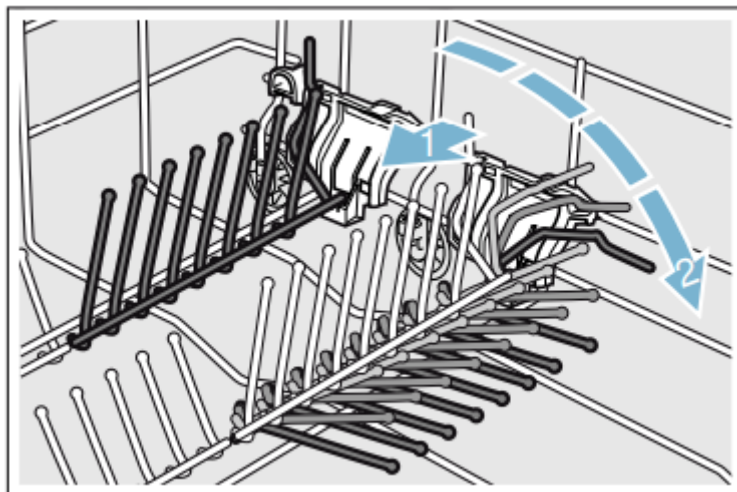

### **Small items holder \***

\* Depending on the features of your dishwasher, the upper basket is fitted with small items holders. The small items holders can be used to securely attach light plastic parts.

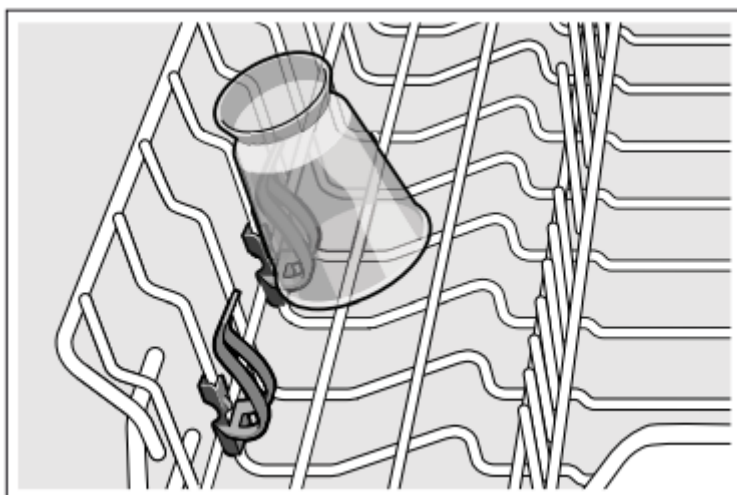

### Knife rack \*

\* Depending on the features of your dishwasher, the upper basket is fitted with a knife shelf. Long knives and other utensils can be placed in the knife shelf.

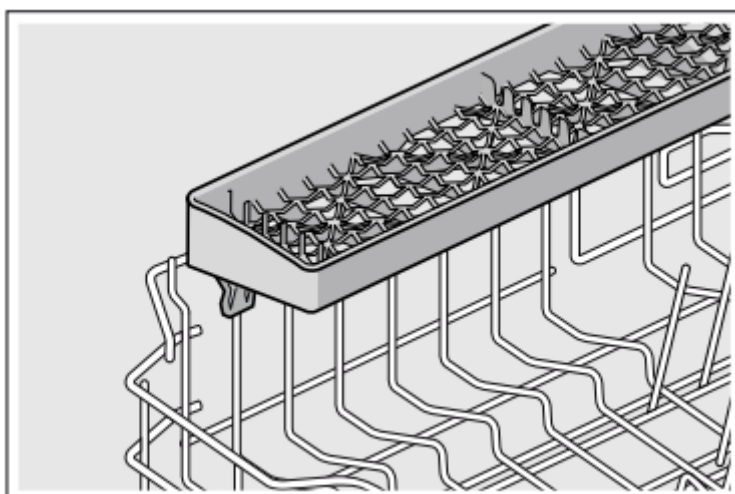

### Baking sheet spray head \*

\* depending on the features of your dishwasher

Large trays or grilles as well as large plates (gourmet plates, pasta plates, dinner plates) can be cleaned with this spray head.

**Insert the spray head as follows:**

1. Remove upper basket 21.
2. Insert spray head as illustrated and turn to the right.  
Spray head is engaged

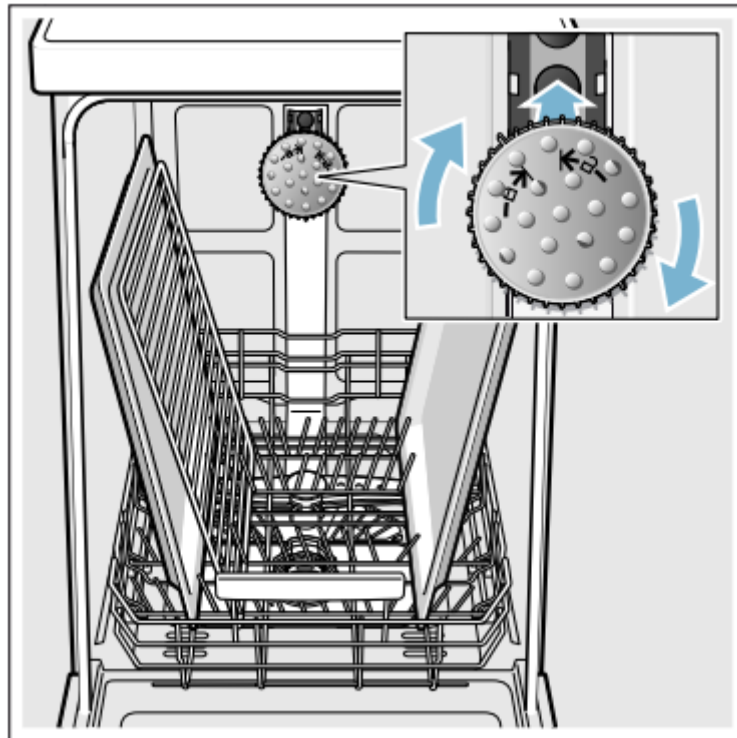

To ensure that the spray jet can reach all parts, arrange the baking sheets as illustrated (max. 2 baking sheets and 2 grilles).

**Note:** Ensure that the dishwasher is always operated with upper basket **21** or baking tray spray head

### Unloading the dishwasher

To prevent water from dripping off the upper basket onto the utensils in the lower basket, it is recommended to empty the appliance from the bottom up.

**Tip:** Hot utensils are sensitive to shock! Therefore, when the programme ends, leave the utensils to cool down in the dishwasher until they can be handled.

**Note:** When the programme ends, water droplets can still be seen inside the appliance. This does not affect the drying of the utensils.

### Adjusting the height of the basket \*

\* depending on the features of your dishwasher

If required, the height of the upper basket **21** can be adjusted to create more space for taller utensils either in the upper or lower basket

**Appliance height 81.5 cm**

With cutlery basket	Upper basket	Lower basket
Setting 1 max. $\emptyset$	22 cm	31 cm
Setting 2 max. $\emptyset$	24.5 cm	27.5 cm
Setting 3 max. $\emptyset$	27 cm	25 cm

With cutlery drawer	Upper basket	Lower basket
Setting 1 max. $\emptyset$	16 cm	31 cm
Setting 2 max. $\emptyset$	18.5 cm	27.5 cm
Setting 3 max. $\emptyset$	21 cm	25 cm

#### Appliance height 86.5 cm

With cutlery basket	Upper basket	Lower basket
Setting 1 max. $\emptyset$	24 cm	34 cm
Setting 2 max. $\emptyset$	26.5 cm	30.5 cm
Setting 3 max. $\emptyset$	29 cm	28 cm

With cutlery drawer	Upper basket	Lower basket
Setting 1 max. $\emptyset$	18 cm	34 cm
Setting 2 max. $\emptyset$	20.5 cm	30.5 cm
Setting 3 max. $\emptyset$	23 cm	28 cm

Arrange large plates up to a diameter of 31/34\* cm in the lower basket 27 as illustrated.

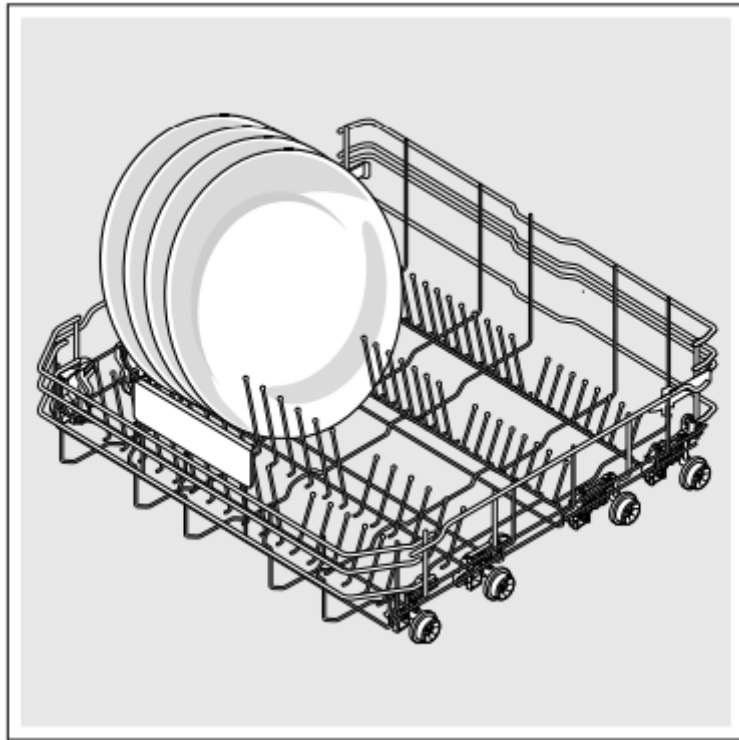

\* depending on the features of your dishwasher

### Upper basket with side levers

1. Pull out upper basket **21**.
2. Hold the sides of the basket along the upper edge. This prevents it from suddenly dropping.
3. To lower the upper basket; press in both levers on the left and right on the outside of the basket. The upper basket lowers.

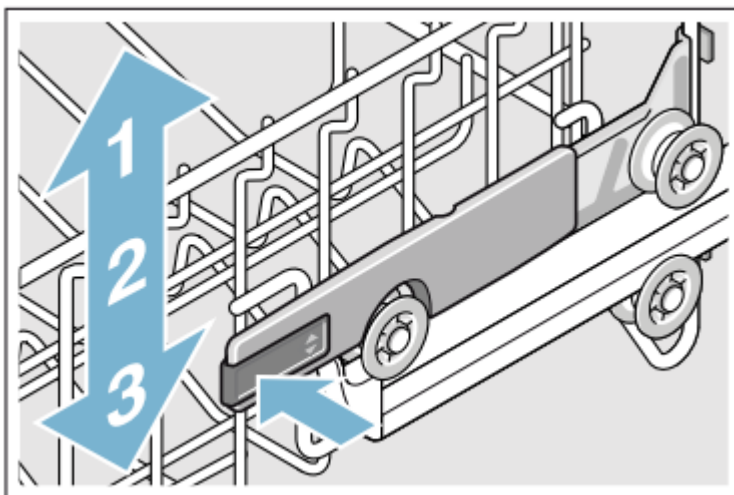

4. To lift the upper basket; grip the sides of the upper basket along the upper edge and lift.
5. Ensure that both sides of the upper basket are at the same height.
6. Push in upper basket.

### Upper basket with upper and lower pairs of rollers

1. Pull out upper basket **21**.
2. Remove upper basket.
3. Re-attach upper basket to the upper (Setting 3) or lower (Setting 1) rollers.

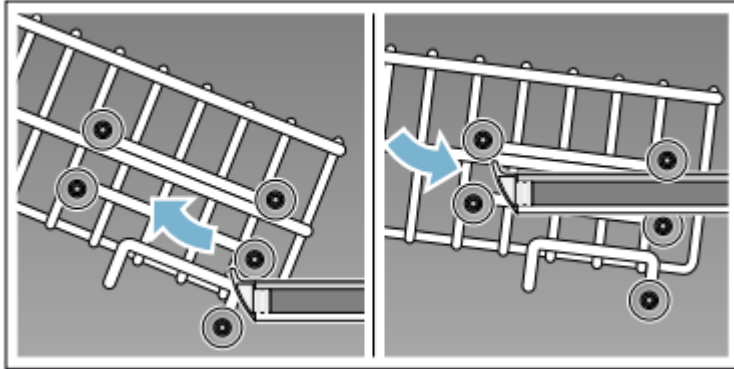

4. Push in upper basket.

## Detergent

You can use tablets as well as powder or liquid detergents for dishwashers, but never use washing-up liquid. The dosage can be individually adjusted with powder or a liquid detergent according to the degree of soiling.

Tablets contain an adequately large amount of active ingredients for all cleaning tasks. Modern, powerful detergents predominantly use a low-alkaline formulation with enzymes.

Enzymes break down starch and remove protein. To remove coloured stains (e.g. tea, ketchup), oxygen-based bleaching agents are generally used.

**Note:** To ensure a good washing result, always follow the instructions on the detergent packaging!

If you have further questions, we recommend that you contact the detergent manufacturers' helplines.

### Warning

**Risk of injury and damage due to non-observance of the safety instructions for detergent and rinse-aid products!**

Always follow the safety instructions for detergent products and rinse-aid products

### Adding detergent

1. If the detergent dispenser **29** is still closed, actuate locking bar **30** to open it.
2. Pour detergent into the dry detergent dispenser **29** only (insert tablet flat, not on its edge).

3. Dosage: see manufacturer's instructions on the packaging. Use graduated detergent dispenser. Usually 20 ml–25 ml are adequate for normal soiling. If using tablets, one tablet is adequate.

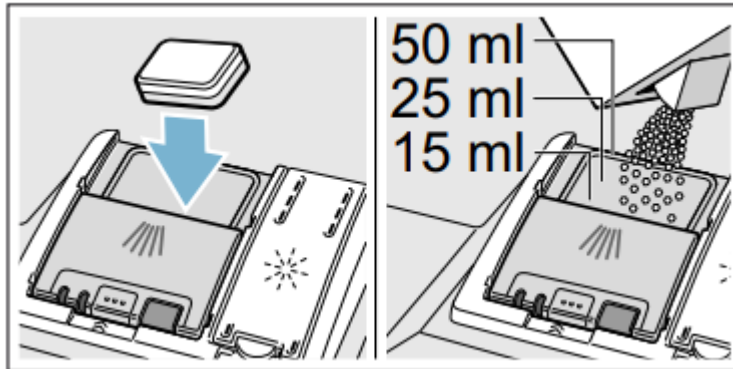

4. Close cover on the detergent dispenser. Cover “clicks” into position.

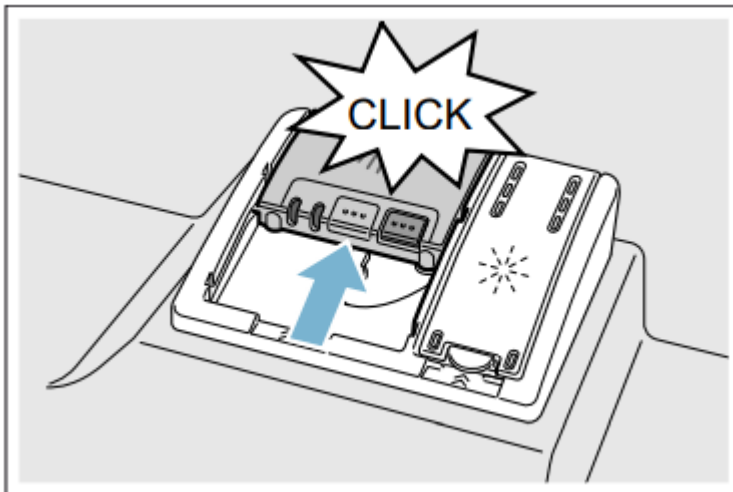

The detergent dispenser opens automatically at the optimum time depending on the programme. The powder or liquid detergent is distributed in the appliance and is dissolved, the tablet falls into the tablet collecting tray where it dissolves in doses.

**Tip:** If the utensils are only lightly soiled, slightly less than the indicated amount of detergent is usually adequate.

Suitable detergents and care products can be purchased online via our website or via customer service (see back page).

#### Notes



- If programmes are short, tablets may not have full cleaning effect due to different dissolving properties and there may even be undissolved detergent residue. It is recommended to use washing powder for these programmes.
- The Intensive programme (on some models) requires one tab only. When using washing powder, you can apply some of this cleaning agent to the inside of the appliance's door.



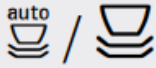
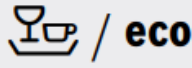

- If using detergents in a water-soluble protective cover: Take hold of the cover with dry hands only and put the detergent into an absolutely dry detergent dispenser only, otherwise the detergent may stick.
- If you switch from combined detergents to solo detergents, ensure that the water softening system \* and amount of rinse aid have been set to the correct value. depending on the features of your dishwasher

## Overview of programmes

The max. possible number of programmes is illustrated in this overview. The corresponding programmes for your appliance can be found on the fascia. The programme data has been measured in the laboratory according to AS/NSZ 2007.

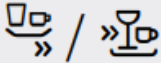
**Note:** The consumption figures depend on the selected programme and additional functions. The programme duration will be different if the machine is short of rinse additive or the function is turned off.

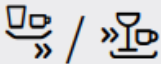
Type of utensils and soiling	Programme	Programme data 1.) Duration: hs/mins 2.) Energy consumption in kWh 3.) Water consumption in litres 4.) With Aquasensor	Possible additional options	Programme sequence
Pots, utensils and cutlery Highly soiled	 Auto Intensive 65° - 75°	1.) <b>1:40 - 2:15</b> 2.) <b>1,30 - 1,60</b> 3.) - 4.) <b>11 - 15</b>	all	<b>Sensor-controlled:</b> Is optimised according to the soiling with the aid of sensors.
Utensils and cutlery Normally soiled	 Auto Wash 45° - 65°	1.) <b>1:30 - 2:40</b> 2.) <b>0,95 - 1,60</b> 3.) - 4.) <b>7 - 18</b>	all	
Utensils and cutlery Normally soiled	 Eco Wash 45°	1.) <b>2:50</b> 2.) <b>0,64</b> 3.) <b>12</b> 4.) -	all	<b>Most economical programme:</b> Prerinse Clean 45° Intermediate rinse Final rinse 45° Dry
sensitive utensils, cutlery, temperature-sensitive plastic and glasses slightly adhesive, fresh food remnants	 Glass Wash 40°	1.) <b>1:25 - 1:30</b> 2.) <b>0,85 - 0,90</b> 3.) <b>14</b> 4.) <b>11</b>	IntensivZone Speed Perfect Half load Extra Dry	<b>Particularly gentle:</b> Pre-rinse Clean 40° Intermediate rinse Final rinse 60° Drying

Type of utensils and soiling	Programme	Programme data 1.) Duration: hs/mins 2.) Energy consumption in kWh 3.) Water consumption in litres 4.) With Aquasensor	Possible additional options	Programme sequence
Utensils and cutlery Normally soiled	 /  Quick 60 min. 65°	1.) <b>1</b> 2.) <b>1,30</b> 3.) <b>10</b> 4.) -	Extra Dry	<b>Time-optimised:</b> Clean 65° Intermediate rinse Final rinse Dry
Utensils and cutlery Lightly soiled	 /  Quick 29 min. 45°	1.) <b>0:29</b> 2.) <b>0,80</b> 3.) <b>10</b> 4.) -	Extra Dry	<b>Time-optimised:</b> Clean 45° Intermediate rinse Final rinse 55°
-	 / <b>Easy Clean</b> Machine Care	1.) <b>1:30</b> 2.) <b>0,90 - 1,06</b> 3.) <b>9,5 - 12,5</b> 4.) -	none	<b>Machine cleaning cycle 70°</b>

### Programme selection

You can select a suitable programme according to the type of utensils and type of soiling.

### Information for test institutes

Test institutes can request the conditions for running comparison tests by sending an e-mail to [dishwasher@test-appliances.com](mailto:dishwasher@test-appliances.com). Quote the appliance number (ENr.) and the production date (FD) which you can find on the rating plate  on the appliance door.

### Additional functions

\* Depending on the features of your dishwasher, you can select different additional functions

.



### Speed Perfect \*

This function can reduce the running time by approx. 20% to 50% depending on the selected rinse programme. To obtain optimum cleaning and drying results at a reduced running time, water and energy consumption are increased.



If you have only a few items to wash e.g. glasses, cups, plates), you can switch to “half load”. This will save water, energy and time. It is recommended to put a little less detergent in the detergent dispenser than for a full load.

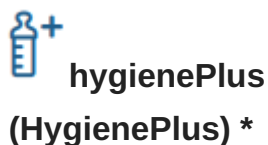

This function increases the temperatures and retains them for an extra long time to obtain a defined disinfection performance. Continuous use of this function increases the hygiene status. This additional option is ideal for cleaning e.g. chopping boards and baby bottles.



Perfect for a mixed load. You can wash very soiled pots and pans in the lower basket together with normally soiled utensils in the upper basket. The spray pressure in the lower basket is intensified, the rinsing temperature is increased slightly.



An increased temperature during the final rinse and an extended drying phase ensure that even plastic parts dry better. There is a slight increase in the energy consumption.

## Operating the appliance

### AquaSensor \*

\* depending on the features of your dishwasher

The Aqua sensor is an optical measuring device (light barrier) which measures the turbidity of the rinsing water.

The AquaSensor is used according to the programme. If the AquaSensor is active, “clean” rinsing water can be transferred to the next rinse bath and water consumption can be reduced by litres. If the turbidity is greater, the water is drained and is replaced with fresh water. In the automatic programmes the temperature and running time can also be adjusted to the degree of soiling.

### Switching on the appliance

1. Turn tap fully on.

2. Switch on ON/OFF switch **1**. The displays for the last programme and last additional function selected flash. These settings will be retained unless another **2** programme key is pressed. The expected programme duration flashes on the digital display **9**.
3. Press the START button **6**.  
Programme sequence starts.

### Remaining running time display

When the programme is selected, the remaining programme time is indicated in the display window **9**.

The running time is determined during the programme by the water temperature, the quantity of dishes as well as the degree of soiling and may vary (depending on the selected programme).

### Time preselection \*

\* depending on the configuration of your specific dishwasher

You can delay the start of the programme in hourly steps by up to 24 hours.

#### Here's how to set up the delay:

1. Switch on ON/OFF switch **1**.
2. Press the timer programming button **4** + repeatedly until **9 h 01** appears in the display window.
3. Keep pressing the timer programming button **4** - or + until the desired time is displayed.
4. Press START button P. The delay timer has been activated.
5. To clear the specified delay, press the button **4** - or + repeatedly until **9 h 00** appears in the display window.

Until the programme has started, you can change your selection in any way you like.

### Programme end

The programme has finished when the value **0:00** appears in the display window **9**.

### Auto Power Off (Automatic switch off after end of programme)

To save power you can set the dishwasher to switch off automatically from 1 minute to 120 minutes after the end of its programme. You can choose a setting from **P:00** to **P:02**.

- P:00** Appliance does not switch off automatically.
- P:01** Appliance switches off after 1 minute.
- P:02** The appliance switches off after 120 minutes.

**Here's how to change the setting:**

1. Switch on ON/OFF switch  1.
2. Hold down the programme button  A and then repeatedly press the START button  6 until **d:0...** appears in the display window.
3. Release both buttons. The LED of the  A button flashes and the digital display  9 lights up to show the value **d:0.....**
4. Press the programme button  A repeatedly until the value **P:0...** appears in the display window  9.
5. Press the programme button  C  
Each time the button is pressed, the set value increases by one level; when it reaches the value **P:02** the display jumps back to **P:00**
6. Press START button  6. The set value is saved.

**Switching off the appliance**

**Shortly after the end of the programme:**

1. Switch off ON/OFF switch  1.
2. Turn off water supply (does not apply to appliances with Aqua-Stop).
3. Remove the utensils when they have cooled down.

**Note:** When the programme ends, leave the appliance to cool down a while before opening it. This will prevent steam from escaping and causing long-term damage to your built-in furniture.

**Interrupting the programme**

**Caution!**

Expansion (overpressure) may cause the appliance door to jump open and/or water to escape! If the door was opened on an appliance which has a hot water connection or is heated, always leave the door ajar for several minutes and then close it.

1. Switch off ON/OFF switch  1. The LEDs go out. The programme is saved.



2. Switch on the ON/OFF switch  again to continue the programme.

### Terminating the programme (Reset)

1. Press the START button  and hold it down for about 3 seconds. The value **0:01** appears in the display window. The programme sequence lasts about minute. The value **0:00** appears in the display window .
2. Switch off ON/OFF switch .

### Changing the programme

When the START button  has been pressed, the programme cannot be changed. The only way a programme can be changed is by Cancel programme (Reset).

### ExtraDry

The final rinse uses a higher temperature which improves the drying result. The running time may increase slightly. (Be careful if you have delicate tableware)

#### Here's how to change the setting:

1. Switch on ON/OFF switch .
  2. Hold down the programme button  and then repeatedly press the START button  until **d:0...** appears in the display window .
  3. Release both buttons.
  4. By pressing the  button you can switch intensive drying on **d:01** or off **d:00**.
  5. Press START button .
- The set value is saved.

## Cleaning and maintenance

A regular inspection and maintenance of your machine will help to prevent faults. This saves time and prevents problems.

### Overall status of the dishwasher

\*The interior of your dishwasher is predominantly self-cleaning. In order to remove deposits, your dishwasher automatically changes the running of the programme (such as by increasing the cleaning temperature) at certain intervals. This will lead to higher consumption values when running this programme.

\*Depending on the features of your dishwasher

**If you should find deposits in the interior of the dishwasher in spite of this, remove these deposits as follows:**

1. Fill the detergent dispenser 1j with detergent.
2. Select the programme with the highest temperature.
3. Start the programme without dishes.

### **Warning**

- Health hazard due to detergents containing chlorine!
- Always use chlorine-free detergents.

### **Notes**

- Only clean the appliance with special detergents/appliance cleaners which are suitable for use with dishwashers.
- Regularly wipe the door seals using a damp cloth and a little washing-up liquid. This will keep the door seal clean and hygienic.
- Leave the door open slightly if the appliance will not be used for a while. This will prevent an unpleasant odour from developing.
- Never clean the dishwasher using a steam cleaner. The manufacturer is not liable for any consequential damage.
- Wipe the front of the dishwasher and the control panel regularly using a damp cloth and a little washing-up liquid.
- Do not use sponges with a rough surface or abrasive detergents. These could scratch the surface.
- For dishwashers with a stainless steel front, avoid using sponge cloths, or rinse these thoroughly several times before using them for the first time. This will prevent corrosion.

## **Machine Care**

Machine Care used in combination with commercially available machine cleaning detergent is a suitable programme for cleaning your dishwasher. Deposits such as grease and limescale can cause your dishwasher to malfunction. In order to avoid such faults and to reduce the development of odours, we recommend cleaning the dishwasher at regular intervals.

\*As soon as the Machine Care display lights up in the control panel, or you are advised to do so on the front display, run the Machine cleaning programme Machine Care without loading any tableware. After you have run the Machine Care the display in the control panel will go out.

If your dishwasher does not have a reminder function, follow the instructions for use on the machine cleaning detergents.

## Notes

- Remove any coarse soiling in the interior using a damp cloth.
- Run the programme without dishes, and in combination with a machine cleaning detergent.
- Use a special machine cleaning detergent, and not dishwasher detergent.
- Observe the safety instructions and the instructions for use on the machine cleaning detergent packaging.
- \*After three rinse cycles, the display in the control panel will go out automatically, even if you have not run the Machine cleaning cycle programme. depending on the features of your dishwasher

### Rinse aid

Fill the rinse aid as soon as the refill indicator  lights up in the control panel.

### Filters

The filters  keep large foreign objects in the rinsing water away from the pump. these foreign objects may occasionally block the filters.

The filter system consists of

- a coarse filter
- a flat fine filter
- a microfilter

1. After each washing cycle check the filters for residue.

2. Unscrew filter cylinder as illustrated and take out filter system.

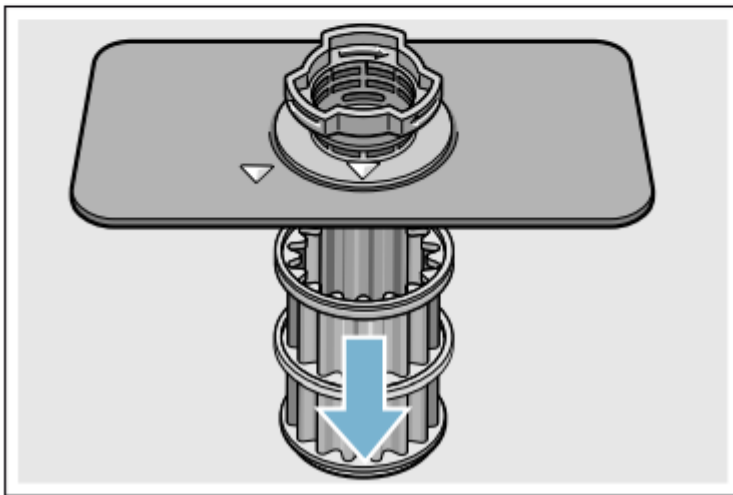
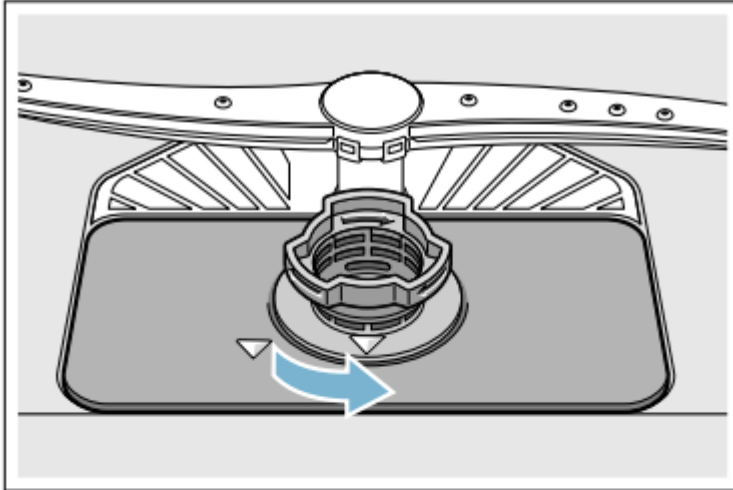

3. Remove any residue and clean filters under running water.

4. Re-install filter system in reverse sequence and ensure that the arrow marks are opposite each other after closing the filter system.

### Spray arms

Limescale and contaminants in the rinsing water may block nozzles and bearings on the spray arms **22** and **24**

1. Check outlet nozzles on the spray arms for blockages.
2. Unscrew the upper spray arm **22** (1) and remove downwards (2).

3. Remove the lower spray arm **24** upwards.

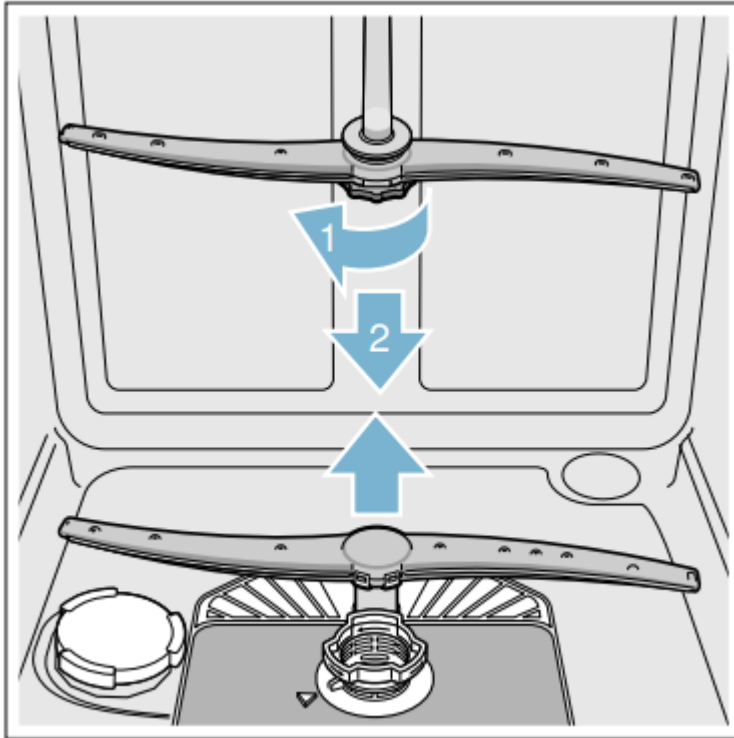

4. Clean spray arms under running water.  
5. Re-engage or screw on spray arms.

## Fault, what to do?

Experience has shown that you can rectify most faults which occur in daily operation yourself. This ensures that the appliance is quickly available to you again. In the following overview you can find possible causes of malfunctions and helpful information for rectifying them.

**Note:** If the appliance stops during dishwashing or does not start for no obvious reason, first run the Abort programme function (Reset) → Operating the appliance" on page 25.

### Warning

- Improper repairs or use of non-original spare parts may cause considerable damage and put the user at considerable risk!
- Always have repairs carried out by technicians. If a component has to be replaced, always use original spare parts.

## Waste water pump

Large food remnants or foreign objects which were not captured by the filters may block the waste water pump. The rinsing water will then be above the filter.

### Warning

### Danger of cutting!

Sharp and pointed objects or glass fragments may block the waste water pump.

Always carefully remove foreign objects.

### Clean the waste water pump as follows:

1. Disconnect the dishwasher from the power supply.
2. Take out top basket **21** and bottom basket **27**.
3. Remove the filters **25**.
4. Scoop out water, use a sponge if required.
5. Prise off the pump cover (as shown) using a spoon. Grip the pump cover by the crosspiece and lift diagonally inwards (1). Remove cover completely.

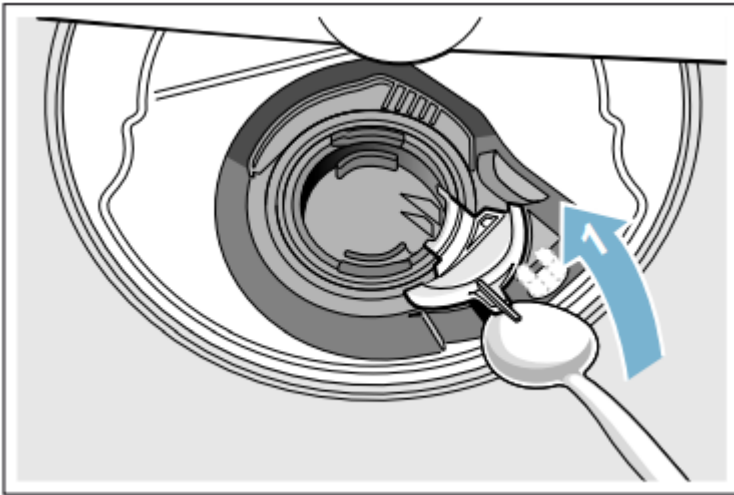

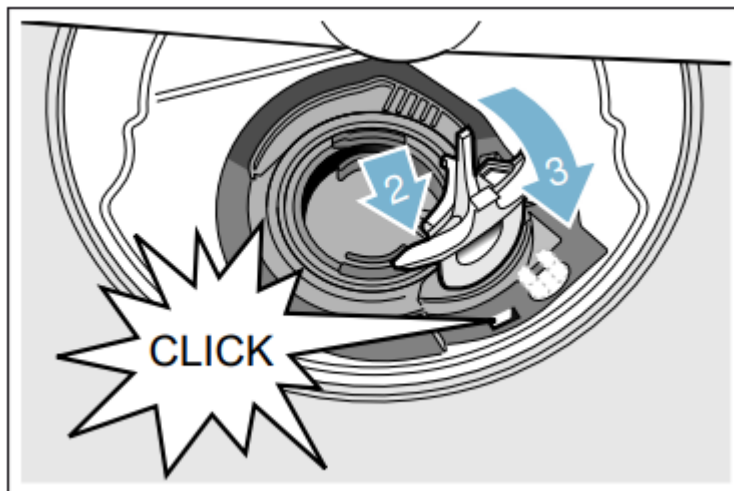

6. Check impeller wheel and remove any foreign objects.
7. Place pump cover in the original position (2) and press down until it engages (3).





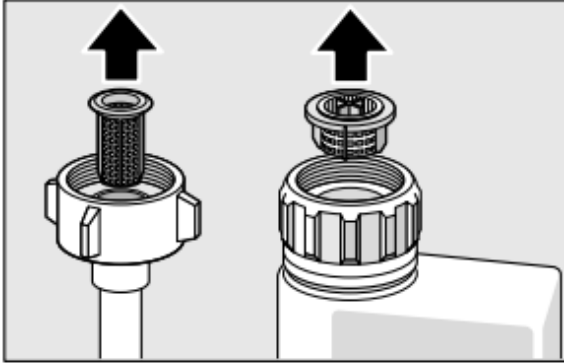

8. Install filters.
9. Re-insert baskets.

## Fault table

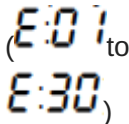
Fault	Reason	Reason
"Check water supply" display  lights up.	Supply hose kinked.	Install supply hose without kinks.
	Tap turned off.	Turn on the tap.
	Tap jammed or calcified.	Turn on the tap. Flow rate must be at least 10 l/min. when water supply is open.
	Filter in the water supply blocked.	Switch off the appliance and pull out the mains plug. Turn off the tap. Unscrew water connection.  Clean filter in the supply hose. Screw water connection on again. Check for leaks. Reconnect power supply. Switch on the appliance.
Fault code  is lit.	Intake opening (on right inside of appliance) covered by utensils.	Arrange utensils so that the intake opening is not obstructed.
Fault code  is lit.	Heating element soiled.	Clean appliance with dishwasher cleaning agent.

Fault code <b>E: 14</b> is lit.	Water protection active.	Turn off tap. Call customer service and quote the fault code.
Fault code <b>E: 15</b> is lit.		
Fault code <b>E: 16</b> is lit.	Constant water supply.	
Fault code <b>E: 22</b> is lit.	Filters <b>25</b> are soiled or blocked.	Clean filters. → "Filters" on page 29
Fault code <b>E: 24</b> is lit.	Wastewater hose kinked or blocked.	Install hose without kinks, remove any residue.
	Siphon connection still sealed.	Check connection to siphon and open if required.
	Cover on the wastewater pump loose.	Lock cover correctly. → "Waste water pump" on page 31
Fault code <b>E: 25</b> is lit	Wastewater pump blocked or cover on the wastewater pump is not locked in position.	Lock cover correctly. → "Waste water pump" on page 31
Fault code <b>E: 27</b> is lit.	Mains voltage too low.	No appliance fault, have the mains voltage and electrical installation checked.
A different fault code is indicated on	A technical fault has	Switch off the appliance with the ON/OFF switch (.After a short time, restart the appliance. If the problem recurs, turn off the tap

<p>the digital display.    (E:01 to E:30)</p>	<p>probably occurred.</p>	<p>and pull out the mains plug. Call customer service and mention the fault code.</p>
<p><b>L</b> or <b>H</b>  appears on the digital display   . *</p>	<p>Not a fault!</p>	<p>See TurboSpeed 20 min. in the chapter "Overview of programmes". *</p>
<p>Refill indicator for rinse aid    is lit.</p>	<p>No rinse aid.</p>	<p>Refill rinse aid.</p>
<p>Refill indicator for rinse aid    is not lit.</p>	<p>Refill indicator switched off.</p>	<p>Activation/Deactivation. → Page 13</p>
	<p>There is still enough special rinse aid available.</p>	<p>Check the filling level, refill indicator.</p>
<p>Water is left in the appliance at the end of the programme.</p>	<p>Filter system or area under the filters  is blocked.</p>	<p>Clean filters and area underneath (see "Waste water pump").</p>
	<p>Programme not finished yet</p>	<p>Wait until programme ends or reset (see "Terminating the programme").</p>
<p>Utensils not dry.</p>	<p>Not enough rinse aid in the dispenser, or none at all.</p>	<p>Refill rinse aid.</p>
	<p>Programme without drying was selected.</p>	<p>Select programme with drying.</p>

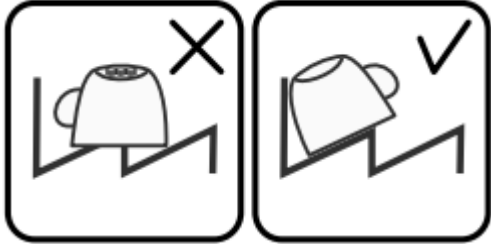
	<p>Water collecting in depressions on the utensils and cutlery</p>	<p>Arrange utensils in a sloping position, arrange affected utensils as sloping as possible.</p> 
	<p>The combined detergent used has a poor drying performance.</p>	<p>Use different combination detergent with better drying performance. Use of rinse aid also improves the drying performance.</p>
	<p>Intensive drying to increase drying not activated.</p>	<p>Activate intensive drying. → "Operating the appliance" on page 25</p>
	<p>Utensils were removed too early or drying process had not ended yet.</p>	<p>Wait until the programme ends, or wait until 30 minutes after the end of the programme before removing the utensils.</p>
	<p>The eco rinse aid used has a poor drying performance.</p>	<p>Use a name-brand rinse aid. Eco products are much less effective.</p>
<p>Plastic utensils not dry.</p>	<p>Special properties of plastic.</p>	<p>Plastic has a lower heat storage capacity and therefore dries less well.</p>
<p>Cutlery not dry.</p>	<p>Cutlery not arranged properly in the cutlery basket.</p>	<p>Cutlery not arranged properly in the cutlery basket.</p>

	Cutlery not arranged properly in the cutlery drawer.	Arrange cutlery properly and separate if possible.
Appliance interior wet after rinse cycle.	No appliance fault.	On account of the "Condensation drying" principle, water droplets are physically induced and required in the container. The humidity in the air condenses on the inner walls of the dishwasher, drains and is pumped out.
Food remnants on the utensils.	Utensils placed too closely together, utensils basket overfilled	Arrange utensils with adequate clearance between them ensuring that the spray jets can reach the surface of the utensils. Prevent contact points.
	Spray arm rotation obstructed.	Arrange utensils so that the spray arm can rotate without obstruction.
	Spray arm nozzles are blocked.	Clean the spray arm nozzles. → "Cleaning and maintenance" on page 27
	Filters <span style="border: 1px solid black; padding: 0 2px;">25</span> dirty	Clean filters. → "Cleaning and maintenance" on page 27
	Filters <span style="border: 1px solid black; padding: 0 2px;">25</span> inserted incorrectly and/or not engaged.	Insert and engage filters correctly.
	Rinse programme too weak.	Select a more intensive rinse programme.
	Utensils precleaned too	Do not prerinse utensils. Remove only large food remnants.

	<p>intensely; sensors therefore decide on weak programme sequence. Stubborn soiling cannot be completely removed.</p>	
	<p>Tall narrow receptacles in corner areas are not rinsed adequately.</p>	<p>Do not place tall narrow receptacles too obliquely and do not place in the corner area.</p>
	<p>Top basket <b>21</b> on right and left not set to same height.</p>	<p>Set top basket to same height using side levers.</p>
Detergent residue	<p>Detergent dispenser cover <b>29</b> blocked by utensils and therefore does not open fully.</p>	<p>Utensils must not be placed above the tablet collecting tray <b>23</b>:. These may block the lid of the detergent dispenser and prevent it from opening fully. → "Upper basket" on page 15 Do not place utensils or fragrance dispenser in the tablet collecting tray</p>
	<p>Detergent dispenser cover <b>29</b> blocked by the tablet.</p>	<p>Tablet must be inserted flat and not upright.</p>
	<p>Tablets used in the quick or short</p>	<p>Dissolving time of tablets too long for a quick or short programme. Use a detergent powder or select a more intensive programme.</p>

	<p>programme. Dissolving time of the detergent is not reached in the selected short programme.</p>	
	<p>Washing effect and dissolving performance are reduced after a prolonged storage time or detergent is very lumpy.</p>	<p>Change detergent.</p>
<p>Water stains on plastic parts.</p>	<p>Droplet formation on plastic surface is physically unavoidable. After drying, water stains are visible.</p>	<p>Use a more intensive programme (more water changes). Arrange utensils in a sloping position. Use rinse aid.</p>
<p>Washable or water-soluble coatings in the container or on the door.</p>	<p>Detergent substances are deposited. These coatings cannot usually be removed with chemicals (appliance cleaner, ...).</p>	<p>Change detergent brand. Clean appliance mechanically.</p>
	<p>Only for glasses: Initial glass corrosion – can only</p>	<p>See “Glass and utensil damage” → Page 14.</p>

	apparently be wiped off	
White, stubborn coatings; limescale on the utensils, container or door.	Detergent substances are deposited. These coatings cannot usually be removed with chemicals (appliance cleaner, ...).	Change detergent brand. Clean appliance mechanically.
	Underdosing of detergent	Increase detergent dosage or change detergent.
	Rinse programme selected too weak.	Select a more intensive rinse programme.
Tea or lipstick residue on the utensils	Rinsing temperature too low.	Select programme with higher rinsing temperature.
	Too little or unsuitable detergent.	Use suitable detergent at correct dosage.
	Utensils precleaned too intensely; sensors therefore decide on weak programme sequence. Stubborn soiling cannot	Do not prerinse utensils. Remove only large food remnants.

	be completely removed	
Coloured (blue, yellow, brown), difficult to remove to non-removable coatings in the appliance or on stainless steel utensils.	Film formation consisting of ingredients from vegetables (e.g. cabbage, celery, potatoes, noodles, ...) or the tap water (e.g. manganese).	Can be partly removed with machine cleaner or by mechanical cleaning. Coatings are harmless.
	Film formation caused by metallic components on silver or aluminium utensils.	Can be partly removed with machine cleaner or by mechanical cleaning.
Discolouration of the plastic parts inside the appliance.	Plastic parts inside the appliance may become discoloured during the service life of the dishwasher.	Discolouration is normal and will not impair the function of the dishwasher
Plastic parts discoloured.	Rinsing temperature too low.	Select programme with higher rinsing temperature.
	Utensils precleaned too intensely; sensors	Do not prerinse utensils. Remove only large food remnants.

	<p>therefore decide on weak programme sequence. Stubborn soiling cannot be completely removed.</p>	
<p>Removable streaks on glasses, glasses with metallic appearance and cutlery.</p>	<p>Too much rinse aid.</p>	<p>Set rinse aid amount to lower setting setting.</p>
	<p>No rinse aid added or setting too low.</p>	<p>Add rinse aid and check dosage (recommended Level 4–5).</p>
	<p>Detergent residue in the final rinse. Detergent dispenser cover blocked by utensils (cover does not open fully)</p>	<p>Detergent dispenser cover must not be obstructed by utensils. Do not place utensils or fragrance dispenser in the tablet collecting tray</p>
	<p>Utensils precleaned too intensely; sensors therefore decide on weak programme sequence. Stubborn soiling cannot be completely removed.</p>	<p>Do not prerinse utensils. Remove only large food remnants.</p>

Initial or existing, irreversible clouding of glass.	Glasses not dishwasher-proof, only suitable for dishwasher.	Use dishwasher-proof glasses. Avoid long steam phase (standing time after rinse cycle ends). Use rinse cycle at lower temperature. Use detergent with glass protection component.
Rust spots on the cutlery.	Cutlery is not sufficiently rust-resistant. Knife blades are frequently more severely affected.	Use rust-resistant cutlery.
	Cutlery will also rust if rusting parts are rinsed at the same time (pan handles, damaged utensil baskets, etc.).	Do not wash rusting parts.
Appliance cannot be switched on or operated.	Malfunction.	Disconnect appliance from the power supply; pull out the mains plug or switch off the fuse. Wait at least 5 seconds, then connect the appliance to the power supply.
Appliance does not start.	The mains fuse has tripped.	Check mains fuse
	Power cord not inserted.	Ensure that the power cord is plugged all the way into the back of the appliance and into the socket. Check that the socket functions.
	The appliance door has not been shut properly.	Close the door

Programme starts automatically.	You did not wait until programme ended.	Perform reset. (See “Terminating the programme”)
The door is difficult to open.	Child-proof lock is activated.	Deactivate child-proof lock.(See instructions for use at the back)
Door cannot be closed.	Door lock has been activated.	Close door with increased force
	Door cannot be closed due to installation.	Check appliance installation: Door or attached parts must close without obstruction.
Cover on the detergent dispenser cannot be closed.	Detergent dispenser or cover guide blocked by sticky detergent residue	Remove detergent residue.
Detergent residue in the detergent dispenser or in the tablet collecting tray.	Spray arms blocked by utensils, therefore detergent is not rinsed out	Ensure that the spray arms can rotate freely
	The detergent dispenser was damp when filled.	damp when filled. Pour detergent into the dry detergent dispenser only.
Appliance stops during the programme or	Door not closed properly.	Close the door.

programme is interrupted.	Do not place utensils or fragrance dispenser in the tablet collecting tray. Top basket presses against the door and prevents door from being closed securely	Check whether rear panel is being pressed in, e.g. by socket or by hose holder which has not been removed.
	Power and/or water supply interrupted.	Restore power and/or water supply
Filling valves making striking noises.	Depends on domestic installation, as appliance is not defective. No effect on appliance function.	No remedial action possible.
Knocking or rattling noise	Spray arm strikes the utensils, utensils not positioned correctly	Position utensils so that the spray arms do not strike the utensils. If there is a low load, the water jets strike the washing tank directly. Load the appliance with
	If there is a low load, the water jets strike the washing tank directly.	Load the appliance with more utensils or distribute the utensils more evenly in the dishwasher.

	Light utensils move during the rinse cycle.	Arrange light utensils securely.
Unusual foam formation.	Hand washing-up liquid in the rinse aid dispenser.	Immediately refill rinse aid dispenser with rinse aid.
	Rinse aid spilled.	Remove rinse aid with a cloth.

**Warning**

This content is compiled from multiple sources and is provided for reference purposes only. It may not be complete or fully applicable to all situations. If you are unable to resolve your issue, please contact the product manufacturer or an authorized service provider for official support.

