

## What's New in Your Dishwasher

### Energy

Congratulations on purchasing your water and energy efficient dishwasher! This dishwasher cleans by spraying the dishes with water and pauses to allow the detergent to soak into and release the soils on the dishes. The cycles are longer due to the soak and pauses for exceptional cleaning. Your dishwasher contains an optical water sensor. The optical water sensor is used to determine the optimum water and energy consumption for great cleaning performance. Efficient dishwashers run longer to save water and energy, just as driving a car slower saves on gas. The first cycle using the sensor will run longer to calibrate the optical sensor.



### Performance

#### Rinse Aid

Using rinse aid will optimize your drying and wash performance. This dishwasher is specifically designed to be used with rinse aid for improved drying performance and controlling buildup of hard water deposits. The use of rinse aid greatly improves drying by allowing water to drain from the dishes after the final rinse. Rinse aid also keeps water from forming droplets that can dry as spots or streaks.

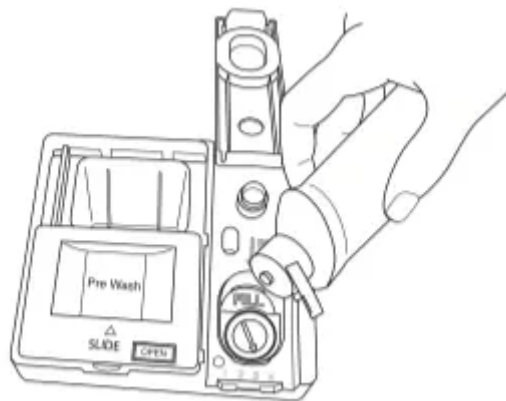

### Detergent

The United States and Canada have passed restrictions limiting the amount of phosphorus (phosphates) in household dishwasher detergents to reduce the impact of detergents on our environment. Major manufacturers have reformulated their dishwasher detergent. With these recent changes it is recommended to use tablets and packs for convenience and improved performance.

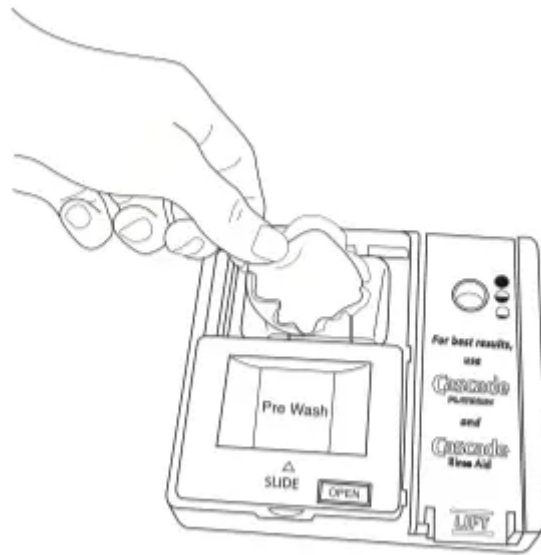

### Filtration System

Your dishwasher has the latest technology in dishwasher filtration. The Clean Water Wash system continuously removes food particles from the wash water for excellent performance. Plus, there is no need to ever remove and clean the filter.

## Parts and Features

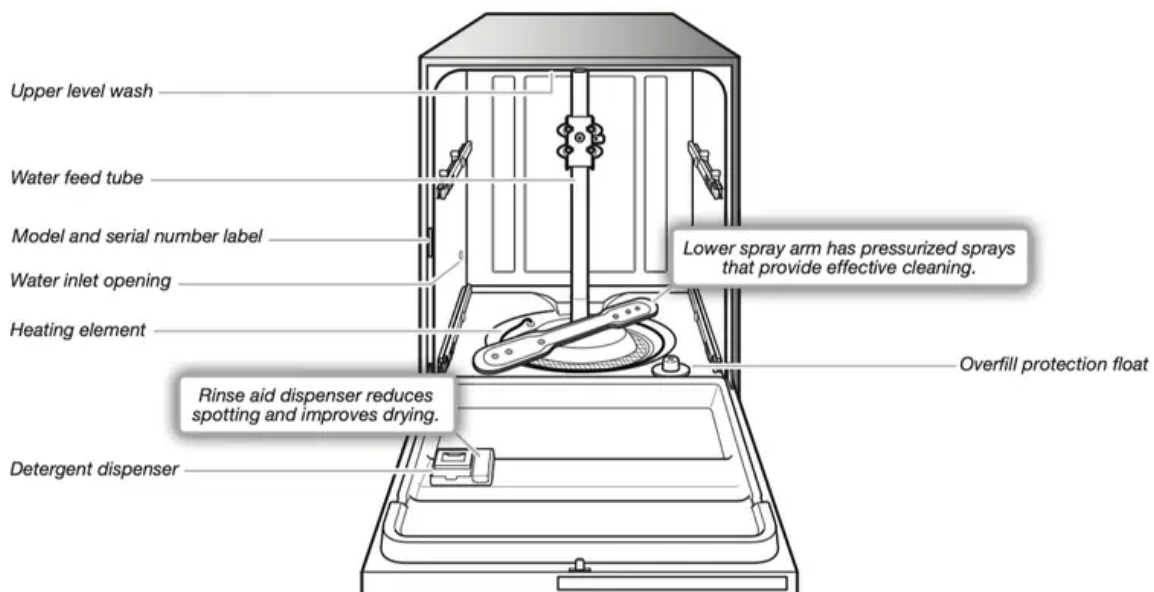

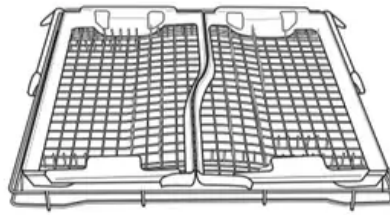

**CULINARY RACK (On some models)**

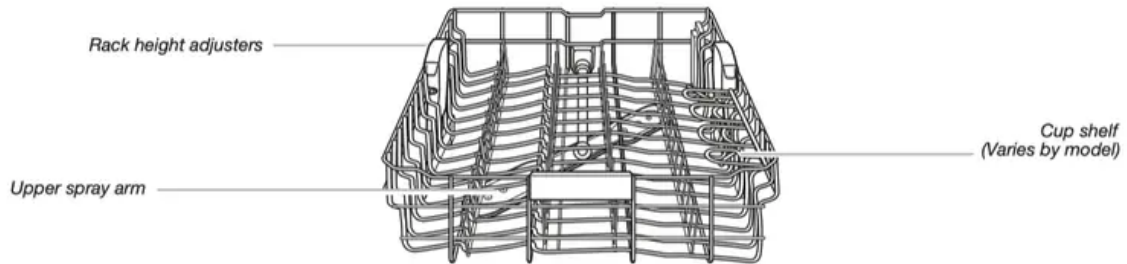

**TOP RACK (Varies by model)**

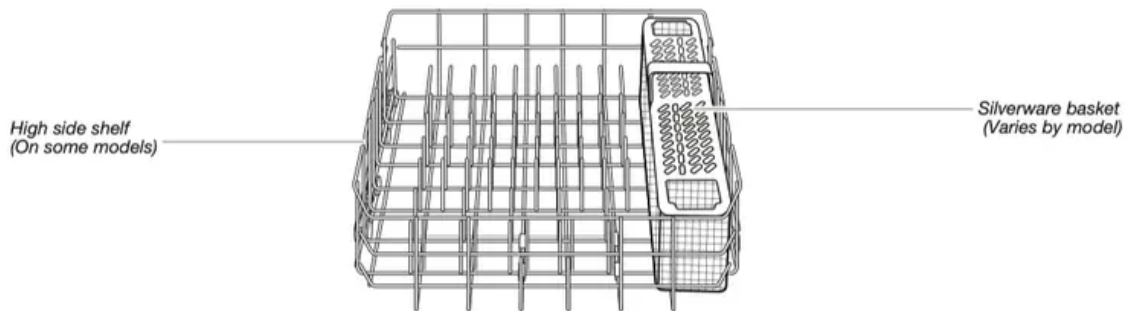

**BOTTOM RACK**

## Start-Up/Quick Reference

### Drying - Rinse Aid is essential

You must use a drying agent such as a rinse aid for good drying performance. Rinse aid along with the Long Power Dry (Long Heated Dry on some models) option will provide best drying and avoid excessive moisture in the dish washer interior.

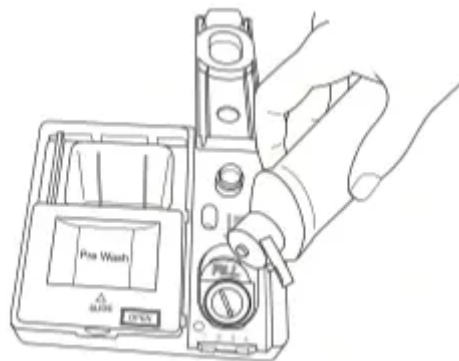

### Long Power Dry (Long Heated Dry on some models)

For best drying use the Long Power Dry (Long Heated Dry on some models)

## Quick Wash - When you need fast results

Efficient dishwashers run longer to save water and energy, just as driving a car slower saves on gas. When you need fast results, the Quick Wash will clean your dishes using slightly more water and energy. Select a heated drying option to include automatic drying.

### ■ Quick

## Press START every time you add a dish

**IMPORTANT:** If the door is opened after starting the dishwasher (even during the Delay hours), the START button must be pressed each time.

Push door firmly closed within 4 seconds of pressing START. If door is not closed within 4 seconds, the START button light will flash, an audible tone will be heard and cycle will not start.

START



## Proper Detergent Dosing

We recommend quality tablets and packs for convenience and improved performance.

When using other forms of detergent, it is possible to use too much. This can lead to etching of your dishes. See “Add Detergent” in the Dishwasher Use section, to determine the amount of detergent needed based on soil level and water hardness.

## Quick Steps

1. Remove bulk food and load dishwasher.

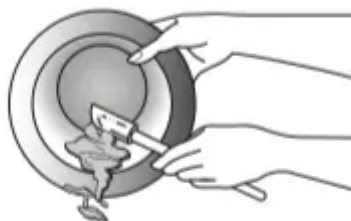

Scrape off excess food into garbage or food disposer.

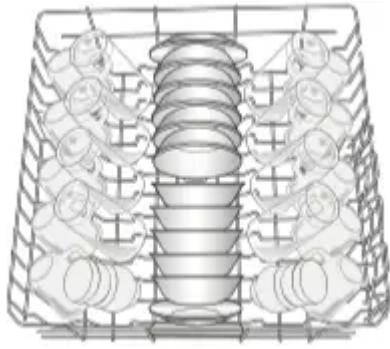

Load dishes so that water spray will reach every surface.

2. Add detergent and rinse aid.

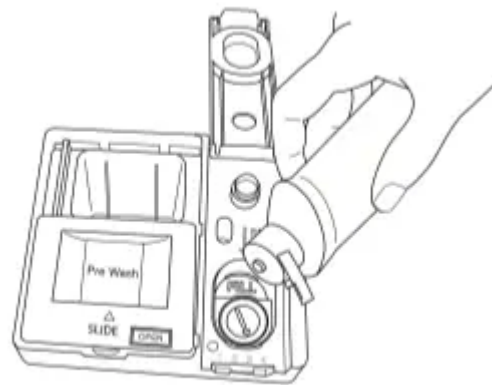

3. Select a cycle and options.

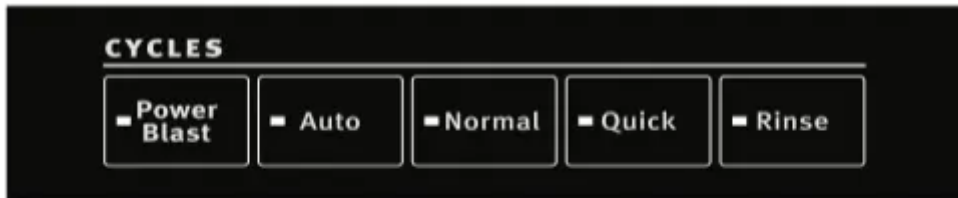

4. Start dishwasher.

To START a cycle, press the START keypad and close the door within 4 seconds. If the door is not closed within 4 seconds, the START light will flash, an audible tone will sound, and the cycle will not start.

START



## Dishwasher Use

### STEP 1 Prepare and Load the Dishwasher

**IMPORTANT:** Remove leftover food, bones, toothpicks, and other hard items from the dishes. Remove labels from containers before washing.

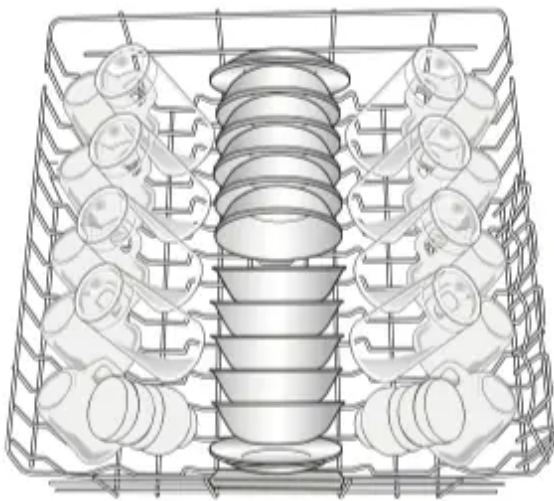

*Upper rack*

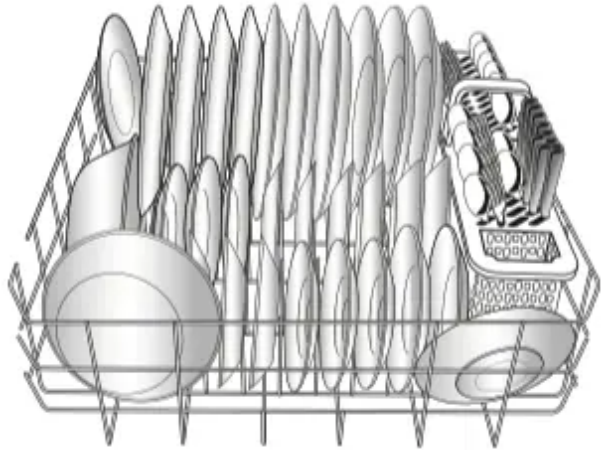

*Lower rack*

*Rack may vary by model.*

- Check that nothing blocks the upper or lower spray arm. Items in rack can block the spray arms.

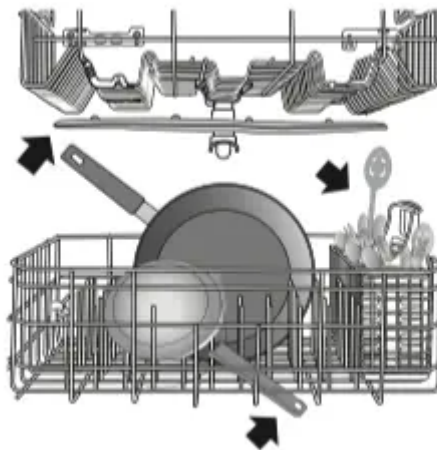

- Check that when the dishwasher door is closed, no items are blocking the detergent dispenser.
- Tough soiled items should be loaded with soiled surfaces facing down and inward to the spray. This will improve cleaning and drying results.
- Avoid overlapping items like bowls or plates that may trap food.
- Place plastics, small plates, and glasses in the upper rack.

Wash only plastic items marked “dishwasher safe.”

- To avoid thumping/clattering noises during operation, load dishes so they do not touch one another. Make sure lightweight load items are secured in the racks.
- When loading silverware, always place sharp items pointing down. If you remove the slotted covers from the silverware basket, mix items in each section of the basket with some pointing up and some down to avoid nesting. Spray cannot reach nested items.
- Use slots in the covers and suggested loading patterns to keep your silverware separated for optimum wash.

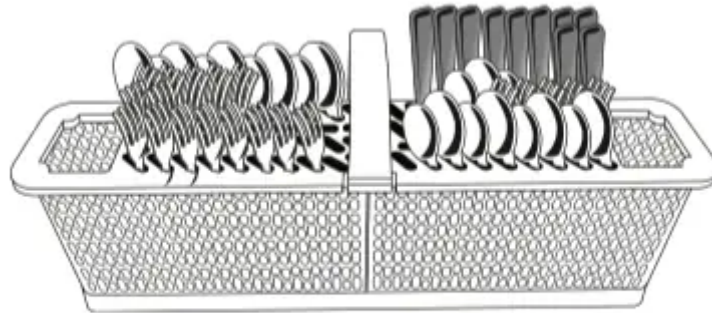

*Varies by model*

## STEP 2 Add Detergent

### Premeasured Detergents

High-quality premeasured tablets and packs are recommended for improved performance.

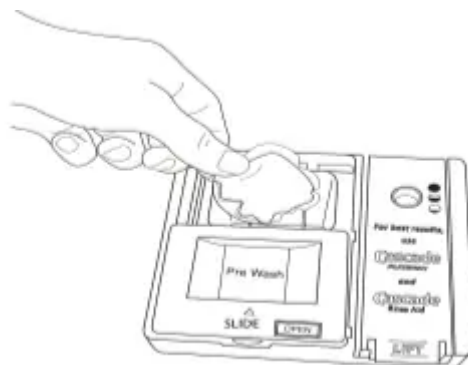

Quality tablets and packs have been proven better than powder, liquid or gel detergents at reducing filming on dishes. Using tablets and packs over time will start to reduce or eliminate white film. They are suitable for all hardness and soil levels. Also, by using a rinse aid, you can minimize repeat buildup of white film (not all packs and tablets contain rinse aid). Always place premeasured detergents in main compartment and close the lid.

**NOTE:** Follow instructions on the package when using other dishwasher detergent types or use the chart below for standard powdered detergents.

- Use automatic dishwasher detergent only. Add detergent just before starting a cycle.
- Fresh automatic dishwasher detergent results in better cleaning. Store tightly closed detergent container in a cool dry place.

### To close lid

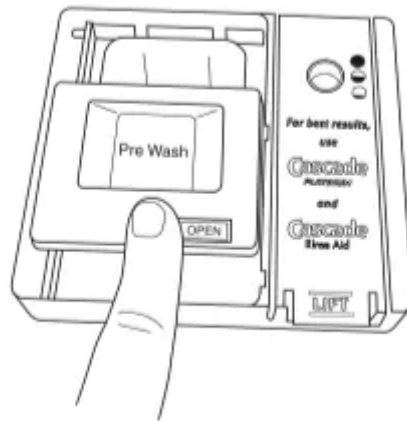

Place selected detergent in the dispenser. Place finger, as shown, and slide lid closed. Press firmly until it clicks.

### To open lid

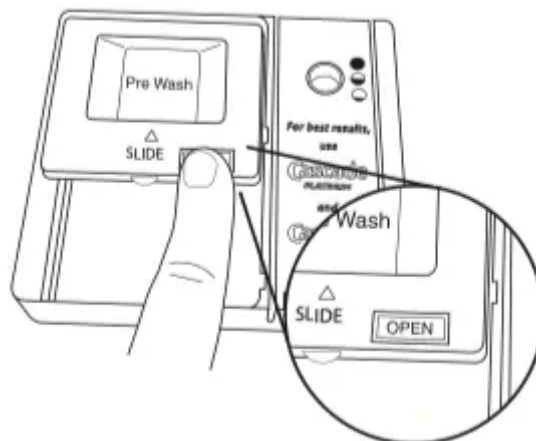

Push OPEN, as shown, and the lid will slide open.

### Powders and Gels

Water Hardness	Soil Level	Prewash Compartment*	Main Wash Compartment
<b>Soft (0-4 grains per U.S. gallon)</b>	Light	None	“Soft” fill line
	Normal	None	“Soft” fill line
	Heavy	Full	“Soft” fill line
<b>Medium (5-9 grains per U.S. gallon)</b>	Light	None	“Soft” fill line
	Normal	Full	Full**
	Heavy	Full	Full**
<b>Hard (10-14 grains per U.S. gallon)</b>	Light	Full	Full**
	Normal	Full	Full**
	Heavy	Full	Full**

\*The prewash compartment is on top of the sliding door of the dispenser.

\*\*A full main wash compartment contains 2 Tbsp (30 ml).

**IMPORTANT:** Extremely hard water mineral deposits (15 grains per U.S. gallon or more) can cause damage to your dishwasher and make it difficult to achieve good results. A water softener is recommended to avoid damage and achieve good results.

**NOTE:** Follow instructions on the package when using other dishwasher detergent types.

### STEP 3 Rinse Aid

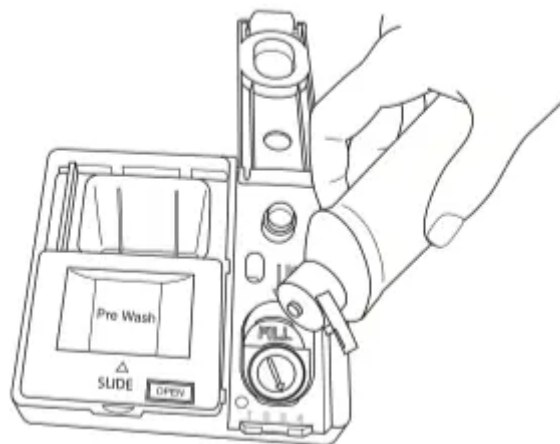

**IMPORTANT:** Your dishwasher is designed to use rinse aid. The use of rinse aids greatly improves drying by allowing water to drain from the dishes after the final rinse. Rinse aid also keeps water from forming droplets that can dry as spots or streaks.

## Filling the dispenser

The dispenser holds 5 oz (150 mL) of rinse aid. Under most conditions this will last 1 to 3 months.



**NOTE:** Indicator reads correct fill level when door is completely opened.

1. To add rinse aid, open the rinse dispenser lid by gently pushing in the center of the lid with your thumb and pulling up on the edge.
2. Pour rinse aid into the opening until the dispenser is full. Do not overfill.
3. Clean up any spilled rinse aid. Spilled rinse aid can create excessive suds.
4. Close the dispenser by pushing down gently on the lid.

## Rinse Aid Setting

Your rinse aid dispenser is adjustable. For most water conditions, the factory setting will give good results. If you have hard water and notice calcium buildup on your dishware, you may want to try a higher setting. If you notice foam in your dishwasher, use a lower setting.

### To adjust the setting:

Turn the arrow adjuster to a higher number to increase the amount of rinse aid. If you change the setting only change it one number at a time and run a few cycles before changing it again. Too much rinse aid can reduce cleaning performance and too little may leave spots or rings.



## STEP 4 Select a Cycle

Efficient dishwashers run longer to save water and energy, just as driving a car slower saves on gas. Typical cycle time is approximately 2 1/2 hours but can take less or more time to complete

depending on selections. Press START keypad to select the Auto cycle or select another cycle appropriate for your load (see Cycle Guide).

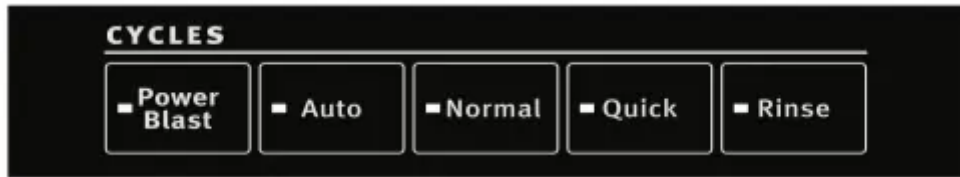

### Select Options (Options varies by model)

See the "Cycle and Option Descriptions" chart in the following section.

You can customize the cycles by selecting the options desired and pressing the START keypad.



### STEP 5 Start a Cycle

- If needed, run hot water at the sink nearest your dishwasher until the water is hot. Turn off water.
- For best dish washing results, water should be 120°F (49°C) as it enters the dishwasher.
- Select the wash cycle and options desired. To run the Auto cycle, press the START keypad twice. Within 4 seconds of pressing START keypad you must firmly push the door closed. If the door is not closed within 4 seconds, the START light will flash, an audible tone will be heard, and the cycle will not start.

### START



- You can add an item at the beginning of the cycle. Open the door slowly and add the item. Press the START keypad and close the door firmly within 4 seconds. If the door has been open more than 4 seconds the light will flash, a tone will sound and the dishwasher will not resume unless you press START keypad again.

**IMPORTANT:** If the door has been opened for more than a few seconds after the cycle has started (even during the Delay time), The START button must be pressed again or the cycle will not resume.

## STEP 6 Follow the progress of your dishwasher

A light on the front right corner of the door panel will glow blue for washing/rinsing, red for drying, and white for complete.

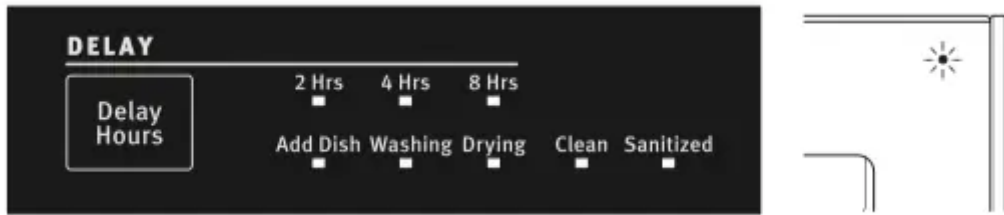

The display will indicate cycle progress such as Add Dish, Washing, Drying, Clean and Sanitized. The cycle has completed when the Clean light is lit. Refer to the Controls and Cycle Status section for operation of the Sanitized indicator.

## Dishwasher Features

### Silverware Basket (Varies by model)

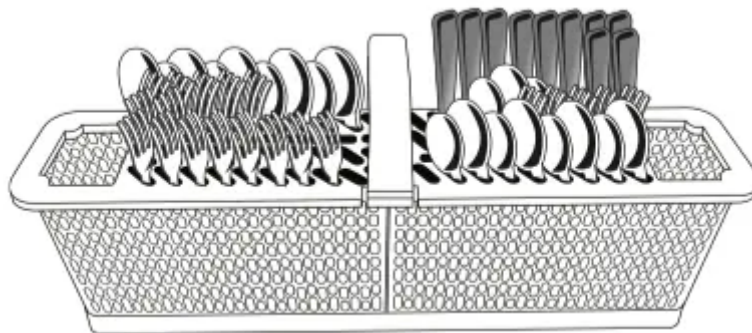

#### Silverware basket lids:

Use silverware basket lids to provide optimal spacing and best cleaning performance.

**NOTE:** If your silverware does not fit into the designated slots, push tabs inward on either end and lift lid off of the silverware baskets. Mix silverware types to keep them separated. Load knives down, forks up, and alternate spoons for best cleaning results.

### Cup Shelves (On some models)

Fold down the extra shelf on the left-hand or right-hand side of the top rack to hold additional cups, stemware, or long items such as utensils and spatulas. For best results on cups, stagger the spacing so that the cups on the shelf are not directly above the cups below.



### Adjustable Upper Rack

You can raise or lower the top rack to fit tall items in either the upper or lower rack. Adjusters are located on each side of the top rack.

**To Raise :** Press both rack adjuster thumb levers and lift the rack until it is in the up position and level.

**To Lower:** Press both rack adjuster thumb levers and slide the rack to its down position and level.

**NOTE:** The top rack must be level.

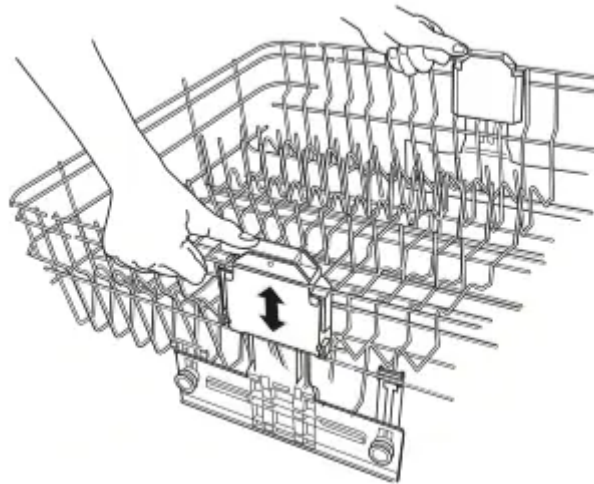

### Removable Top Rack LAVA RAIL (On some models)

The removable top rack allows you to wash larger items, such as pots, roasters, and cookie sheets, in the bottom rack.

**IMPORTANT:** Remove dishes prior to removing the top rack from the dishwasher.

**To remove the rack:**

To gain access to the removable tabs on the tracks/rails, pull the upper rack forward about halfway out of the tub.

On one side, press the tab on the track in and pull up the front end of the rack out of the track. Then repeat this step on the other side to completely remove the front end of the rack. Then remove the rack by pulling the back end out using a forward and upward motion.

**To replace the rack:**

Pull the tracks forward about halfway out of the tub. Along the sides of the racks are round attachment tabs. Align the rack's back end attachment tabs with the cutout in the track. Push down into place. Pull the tracks completely out, and align the rack's front-end attachment tabs with the cutout in the track. Push down into place. You will hear a snap when the front end of the rack is secured into place on each side.

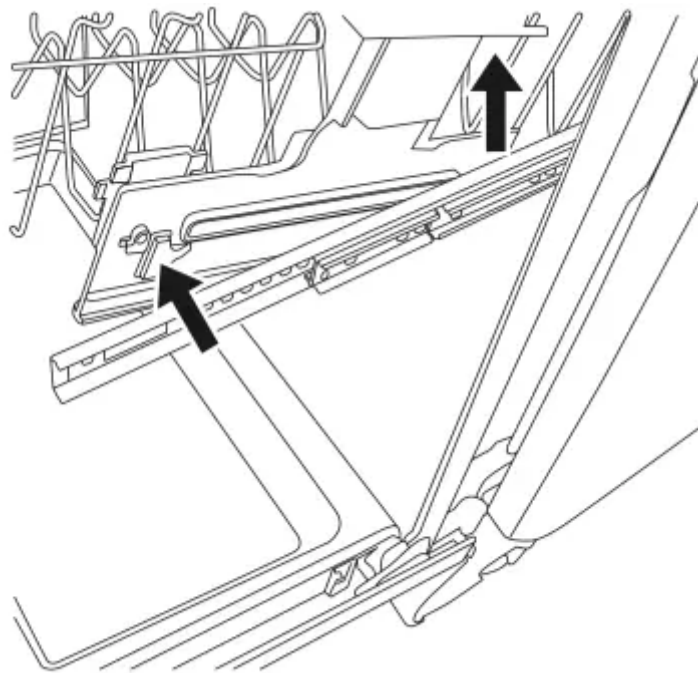

**Removable Top Rack CC-RAIL (On some models)**

The removable top rack allows you to wash larger items such as pots, roasters, and cookie sheets in the bottom rack.

**IMPORTANT:** Remove dishes prior to removing the top rack from the dishwasher.

**To remove the rack**

1. To gain access to the track stops, pull the upper rack forward about halfway out of the tub.
2. To open, flip the track stop toward the outside of the tub.
3. After opening both track stops, pull top rack out of the rails.
4. Close track stops and slide the tracks back into the dishwasher.



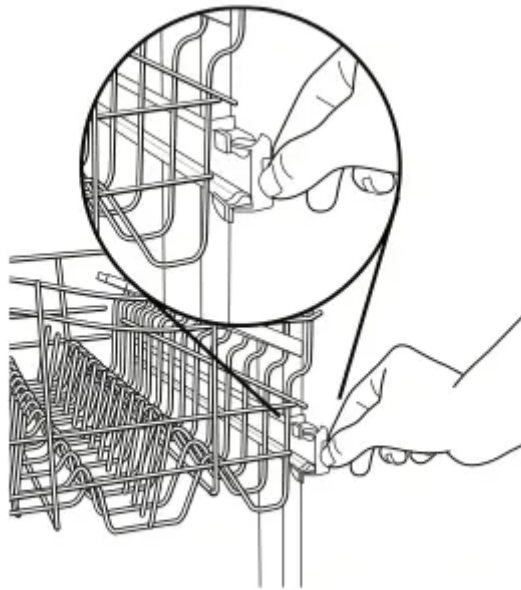

### To replace the rack

1. Gently pull tracks forward in dishwasher until they stop. Open track stops.
2. Place the back wheels on each side of the rack into the track slot and roll them back into the tracks, but do not push the rack all the way into the tub.
3. Insert front rack wheels on each side of the rack into the track slots.
4. Slide rack into the dishwasher. The stops will automatically close when rack enters dishwasher.

### Easy To Remove Third Level Rack (On some models)

If additional space is needed in the upper rack, the third level rack can easily be removed.

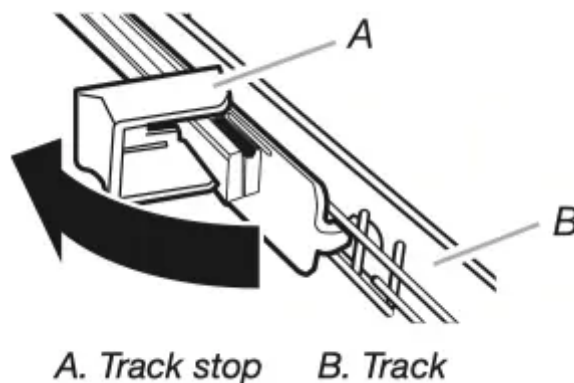

### Culinary Tool Rack (Third level rack, on some models)

The culinary tool rack is designed with 2 movable baskets to hold extra silverware, knives and cooking utensils. Install the baskets in this up position when you have extra silverware and flatware to wash.

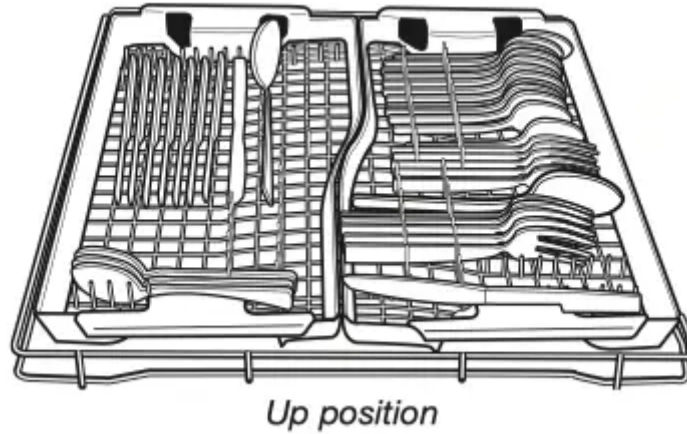

Install the baskets in this down position when you have extra silverware, knives, or utensils requiring more room to wash.

**IMPORTANT:** When you are using the culinary tool baskets in the down position, the top rack must also be in the lowest position.

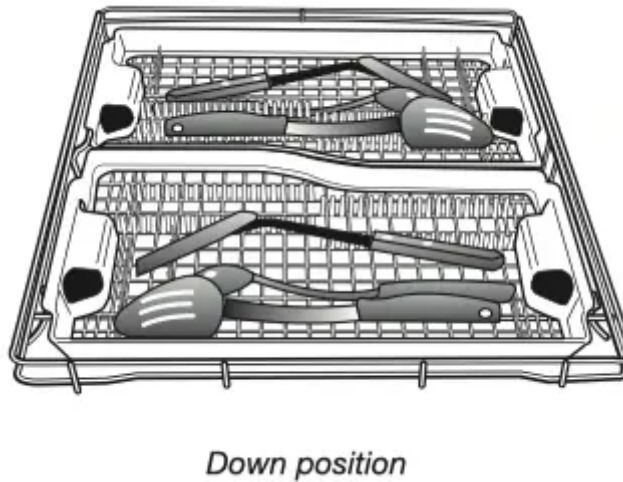

Remove the front basket when you are using the cup shelves or have other tall items in the top rack for more room.

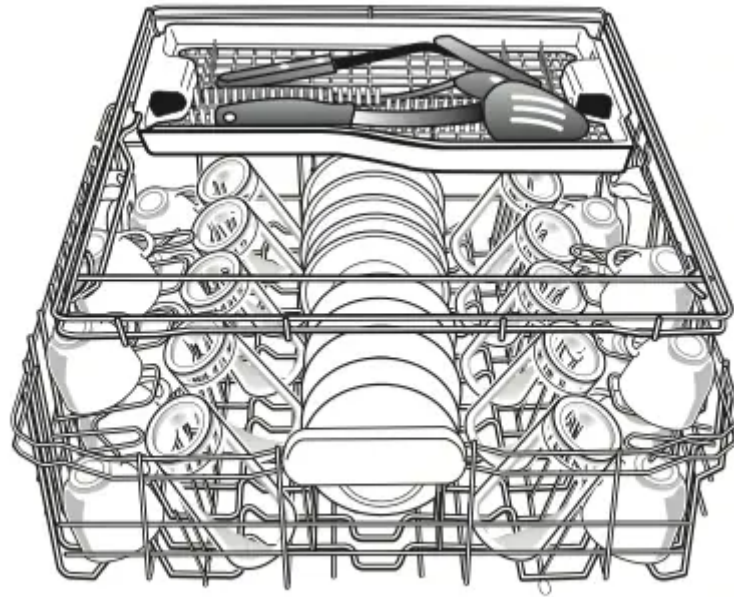

### **Removable Culinary Tool Rack (Third level rack, on some models)**

The removable Culinary Tool Rack (Third level rack) allows you to wash larger items in the upper rack, or remove both the Culinary Tool Rack and top rack to wash larger times in the lower rack. See “Removable Top Rack” section.

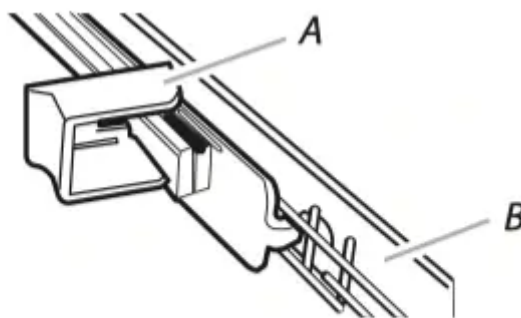

*A. Track stop    B. Track*

### **To Remove the Culinary Tool Rack**

1. To access track stops, pull the rack forward until it stops and clicks into place.
2. To open track stops, flip the track stop (A) to the outside of the track.
3. After opening both track stops, slide front wheels up and out of the slot (B) in track. Continue to pull rack forward in track and slide the back wheels up and out of the track.
4. Close track stops.
5. Slide rack tracks back into dishwasher.

## Stemware Guides (On some models)

Stemware guides are designed into the cup shelf. Use them to hold stemware more securely.

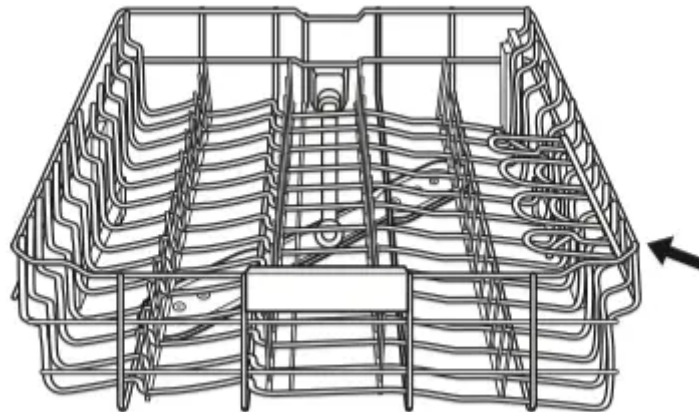

## Cycle and Option Descriptions



Estimated cycle times may increase or decrease depending on water temperature, soil conditions, dish load size, and options selected. You can customize your cycle by selecting options.

See option selections. If you change your mind, press the option again to turn off the option, or select a different option. You can change an option anytime before the selected option begins. At each stage of the wash cycle, you may hear noises that you are not used to hearing in your previous dishwasher. Each cycle will provide a series of pauses and water sprays throughout the wash cycle. This is normal and will provide optimal cleaning performance.

## CYCLE SELECTIONS

**IMPORTANT:** The sensor in your dishwasher monitors the soil level. Cycle time and/or water usage can vary as the sensor adjusts the cycle for the best wash performance. If the incoming water is less than the recommended temperature or food soils are heavy, the cycle will automatically compensate by adding time, heat, and water as needed.

This information covers several different models. Your dishwasher may not have all of the cycles and options described.

CYCLES	ESTIMATED WASH TIME* W/O OPTIONS (HH:MM)	WATER USAGE GALLONS (LITERS)
<p><b>■ Power Blast</b> Targets toughest food soils. Use for hard-to-clean heavily soiled pots, pans, casseroles, and tableware.</p>	3:30 to 3:45	9.0 (34.2)
<p><b>■ Auto</b> This cycle senses the load size, soil amount, and toughness of soil, to adjust the cycle for improved cleaning, using only the amount of water and energy needed. The Auto cycle is automatically selected if you first press the Start button. Includes a heated drying option.*</p>	2:45 to 3:15	4.5 to 6.9 (17.0 to 26.0)
<p><b>■ Normal</b> This cycle is recommended for daily, regular or typical use to completely wash and dry a full load of normally soiled dishes. This dishwasher's government energy certifications were based on the Normal cycle with only the Short Power Dry (Short Heated Dry on some models) option selected.**</p>	2:30 to 3:30	3.0 to 7.4 (11.2 to 27.9)
<p><b>■ Quick</b> For fast results, the Quick cycle will clean dishes using slightly more water and energy. For improved drying, select a power or heated drying option.</p> <p><b>NOTE:</b> Some detergents are not recommended for short wash cycles, please refer to your detergent packaging for more information. Includes a heated drying option.</p>	1:00	5:5 (21.0)
<p><b>■ Rinse</b> Use for rinsing dishes, glasses, and silverware that will not be washed right away. Do not use</p>	0:07	1.3 (5.0)

detergent. During cycle, the rinse action will repeatedly pause for several seconds.		
--	--	--

\*The government energy certifications are not based on this cycle. See the Normal cycle description for the government energy certification cycle. Using the Auto cycle may increase your energy usage.

\*\*No other washing and drying temperature options were selected, and the dishwasher was not subjected to truncated testing. Rinse aid was not used, and there was no detergent used in the prewash.



## OPTION SELECTIONS



OPTIONS	CAN BE SELECTED WITH	WHAT IT DOES ADDED TIME TO CYCLE (HH:MM)	ADDED WATER GALLONS (LITERS)
<p><b>■ High Temp</b></p> <p>Raises main wash temperature to improve cleaning for loads containing tough, baked-on food.</p>	<p>Auto PowerBlast® Normal</p>	<p>Raises main wash temperature to a minimum of 129°F (53.9°C). Press and hold the button for 3 seconds to turn on/off sound.</p> <p>0:00 to 1:00</p>	<p>0-3.3 (0-12.5)</p>
<p><b>■ Sanitize</b></p> <p>Sanitizes dishes and glassware in accordance with NSF International NSF/ANSI Standard 184 for Residential Dishwashers. Certified residential dishwashers are not intended for licensed food establishments. Only sanitizing cycles have been designed to meet the requirements of the NSF/ANSI 184 performance standard for soil removal and for sanitization efficacy. There is no intention, either directly or indirectly, that all cycles on a NSF/ANSI 184 certified dishwasher meet the NSF/ANSI 184 performance standard for soil removal and for sanitization efficacy. The Sani Rinse indicator glows at the end of the cycle if the Sani Rinse option was successfully completed. If your load did not properly sanitize, the indicator will flash at the end of the cycle. This can happen if the cycle is interrupted, or if the water does not reach the required temperature. The light goes off when you open and close the door or press CANCEL.</p>	<p>Auto PowerBlast® Normal</p>	<p>Raises the main wash temperate to 145°F (62.8°C) and the final rinse temperature to (156°F (69°C).</p> <p>0:15 to 1:30</p>	<p>0-3.7 (0-14.0)</p>



<div data-bbox="172 185 427 450" style="background-color: #e0e0e0; padding: 10px; border: 1px solid #ccc;"> <p style="text-align: center;"><b>Short Heated Dry</b> (On Some Models)</p> </div> <p>Dries dishes with heat.</p> <p>This option, with the use of rinse aid, will provide optimum drying performance. Plastic items are less likely to deform when loaded in the top rack. Turn off all heated dry options for air dry.</p>	<p>Auto PowerBlast® Normal Quick</p>	<p>Uses a heating element to speed drying times. Short Heated Dry option is on when any cycle is selected except for Quick and Rinse.</p> <p>0:11 to 0:46</p>	<p>NA</p>
<div data-bbox="172 792 427 1010" style="background-color: #e0e0e0; padding: 10px; border: 1px solid #ccc;"> <p style="text-align: center;"><b>Long Heated Dry</b> (On Some Models)</p> </div> <p>Uses heat and additional time to dry dishes. For the very best drying performance, use rinse aid and the Long Heated Dry option.</p> <p>Turn off all heated dry options for air dry.</p>	<p>Auto PowerBlast® Normal Quick</p>	<p>Lengthens the time that Heated Dry is active.</p> <p>0:43 to 1:20</p>	<p>NA</p>
<div data-bbox="172 1267 427 1552" style="background-color: #e0e0e0; padding: 10px; border: 1px solid #ccc;"> <p style="text-align: center;"><b>Short Power Dry</b> (On Some Models)</p> </div> <p>Dries dishes with heat and a fan. This option, with the use of rinse aid, will provide optimum drying performance. Plastic items are less likely to deform when loaded in the top rack. Turn off all Fan Dry options for air dry.</p>	<p>Auto PowerBlast® Normal Quick</p>	<p>Uses a heating element and fan to speed drying times. Short Power Dry option is on when any cycle is selected except for Quick and Rinse</p> <p>0:11 to 0:46</p>	<p>NA</p>
	<p>Auto PowerBlast® Normal Quick</p>	<p>Lengthens the time that Long Power Dry is active.</p>	<p>NA</p>

<p><b>Long Power Dry</b> (On Some Models)</p> <p>Uses heat and a fan for additional time to dry dishes. For the very best drying performance, use rinse aid and the Long Power Dry option. Turn off all Fan Dry options for air dry.</p>		0:43 to 1:20	
<p><b>Delay Hours</b></p> <p>Runs dishwasher at a later time or during off-peak electrical hours. Select a wash cycle and options. Press DELAY to cycle through the delay time options. Press START. Close door firmly.</p> <p><b>NOTE:</b> Any time the door is opened (such as, to add a dish), the START keypad must be touched again to resume the delay countdown.</p>	Available with any cycle	Delays start of a cycle by 8 hours.	

## CONTROLS AND CYCLE STATUS

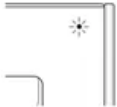
CONTROL	PURPOSE	COMMENTS
<p>START</p> 	Press to START a wash cycle.	If the door is opened during a cycle or the power is interrupted, the START button light flashes. Cycle will not resume until START is pressed and the door is closed. Push door firmly closed within 4 seconds of pressing START.
<p>CANCEL</p>  <p>Hold 3 Sec</p>	Press to cancel wash cycle	Press and hold CANCEL for 3 seconds. Close the door firmly. The dishwasher starts a 2-minute drain (if needed). Let dishwasher drain completely.
<p>DELAY</p>  	The display allows you to follow the progress of the dishwasher cycle.	Your dishwasher has indicators that glow for Add Dish, Washing, Drying, Sanitized and Clean. The exterior status light on the front of the door panel will glow blue when washing, red while it is drying, and white when the cycle is complete.

## Canceling A Cycle

1. Open the door slightly to stop the cycle. Wait for the spraying action to stop before completely opening the door.
2. Press CANCEL. The Cancel indicator will glow.

3. Close the door and the dishwasher starts a drain cycle (if water remains in bottom of dishwasher). Let the dishwasher drain completely. The Cancel indicator turns off after 2 minutes.

## **Changing A Cycle After Dishwasher Is Started**

You can interrupt a cycle and restart your dishwasher from the beginning using the following procedure.

1. Open the door slightly to stop the cycle. Wait for the spraying action to stop, then open the door completely.
2. Check that detergent dispenser cover is still closed.
  - a. If cover is open cancel the cycle and start a new cycle
  - b. If cover is closed continue to next step
3. Press CANCEL twice to reset the control.
4. Select new cycles and options.
5. Press START.

## **Adding A Dish With Add A Dish Indicator**

1. If Add a Dish indicator is lit, proceed to Step 2. If indicator is not lit an added dish might not get cleaned.
2. Open the door slightly to stop the cycle. Wait for the spraying action to stop, and then open the door completely.
3. Add the dish.
4. Press START keypad and close the door within 4 seconds to resume the cycle.

# **Dishwasher Care**

## **Cleaning the Exterior**

Clean the exterior of the dishwasher with only a soft, damp cloth, and mild detergent. If your dishwasher has a stainless steel exterior, it may have a coating that is resistant to fingerprints. Avoid using abrasive cleaning products on the exterior of the dishwasher.

## **Cleaning and Maintaining the Interior**

Many detergents may leave white spots or a white residue on dishware and on the interior of the dishwasher. Over time this residue can become unsightly and could affect dishwasher performance. Use of a dishwasher cleaning product such as affresh® † Dishwasher Cleaner can

help to remove the residue. Monthly use of affresh® † Dishwasher Cleaner is recommended to help maintain the dishwasher.

**To Use:**

1. If cleaning without dishes, place one tablet in the detergent dispenser. Do not add detergent (If significant buildup is noticeable, a second tablet can be placed in the bottom of the dishwasher.)
2. If cleaning with dishes, place one tablet in the bottom of the dishwasher. Place detergent in the dispenser.
3. Run a Normal wash cycle.

Another method to remove white residue is to use a vinegar rinse. However, vinegar is an acid and using it too often could damage your dishwasher.

Place (do not pour), 2 cups (500 mL) white vinegar in a glass or dishwasher-safe two-cup capacity container on the bottom rack. Run the dishwasher through a complete washing cycle using an air-dry or an energy-saving dry option. Do not use detergent. Vinegar will mix with the wash water.

**NOTE:** Maytag recommends the use of high-quality, premeasured detergent tablets or packs, and the use of rinse aid for dishwasher cleaning and daily care.

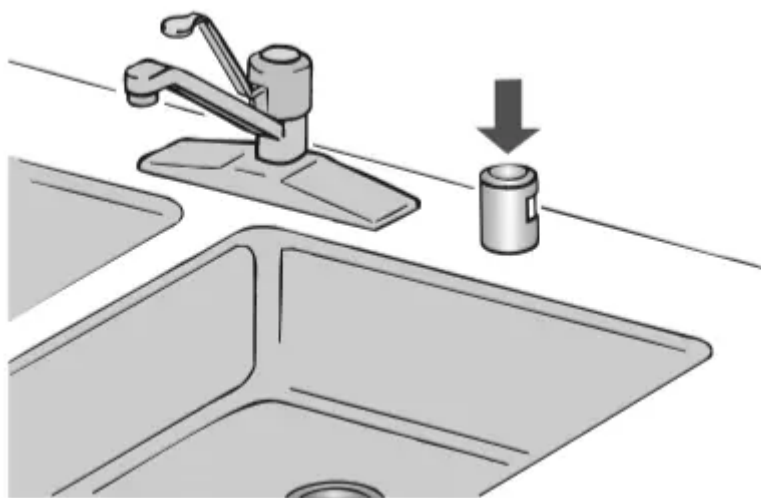

If you have a drain air gap, check and clean it if the dishwasher isn't draining well.

**To Reduce Risk of Property Damage During Vacation or Extended Time Without Use**

- When you will not be using the dishwasher during the summer months, turn off the water and power supply to the dishwasher.
- Make sure the water supply lines are protected against freezing conditions. Ice formations in the supply lines can increase water pressure and cause damage to your dishwasher or home.
- Damage from freezing is not covered by the warranty.



- When storing your dishwasher in the winter, avoid water damage by having your dishwasher winterized by authorized service personnel.

## **Troubleshooting**

First try the solutions suggested here. If you need further assistance or more recommendations that may help you avoid a service call, refer to the warranty page in this manual or visit [maytag/product\\_help](http://maytag/product_help). In Canada, visit [maytag/product\\_help](http://maytag/product_help). Contact us by mail with any questions or concerns at the address below:

PROBLEM	SOLUTION
<p><b>DISHWASHER DOES NOT RUN</b></p>	<p><b>NOTE:</b> It is normal for the dishwasher to repeatedly pause several times during a cycle. If the START light is blinking, press the START keypad and close the door within 4 seconds. Be sure the door is closed and latched.</p> <ul style="list-style-type: none"> <li>■ Check that there is not an interference with large casserole dishes and the wash system at the back of the dishwasher.</li> <li>■ Check to see if any items are protruding through the bottom or back of the rack. Also check to see if tall items are hitting the upper rack or spray arm. Adjust loading as necessary to ensure door is closed and latched.</li> </ul> <p>Press the START or CANCEL keypads or open and close the door before selecting your cycle/option. Controls must be awakened after a period of inactivity.</p> <p>Be sure you have selected a cycle. See “Cycle and Option Descriptions” section.</p> <p>Be sure there is power to the dishwasher. A circuit breaker or fuse may have tripped.</p> <p>If lights other than START blink and the unit will not run, you will need to call for service.</p>
<p><b>DETERGENT REMAINS IN THE DISPENSER OR TABLET IS ON BOTTOM OF TUB</b></p>	<p>Check for dishware such as cookie sheets, cutting boards, or large containers, etc., that may be blocking the detergent dispenser from opening properly.</p> <p>Be sure your detergent is fresh and lump free.</p> <p>Be sure the cycle has completed (the Done light is on). If it has not completed, you will need to resume the cycle by closing the door and pressing START.</p>
<p><b>CYCLE RUNS TOO LONG</b></p>	<p><b>NOTES:</b></p> <ul style="list-style-type: none"> <li>■ To use less water and reduce energy consumption, you will encounter cycles that typically run for up to 3 hours.</li> <li>■ A water heater setting of 120°F (49°C) is best the dishwasher will delay longer while heating cooler water.</li> </ul>



	<ul style="list-style-type: none"> <li>■ Some options will add time to the cycle. See the “Cycle and Option Descriptions” section. The Heat Dry option adds approximately 45 minutes.</li> </ul> <p>Try the Quick Wash cycle.</p> <p>Run the hot water at a faucet close to the dishwasher before starting the cycle.</p>
<p><b>DISHWASHER NOT DRYING</b></p>	<p><b>NOTE:</b> Plastic and items with nonstick surfaces are difficult to dry because they have a porous surface, which tends to collect water droplets. Towel drying may be necessary. Use of rinse aid along with the Power Dry or Heated Dry option is needed for proper drying. Proper loading of items can affect drying. (See specific loading instructions within this guide.) Glasses and cups with concave bottoms hold water. This water may spill onto other items when unloading.</p> <ul style="list-style-type: none"> <li>■ Unload the bottom rack first.</li> <li>■ Locate these items on the more slanted side of the rack for improved results.</li> </ul>
<p><b>WILL NOT FILL</b></p>	<p>Be sure the water to the dishwasher is turned on.</p> <p>Check that the overflow protection float is free from obstructions. See the “Parts and Features” section.</p> <p>Check for suds in the dishwasher. If foam or suds are detected, the dishwasher may not operate properly or may not fill with water. See “Blinking Lights” in the “Troubleshooting” section.</p>
<p><b>WATER REMAINS IN THE TUB/WILL NOT DRAIN</b></p>	<p>Be sure the cycle has completed (the Clean indicator is on). If it has not, you will need to resume the cycle by pressing START and closing the door within 4 seconds.</p> <p>If dishwasher is connected to a food waste disposer, be sure the knockout plug has been removed from the disposer inlet.</p> <p>Check for kinks in the drain hose.</p> <p>Check for food obstructions in the drain or disposer.</p> <p>Check your house fuse or circuit breaker.</p>



<p><b>HARD WATER (WHITE RESIDUE ON DISHWASHER INTERIOR OR GLASSWARE)</b></p>	<p><b>NOTE:</b> Extremely hard water mineral deposits can cause damage to your dishwasher and make it difficult to achieve good cleaning. A water softener is strongly recommended if your hardness is 15 grains or more. If a water softener is not installed, the following steps may help:</p> <p>Use a commercial cleaner (affresh®† dishwasher cleaner recommended) designed for dishwashers once per month.</p> <p>Always use a rinse aid.</p> <p>Always use a high-quality, fresh detergent.</p> <p>Use a detergent booster/water softener additive designed for dishwashers.</p>
<p><b>ODORS</b></p>	<p><b>NOTE:</b> If the dishwasher is not used daily, you can run a rinse cycle with the partial load until a full load is ready to run.</p> <p>Run a vinegar rinse through the dishwasher by putting 2 cups (500 mL) of white vinegar in an upright 2-cup glass measuring cup in the lower rack. Run a Normal cycle with the Heat Dry option turned off. Do not use detergent.</p> <p>The dishwasher may not be draining properly, see “Water Remains In The Tub/Will Not Drain” in the “Troubleshooting” section.</p>
<p><b>NOISY</b></p>	<p>Surging sounds can occur periodically throughout the cycle while the dishwasher is draining. Normal water valve hissing may be heard periodically.</p> <p>A normal snap sound may be heard when the detergent dispenser opens during the cycle and when the door is opened at the end of the cycle.</p> <p>Improper installation will affect noise levels.</p> <p>A thumping sound may be heard if items extend beyond the racks and interfere with the wash arms.</p> <p>Readjust the dishware and resume the cycle.</p>
<p><b>FOOD SOILS REMAIN ON DISHES</b></p>	<p>Be sure the dishwasher is loaded correctly. Improper loading can greatly decrease the washing performance. See the “Dishwasher Use” section.</p>



	<p>Select the proper cycle and option for the type of soils. The PowerBlast® cycle with the High Temp Wash option can be used for tougher loads.</p> <p>Be sure the incoming water temperature is at least 120°F (49°C).</p> <p>Use the proper amount of fresh detergent. More detergent is needed for heavier soiled loads and hard water conditions.</p> <p>Scrape food from dishes prior to loading (do not prerinse).</p>
<p><b>DISHES DIRTY/SUDS IN DISHWASHER/CYCLE NOT COMPLETE</b></p>	<p>If foam or suds are detected by the dishwasher sensing system, the dishwasher may not operate properly or may not fill with water.</p> <p>Suds can come from:</p> <ul style="list-style-type: none"> <li>■ Using the incorrect type of detergent, such as dish detergent for hand washing dishes, laundry detergent, or hand soap.</li> <li>■ Not replacing the rinse aid dispenser cap after filling (or refilling) the rinse aid.</li> <li>■ Using an excessive amount of dishwasher detergent.</li> <li>■ Inadequate rinsing off detergent from dishes washed by hand before loading them into the dishwasher.</li> </ul> <p>Call for service.</p> <p>If no water was present in the machine at any time during a heated wash cycle, the cycle will end and the Clean indicator will not come on. See “Will Not Fill” in the “Troubleshooting” section.</p>
<p><b>DID NOT SANITIZE</b></p>	<p>If the Sanitized light is blinking, the load is NOT sanitized. The cycle was interrupted in the final rinse or the temperature for your water heater is set too low. Set your water heater to 120°F (49°C).</p>
<p><b>DAMAGE TO DISHWARE</b></p>	<p>Improper loading can cause dishes to become chipped or damaged. (See specific loading instructions within this guide.)</p>
<p><b>BLINKING LIGHTS</b></p>	<p>Blinking indicators will occur when the cycle is paused or when the cycle has been interrupted by opening the door. If the START light is blinking, press the START keypad and close the door within 4 seconds.</p> <p>See START a Cycle in the “Dishwasher Use” section.</p>



If the Clean light or any other lights are blinking and the dishwasher will not run, call for service.



<p><b>CLOUDY OR SPOTTED DISHWARE (AND HARD WATER SOLUTION)</b></p>	<p>Add or adjust the amount of liquid rinse aid for better drying and to reduce spotting. See the “Detergent and Rinse Aid” section.</p> <p>Use the correct amount of detergent.</p> <p>Confirm that the cloudiness is removable by soaking the item in white vinegar for 5 minutes. Dry the item. If the cloudiness disappears, it is due to hard water. Adjust the amount of detergent and rinse aid. See “Hard Water (White Residue on Dishwasher Interior or Glassware)” in the “Troubleshooting” section. If it does not come clear, it is due to etching (see below).</p> <p>Be sure the incoming water temperature is set at 120°F (49°C).</p> <p>Try using the High Temp Wash and Sani Rinse options.</p> <p>To remove spotting run a vinegar rinse through the dishwasher using the description in the Cleaning and Maintaining the Interior section.</p>
<p><b>ETCHING (PERMANENT CLOUDINESS)</b></p>	<p>This is an erosion of the surface of the glassware and can be caused by a combination of water that is too hot, from using too much detergent with soft water, or by pre-washing. Detergent needs food soil to act upon. If etching has occurred, the glassware is permanently damaged. To avoid further etching, adjust the detergent amount to match the water hardness, stop pre-washing, and use water heating options only when incoming water temperature is below 120°F (49°C).</p>
<p><b>LEAKING WATER</b></p>	<p>Be sure dishwasher has been installed properly and is level.</p> <p>Suds can cause the dishwasher to overflow. Measure the detergent accurately and use only detergents designed for use in a dishwasher. Less detergent is needed in soft water. Try another brand of detergent if sudsing continues.</p> <p>To avoid rinse aid leaking from the dispenser, be sure the lid is securely attached and avoid overfilling.</p>
<p><b>TUB IS DISCOLORED</b></p>	<p>High iron content in the water can discolor the tub.</p> <p>Tomato-based and other foods, can discolor the tub or dishware. Large amounts of food with curry, chili powder, paprika, mustard and similar spices and tomato-based foods should be removed from the dishes before loading.</p> <p>A citrus-based cleaner can be used to clean the tub.</p>



**Warning**

This content is compiled from multiple sources and is provided for reference purposes only. It may not be complete or fully applicable to all situations. If you are unable to resolve your issue, please contact the product manufacturer or an authorized service provider for official support.

---

Document generated by [ManualsFile](#)