

# Operating Instructions

## Using the surface units

### How to Set

Push the knob in and turn in either direction to the setting you want.

At both **OFF** and **HI** the control **clicks** into position. You may hear slight **clicking** sounds during cooking, indicating the control is keeping the power level you set.

A **HOT COOKTOP** indicator light will glow when any radiant element is turned on, and will remain on until the surface is cooled to approximately 150°F.

Indicator light will:

- come on when the unit is hot to the touch.
- stay on even after the unit is turned off.
- glow until the unit is cooled to approximately 150° F.

The WM (warm) setting on the right REAR surface unit keeps already heated food warm until ready to serve.

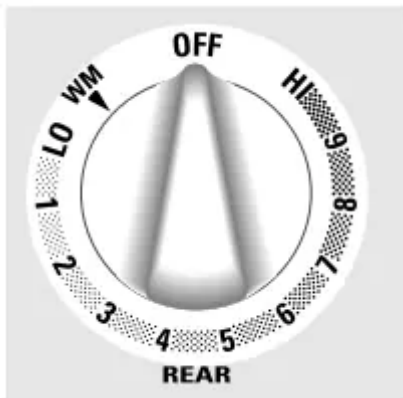

Be sure you turn the control knob to OFF when you finish cooking.



## Using the Bridge Burner

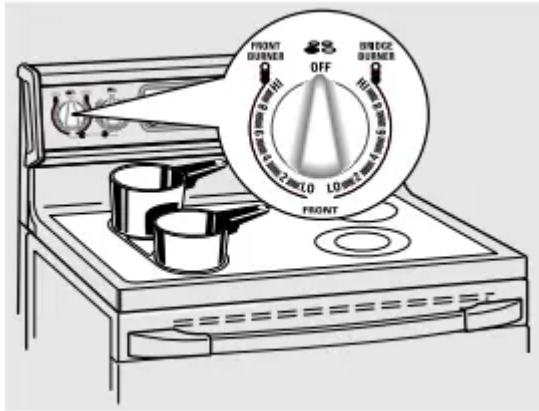

To use the bridge burner, turn the control knob to the **BRIDGE BURNER** settings.

For full bridge burner operation, turn on the rear burner.

To use only the front burner, turn the control knob to the **FRONT BURNER** settings.

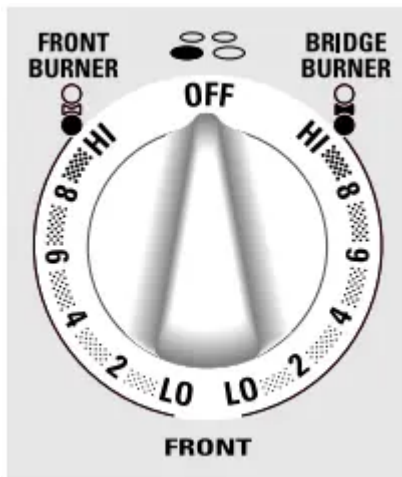

### Dual Surface Unit Control Knob

The right front surface unit has 2 cooking sizes to select from so you can match the size of the unit to the size of the cookware you are using.

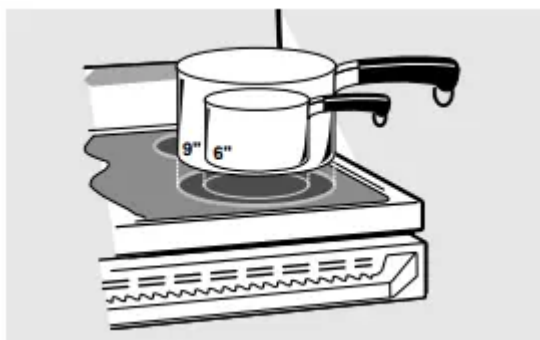

To use the small (6 inch) surface unit, turn the control knob to the **SMALL BURNER** settings.

To use the large (9 inch) surface unit, turn the control knob to the **LARGE BURNER** settings.

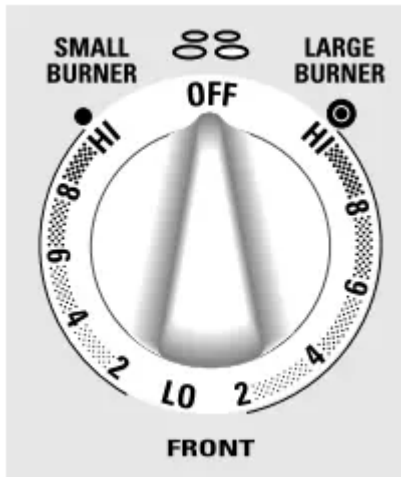

## Using the surface units

### About the radiant surface units...

The radiant cooktop features heating units beneath a smooth glass surface.

**NOTE:** A slight odor is normal when a new cooktop is used for the first time. It is caused by the heating of new parts and insulating materials and will disappear in a short time.

**NOTE:** On some models with a white glass cooktop, it is normal for the surface to appear discolored when it is hot. This is temporary and will disappear as the glass cools.

The surface unit will cycle on and off to maintain your selected control setting.

It is safe to place hot cookware on the glass surface even when the cooktop is cool.

Even after the surface units are turned off, the glass cooktop retains enough heat to continue cooking. To avoid overcooking, remove pans from the surface units when the food is cooked. Avoid placing anything on the surface unit until it has cooled completely.

*Never as a cutting board.*



*Always place the pan in the center of the surface unit you are cooking on*



*Do not slide cookware across the cooktop because it can scratch the glass-the glass is scratch resistant, not scratch proof.*

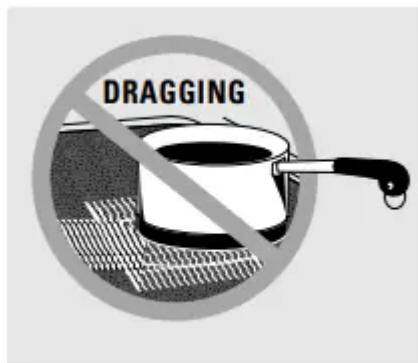

- Water stains (mineral deposits) are removable using the cleaning cream or full strength white vinegar.
- Use of window cleaner may leave an iridescent film on the cooktop. The cleaning cream will remove this discoloration.
- Don't store heavy items above the cooktop. If they drop onto the cooktop, they can cause

### **Temperature Limiter**

Every radiant surface unit has a temperature limiter.

The temperature limiter protects the glass cooktop from getting too hot.

The temperature limiter may cycle the units off for a time if:

- The pan boils dry
- The pan bottom is not flat
- The pan is off center
- There is no pan on the unit

### **Selecting types of cookware**

The following information will help you choose cookware which will give good performance on glass cooktops.

*Check pans for flat bottoms by using a straight edge.*

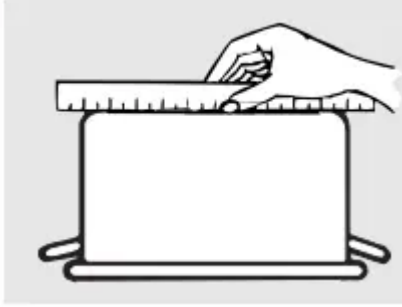

*Pans with rounded, curved, ridged or warped bottoms are not recommended.*

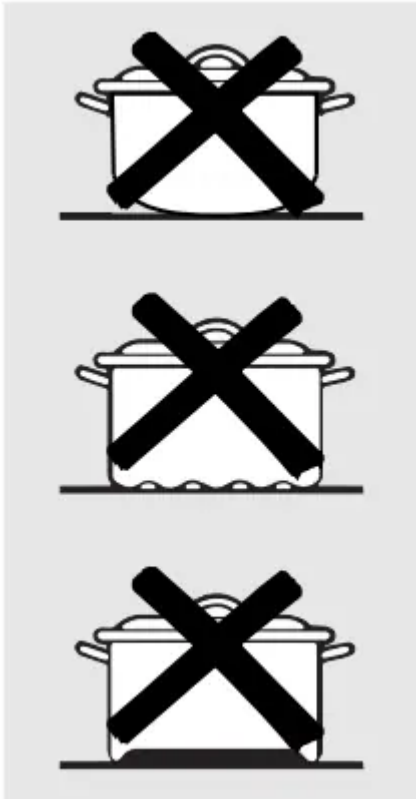

**Stainless Steel:**

recommended

**Aluminum:**

heavy weight recommended

Good conductivity. Aluminum residues sometimes appear as scratches on the cooktop, but can be removed if cleaned immediately. Because of its low melting point, thin weight aluminum should not be used.

**Copper Bottom:**

recommended



Copper may leave residues which can appear as scratches. The residues can be removed, as long as the cooktop is cleaned immediately. However, do not let these pots boil dry. Overheated metal can bond to glass cooktops. An overheated copper bottom pot will leave a residue that will permanently stain the cooktop if not removed immediately.

#### **Porcelain Enamel Covered Cast Iron:**

recommended

As long as the cookware is covered completely with porcelain enamel, this cookware is recommended. Caution is recommended for cast iron cookware that is not completely covered with smooth porcelain enamel, as it may scratch the glass ceramic cooktop.

#### **Glass-ceramic:**

usable, but not recommended

Poor performance. May scratch the surface.

#### **Stoneware:**

usable, but not recommended

Poor performance. May scratch the surface.

#### **Home Canning Tips:**

Be sure the canner is centered over the surface unit.

Make sure the canner is flat on the bottom.

Use recipes and procedures from reputable sources. These are available from manufacturers such as Ball® and Kerr® and the Department of Agriculture Extension Service.

To prevent burns from steam or heat, use caution when canning.

#### **Wok Cooking**

We recommend that you use only a flat-bottomed wok. They are available at your local retail store.

Do not use woks that have support rings.

Placing the ring over the surface unit will cause a build-up of heat that will damage the cooktop.

Do not use round bottom woks. You could be seriously burned if the wok tipped over.

*Use only flat-bottomed woks*

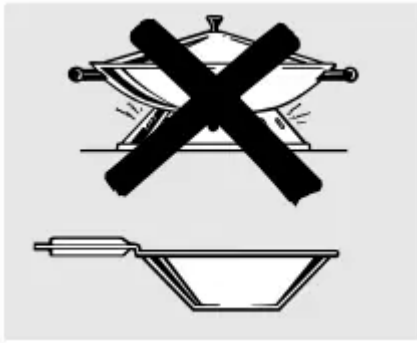

## Using the oven controls

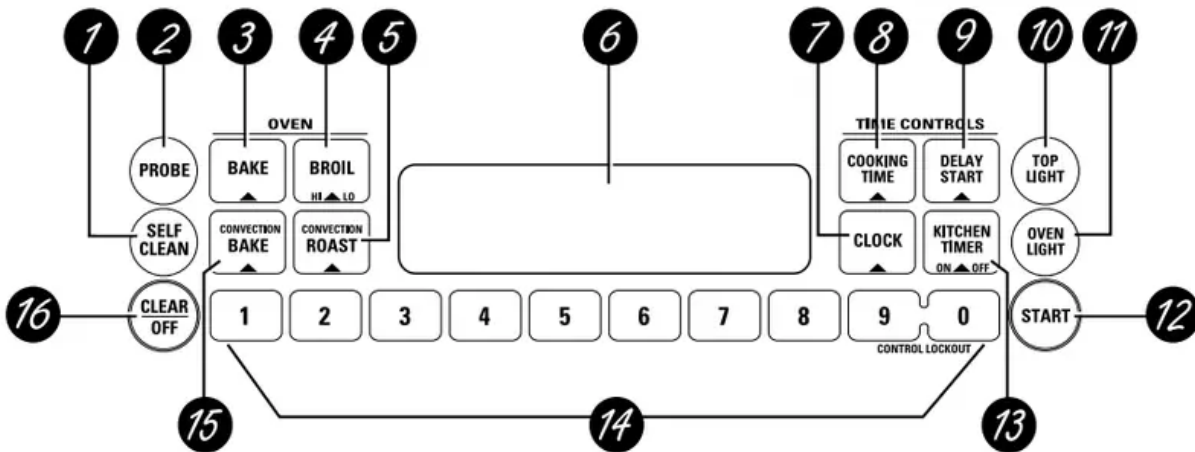

### 1. SELF CLEAN Pad

Touch this pad to select the self-cleaning function.

### 2. PROBE Pad (on some models)

Touch this pad when using the probe to cook food to the desired internal temperature.

### 3. BAKE Pad

Touch this pad to select the bake function.

### 4. BROIL HI/LO Pad

Touch this pad to select the broil function.

### 5. CONVECTION ROAST Pad

Touch this pad to select roasting with the convection function.

### 6. Display

Shows the time of day, oven temperature, whether the oven is in the bake, broil or selfcleaning mode and the times set for the timer or automatic oven operations.

If “F– and a number or letter” flash in the display and the oven control signals, this indicates a function error code.

If your oven was set for a timed oven operation and a power outage occurred, the clock and all programmed functions must be reset.

The time of day will flash in the display when there has been a power outage.

7. **CLOCK** Pad

Touch this pad before setting the clock.

8. **COOKING TIME** Pad

Touch this pad and then touch the number pads to set the amount of time you want your food to cook. The oven will shut off when the cooking time has run out.

9. **DELAY START** Pad

Use along with **COOKING TIME** or **SELF CLEAN** pads to set the oven to start and stop automatically at a time you set.

10. **TOP LIGHT** Pad

Touch this pad to turn the surface light on or off.

11. **OVEN LIGHT** Pad

Touch this pad to turn the oven light on or off.

12. **START** Pad

Must be touched to start any cooking or cleaning function.

13. **KITCHEN TIMER ON/OFF** Pad

Touch this pad to select the timer feature.

14. **Number** Pads

Use to set any function requiring numbers such as the time of day on the clock, the timer, the oven temperature, the internal food temperature, the start time and length of operation for timed baking and self-cleaning.

15. **CONVECTION BAKE** Pad

Touch this pad to select baking with the convection function.

16. **CLEAR/OFF** Pad

Touch this pad to cancel **ALL** oven operations except the clock and timer.

## Special features of your oven control

Your new touch pad control has additional features that you may choose to use. The following are the features and how you may activate them.

The special feature modes can only be activated while the display is showing the time of day. They remain in the control's memory until the steps are repeated.

When the display shows your choice, touch the **START** pad. The special features will remain in memory after a power failure.

### 12 Hour Shut-Off

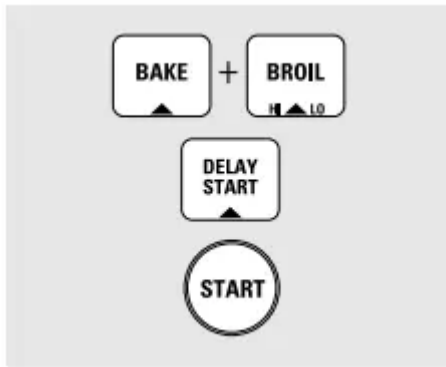

With this feature, should you forget and leave the oven on, the control will automatically turn off the oven after 12 hours during baking functions or after 3 hours during a broil function.

If you wish to turn **OFF** this feature, follow the steps below.

1. Touch the **BAKE** and **BROIL HI/LO** pads at the same time for 3 seconds until the display shows **SF**.
2. Touch the **DELAY START** pad. The display will show 12 shdn (12 hour shut-off). Touch the **DELAY START** pad again and the display will show no shdn (no shut-off).
3. Touch the **START** pad to activate the no shut-off and leave the control set in this special features mode.

### Fahrenheit or Celsius Temperature Selection

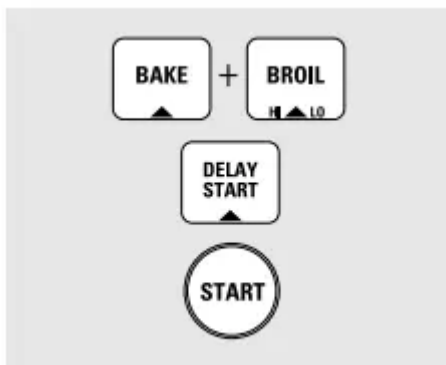

Your oven control is set to use the Fahrenheit temperature selections but you may change this to use the Celsius selections.

1. Touch the **BAKE** and **BROIL HI/LO** pads at the same time for 3 seconds until the display shows **SF**.
2. Touch the **BROIL HI/LO** pad. The display will show **F** (Fahrenheit).
3. Touch the **BROIL HI/LO** pad again. The display will show **C** (Celsius).

4. Touch the **START** pad.

### Tones at the End of a Timed Cycle

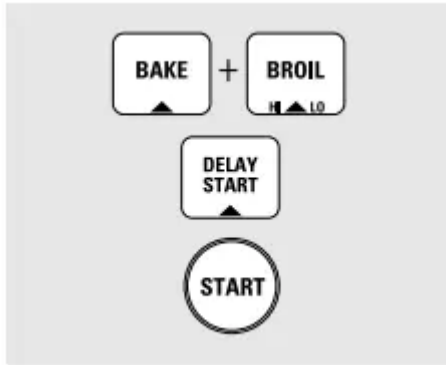

At the end of a timed cycle, 3 short beeps will sound followed by one beep every 6 seconds until the CLEAR/OFF pad is touched. This continual 6 second beep may be canceled.

To cancel the 6 second beep:

1. Touch the **BAKE** and **BROIL HI/LO** pads at the same time for 3 seconds until the display shows **SF**.
2. Touch the **KITCHEN TIMER ON/OFF** pad. The display shows **CON BEEP** (continual beep). Touch the **KITCHEN TIMER ON/OFF** pad again. The display shows **BEEP**. (This cancels the one beep every 6 seconds.)
3. Touch the **START** pad.

### Control Lockout (on some models)

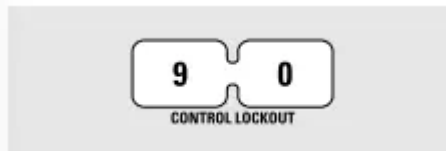

Your control will allow you to lock out the touch pads so they cannot be activated when touched or cleaning the glass panel.

To activate this feature:

1. Touch the **9** and **0** touch pads at the same time for 3 seconds until the control beeps twice. The display will show **LOC** continuously and the time of day if not blacked out.

**NOTE:** All cooking and timing functions will be cancelled when locking out the control.

2. To unlock the control, touch the **9** and **0** touch pads at the same time for 3 seconds until the control beeps twice, and **LOC** will be removed from the display.

### 12 Hour, 24 Hour or Clock Black-Out

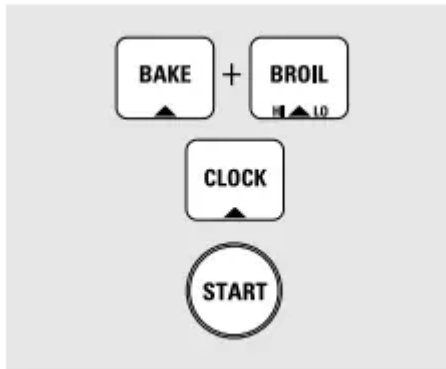

Your control is set to use a 12 hour clock.

If you would prefer to have a 24 hour military time clock or black-out the clock display, follow the steps below.

1. Touch the **BAKE** and **BROIL HI/LO** pads at the same time for 3 seconds until the display shows **SF**.
2. Touch the **CLOCK** pad once. The display will show 12 hr. If this is the choice you want, touch the **START** pad.

Touch the **CLOCK** pad again to change to the 24 hour military time clock. The display will show 24 hr. If this is the choice you want, touch the **START** pad.

Touch the **CLOCK** pad again to black-out the clock display. The display will show **OFF**. If this is the choice you want, touch the **START** pad.

**NOTE:** If the clock is in the black-out mode you will not be able to use the Delay Start function.

### Cook and Hold

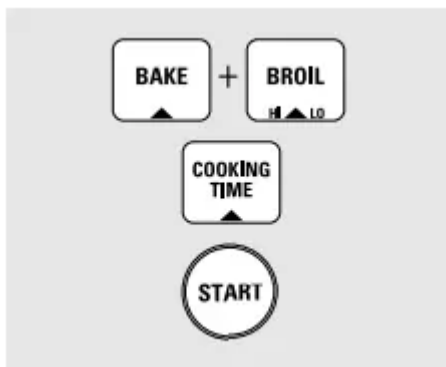

Your new control has a cook and hold feature that keeps cooked foods warm for up to 3 hours after the cooking function is finished.

To activate this feature, follow the steps below.

1. Touch the **BAKE** and **BROIL HI/LO** pads at the same time for 3 seconds until the display shows **SF**.
2. Touch the **COOKING TIME** pad. The display will show **Hid OFF**.

Touch the **COOKING TIME** pad again to activate the feature. The display will show **Hid ON**.

3. Touch the **START** pad to activate the cook and hold feature and leave the control set in this special features mode.

### Using Convection Conversion

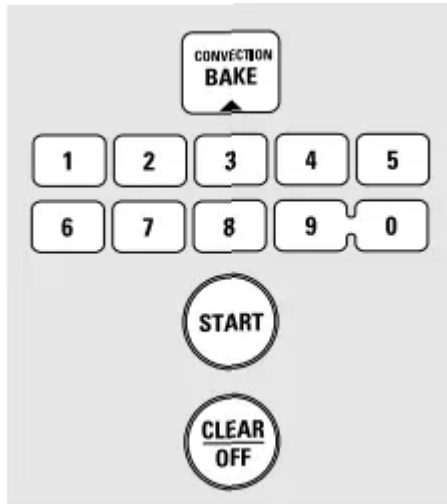

By using the Convection Conversion feature you can automatically convert the oven temperature from regular baking to Convection Bake temperatures.

To convert the oven temperature for convection baking, follow the steps below.

1. Touch and hold the **CONVECTION BAKE** pad for 4 to 5 seconds.
2. Using the number pads, enter the temperature recommended in the recipe.
3. Touch the **START** pad.

The display shows the converted (reduced) temperature. For example, if you entered a recipe temperature of 350°F., the display will show 325°F. when it is converted.

4. Touch the **CLEAR/OFF** pad when baking is finished.

**NOTE:** Conversion must be set each time you want to use it. It is not held in memory

### Using the oven

To avoid possible burns, place the shelves in the desired position before you turn the oven on.

*The oven has 6 shelf positions*

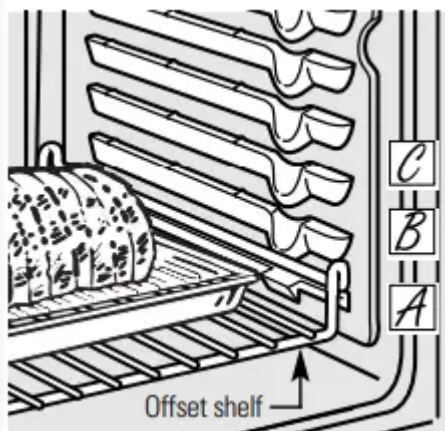
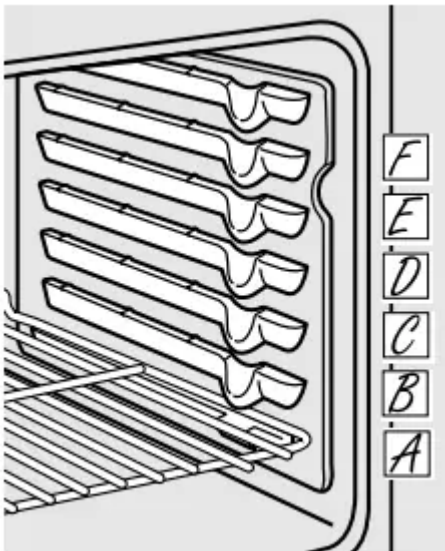

Type of Food	Shelf Position
Frozen pies (on cookie sheet)	D
Angel food cake, bundt or pound cakes	D
Biscuits, muffins, brownies, cookies, cupcakes, layer cakes, pies	C or D
Casseroles	C or D
Turkey or roast on offset shelf	A

### Before you begin

The shelves have stops, so that when placed correctly on the supports, they will stop before coming completely out, and will not tilt.

When placing and removing cookware, pull the shelf out until it stops.

On some models, the bake heating element is under the oven floor. Do not place foods on the oven bottom for cooking.

**To remove a shelf**, pull it toward you, tilt the front end up and pull it out.

**To replace**, place the end of the shelf (stop-locks) on the support, tilt up the front and push the shelf in.

**CAUTION:** When you are using the shelf in the lowest position (A), you will need to use caution when pulling the shelf out. We recommend that you pull the shelf out several inches and then, using two pot holders, pull the shelf out by holding the sides of it. The shelf is low and you could be burned if you place your hand in the middle of the shelf and pull all the way out. Be very careful not to burn your hand on the door when using the shelf in the lowest position (A).

### How to Set the Oven for Baking or Roasting

1. Touch the **BAKE** pad.
2. Touch the number pads to set the desired temperature.
3. Touch the **START** pad.
4. Check food for doneness at minimum time on recipe. Cook longer if necessary.
5. Touch the **CLEAR/OFF** pad when cooking is complete.

### Preheating and Pan Placement

Preheat the oven if the recipe calls for it. Preheating is necessary for good results when baking cakes, cookies, pastry and breads.

To preheat, set the oven at the correct temperature. The control will beep when the oven is preheated and the display will show your set temperature. This will take approximately 15–20 minutes.

Baking results will be better if baking pans are centered in the oven as much as possible. If baking with more than one pan, place the pans so each has at least 1" to 1 1/2" of air space around it. If baking four cake layers at the same time, place two layers on rack B and two layers on rack D. Stagger pans on the rack so one is not directly above the other.

*Do not place foods directly on the oven floor.*



### Aluminum Foil

You can use aluminum foil to line the broiler pan and broiler grid. However, you must mold the foil tightly to the grid and cut slits in it just like the grid.

Without the slits, the foil will prevent fat and meat juices from draining into the broiler pan. The juices could become hot enough to catch on fire. If you do not cut the slits, you are essentially frying, not broiling.

Do not use aluminum foil on the bottom of the oven.

Never entirely cover a shelf with aluminum foil. This will disturb the heat circulation and result in poor baking. A smaller sheet of foil may be used to catch a spillover by placing it on a lower shelf several inches below the food.

*Cut slits in the foil just like the grid.*

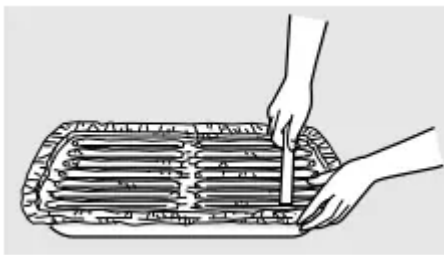

## Using the clock and timer

### To Set the Clock

The clock must be set to the correct time of day for the automatic oven timing functions to work properly. The time of day cannot be changed during a timed baking or self-cleaning cycle.

Touch the **CLOCK** pad.

Touch the number pads.

Touch the **START** pad until the time of day shows in the display.

*Make sure the clock is set to the correct time of day.*



### To Set the Timer

1. Touch the **KITCHEN TIMER ON/OFF** pad.

2. Touch the number pads until the amount of time you want shows in the display. For example, to set 2 hours and 45 minutes, touch **2**, **4** and **5** in that order. If you make a mistake touch the **KITCHEN TIMER ON/OFF** pad and begin again.

3. Touch the **START** pad.

4. When the timer reaches :00, the control will beep 3 times followed by one beep every 6 seconds until the **KITCHEN TIMER ON/OFF** pad is touched.

The 6 second tone can be canceled by following the steps in the Special features of your oven control section under Tones at the End of a Timed Cycle.

*The timer is a minute timer only. The timer does not control oven operations. The maximum setting on the timer is 9 hours and 59 minutes.*



### To Reset the Timer

If the display is still showing the time remaining, you may change it by touching the **KITCHEN TIMER ON/OFF** pad, then touch the number pads until the time you want appears in the display.

If the remaining time is not in the display (clock, delay start or cooking time are in the display), recall the remaining time by touching the **KITCHEN TIMER ON/OFF** pad and then touching the number pads to enter the new time you want.

### To Cancel the Timer

Touch the **KITCHEN TIMER ON/OFF** pad twice.

## Using the timed baking and roasting features

**NOTE:** Foods that spoil easily—such as milk, eggs, fish, stuffings, poultry and pork—should not be allowed to sit for more than 1 hour before or after cooking. Room temperature promotes the growth of harmful bacteria. Be sure that the oven light is off because heat from the bulb will speed harmful bacteria growth.

### How to Set an Immediate Start and Automatic Stop

The oven will turn on immediately and cook for a selected length of time. At the end of the cooking time the oven will turn off automatically.

1. Touch the **BAKE** pad.

2. Using the number pads, enter the desired temperature.

3. Touch the **COOKING TIME** pad.

**NOTE:** If your recipe requires preheating, you may need to add additional time to the length of the cooking time.

4. Using the number pads, enter the desired baking time. The oven temperature and the cooking time that you entered will be displayed.

5. Touch the **START** pad.

The word **ON** and **100°** will be displayed. The cook time will begin to count down. As the oven heats up, the display will show the changing temperature. When the oven reaches the temperature you set, 3 beeps will sound.

At the end of timed baking, the oven will turn off. The end of cycle tone will sound.

Touch the **CLEAR/OFF** pad to clear the display.

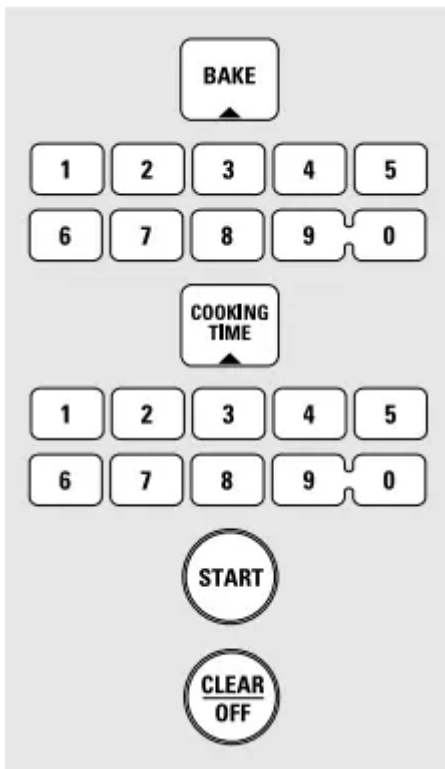

### How to Set a Delayed Start and Automatic Stop

You can set the oven control to delay-start the oven, cook for a specific length of time and then turn off automatically. Make sure the clock shows the correct time of day.

1. Touch the **BAKE** pad.

2. Using the number pads, enter the desired temperature.

3. Touch the **COOKING TIME** pad.

**NOTE:** If your recipe requires preheating, you may need to add additional time to the length of the cooking time.

4. Using the number pads, enter the desired baking time.
5. Touch the **DELAY START** pad.
6. Using the number pads, enter the time of day you want the oven to turn on and start cooking.
7. Touch the **START** pad.

**NOTE:** An attention tone will sound if you are using timed baking and do not touch the **START** pad after entering the baking temperature.

If you would like to check the times you have set, touch the **DELAY START** pad to check the start time you have set or touch the **COOKING TIME** pad to check the length of cooking time you have set.

The oven will turn on automatically. The word **ON** and **100°** will be displayed. The cook time will begin to count down.

As the oven heats up, the display will show the changing temperature. The oven will cook for the programmed cooking time and shut off automatically.

At the end of timed baking, the oven will turn off. The end of cycle tone will sound.

Touch the **CLEAR/OFF** pad to clear the display

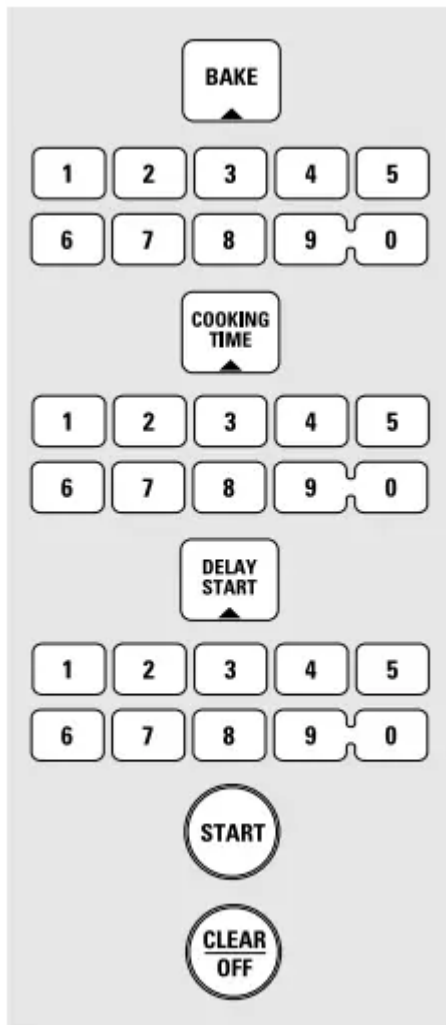

### Using the probe (on some models)

For many foods, especially roasts and poultry, internal food temperature is the best test for doneness. The temperature probe takes the guesswork out of roasting by cooking foods to the exact doneness you want.

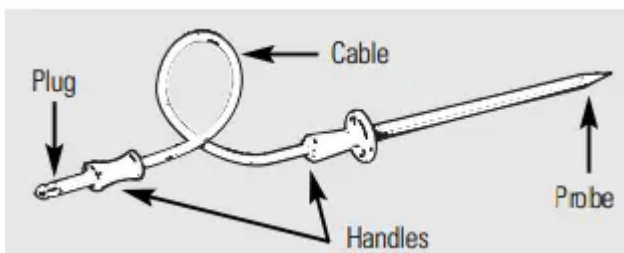

*The temperature probe has a skewer-like probe at one end and a plug at the other end that goes into the outlet in the oven.*

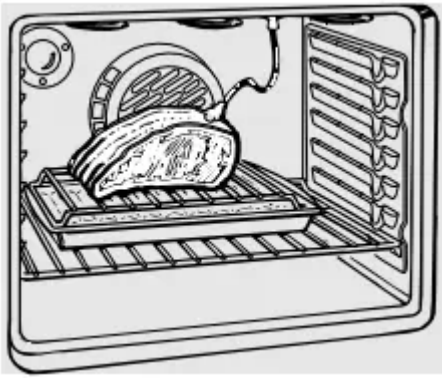

Use of probes other than the one provided with this product may result in damage to the probe.

Use the handles of the probe and plug when inserting and removing them from the food and outlet.

- To avoid damaging your probe, do not use tongs to pull on the cable when removing it.
- To avoid breaking the probe, make sure food is completely defrosted before inserting.
- To prevent possible burns, do not unplug the probe from the outlet until the oven has cooled.
- Never leave your probe inside the oven during a self-cleaning cycle.
- Do not store the probe in the oven.

After preparing the meat and placing it on a trivet or on the broiler pan grid, follow these directions for proper probe placement.

Insert the probe completely into the meat. It should not touch the bone, fat or gristle. For roasts with no bone, insert the probe into the meatiest part of the roast.

For bone-in ham or lamb, insert the probe into the center of the lowest large muscle.

Insert the probe into the center of dishes such as meat loaf or casseroles.

Insert the probe into the meatiest part of the inner thigh from below and parallel to the leg of a whole turkey.

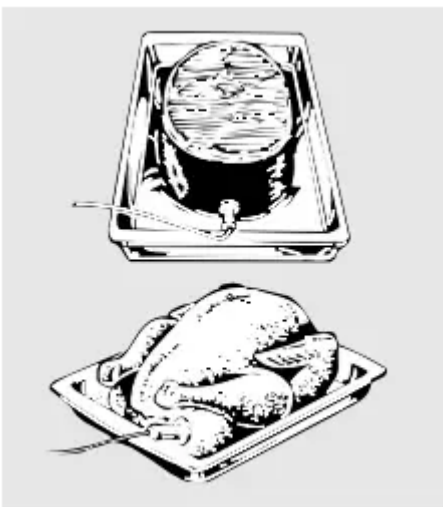

## How to Set the Oven For Roasting When Using the Probe (on some models)

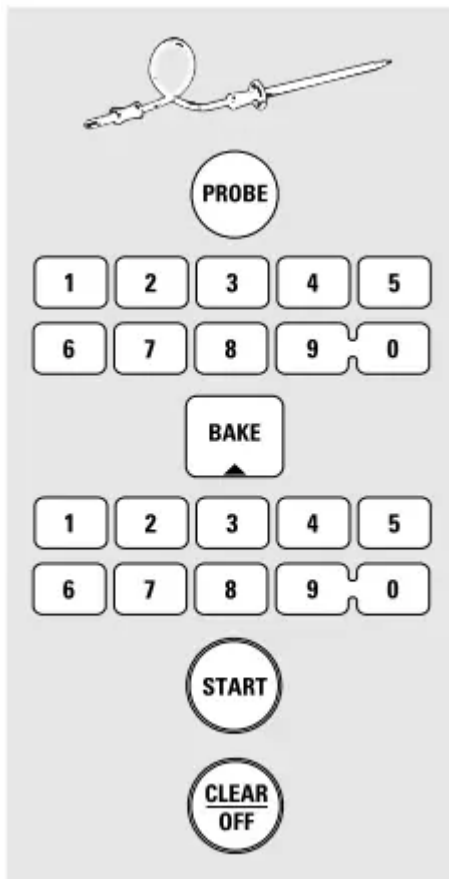

1. Insert the probe into the food.
2. Plug the probe into the outlet in the oven. Make sure it's pushed all the way in. Close the oven door. Make sure the probe cable is not touching the broil element.
3. Touch the **PROBE** pad.
4. Touch the number pads to set the desired internal food or meat temperature.
5. Touch the **BAKE** pad.
6. Touch the number pads to set the desired oven temperature.
7. Touch the **START** pad.

The display will flash if the probe is inserted into the outlet and you have not set a probe temperature and touched the **START** pad.

After the internal temperature of the food reaches 100°F., the changing internal temperature will be shown in the display.

8. When the internal temperature of the food reaches the number you have set, the probe and the oven turn off and the oven control signals. To stop the signal, touch the **CLEAR/OFF** pad. Use hot pads to remove the probe from the food. Do not use tongs to pull on it—they might damage it.

To change the oven temperature during the Roast cycle, touch the **BAKE** pad and then the number pads to set the new temperature.

- If the probe is removed from the food before the final temperature is reached, a tone will sound and the display will flash until the probe is removed from the oven.
- You can use the timer even though you cannot use timed oven operations while using the probe.

## Using the convection oven

The convection oven fan shuts off when the oven door is opened. DO NOT leave the door open for long periods of time while using convection cooking or you may shorten the life of the convection heating element.

*In a convection oven, a fan circulates hot air over, under and around the food. This circulating hot air is evenly distributed throughout the oven cavity. As a result, foods are evenly cooked and browned—often in less time than with regular heat.*

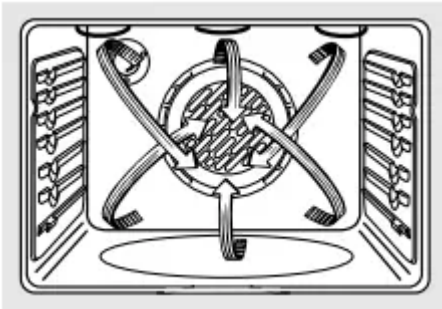

To help you understand the difference between convection bake and roast and traditional bake and roast, here are some general guidelines.

### Convection Bake

- Ideal for evenly browned baked foods cooked on multiple shelves.
- Good for large quantities of baked foods.
- Good results with cookies, biscuits, brownies, cupcakes, cream puffs, sweet rolls, angel food cake and bread.

Heat comes from the heating element in the rear of the oven. The convection fan circulates the heated air evenly over and around the food. Preheating is not necessary with foods having a bake time of over 15 minutes.

### Convection Roast

- Good for large tender cuts of meat, uncovered.

Heat comes from the top heating element. The convection fan circulates the heated air evenly over and around the food. Meat and poultry are browned on all sides as if they were cooked on a rotisserie. Using the roasting rack provided, heated air will be circulated over,

under and around the food being roasted. The heated air seals in juices quickly for a moist and tender product while, at the same time, creating a rich golden brown exterior.

Roasts or poultry should be cooked on the lowest shelf position (A) on a shelf.

When you are convection roasting it is important that you use the broiler pan and grid and the special roasting rack for best convection roasting results. The pan is used to catch grease spills and the grid is used to prevent grease splatters. Place the meat on the special roasting rack. The rack holds the meat. The rack allows the heated air to circulate under the meat and increase browning on the underside of the meat or poultry.

- Place the shelf in the lowest shelf position (A).
- Place the grid on the broiler pan and put the roasting rack over them making sure the posts on the roasting rack fit into the holes in the broiler pan.

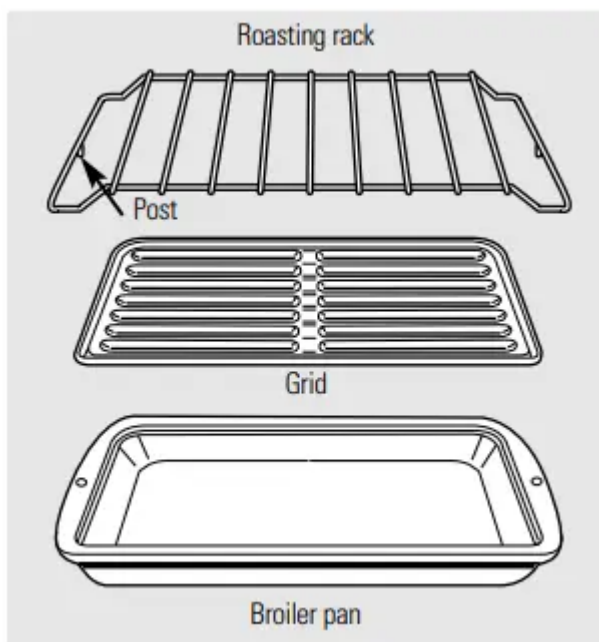

### Adapting Recipes...

You can use your favorite recipes in the convection oven.

When baking, reduce baking temperature by 25°F.

No need to preheat when cooking longer than 15 minutes.

- For more information on adapting recipes, see the Convection Cookbook.
- Use pan size recommended.
- Some package instructions for frozen casseroles or main dishes have been developed using commercial convection ovens. For best results in this oven, preheat the oven and use the temperature on the package.

### Cookware for Convection Cooking

Before using your convection oven, check to see if your cookware leaves room for air circulation in the oven. If you are baking with several pans, leave space between them. Also, be sure the pans do not touch each other or the walls of the oven.

### Paper and Plastic

Heat-resistant paper and plastic containers that are recommended for use in regular ovens can be used in convection ovens. Plastic cookware that is heat-resistant to temperatures of 400°F. can also be used, when oven is below 400°F.

### Metal and Glass

Any type of cookware will work in your convection oven. However, metal pans heat the fastest and are recommended for convection baking.

- Darkened or matte-finished pans will bake faster than shiny pans.
- Glass or ceramic pans cook more slowly.

When baking cookies, you will get the best results if you use a flat cookie sheet instead of a pan with low sides.

For recipes like oven-baked chicken, use a pan with low sides. Hot air cannot circulate well around food in a pan with high sides.

### How to Set the Oven for Convection Baking or Roasting

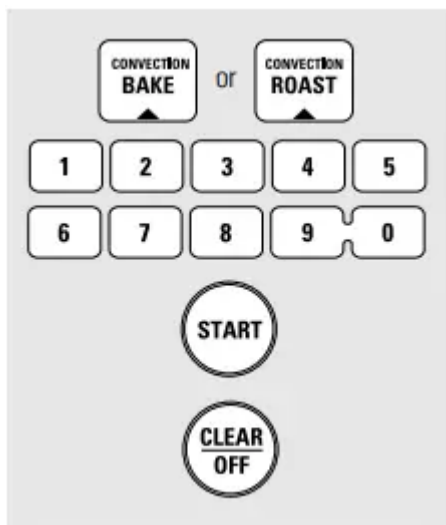

1. Touch the **CONVECTION BAKE** or **CONVECTION ROAST** pad.
2. Touch the number pads to set the desired oven temperature.
3. Touch the **START** pad.

To change the oven temperature, touch the **CONVECTION BAKE** or **CONVECTION ROAST** pad and then the number pads to set the new temperature.

When the oven starts to heat the changing temperature, starting at 100°F., will be displayed. When the oven reaches the temperature you set, 3 beeps will sound.

4. Touch the **CLEAR/OFF** pad when finished.

**NOTE:** You will hear a fan while cooking with convection. The fan will stop when the door is opened but the heat will not turn off.

### Multi-Shelf Baking

Because heated air is circulated evenly throughout the oven, foods can be baked with excellent results using multiple shelves.

Multi-shelf baking may increase cook times slightly for some foods but the overall result is time saved. Cookies, muffins, biscuits, and other quick breads give very good results with multi-shelf baking.

When baking on 3 shelves, place one shelf in the bottom (A) position, one on the 4th (D) position and the offset shelf in the 6th (F) position.

*When convection baking with only 1 shelf, follow the shelf positions recommended in the Using the oven section.*

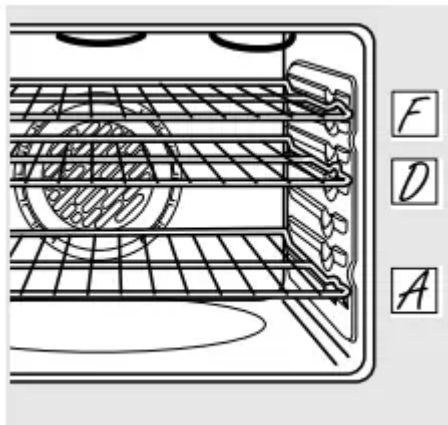

### How to Set the Oven for Convection Roasting when Using the Probe (on some models)

*For best results when roasting large turkeys and roasts, we recommend using the probe included in the convection oven.*



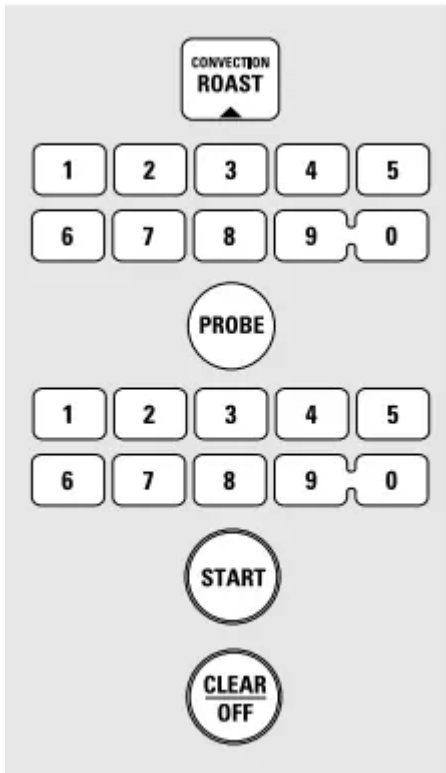

1. The display will flash **PROBE** and the oven control will signal if the probe is inserted into the outlet, and you have not set a probe temperature and touched the **START** pad.
2. Place the shelf in the lowest position (A). Insert the probe into the food.
3. Plug the probe into the outlet in the oven. Make sure it is pushed all the way in. Close the oven door. Touch the **CONVECTION ROAST** pad.
4. Touch the number pads to set the desired oven temperature.
5. Touch the **PROBE** pad.
6. Touch the number pads to set the desired internal food temperature.

To change the oven temperature during the Convection Roast cycle, touch the **CONVECTION ROAST** pad and then touch the number pads to set the new desired temperature.

7. Touch the **START** pad.

When the oven starts to heat, the word **LO** will be in the display.

After the internal temperature of the food reaches 100°F., the changing internal temperature will be shown in the display.

8. When the internal temperature of the food reaches the number you have set, the probe and the oven turn off and the oven control signals. To stop the signal, touch the **CLEAR/OFF** pad. Use hot pads to remove the probe from the food. Do not use tongs to pull on it— they might damage it.

**CAUTION:** To prevent possible burns, do not unplug the probe from the oven outlet until the oven has cooled. Do not store the probe in the oven.

**NOTE:**

- If the probe is removed from the food before the final temperature is reached, a tone will sound and the display will flash until the probe is removed from the oven.
- You will hear a fan while cooking with this feature. The fan will stop when the door is opened but the heat will not turn off.
- You can use the timer even though you cannot use timed oven operations while using the probe.

### Using the timed features for convection baking

You will hear a fan while cooking with this feature. The fan will stop when the door is opened but the heat will not turn off.

**NOTE:** Foods that spoil easily—such as milk, eggs, fish, stuffings, poultry and pork—should not be allowed to sit for more than 1 hour before or after cooking. Room temperature promotes the growth of harmful bacteria. Be sure that the oven light is off because heat from the bulb will speed harmful bacteria growth.

#### How to Set an Immediate Start and Automatic Stop

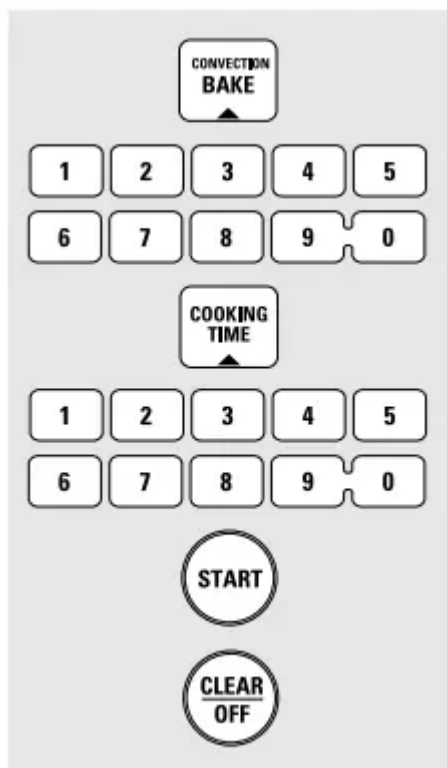

The oven will turn on immediately and cook for a selected length of time. At the end of the cooking time the oven will turn off automatically.

1. Touch the **CONVECTION BAKE** pad.
2. Touch the number pads to set the desired oven temperature.
3. Touch the **COOKING TIME** pad.

**NOTE:** If your recipe requires preheating, you may need to add additional time to the length of the cooking time.

4. Touch the number pads to set the desired length of cooking time. The minimum cooking time you can set is 1 minute.

The oven temperature that you set and the cooking time that you entered will be in the display.

5. Touch the **START** pad.

The display shows the oven temperature that you set and the cooking time countdown. The display starts changing once the temperature reaches 100°F.

6. At the end of timed convection bake the oven will turn off. The end of cycle tone will sound. Touch the **CLEAR/OFF** pad to clear the display if necessary.

7. Remove the food from the oven. Remember, foods that are left in the oven continue cooking after the controls are off.

### **How to Set a Delayed Start and Automatic Stop**

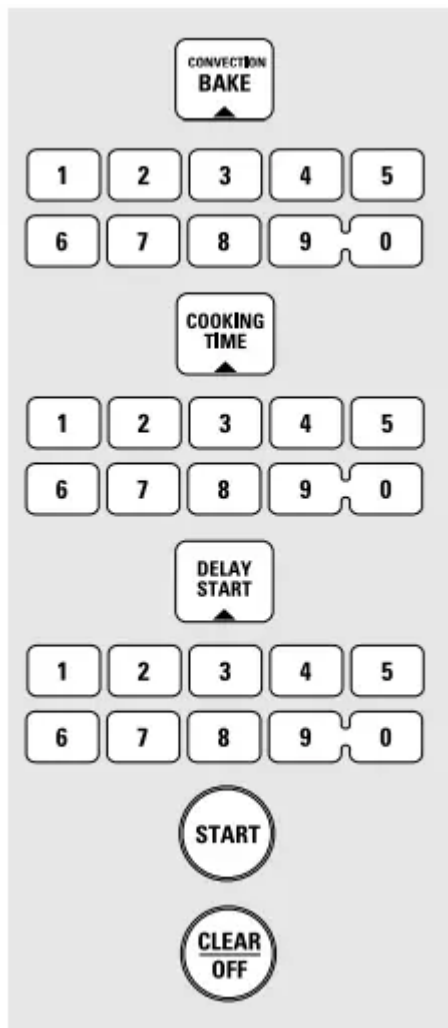

You can set the oven control to delay-start the oven, cook for a specific length of time and then turn off automatically.

Make sure the clock shows the correct time of day.

1. Touch the CONVECTION BAKE pad.
2. Touch the number pads to set the desired oven temperature.
3. Touch the COOKING TIME pad.

**NOTE:** If your recipe requires preheating, you may need to add additional time to the length of the cooking time.

4. Touch the number pads to set the desired cooking time.
5. Touch the DELAY START pad.
6. Touch the number pads to set the time of day you want the oven to turn on and start cooking.

If you would like to check the times you have set, touch the **DELAY START** pad to check the start time you have set or touch the **COOKING TIME** pad to check the length of cooking time you have set.

7. Touch the **START** pad.

**NOTE:** An attention tone will sound if you are using timed baking and do not touch the START pad after entering the baking temperature.

When the oven turns on at the time of day you have set, the display will show the changing temperature (starting at 100°F.) and the cooking time countdown.

At the end of timed convection bake the oven will turn off. The end of cycle tone will sound.

8. Touch the **CLEAR/OFF** pad to clear the display if necessary. When baking is finished, remove the food from the oven. Remember, even though the oven shuts off automatically, foods continue cooking after the controls are off.

### Adjust the oven thermostat—Do it yourself!

You may find that your new oven cooks differently than the one it replaced. Use your new oven for a few weeks to become more familiar with it. If you still think your new oven is too hot or too cold, you can adjust the thermostat yourself.

Do not use thermometers, such as those found in grocery stores, to check the temperature setting of your oven. These thermometers may vary 20–40 degrees.

**NOTE:** This adjustment will not affect the broiling or the self-cleaning temperatures. The adjustment will be retained in memory after a power failure.

#### To Adjust the Thermostat

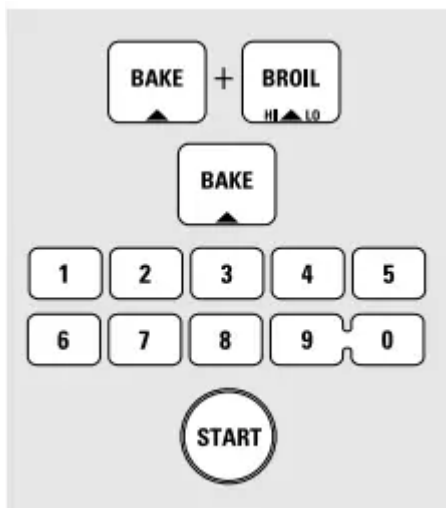

1. Touch the **BAKE** and **BROIL HI/LO** pads at the same time for 3 seconds until the display shows **SF**.

2. Touch the **BAKE** pad. A two digit number shows in the display.

Touch **BAKE** once to decrease (-) the oven temperature, or twice to increase (+).

3. The oven temperature can be adjusted up as much as 35°F. or down as much as 35°F. Touch the number pads the same way you read them. For example, to change the oven temperature 15°F., touch **1** and **5**.

4. When you have made the adjustment, touch the **START** pad to go back to the time of day display. Use your oven as you would normally.

**NOTE:** The thermostat adjustment for Baking will also affect Convection Baking or Convection Roasting.

## The type of margarine will affect baking performance!

Most recipes for baking have been developed using high fat products such as butter or margarine (80% fat). If you decrease the fat, the recipe may not give the same results as with a higher fat product.

Recipe failure can result if cakes, pies, pastries, cookies or candies are made with low fat spreads. The lower the fat content of a spread product, the more noticeable these differences become.

Federal standards require products labeled “margarine” to contain at least 80% fat by weight. Low fat spreads, on the other hand, contain less fat and more water. The high moisture content of these spreads affects the texture and flavor of baked goods. For best results with your old favorite recipes, use margarine, butter or stick spreads containing at least 70% vegetable oil.

## Using the self-cleaning oven

The oven door must be closed and all controls set correctly for the cycle to work properly.

### Before a Clean Cycle

*Wipe up heavy soil on the oven bottom.*



We recommend venting your kitchen with an open window or using a ventilation fan or hood during the first self-clean cycle.

Remove the shelves, broiler pan, broiler grid, probe, all cookware and any aluminum foil from the oven.

The oven shelves and convection roasting rack can be self-cleaned, but they will darken, lose their luster and become hard to slide.

Soil on the front frame of the range and outside the gasket on the door will need to be cleaned by hand. Clean these areas with hot water, soap-filled steel-wool pads or cleansers such as Soft Scrub®. Rinse well with clean water and dry.

Do not clean the gasket. The fiberglass material of the oven door gasket cannot withstand abrasion. It is essential for the gasket to remain intact. If you notice it becoming worn or frayed, replace it.

Wipe up any heavy spillovers on the oven bottom.

Make sure the oven light bulb cover is in place and the oven light is off.

**IMPORTANT:** The health of some birds is extremely sensitive to the fumes given off during the self-cleaning cycle of any range. Move birds to another well ventilated room.

### How to Set the Oven for Cleaning

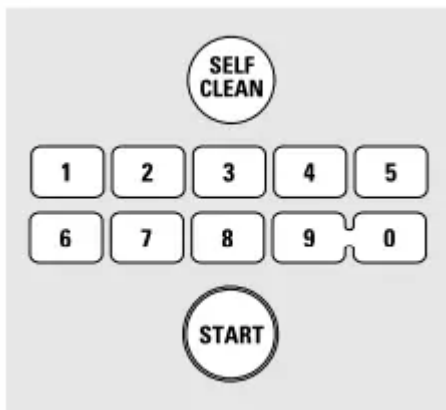

1. Touch the **SELF CLEAN** pad.

2. Using the number pads, enter the desired clean time, if a time other than 4 hours, 30 minutes is needed.

Clean cycle time is normally 4 hours, 30 minutes. You can change the clean time to any time between 3 hours and 5 hours, depending on how dirty your oven is.

3. Touch the **START** pad.

The door locks automatically. The display will show the clean time remaining. It will not be possible to open the oven door until the temperature drops below the lock temperature and the **LOCKED DOOR** light goes off.

When the **LOCKED DOOR** light is off, open the door.

The oven shuts off automatically when the clean cycle is complete.

- The words **LOCK DOOR** will flash and the oven control will signal if you set the clean cycle and forget to close the oven door.
- To stop a clean cycle, touch the **CLEAR/OFF** pad. When the **LOCKED DOOR** light goes off indicating the oven has cooled below the locking temperature, open the door.

### How to Delay the Start of Cleaning

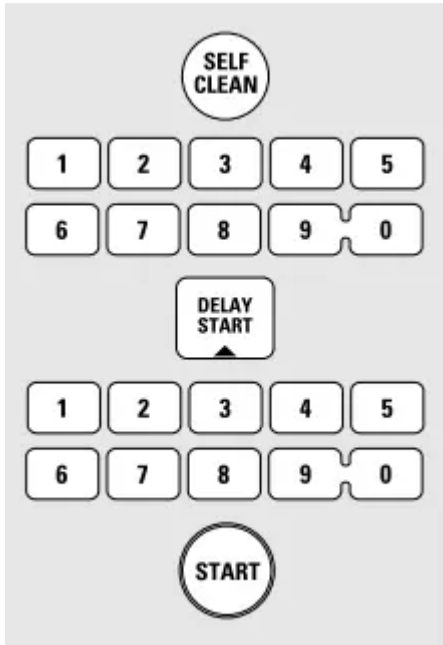

Make sure the clock shows the correct time of day.

1. Touch the **SELF CLEAN** pad.
2. Using the number pads, enter the desired clean time.
3. Touch the **DELAY START** pad. The earliest start time you can set will appear in the display.
4. Using the number pads, enter the time of day you want the clean cycle to start.
5. Touch the **START** pad.

The door locks automatically. The display will show the start time. It will not be possible to open the oven door until the temperature drops below the lock temperature and the **LOCKED DOOR** light goes off.

When the **LOCKED DOOR** light is off, open the door.

### After a Clean Cycle

You may notice some white ash in the oven. Wipe it up with a damp cloth after the oven cools.

If white spots remain, remove them with a soapfilled steel wool pad and rinse thoroughly with a vinegar and water mixture.

These deposits are usually a salt residue that cannot be removed by the clean cycle.

If the oven is not clean after one clean cycle, repeat the cycle.

- You cannot set the oven for cooking until the oven is cool enough for the door to unlock.
- While the oven is self-cleaning, you can touch the **CLOCK** pad to display the time of day. To return to the clean countdown, touch the **COOKING TIME** pad.
- If the shelves become hard to slide, apply a small amount of vegetable oil or cooking oil to a paper towel and wipe the edges of the oven shelves with the paper towel.

## Care and Cleaning

### Care and cleaning of the range

Be sure all controls are off and all surfaces are cool before cleaning any part of the range.

If your range is removed for cleaning, servicing or any reason, be sure the anti-tip device is re-engaged properly when the range is replaced. Failure to take this precaution could result in tipping of the range and cause injury.



### How to Remove Packaging Tape

To assure no damage is done to the finish of the product, the safest way to remove the adhesive left from packaging tape on new appliances is an application of a household liquid dishwashing detergent, mineral oil or cooking oil.

Apply with a soft cloth and allow to soak. Wipe dry and then apply an appliance polish to thoroughly clean and protect the surface.

**NOTE:** The plastic tape (on some models) must be removed from all chrome trim. It cannot be removed if it is baked on

### Control Knobs

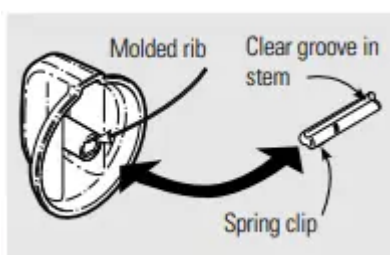

### **To Remove:**

1. Be sure the knob is in the **OFF** position.
2. Pull straight off the stem. Using a piece of string can make removing the knob easier.  
Slip the string under and around the knob, pull straight out.

Wash the knob thoroughly with warm soapy water. Dry completely with a soft cloth. **DO NOT** let the knob soak.

### **To Replace:**

1. Check the back of the knob.
2. The molded rib of the knob is designed to fit perfectly onto the knob stem.
3. Align the molded rib to the clear groove in the knob stem. Push the knob back as far as it will go.

### **Oven Vent**

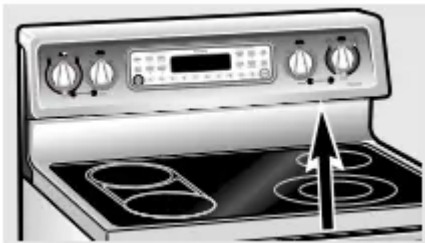

The oven vent is located behind the right rear surface unit.

This area could become hot during oven use.

It is normal for steam to come out of the vent and moisture may collect underneath it when the oven is in use.

The vent is important for proper air circulation. Never block this vent

### **Control Panel**

Deactivate the touch pads before cleaning.

Clean up splatters with a damp cloth.

You may also use a glass cleaner.

Remove heavier soil with warm soapy water. Do not use abrasives of any kind.

Reactivate the touch pads after cleaning.

### **Lift-Off Oven Door**

The oven door is removable for easier access to the light bulb.

Do not lift the door by the handle.

*Pull the hinge locks down to the unlocked position.*

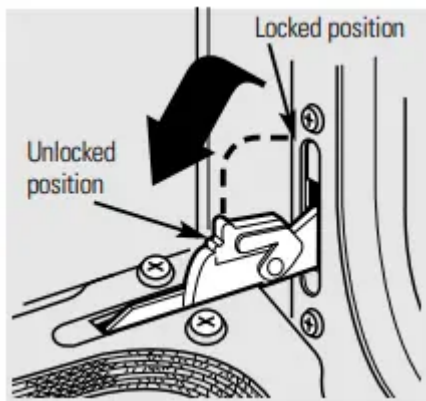

*The gasket is designed with a gap at the bottom to allow for proper air circulation.*

*Do not rub or clean the door gasket—it has an extremely low resistance to abrasion.*

*If you notice the gasket becoming worn, frayed or damaged in any way or if it has become displaced on the door, you should have it replaced.*

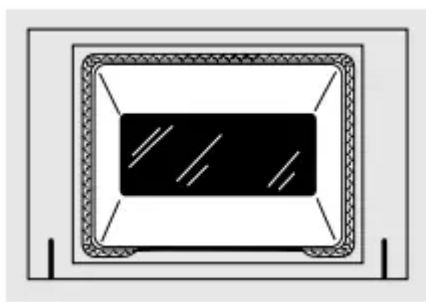

**To remove the door:**

1. Fully open the door.
2. Each hinge has a hinge lock. Using a tool, pull the hinge locks down against the door frame.
3. Firmly grasp the door at the top sides.
4. Close the door to the stop position.
5. Lift the door up and pull straight out.

**To replace the door:**

1. Firmly grasp the door at the top sides. This is critical.
2. Approach the range with the door angled in a vertical position.

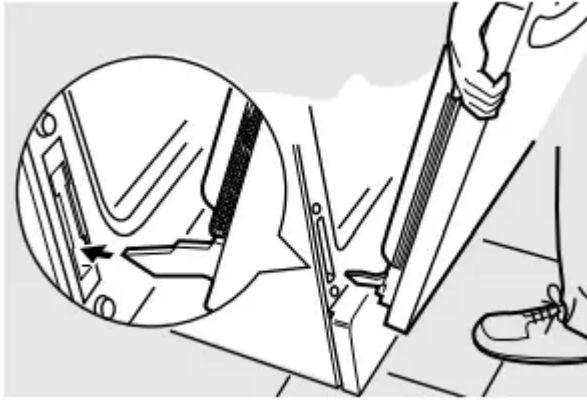

3. Guide the hinges into the slots.

4. Push door in firmly while opening.

5. Once in position, open the door completely. Push the hinge locks back in towards the front frame.

**To clean the inside of the door:**

Because the area inside the gasket is cleaned during the self-clean cycle, you do not need to clean this by hand.

The area outside the gasket and the door liner can be cleaned with a soapfilled steel wool or plastic pad, hot water and detergent. Rinse well with a vinegar and water solution.

**To clean the outside of the door:**

- Use soap and water to thoroughly clean the top, sides and front of the oven door. Rinse well. You may also use a glass cleaner to clean the glass on the outside of the door. Do not let water drip into the vent openings.
- If any stain on the door vent trim is persistent, use a soft abrasive cleaner and a sponge-scrubber for best results.
- Spillage of marinades, fruit juices, tomato sauces and basting materials containing acids may cause discoloration and should be wiped up immediately. When surface is cool, clean and rinse.
- Do not use oven cleaners, cleaning powders or harsh abrasives on the outside of the door

**Oven Shelves and Convection Roasting Rack**

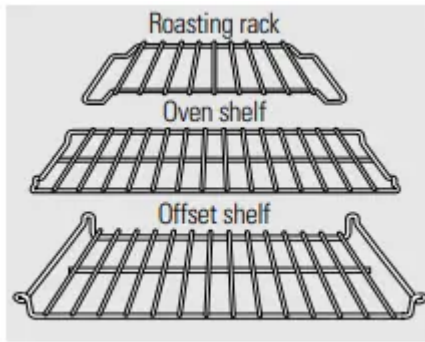

Clean the oven shelves and the convection roasting rack with an abrasive cleanser or steel wool. After cleaning, rinse the shelves and rack with clean water and dry with a clean cloth.

**NOTE:** The oven shelves and convection roasting rack may be cleaned in the selfcleaning oven. However, the shelves will darken in color, lose their luster and become hard to slide if cleaned during the self-cleaning cycle.

To make the shelves slide more easily apply a small amount of vegetable oil or cooking oil to a paper towel and wipe the edges of the oven shelves with the paper towel.

## Oven Light Replacement

*Wire cover holder*

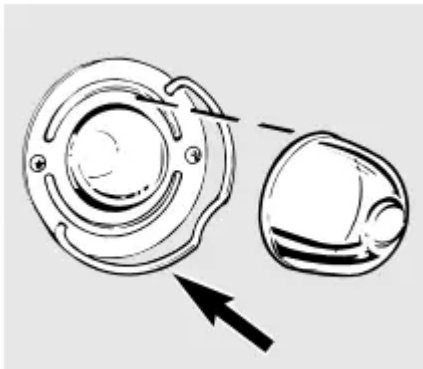

**CAUTION:** Before replacing your oven light bulb, disconnect the electrical power to the range at the main fuse or circuit breaker panel.

Be sure to let the light cover and bulb cool completely.

### To remove the cover:

1. Hold a hand under the cover so it doesn't fall when released. With fingers of the same hand, firmly push back the wire cover holder. Lift off the cover.

Do not remove any screws to remove the cover.

2. Replace bulb with a 40-watt appliance bulb.

### To replace the cover:

1. Place it into groove of the light receptacle. Pull wire forward to the center of the cover until it snaps into place.

2. Connect electrical power to the range.

### **Broiler Pan & Grid**

*Do not store a soiled broiler pan and grid anywhere in the range.*

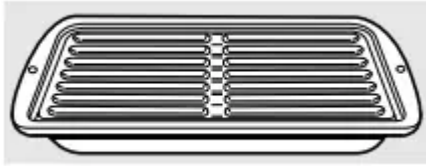

Do not clean the broiler pan or grid in a selfcleaning oven.

After broiling, remove the broiler pan from the oven. Remove the grid from the pan. Carefully pour out the grease from the pan into a proper container.

Wash and rinse the broiler pan and grid in hot water with a soap-filled or plastic scouring pad.

If food has burned on, sprinkle the grid with detergent while hot and cover with wet paper towels or a dishcloth. Soaking the pan will remove burned-on foods.

Both the broiler pan and grid may be cleaned with a commercial oven cleaner.

Both the broiler pan and grid can also be cleaned in a dishwasher.

### **Storage Drawer Removal**

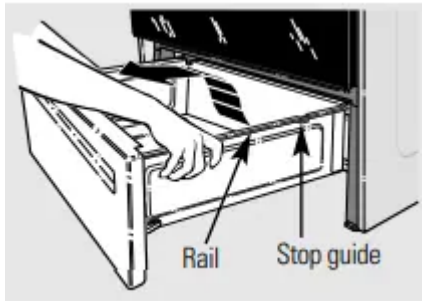

#### **To remove the drawer:**

1. Pull the drawer out until it stops.
2. Lift the front of the drawer until the stops clear the guides.
3. Remove the drawer.

#### **To replace the drawer:**

1. Place the drawer rails on the guides.
2. Push the drawer back until it stops.
3. Lift the front of the drawer and push back until the stops clear the guides.
4. Lower the front of the drawer and push back until it closes.

## Oven Heating Elements

Do not clean the broil element. Any soil will burn off when the element is heated. To clean the oven floor, gently lift the bake element. Clean with warm, soapy water.

On some models, the bake element is not exposed and is under the oven floor. If spillovers, residue or ash accumulate on the oven floor, wipe up before self-cleaning.

## Painted Surfaces

Painted surfaces include the sides of the range and the door, top of control panel and the drawer front. Clean these with soap and water or a vinegar and water solution.

Do not use commercial oven cleaners, cleaning powders, steel wool or harsh abrasives on any painted surface.

## Cleaning the glass cooktop

Clean the glass surface with cleaning cream before you use the cooktop for the first time. Also, clean the glass surface after each use. This helps protect the top and makes clean-up easier.

To clean the cooktop seal around the edge of the glass, let a wet cloth rest on it for a few minutes, then wipe clean. Use a mild detergent if needed.

Do not use a knife or any sharp object on the seal because it will cut or damage it.

## Normal Cleaning

Use only a recommended cleaning cream, such as Cerama Brite or another cooktop cleaning cream, on the glass cooktop.

To maintain and protect the surface of your new glass cooktop follow these steps.

1. Before you use the cooktop for the first time, clean it with cleaning cream. This helps protect the top and makes clean-up easier.
2. Clean the surface with the cleaning cream after each use.
3. Rub a few drops (less is better) of the cleaning cream onto soiled area using a damp paper towel. Buff with a dry paper towel until all soil and cream are removed.

## For Heavy, Burned-On Soil...

*Using a razor scraper will not damage the surface if the 45° angle is maintained.*

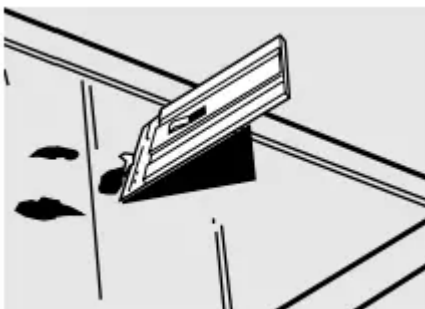

1. Allow the cooktop to cool.
2. Apply a few drops of cleaning cream to the cool, soiled area. Spread the cream across the entire soiled area.
3. Hold scraper at a 45° angle against the glass ceramic surface. This 45° angle makes the scraping easier.
4. Scrape soil with the enclosed razor scraper. Keep small amount of cream on the soil as you scrape. Heavily soiled areas may require repeated applications of cream. It will be necessary to press down on the razor scraper while scraping the soiled area with cooktop cream.

Be sure to use a new sharp razor scraper. Do not use a dull or nicked blade.

5. If any soil remains, repeat the steps listed above.

### **Special Care for Sugary Spills**

Be sure to use a new sharp razor scraper. Do not use a dull or nicked blade.

Sugary spillovers (such as jellies, fudge, candy syrups) or melted plastics can cause pitting of the surface of your cooktop (not covered by the warranty) unless the spill is removed while still hot. Special care should be taken when removing hot substances.

1. Turn off all surface units affected by the spillover. Remove hot pans.
2. Wearing an oven mitt, hold the razor scraper at a 45° angle to the cooktop. Scrape the hot spill to a cool area outside the surface unit.
3. With the spill in a cool area, use a dry paper towel to remove any excess. Any spillover remaining should be left until the surface of the cooktop has cooled. Do not continue to use the soiled surface unit until all of the spillover has been removed. Follow the steps under Heavy Burned-On Soil to continue the cleaning process.

**NOTE:** If pots with a thin overlay of aluminum, copper or enamel are allowed to boil dry, the overlay may bond with the glass cooktop and leave a black discoloration. This should be removed immediately before heating again or the discoloration may be permanent.

## Troubleshooting Tips



Problem	Problem	What To Do
Surface units will not maintain a rolling boil or cooking is not fast enough	Improper cookware being used.	Use pans which are flat and match the diameter of the surface unit selected.
Surface units do not work properly	A fuse in your home may be blown or the circuit breaker tripped.	Replace the fuse or reset the circuit breaker
	Cooktop controls improperly set.	Check to see the correct control is set for the surface unit you are using.
Tiny scratches (may appear as cracks) or abrasions on radiant cooktop glass surface	Incorrect cleaning methods being used.	Use recommended cleaning procedures.
	Cookware with rough bottoms being used or coarse particles (salt or sand) were between the cookware and the surface of the cooktop.	Be sure cookware bottoms and cookware are clean before use. Use cookware with smooth bottoms. Tiny scratches are not removable but will become less visible in time as a result of cleaning.
	Cookware has been slid across the cooktop surface.	
Areas of discoloration on the cooktop	Improper cookware being used.	Marks from aluminum and copper pans as well as mineral deposits from water or food can be removed with the cleaning cream.
	Hot surface on a model with a white glass cooktop.	This is normal. The surface may appear discolored when it is hot. This is temporary and will disappear as the glass cools.
Plastic melted to the surface	Hot cooktop came into contact with plastic placed on the hot cooktop	See the Special Care information in the Cleaning the glass cooktop section.
Pitting of the cooktop	Hot sugar mixture spilled on the cooktop.	Call a qualified technician for replacement

Frequent cycling off and on of surface units		Use only flat cookware to minimize cycling
Oven light does not work	Light bulb is loose or defective.	Tighten or replace the bulb.
	Switch operating • Call for service. light is broken.	Call for service.
Oven will not work	Plug on range is not completely inserted in the electrical outlet.	Make sure electrical plug is plugged into a live, properly grounded outlet.
	A fuse in your home may be blown or the circuit breaker tripped.	Replace the fuse or reset the circuit breaker.
	Oven controls improperly set.	See the Using the oven section
Food does not bake or roast properly	Oven controls improperly set.	See the Using the oven section.
	Shelf position is incorrect or the shelf is not level.	See the Using the oven section.
	Incorrect cookware or cookware of improper size being used.	See the Using the oven section.
	Oven thermostat needs adjustment.	See the Adjust the oven thermostat—Do it yourself! section
Food does not broil properly	Oven controls improperly set.	Make sure you touch the BROIL HI/LO pad.
	Door not open to the broil stop position as recommended.	See the Using the oven section.
	Improper shelf position being used	See the Broiling Guide.
	Cookware not suited for broiling.	Use the broiling pan and grid that came with your range
	The probe is plugged into the outlet in the oven. (on some models)	Unplug and remove the probe from the oven.



	Aluminum foil used on the the broiling pan and grid has not been fitted properly and slit as recommended.	See the Using the oven section
	In some areas the power (voltage) may be low.	Preheat the broil element for 10 minutes.  Broil for the longest period of time recommended in the Broiling Guide.
Oven temperature too hot or too cold	Oven thermostat needs adjustment	See the Adjust the oven thermostat—Do it yourself! section
Storage drawer is crooked	Rear drawer support is on top of the guide rail.	Reposition the drawer. See the Storage Drawer Removal instructions in the Care and cleaning of your range section.
Storage drawer won't close	Power cord may be obstructing drawer in the lower back of the range.	Reposition the drawer and power cord.
	Rear drawer support is on top of the guide rail.	Reposition the drawer.
Clock and timer do not work	Plug on range is not completely inserted in the electrical outlet.	Make sure electrical plug is plugged into a live, properly grounded outlet.
	A fuse in your home may be blown or the circuit breaker tripped.	Replace the fuse or reset the circuit breaker
	Oven controls improperly set	See the Using the clock and timer section.
Oven will not self-clean	The oven temperature is too high to set a self-clean operation.	Allow the range to cool to room temperature and reset the controls.
	Oven controls improperly set	See the Using the self-cleaning oven section.
		Remove the probe from the oven.



	The probe is plugged into the outlet in the oven. (on some models)	
“Crackling” or “popping” sound	This is the sound of the metal heating and cooling during both the cooking and cleaning functions.	This is normal.
Excessive smoking during a clean cycle	Excessive soil.	Touch the CLEAR/OFF pad. Open the windows to rid the room of smoke. Wait until the LOCKED DOOR light goes off. Wipe up the excess soil and reset the clean cycle.
Oven door will not open after a clean cycle	Oven too hot.	Allow the oven to cool below locking temperature
Oven not clean after a clean cycle	Oven controls not properly set.	See the Using the self-cleaning oven section
	Oven was heavily soiled.	Clean up heavy spillovers before starting the clean cycle. Heavily soiled ovens may need to self-clean again or for a longer period of time.
“LOCK DOOR” flashes in the display	The self-clean cycle has been selected but the door is not closed.	Close the oven door.
LOCKED DOOR light is on when you want to cook	The oven door is locked because the temperature inside the oven has not dropped below the locking temperature.	Touch the CLEAR/OFF pad. Allow the oven to cool.
“F—and a number or letter” flash operation.	You have a function error code	Touch the CLEAR/OFF pad. Put the oven back into operation.
	If the function code repeats.	Disconnect all power to the range for at least 30 seconds and then reconnect power. If the function error code repeats, call for service.



Control signals after entering cooking time or start time	You forgot to enter a bake temperature or cleaning time.	Touch the BAKE pad and desired temperature or the SELF CLEAN pad and desired clean time.
Display goes blank	A fuse in your home may be blown or the circuit breaker tripped.	Replace the fuse or reset the circuit breaker
	The clock is in the black-out mode.	See the Special features of your oven control section
Display flashes	Power failure.	Reset the clock.
Unable to get the display to show "SF"	Oven control pads were not touched properly.	The BAKE and BROIL HI/LO pads must be touched at the same time and held for 3 seconds
"Probe" appears in the display	This is reminding you to enter a probe temperature after plugging in the probe.	Enter a probe temperature.
Power outage, clock flashes	Power outage or surge.	Reset the clock. If the oven was in use, you must reset it by touching the CLEAR/OFF pad, setting the clock and resetting any cooking function.
Steam from the vent	When using the convection feature, it is normal to see steam coming out of the oven vent. As the number of shelves or amount of food being cooked increases, the amount of visible steam will increase.	This is normal.
"Burning" or "oily" odor emitting from the vent	This is normal in a new oven and will disappear in time.	To speed the process, set a self-clean cycle for a minimum of 3 hours.
Strong odor	An odor from the insulation around the inside of the oven is normal for the first few times the oven is used.	This is temporary.



Fan noise	A cooling fan or a convection fan (depending on the function you are using) may automatically turn on and off to cool internal parts.	• This is normal. The cooling fan will turn off and on. The convection fan will run until the function is over or the door is opened.
Surface light does not work	Switch operating light is broken.	Call for service.

### **Warning**

This content is compiled from multiple sources and is provided for reference purposes only. It may not be complete or fully applicable to all situations. If you are unable to resolve your issue, please contact the product manufacturer or an authorized service provider for official support.

