

Installation

Follow these instructions carefully to ensure proper installation of the washing machine and to prevent accidents when doing laundry

What's included

Make sure all the parts are included in the product package. If you have a problem with the washing machine or the parts, contact a local Samsung customer centre or the retailer.

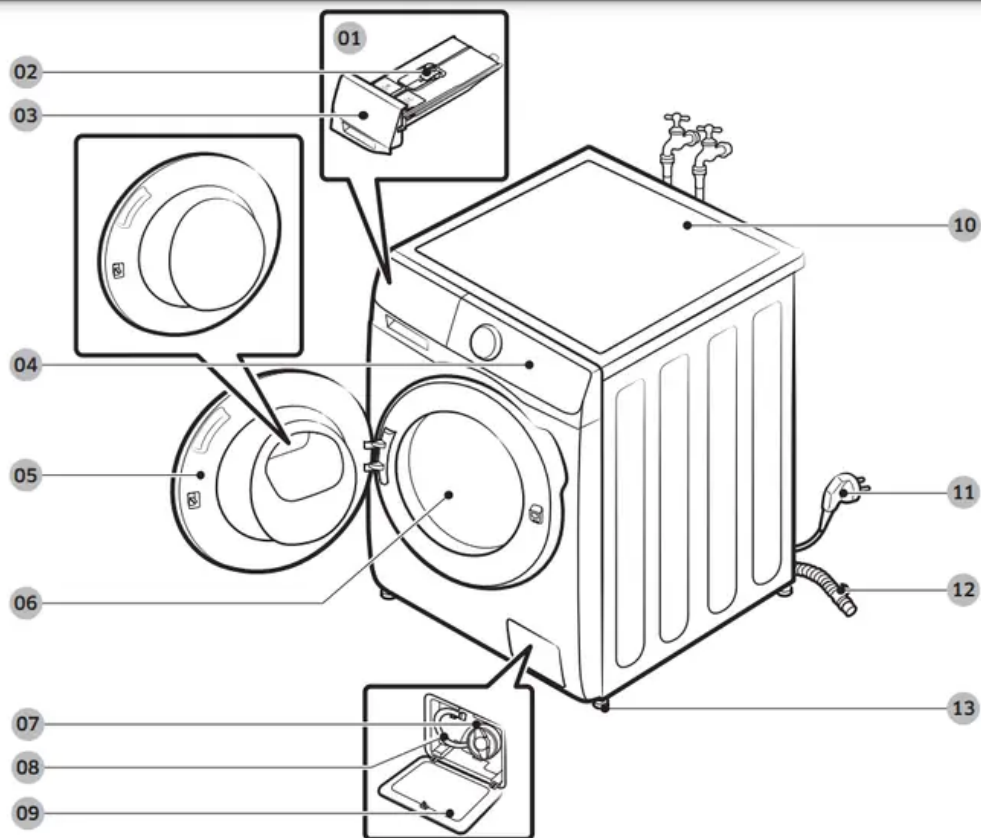

1. Auto dispenser
2. Release lever
3. Detergent drawer
4. Control panel
5. Door
6. Drum
7. Debris filter
8. Emergency drain tube
9. Filter cover

10. Worktop
11. Power plug
12. Drain hose
13. Levelling feet

* The design of the drawer and/or the lever differs with the model.



Spanner



Bolt caps



Hose guide



Cold water hose



Hot water hose

NOTE

- **Spanner:** For removing the shipping bolts and levelling the washing machine.
- **Bolt caps:** For covering the holes after removing the shipping bolts. The provided number of bolt caps (3 to 6) depends on the model.
- **Hose guide:** For hanging the drain hose in the drainpipe or wash-basin.
- **Cold/Hot water hose:** For supplying water to the washing machine. (Hot water hoses is for applicable models only.)

Installation requirements

Electrical supply and grounding

- AC 220-240 V / 50 Hz fuse or circuit breaker is required.
- Use an individual branch circuit specific to the washing machine.

To ensure proper grounding, the washing machine comes with a power cord featuring a three-prong grounding plug for use in a properly installed and grounded outlet. Check with a qualified electrician or service person if you are not sure about the grounding.

Do not modify the provided plug. If it does not fit the outlet, call a qualified electrician to install a suitable outlet.

WARNING

- Do NOT use an extension cord.

- Use only the power cord that comes with the washing machine.
- Do NOT connect the ground wire to plastic plumbing, gas lines, or hot water pipes.
- Improperly connected grounding conductors may cause electric shock.

Water supply

A proper water pressure for this washing machine is between 50 kPa and 800 kPa. Water pressure less than 50 kPa may cause the water valve to not close completely, or it may take longer to fill the drum, causing the washing machine to turn off. Water taps must be within 120 cm from the rear of the washing machine so that the provided inlet hoses reach the washing machine.

To reduce the risk of leaks:

- Make sure water taps are easily accessible.
- Turn off the taps when the washing machine is not in use.
- Check for any leaks at the water inlet hose fittings on a regular basis.

CAUTION *Before using the washing machine for the first time, check all connections at the water valve and taps for any leaks.*

Drain

Samsung recommends a standpipe 60-90 cm high. The drain hose must be connected through the hose clip to the standpipe, and the standpipe must fully cover the drain hose.

Flooring

For best performance, the washing machine must be installed on a solid floor. Wood floors may need to be reinforced to minimise vibration and/or unbalanced loads. Carpeting and soft tile surfaces do not resist vibration well and may cause the washing machine to move slightly during the spin cycle.

CAUTION

Do NOT install the washing machine on a platform or a poorly supported structure.

Water temperature

Do not install the washing machine in areas where water may freeze as the washing machine always retains some water in its water valves, pumps, and/ or hoses. Frozen water left in the connection parts may cause damage to belts, the pump, and other components of the washing machine.

Alcove installation

Minimum clearance for stable operation:

Minimum clearance for stable operation.

Sides	25 mm
Top	25 mm
Rear	50 mm
Front	550 mm

If both the washing machine and a dryer are installed in the same location, the front of the alcove must have at least a 550 mm unobstructed air opening. Your washing machine alone does not require a specific air opening.

Step-by-step installation

STEP 1 Select a location

Location requirements:

- Solid, level surface without carpeting or flooring that may obstruct ventilation
- Away from direct sunlight
- Adequate room for ventilation and wiring
- The ambient temperature is always higher than the freezing point (0 °C)
- Away from a heat source

NOTE

- To prevent excessive vibration while operating the washing machine, consider stability before anything else.
- Install your washing machine on a solid and level floor.
- Do not install your washing machine on soft floors or floor coverings.
- If you install your washing machine on a wood floor, install a water-resistance wooden panel (min 1.18 in. / 30 mm thick) to the floor. Also, we recommend installing your washing machine on the corner of the wood floor.

STEP 2 Remove the shipping bolts

Unpack the product package and remove all shipping bolts.

NOTE

Number of shipping bolts may differ depending on the model.

WARNING

- Packaging materials can be dangerous to children. Dispose all packaging material (plastic bags, polystyrene, etc.) out of children's reach.

- To avoid injury, cover the holes with bolt caps after removing the shipping bolts. Do not move the washing machine without the shipping bolts in place. Assemble the shipping bolts before moving the washing machine to another location. Keep the shipping bolts in a safe place for future use.

1. Locate the shipping bolts (marked with circle in the figure) on the rear side of the washing machine.

- **CAUTION** Do not remove the screw (A) that fixes the hose clip.

2. Using the supplied spanner, loosen all the shipping bolts by turning them anticlockwise.

- **NOTE** You must keep the shipping bolts for future use.

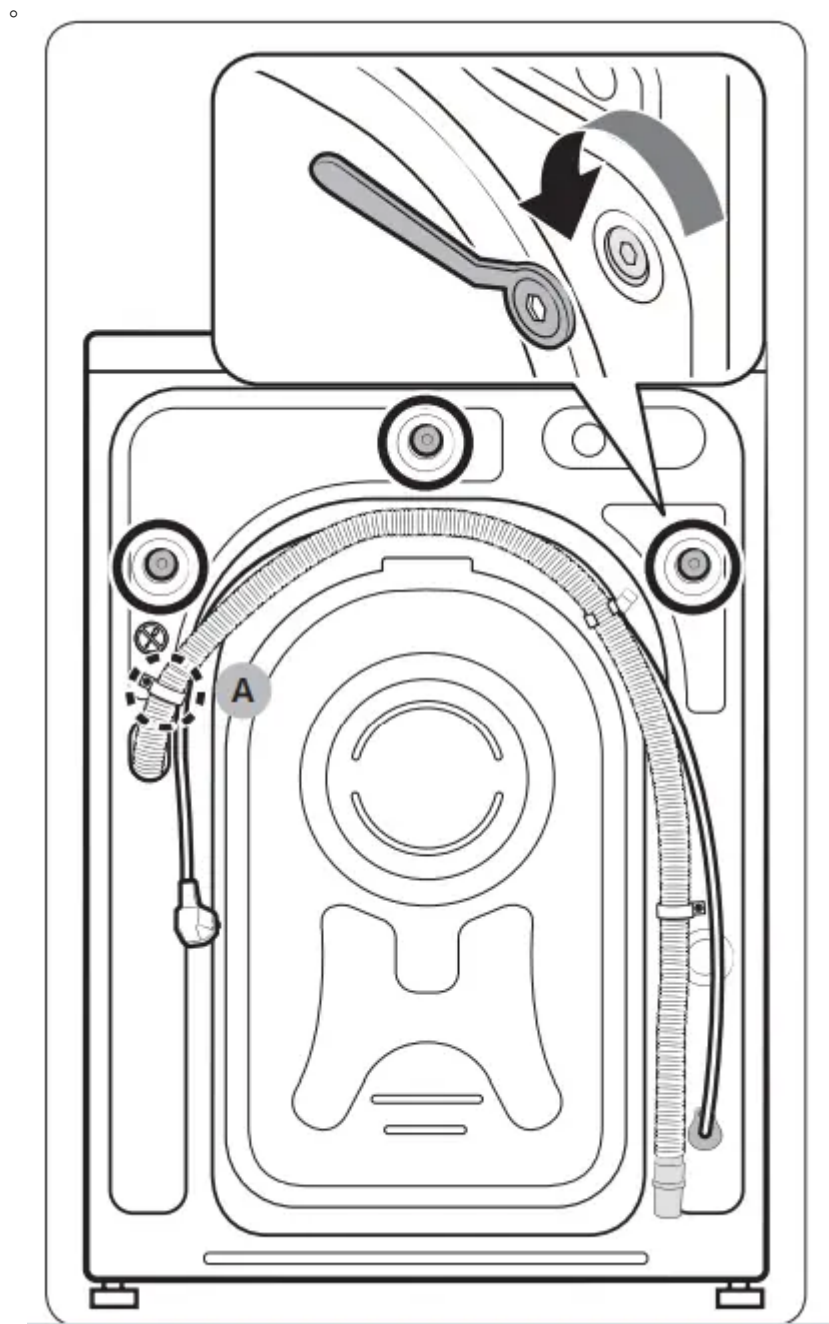

3. Insert the bolt caps (B) to the holes (marked with circle in the figure).

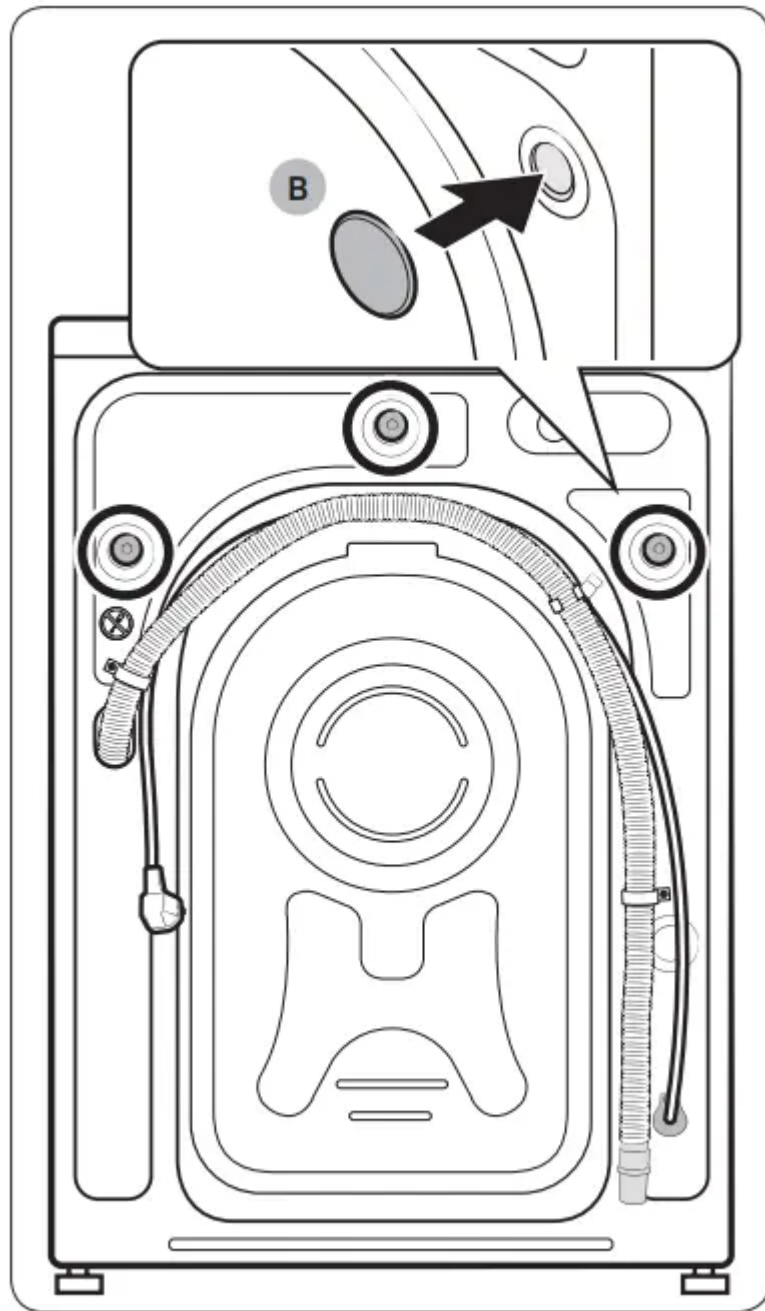

STEP 3 Adjust the levelling feet



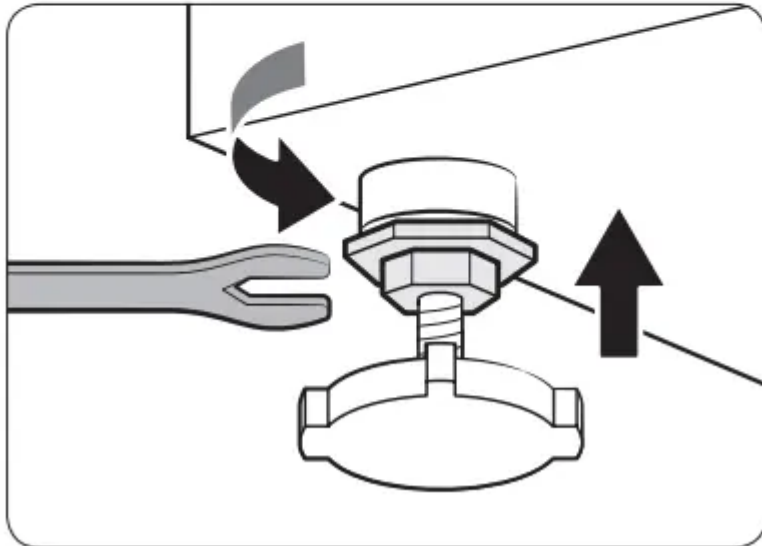
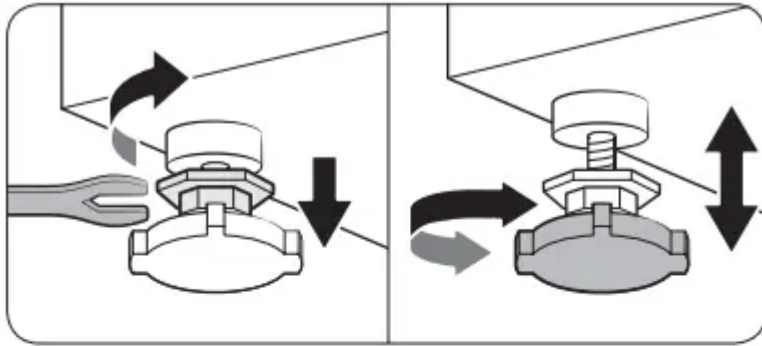

1. Gently slide the washing machine into position. Excessive force may damage the levelling feet.
2. Level the washing machine by manually adjusting the levelling feet.
3. When levelling is complete, tighten the nuts using the spanner.

CAUTION When installing the product make sure the levelling feet is not pressing the power cord.

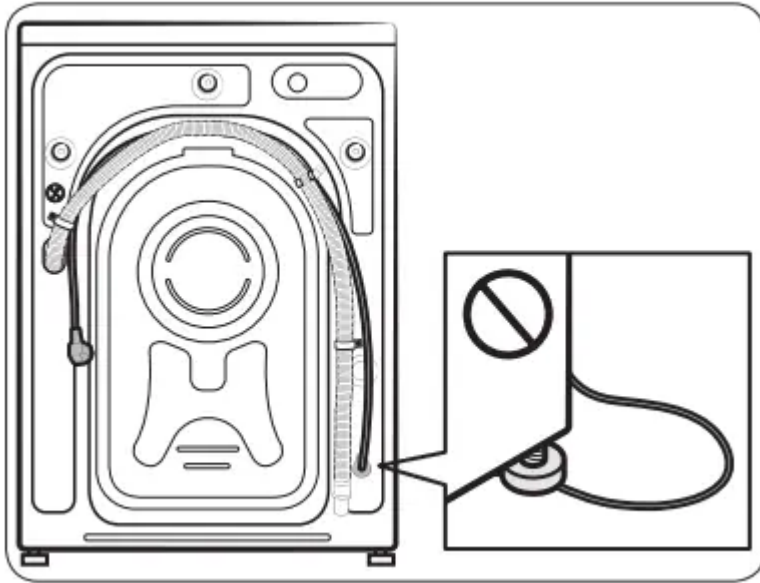

CAUTION Make sure all the levelling feet are seating on the floor surface to avoid the washing machine from moving or generating noise due to vibration. Then, check if the washing machine is rocking. If the washing machine is not rocking, tighten the nuts.

STEP 4 Connect the water hose

The provided water hose may differ depending on the model. Please follow the instruction according to the provided water hose.

Connecting to a threaded water tap

1. Connect the water hose to the water tap, and then turn it to the right to tighten.

CAUTION Before connecting the water hose, make sure there is a rubber washer in the hose connector. Do not use the hose if the washer is damaged or missing.

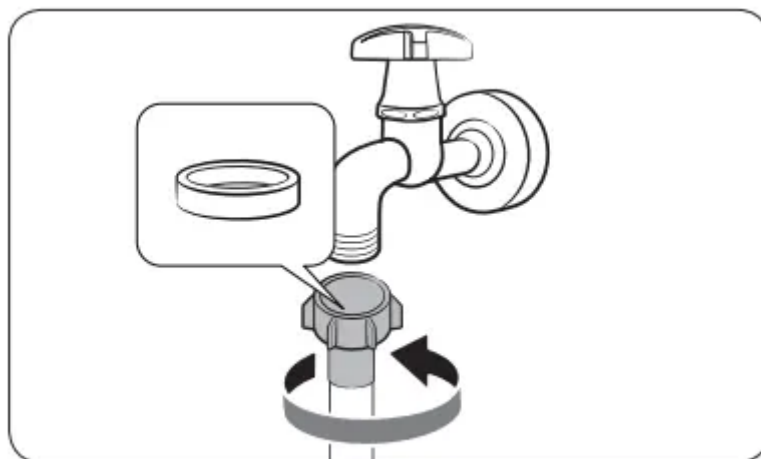

2. Connect the other end of the water hose to the inlet valve on the back of the washing machine, and then turn it to the right to tighten.

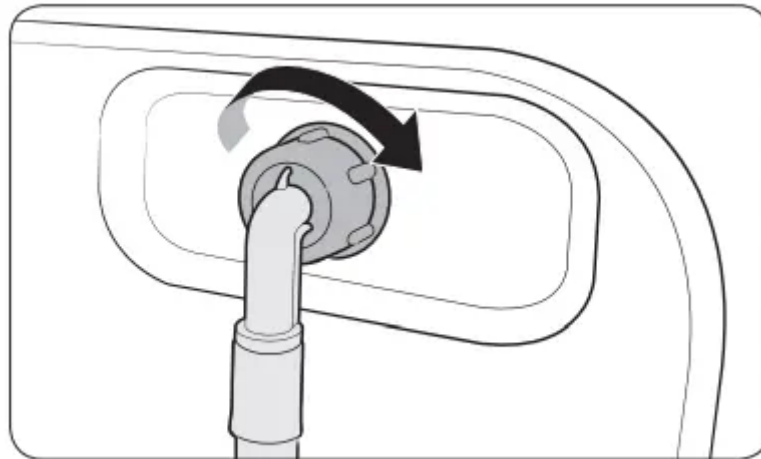

3. Slowly open the water tap and check if there are any leaks around the connection areas. If there are water leaks, repeat step 1 and 2.

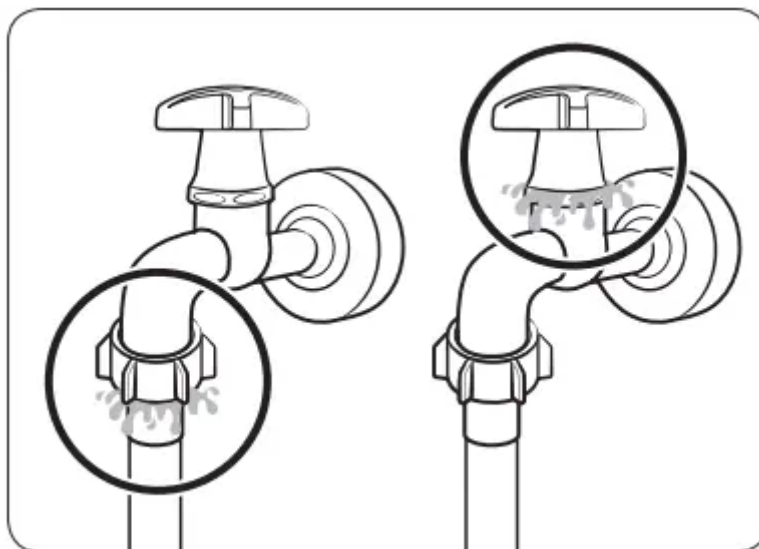

WARNING

If there is a water leak, stop operating the washing machine and disconnect it from the electrical supply. Then, contact a local Samsung service centre in case of a leak from the water hose, or contact a plumbing technician in case of a leak from the water tap. Otherwise, this may cause electric shock.

CAUTION

Do not stretch the water hose by force. If the hose is too short, replace the hose with a longer, high-pressure hose.

Connecting to a non-threaded water tap

1. Remove the adaptor (A) from the water hose (B).

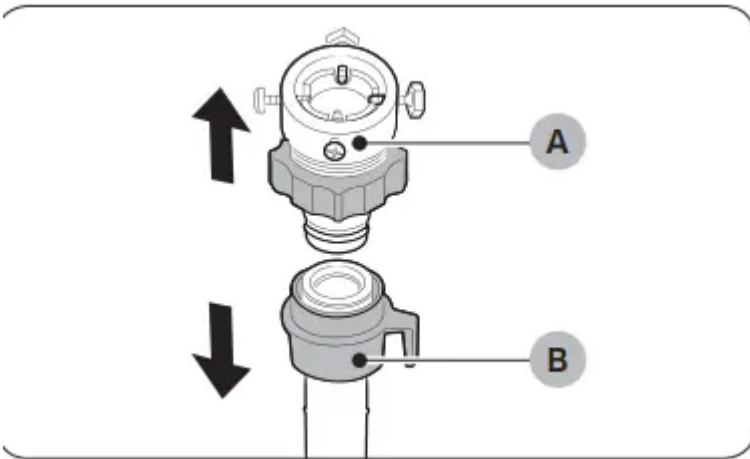

2. Use a Phillips screwdriver to loosen four screws on the adaptor.

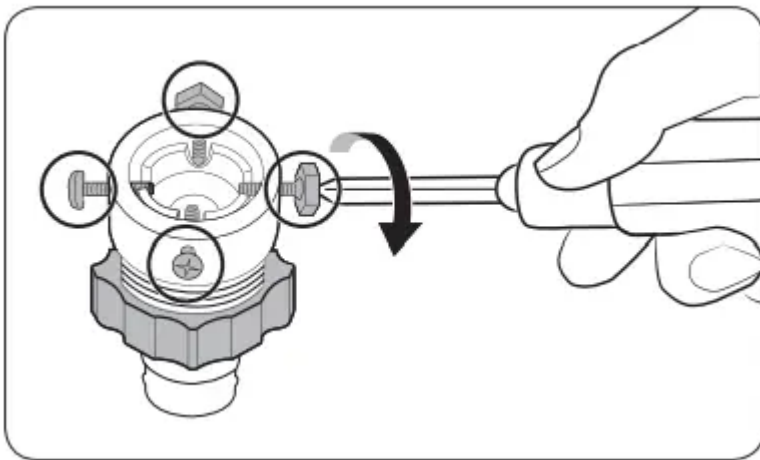

3. Hold the adaptor and turn part (C) in the arrow direction to loosen it by 5 mm (*).

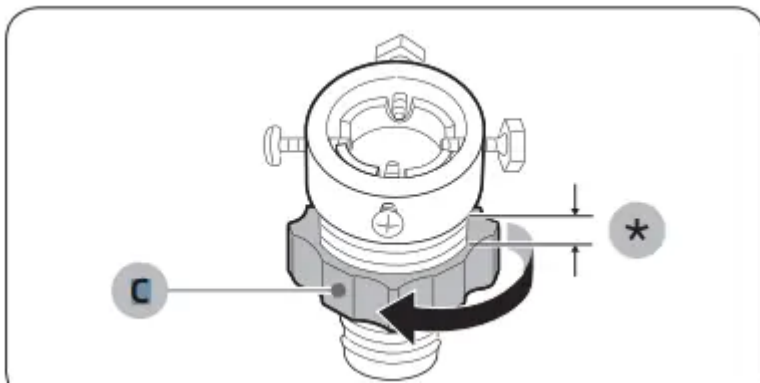

4. Insert the adaptor onto the water tap, and then tighten the screws while lifting the adaptor.

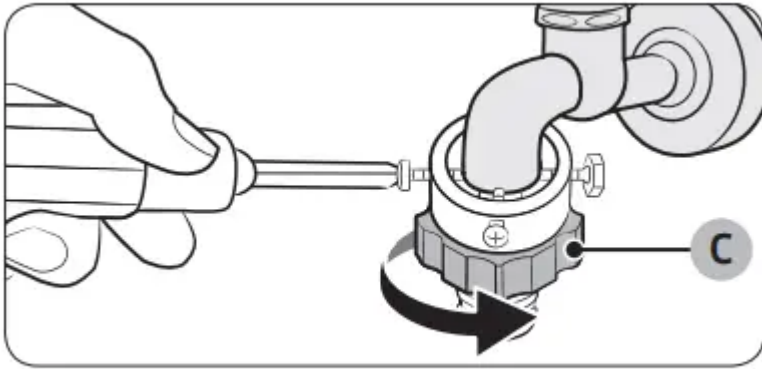

5. Turn part (C) in the arrow direction to tighten it.

6. While pulling down part (D) on the water hose, connect the water hose to the adaptor. Then, release part (D). The hose fits into the adaptor with a clicking sound.

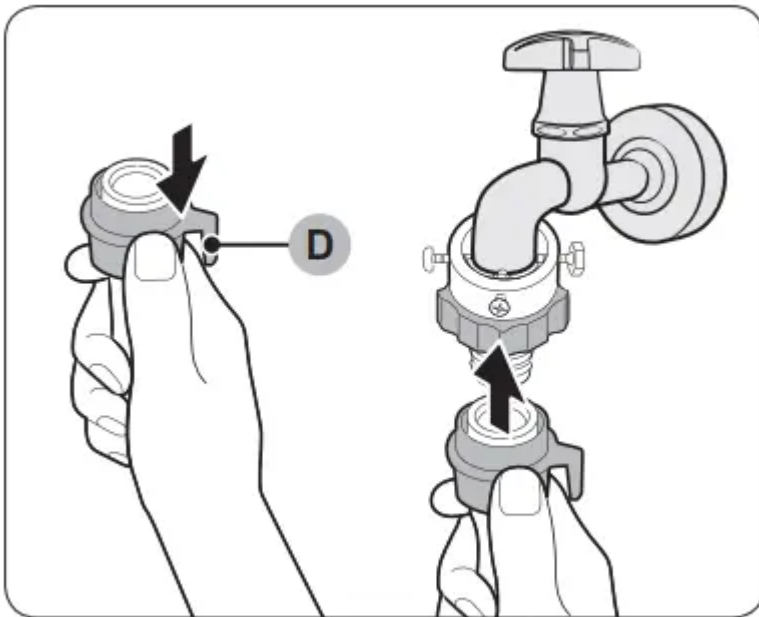

7. To complete connecting the water hose, see 2 and 3 on the “Connecting to a threaded water tap” section.

NOTE

- After connecting the water hose to the adaptor, pull the water hose down to check if it is connected properly.
- Use a popular type of water taps. If the tap is square-shaped or too big, remove the spacer ring before inserting the tap into the adaptor.

For models with an additional hot water inlet:

1. Connect the red end of the hot water hose to the hot water inlet on the back of the machine.
2. Connect the other end of the hot water hose to the hot water tap.

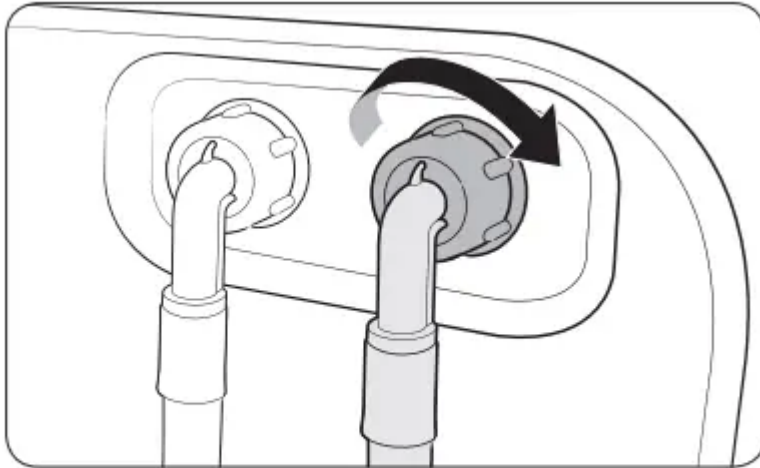

Aqua stop hose (applicable models only)

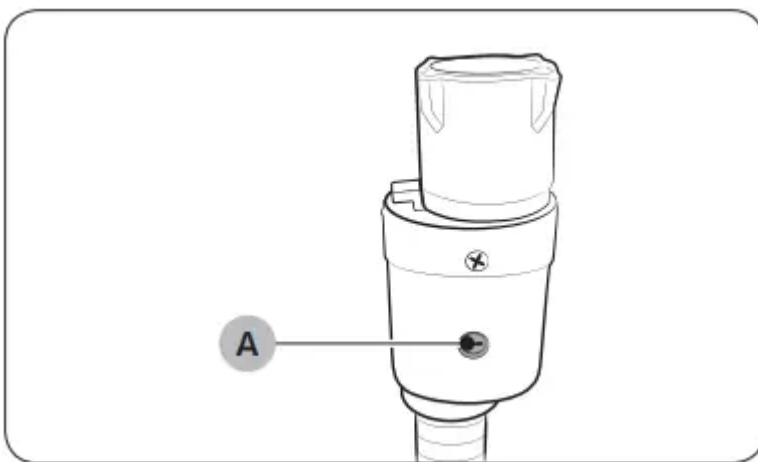

The aqua stop hose alerts users of a risk of water leaks. It senses the water flow and turns red on the centre indicator (A) in case of a leak.

NOTE The end of the aqua stop hose must be fitted to the water tap and not the machine

STEP 5 Position the drain hose

The drain hose can be positioned in three ways:

Over the edge of a wash basin

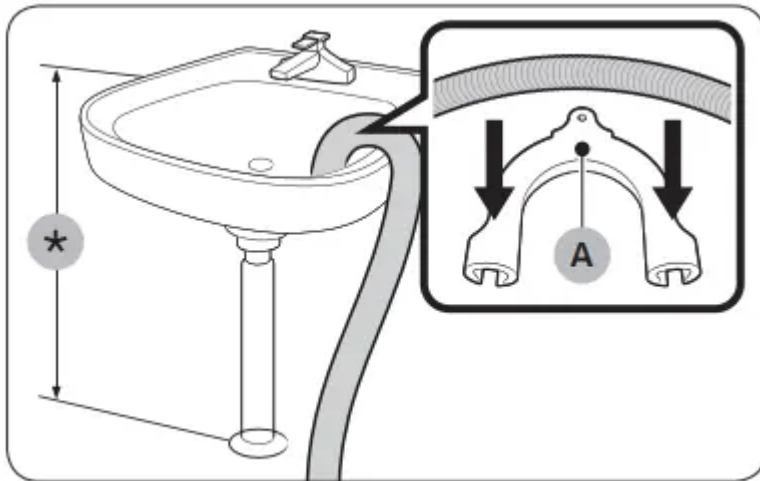

The drain hose must be placed between 60 cm and 90 cm (*) above from the floor. To keep the spout of the drain hose bent, use the supplied plastic hose guide (A). Secure the guide to the wall using a hook to ensure stable drainage.

In a drain pipe

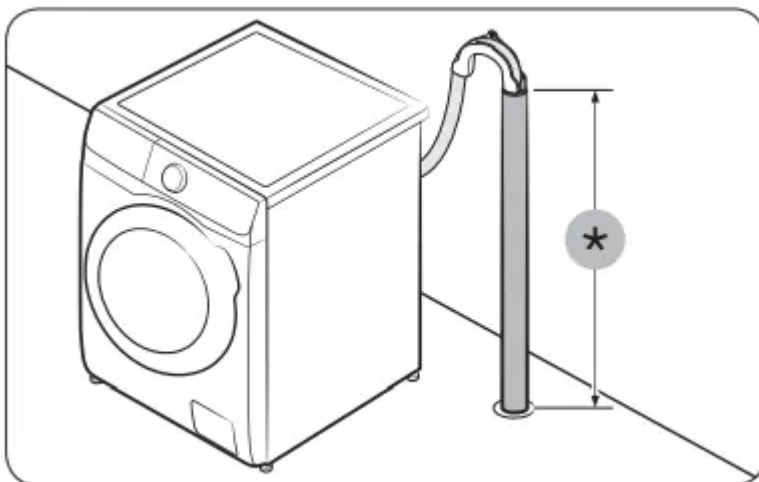

The drain pipe should be between 60 cm and 90 cm high (*). It is advisable to use a 65 cm high vertical pipe.

- To ensure the drain hose stays in position, use the plastic hose guide provided (see the figure).
- To prevent the siphoning of water flow during drainage, make sure to insert the drain hose 15 cm in the drain pipe.
- To prevent the drain hose from moving around, secure the hose guide to the wall.

Drain standpipe requirements:

- Minimum diameter of 5 cm
- Minimum carry-away capacity of 60 litres per minute

In a sink drain pipe branch

The drain pipe branch must be above the sink siphon so that the end of the hose is at least 60 cm above the ground.

(*) : 60 cm

CAUTION Remove the lid on the sink drain pipe branch before connecting the drain pipe to it.

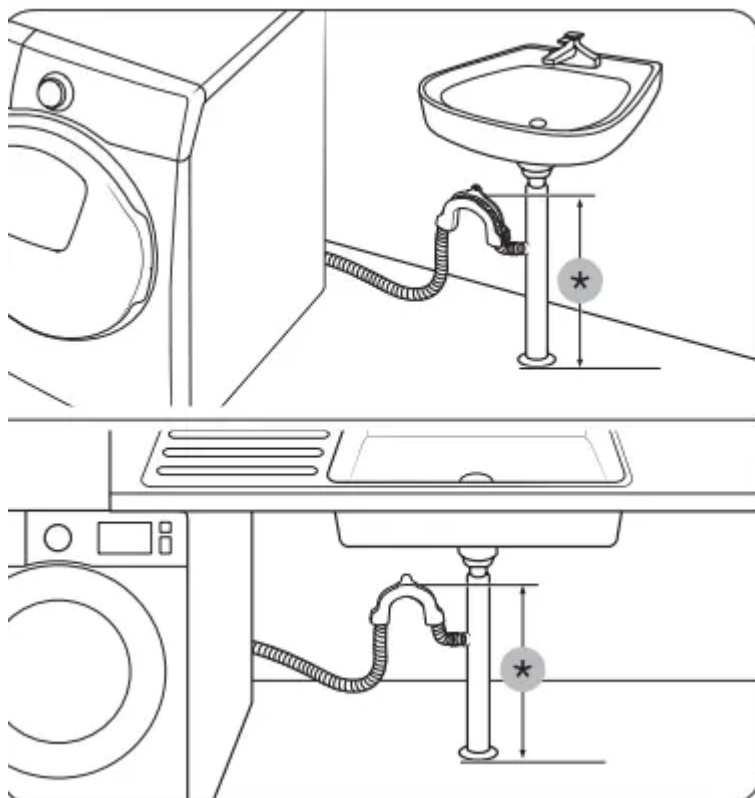

CAUTION Do not put the drain hose in places of stagnant water or ponding. The water may flow back to the washing machine.



STEP 6 Power on

Plug the power cord into a wall socket featuring an AC 220-240 V / 50 Hz approved electrical outlet protected by a fuse or circuit breaker. Then, tap  to turn on the washing machine

Before you start



Initial setup

- When you turn on the washing machine for the first time, the screen shows the initial setup process. Follow the on-screen instructions to complete it.
- Initial setup will not repeat after you've completed it.
- The initial setup includes language selection, calibration, and a brief tutorial.
- Tap  or turn the Navigation dial to skip to the next screen.

Run Calibration

- Initial setup includes the calibration process which comes after the language selection. You must proceed calibration before using the washing machine.
- Empty the drum, and then tap and hold to start calibration.
- When calibration is complete, power turns off and then turns on automatically.

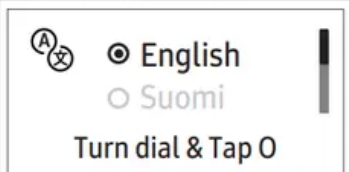
- If you want to proceed calibration again, tap and hold for 3 seconds to enter the system function and select Calibration.

01 Language selection 	02 Calibration <p>Empty drum before calibrating</p> <p>[Tap 0 to skip]</p>	03 Welcome screen <p>Welcome!</p>
04 Tutorial		
<p>Let's explore your new washer!</p> <p>[Tap 0 to skip]</p>	<p>Washer that knows me All Done!</p> <p>[Tap 0 to skip]</p>	 <p>Great!</p>

Laundry guidelines

STEP 1 Sort

Sort the laundry according to these criteria:

- Care Label: Sort the laundry into cottons, mixed fibres, synthetics, silks, wools, and rayon.
- colour: Separate whites from colours.
- Size: Mixing different sized items together in the drum improves the washing performance.
- Sensitivity: Wash delicate items separately using an Easy Iron option for pure, new woollen items, curtains, and silk items. Check the labels on the items.

NOTE Make sure to check the care label on the clothing, and sort them accordingly before starting the wash

STEP 2 Empty pockets

Empty all the pockets of your laundry items

- Metal objects such as coins, pins, and buckles on clothing may damage other laundry items as well as the drum.

Turn clothing with buttons and embroideries inside out

- If trousers or jacket zippers are open while washing, the drum may be damaged. Zippers should be closed and fixed with a string.
- Clothing with long strings may become entangled with other clothes. Make sure to tie the strings before starting the wash.

STEP 3 Use a laundry net

- Brassieres (machine washable) must be placed in a laundry net. Metal parts of the brassieres may break through and tear other laundry items.
- Small, light clothing such as socks, gloves, stockings, and handkerchiefs may become caught around the door. Place them inside a fine laundry net.
- Do not wash the laundry net by itself without other laundry. This may cause abnormal vibrations that could move the washing machine and result in injury.

STEP 4 Prewash (if necessary)

Select the Prewash option for the selected cycle if the laundry is heavily soiled. Do not use the Prewash option when detergent is manually added into the drum.

STEP 5 Determine the load capacity

Do not overload the washing machine. Overloading may cause the washing machine to not wash properly. For the load capacity for the type of clothing, see page 38.

NOTE *When washing bedding or bedding covers, the wash time may be lengthened or the spin efficiency may be reduced. For bedding or bedding covers, the recommended maximum spin cycle speed is 800 rpm, and the load capacity is 2.0 kg or less.*

CAUTION

- Unbalanced laundry may reduce the spinning performance.
- Make sure the laundry is fully inserted in the drum and not caught in the door.
- Do not slam the door. Close the door gently. Otherwise, the door may not be closed properly.

STEP 6 Apply a proper detergent type

The type of detergent depends on the type of fabric (cotton, synthetic, delicate items, wool), colour, wash temperature, and degree of soiling. Make sure to use the laundry detergent that is designed for automatic washing machines.

NOTE

- Follow the detergent manufacturer's recommendations based on the weight of the laundry, the degree of soiling, and the hardness of the water in your local area. If you are not sure about the water hardness, contact a local water authority.
- Do not use detergent that tends to be hardened or solidified. This detergent may remain after the rinse cycle, blocking the drain outlet.

CAUTION *When washing wool using the Wool cycle, use a detergent dedicated to wool items. If used with the Wool cycle, powder detergent may remain on the laundry and discolour the laundry.*

Laundry capsules

To get the best results from using laundry capsules, please follow these instructions.

1. Put the capsule in the bottom of the empty drum towards the rear.

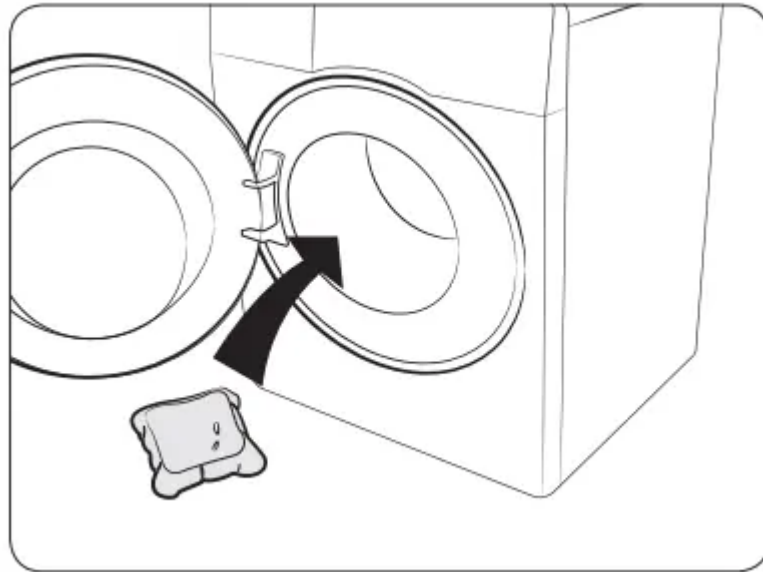

2. Put the laundry in the drum on top of the capsule.

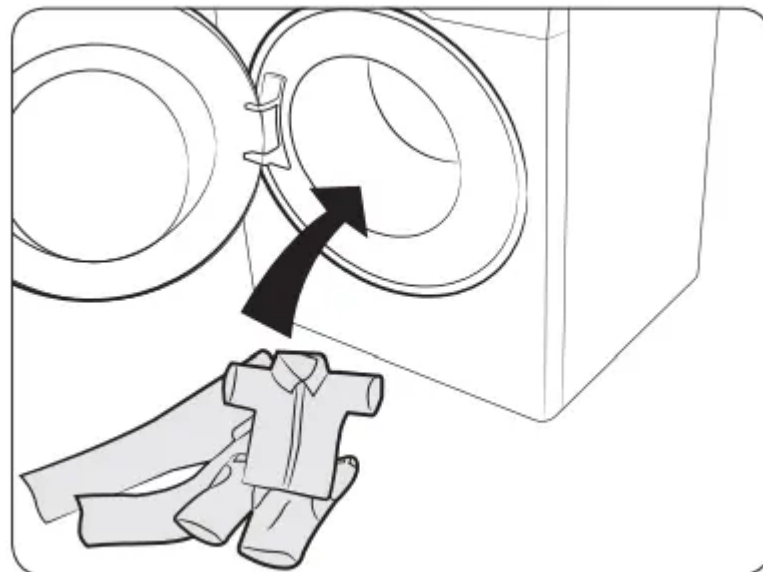

CAUTION For cycles using cold water or cycles that complete in less than one hour, the capsule may not dissolve completely.

Detergent recommendation



The recommendations apply to the temperature ranges given in the cycle chart.

●	Recommended	▲	Liquid detergent only
-	Not recommended	△	Powder detergent only

Cycle	Detergent		
	Universal	Delicates and woollens	Specialist
Eco 40-60	●	-	-
Cotton	●	-	-
AI Wash (WW**T98****, WW**T93**** models only)	●	-	-
15' Quick Wash	●	-	-
Super Speed (WW**T9****, WW**T8****, WW**T7****, WW**T6**** models only)	●	-	-
Intense Cold	●	-	-
Wool	-	▲	▲
Bedding	●	-	-
Outdoor	●	-	-
Shirts	●	-	-
Towels	●	-	-
Hygiene Steam	●	-	-
Baby Care	●	-	-
Rinse+Spin	●	-	-
Drain/Spin	●	-	-
Cloudy Day	●	-	-
Activewear	●	-	-
Colours	●	-	-
Synthetics	●	-	-
Delicates	WW**T9****, WW**T5****	-	-
	WW**T8****, WW**T7****, WW**T6****	▲	▲
Denim	●	-	-
Silent Wash	●	-	-
Mixed Load (WW**T5**** model only)	●	-	-

Detergent drawer guidelines

The automatic dispenser models provide a three-compartment dispenser: two compartments for autodispensing and another part for manual input. With the automatic dispensing option on, the washing machine dispenses an adequate amount of detergent or fabric softener for each load. See below for details:

- A. Auto detergent compartment 
 - Use liquid detergent only.
- B. Auto softener compartment 
 - Use fabric softener only.

- C. Manual detergent compartment 

- If necessary, add detergent manually as instructed by the detergent manufacturer.
- To use the detergent in this compartment, make sure the auto-dispensing option is off. (For more information on turning the autodispensing off, see the “Dose per Wash” and “Dose per Rinse” section on page 42.
- Do not exceed the max line (D) when adding detergent.

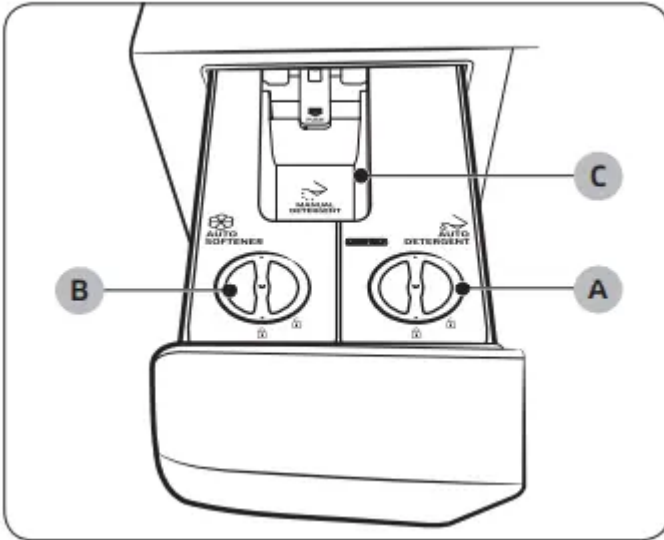

CAUTION

- Do not add an excessive amount of detergent. This may affect the washing results adversely.
- Do not use any cleaning agents for cleaning the drum. Chemical residue in the drum deteriorates the washing performance.

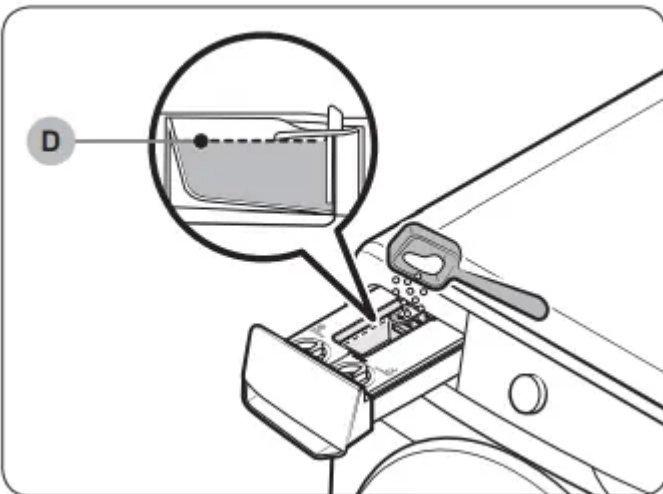

CAUTION

- Do not operate the washing machine with the compartments not placed in the detergent drawer.
 - A water leak may cause electric shock or injury.
- Do not use the following types of detergent in the drawer.
 - Tablet, capsule, ball, or net types.
- Do not use gel-type or viscous detergent/softener in the detergent drawer as they may not flow well.
 - Read the detergent/softener manufacturer's instructions before using them in the washing machine.
- Do not carry any removed compartment. Put the compartment back in place.
 - Otherwise, the compartment may shake and cause the content to spill out.
- Empty the compartments in the detergent drawer before moving the washing machine to prevent any content from spilling out on the floor.

NOTE

- The "Detergent drawer is open" message appears if the detergent drawer is not completely closed. Close the detergent drawer before you start the washing machine.
- If message "Refill detergent", "Refill softener", or "Refill detergent & softener" appears on the display, refill the corresponding compartment.
- Detergent/softener is not automatically dispensed in the Wool cycle. To dispense detergent/softener in the Wool cycle, you must manually set the input level of detergent/softener.
- Do not exceed the max line when filling detergent and softener.
- For special detergent or softener (for wool, baby clothes, etc.), purchase additional compartments and use the new compartments exclusively for the special detergent or softener.
- It may be hard to open the detergent drawer with just your fingertips. Grab the detergent drawer handle firmly with your hand and pull to open it.
- Push the detergent drawer all the way to the end to close it. You will hear a click sound when the drawer is properly closed.
- If the you feel softener scent is weak, set the softener input level to High.

To apply washing agents to the auto dispenser

NOTE

- If message "Refill detergent", "Refill softener", or "Refill detergent & softener" appears on the display, refill the corresponding compartment.
- Once you refill the auto detergent/softener compartments, the washing machine will start to detect the detergent/softener amount when you tap and hold .
- The detection time may vary depending on the type of the detergent/softener.

1. Pull the detergent drawer to open.

2. Turn the auto detergent compartment cover (A) anticlockwise to open.

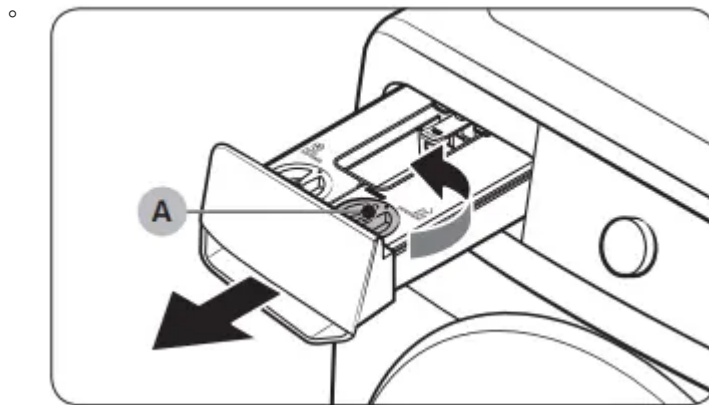

3. Apply an appropriate amount of detergent to the auto detergent compartment (B).

- After you finish, put the cover back and turn it clockwise to close.

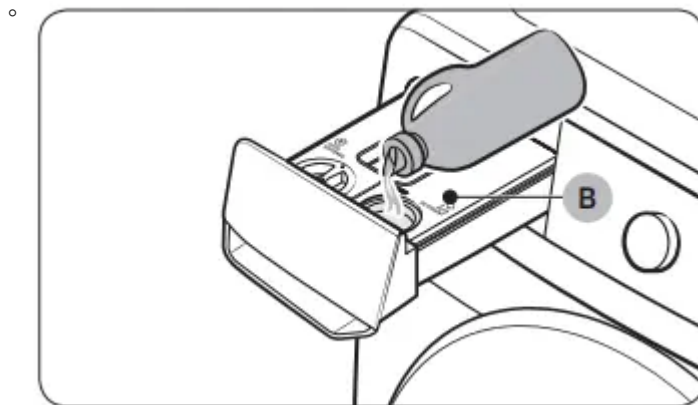

4. Turn the auto softener compartment cover (C) anticlockwise to open.

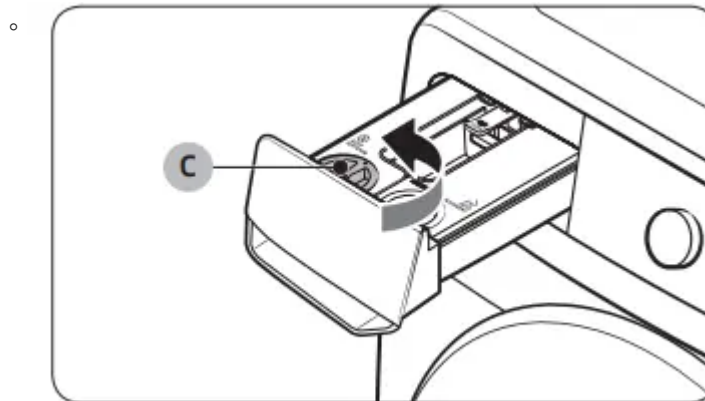

5. Apply an appropriate amount of softener to the auto softener compartment (D).

- After you finish, put the cover back and turn it clockwise to close.

6. Push the detergent drawer to close.

- Push the detergent drawer all the way to the end. You will hear a click sound when the drawer is properly closed.

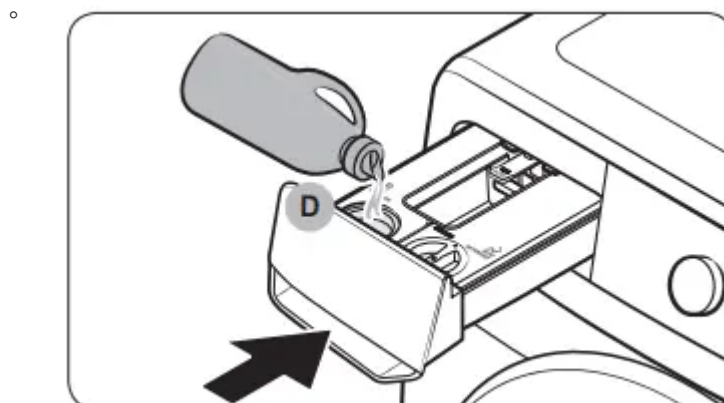

CAUTION

- Do not apply detergent/softener to the drawer without the detergent/softener compartment.
 - If you do, clean the drawer and then reinsert both compartments.
- Use only liquid detergent/softener with the detergent/softener compartments. Do not use powdered detergent.
- Make sure both detergent/softener compartments are inserted completely.
 - If they are not, the washing machine may not start operating or fail to dispense washing agents.
- Clean the detergent/softener compartment before refilling them with the same or a different type of detergent or softener.

- Do not leave detergent/softener in the detergent/softener compartments for more than 6 weeks.
- Do not mix detergent with fabric softener in either compartment.
- To prevent detergent/softener from hardening, do not open the cover once the detergent/softener has been applied to the compartment.
- Do not use any bleach that may cause corrosion and/or generate the gas.
- Do not turn any compartment upside down.
 - The content may spill.
- Do not press the outlet at the rear of either compartment while moving it.
 - The content may leak.
- Use caution when inputting detergent or fabric softener in the applicable compartment.
 - The content may spill.
- When removing the detergent/softener compartment to check the remaining content (upon an error message or before the message appears), the drawer may have content remaining or leaking from the bottom of the drawer.
- Make sure all the compartments in the detergent drawer are empty before moving the washing machine.
- The input or refill level of the detergent/softener depends on the type or the remaining amount of detergent/softener.
- If you see the "Refill detergent", "Refill softener", or "Refill detergent & softener" message on the display, immediately refill the corresponding compartment. A later refill may cause the input level of the agent to decrease.
- Applying detergent directly on laundry cause discoloration. Apply detergent in the detergent compartment.
- Do not use hardened detergent/softener.

NOTE



- Moisture on powder detergent compartment causes the powdered detergent to stick. Therefore, wipe the moisture with dry cloth before adding the powdered detergent.
- Use detergent and bleach for washing machine only.
- Do not use gel-type or viscous detergent/softener in the detergent drawer as they may not flow well.
 - Read the detergent/softener manufacturer's instructions before using them in the washing machine.

Operations

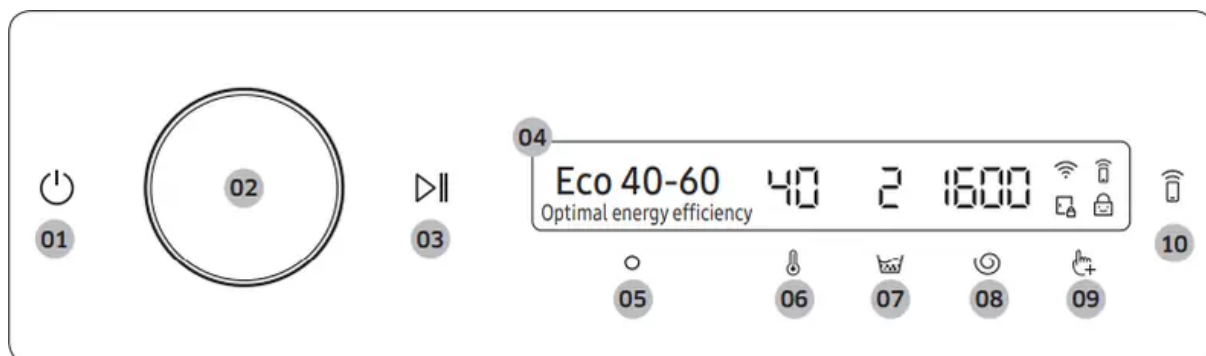
Control panel



1. Power

- Tap to turn the washing machine on or off.
 - If you do not manipulate the control panel for 10 minutes after the washing machine is turned on, the washing machine automatically turns off.
 - The washing machine automatically turns off when the cycle completes.
- **CAUTION** Do not tap  to turn the washing machine off while the wash cycle is in progress. Tap and  hold to pause the cycle first, and then tap  to turn the washing machine off.

2. Navigation dial

- Turn the navigation dial left or right to navigate through cycles and functions. When you turn the navigation dial, LCD displays your selection (such as cycle, additional functions, and system functions).

3. Start/Pause

- Tap and hold to start or pause an operation.

4. Display

- The display shows current cycle information and estimated time remaining, or an information message when a problem occurs.

5. OK

- Tap to confirm your selection of function or setting

6. Temp 

- Tap to change the water temperature for the selected cycle.
 - The indicator above the button indicates the default or selected setting.

7. Rinse 

- Tap to change the rinse count for the selected cycle.
 - The indicator above the button indicates the default or selected setting.

8. Spin 

- Tap to change the spin speed for the selected cycle.
 - The indicator above the button indicates the default or selected setting.

9. Additional function 

- Tap to enter the additional functions menu. Tap and hold for 3 seconds to enter the system functions menu.

10. Smart Control 

- Tap to activate or deactivate the Smart Control function. Tap and hold to enter pairing mode to connect to the SmartThings app.
- When the Smart Control function is activated, you can control your washing machine remotely using the SmartThings app on your smartphone or tablet (Android or iOS).

Icon descriptions

1.  Wi-Fi

- This icon indicates that the washing machine is connected to Wi-Fi.

2.  Smart Control

- This icon indicates that Smart Control is on.
- For more information on Smart Control, see page 47.

3.  Door Lock

- This icon indicates the door is locked and cannot be opened.

- The door locks automatically during a cycle and this indicator turns on.
- You can open the door when this icon disappears.

4.



Child Lock

- This icon indicates that Child Lock is on.
- For more information on Child Lock, see page 43

Operating a cycle

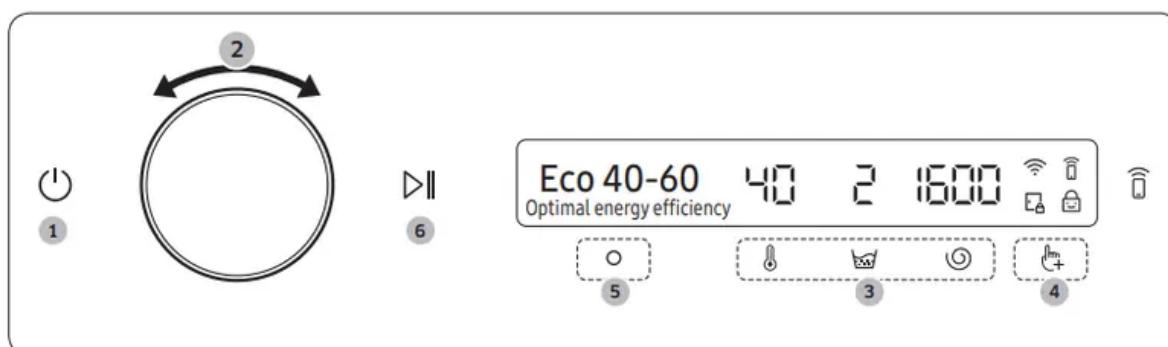

1. Tap turn on the washing machine.
2. Turn the Navigation dial to select the cycle you want.
 - For more information on Cycle overview, see page 38.
3. Tap , , or to change the default cycle settings.
4. Tap , and then turn the Navigation dial to select additional function.
 - For more information on Additional functions, see page 41.
5. Tap to change the settings for selected additional function.
 - Not all cycles have additional functions available.
6. Tap and hold to start operation.
 - Once you set the cycle you want, the screen displays a brief cycle description, maximum laundry load, and cycle time. You can also check the cycle progress, remaining cycle time, and information codes.

Cycle overview

Cycle	Description	Max load (kg)
		9 / 8 / 7 kg
Eco 40-60	<ul style="list-style-type: none"> For cleaning normally soiled cotton items which are declared to be washable at 40 °C or 60 °C, together in the same cycle. This cycle is used to assess the compliance with the EU Ecodesign legislation. This cycle is set as a default. 	Max
Cotton	<ul style="list-style-type: none"> For cottons, bed linens, table linens, underwear, towels, or shirts. The washing time and the rinse count are automatically adjusted according to the load. For cleaning lightly soiled cotton items at a nominal temperature of 20 °C. 	Max
AI Wash (WW**T98****, WW**T93**** models only)	<ul style="list-style-type: none"> Adjusts the amount of detergent and the cycle according to the load and the soil severity. This cycle is best used with the Auto Dispense function. 	Max
15' Quick Wash	<p>For lightly soiled items in less than 2.0 kg that you want to wash quickly.</p> <ul style="list-style-type: none"> Use less than 20 g of detergent. Using more than 20 g of detergent may leave detergent residue. For liquid detergent, use a max of 20 ml of liquid detergent. 	2
Super Speed (WW**T9*****, WW**T8*****, WW**T7*****, WW**T6***** models only)	<ul style="list-style-type: none"> Fast completion within 39 minutes for everyday items such as underwear and shirts. The cycle time will differ depending on the water supply conditions, load, and type of laundry. 	5
Intense Cold	<ul style="list-style-type: none"> Low temperature ecobubble cycle helps reduce power consumption. 	4
Wool	<ul style="list-style-type: none"> Specific for machine-washable wool for loads less than 2.0 kg. The Wool cycle features fine pulsating and soaking to protect the wool fibres from shrinkage/distortion. A neutral detergent is recommended. 	2
Bedding	<ul style="list-style-type: none"> For bed spreads, bed sheets, bedding covers, etc. For best results, wash only 1 type of bedding and make sure the load weighs less than 2.0 kg. 	2

Cycle	Description	Max load (kg)
		9 / 8 / 7 kg
Outdoor	<ul style="list-style-type: none"> For outdoor clothes, skiwear, and sportswear that are made of functional materials such as spandex, stretch, and micro-fibre. 	2
Shirts	<ul style="list-style-type: none"> For shirts, blouses that are made of cotton, synthetic fiber. 	2
Towels	<ul style="list-style-type: none"> For bath towels, washcloths, and mats. 	4
Hygiene Steam	<ul style="list-style-type: none"> Cotton and linen fabric which have been in direct contact with the skin, such as underwear. For optimum hygiene results select a temperature of 60 °C or above. Steam cycles feature allergy care and bacteria elimination (sterilize). 	4
Baby Care	<ul style="list-style-type: none"> Featuring a high-temperature wash and extra rinses to help remove the remaining detergent effectively. 	4
Rinse+Spin	<ul style="list-style-type: none"> Featuring an additional rinse process after applying fabric softener to the laundry. 	Max
Drain/Spin	<ul style="list-style-type: none"> For draining the water inside the drum and running an additional spin process to effectively remove moisture from laundry. 	Max

Drum Clean+ (WW**T9*****, WW**T8*****, WW**T7*****, WW**T6***** models only)	<ul style="list-style-type: none"> Cleans the drum by removing dirt and bacteria from it. Cleans the rubber door gasket by removing dirt from the gasket. Perform once every 40 washes with no detergent or bleach applied. Notification message appears after every 40 washes. Make sure the drum is empty. Do not use any cleaning agents for cleaning the drum. 	-
Drum Clean (WW**T5***** model only)	<ul style="list-style-type: none"> Cleans the drum by removing dirt and bacteria from it. Perform once every 40 washes with no detergent or bleach applied. Notification message appears after every 40 washes. Make sure the drum is empty. Do not use any cleaning agents for cleaning the drum. 	-
Cloudy Day	<ul style="list-style-type: none"> For optimum spin drying at high humid condition. 	Max

Cycle	Description	Max load (kg)
		9 / 8 / 7 kg
Activewear	<ul style="list-style-type: none"> For exercise wear such as sports jerseys, training pants, shirts/tops and other performance clothing. This cycle provides effective soil removal with controlled drum rotation for special fabric care. 	2
Colours	<ul style="list-style-type: none"> Featuring additional rinses and reduced spinning to ensure that the laundry is washed gently and rinsed thoroughly. 	4
Synthetics	<ul style="list-style-type: none"> For fabrics that are made of polyester (diolen, trevira), polyamide (perlon, nylon), or the like. 	4
		5*
Delicates	<ul style="list-style-type: none"> For sheer fabrics, bras, lingerie (silk), and other handwash-only fabrics. For best performance, use liquid detergent. 	2
Denim	<ul style="list-style-type: none"> Featuring a higher water level in the main wash and an extra rinse cycle to ensure that no powder detergent remains. 	3
Silent Wash	<ul style="list-style-type: none"> For reducing operating noise and vibration. 	4
Mixed Load (WW**T5***** model only)	<ul style="list-style-type: none"> For mixed load consisting of cotton and synthetic. 	4



*: WW**T7*6***, WW**T6*6*** models only

NOTE



- Loading the household washing machine or the household washer-dryer up to the capacity indicated by the manufacturer for the respective cycles will contribute to energy and water savings.
- The noise and remaining moisture content are influenced by the spinning speed: the higher the spinning speed in the spinning phase, the higher the noise and the lower the remaining moisture content.
- The most efficient cycle in terms of energy consumption are generally those that perform at lower temperatures and longer duration.

Additional functions

Using Additional Functions



1. Tap .
2. Turn the Navigation dial to select the desired additional function.
3. Tap  to change the selected function's settings or start the function.

NOTE

- To return to the main screen, tap  again or turn the Navigation dial to select Back and tap .
- If the selected function is not supported, the "This function is currently not supported" message is displayed, and the  button is not activated.
- When you select an additional function, a brief help message appears for the first ten times of use



Quick Drive (WW**T7***** model only)

You can reduce the overall washing time of the selected cycle settings.

1. Select a cycle and change the cycle settings as necessary.
2. Tap .
3. Turn the Navigation dial to select Quick Drive, and then tap .
4. Tap and hold .



Prewash

You can add a preliminary washing cycle before the main wash cycle.

1. Select a cycle and change the cycle settings as necessary.
2. Tap .
3. Turn the Navigation dial to select Prewash, and then tap .
4. Tap and hold .

Intensive



For badly soiled laundry. The operation time for each cycle is longer than normal.

1. Select a cycle and change the cycle settings as necessary.
2. Tap .
3. Turn the Navigation dial to select Intensive, and then tap .
4. Tap and hold .

Bubble Soak



This function helps remove a wide variety of stubborn stains. With Bubble Soak selected, laundry is thoroughly soaked in water bubbles for effective washing.

1. Select a cycle and change the cycle settings as necessary.
2. Tap .

3. Turn the Navigation dial to select Bubble Soak, and then tap 
 - Bubble Soak is available with and adds up to 30 minutes to these cycles: Cotton, Synthetics, Bedding, and Super Speed.
4. Tap and hold .



Dose per Wash

You can increase or decrease the amount of detergent dispensed automatically.

1. Tap .
2. Turn the Navigation dial to select Dose per Wash, and then tap .
3. Tap  to select the desired setting.
 - Default setting is Med. (Medium).
 - You can select from Med., High, Off, or Low.





Dose per Rinse

You can increase or decrease the amount of detergent dispensed automatically.

1. Tap .
2. Turn the Navigation dial to select Dose per Rinse, and then tap .
3. Tap  to select the desired setting.
 - Default setting is Med. (Medium).
 - You can select from Med., High, Off, or Low.

My Cycles

Add or remove cycles to create a personal cycle list.

1. Tap and hold  for 3 seconds.
2. Turn the Navigation dial to select My Cycles, and then tap 
 - You can only edit a cycle to create a personal cycle when the washing machine is not operating.
3. Turn the Navigation dial to select a desired cycle.
4. Tap  to add or remove the selected cycle.
 - Addition and removal of the course is saved automatically.
5. Once you finish creating My Cycles, tap  to return to the cycles screen.





NOTE

- The Eco 40-60 and Drum Clean+ cycles cannot be removed from the cycles list.



- You can also edit My Cycles in the SmartThings app.



Delay End



You can set the washing machine to finish your wash automatically at a later time, choosing a delay of between 1 to 24 hours (in 1 hour increments). The hour displayed indicates the time the wash will finish.

1. Select a cycle and change the cycle settings as necessary.
2. Tap .
3. Turn the Navigation dial to select Delay End, and then tap .
4. Turn the Navigation dial to select the desired time, and then tap .
5. Tap and hold .
 - Status shows in the display and the washing machine tumbles the drum to sense the weight of the load (if load sensing is preset for the selected cycle). When load sensing is complete, the display shows the remaining time until the end of the wash cycle.
 - To cancel Delay End, tap  to restart the washing machine.



Child Lock

To prevent children or infants from accidentally starting or setting the washing machine, Child Lock locks all buttons except for  and .

1. Tap .
2. Turn the Navigation dial to select Child Lock, and then tap .
3. Tap  to select On or Off.



◦  The Child Lock  icon turns on when the function is on.



NOTE

- When Child Lock is on, all buttons are disabled except for  and . The washing machine door also locks.
- Tapping a button while Child Lock is on triggers an alarm with the “Child Lock On” message.
- You cannot open the door after a wash cycle when the Child Lock is on. Turn the function off before opening the door to take out the laundry

System functions



Using System Functions

1. Tap and hold for 3 seconds.
2. Turn the Navigation dial and select the desired system function, and then tap .
3. Tap  to change the selected function's settings or start the function.

NOTE To return to the main screen, tap  again or turn the Navigation dial to select Back and tap .



Water Hardness

Set the water hardness according to your region. The detergent concentration level adjusts automatically according to the water hardness setting.

1. Tap and hold  for 3 seconds.
2. Turn the Navigation dial to select Water Hardness, and then tap .
3. Tap  to select the desired setting.
 - The default setting is Med. (Medium).
 - You can select from Med., Hard, or Soft.

Softener



You can change the concentration level of the softener.

1. Tap and hold  for 3 seconds.
2. Turn the Navigation dial to select Softener, and then tap .
3. Tap  to select the desired setting.
 - The default setting is 1x.
 - You can select from 1x, 2x, or 3x.

NOTE The dispense amount of softener decreases as the concentration level increases

AI Pattern



This function saves frequently used cycles and settings. When you turn the function on, the washing machine remembers the cycles you use most and their settings (Temp., Rinse, Spin) and displays them in frequency order.

1. Tap and hold  for 3 seconds.
2. Turn the Navigation dial to select AI Pattern, and then tap .
3. Tap  to select On or Off.
 - The default setting is On. Set it to Off if you do not want to use this function.

- When you turn off the function, all the saved data resets.

Alarm

You can turn on or off the sound from the washing machine. When this function is set to Off, the AddWash alarm, the melody of cycle completion, and the power-off beep does not sound. However, the other sounds stay active.



1. Tap and hold  for 3 seconds.
2. Turn the Navigation dial to select Alarm, and then tap .
3. Tap  to select On or Off.

- The default setting is On.

NOTE The setting remains unchanged even if you restart the washing machine.



Calibration

You can run calibration again for accurate weight detection.

1. Tap and hold  for 3 seconds.
2. Turn the Navigation dial to select Calibration, and then tap 
 - Calibration does not start if the door is not closed properly.
 - The drum rotates clockwise and anticlockwise for about 3 minutes.
3. When calibration is complete, the “Calibration complete” message appears on the display and the washing machine turns off automatically.

Wi-Fi



You can turn the washing machine's Wi-Fi on or off.

1. Tap and hold  for 3 seconds.
2. Turn the Navigation dial to select Wi-Fi, and then tap .
3. Tap  to select On or Off.
 - The washing machine's Wi-Fi is off as a factory default setting. However, the washing machine's Wi-Fi turns on automatically when you turn on the washing machine for the first time. Then, the final Wi-Fi setting maintains regardless of the washing machine power status.
 - Once you turn on the washing machine's Wi-Fi and connect to a network, the washing machine remains connected to the network even when you turn off the power.

- The Wi-Fi  indicates that the washing machine is connected to the router through the Wi-Fi connection.



Language

You can change the system language.

1. Tap and hold  for 3 seconds.
2. Turn the Navigation dial to select Language, and then tap .
3. Turn the Navigation dial to select the desired language, and then tap .

Factory Reset

You can reset the washing machine.

1. Tap and hold  for 3 seconds.
2. Turn the Navigation dial to select Factory Reset, and then tap .
- Your washing machine resets to the factory setting.

Special features

AddWash (applicable models only)

To add laundry after the wash starts, use the AddWash door.

1. Tap and hold  to stop the wash cycle.
2. Press the upper area of the AddWash door to unlock the door. The door will move inward slightly when you press it and then open.

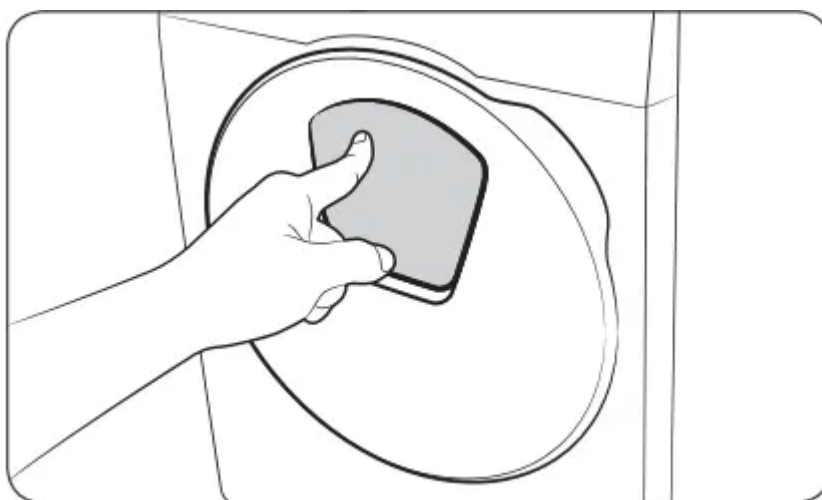

3. Open the AddWash door fully, and then insert additional laundry through the AddWash door into the drum.

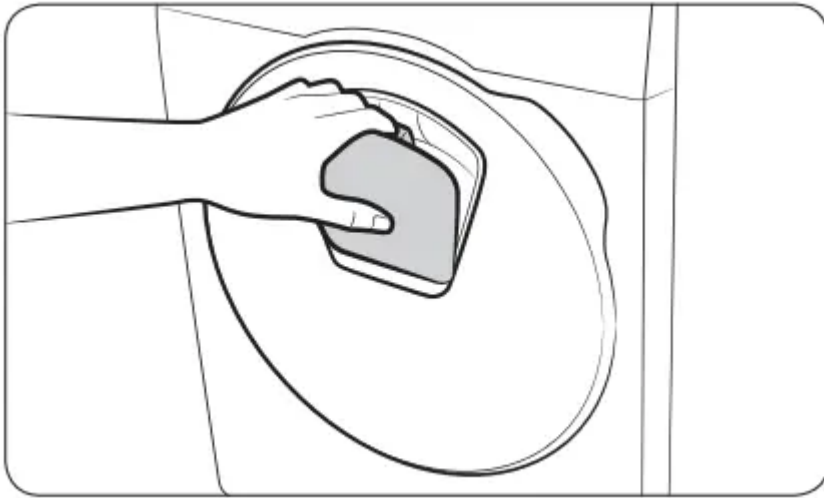

4. Lift the AddWash door back into position, and then lock the door by pushing the upper area of the door until you hear a click. Then, tap and hold  again to resume the wash cycle.



CAUTION Do not put excessive force on the AddWash door. It may break.

NOTE The water inside the drum does not leak if the AddWash door is closed properly. Water drops may form around the AddWash door, but water will not leak from inside the drum. This is normal.

CAUTION

- Do not open the AddWash door if suds have formed inside the drum that rise above the level of the AddWash door.
- Do not attempt to open the AddWash door while the machine is operating without first tapping and holding . Please note that the AddWash door can be opened unintentionally (without tapping and holding ) when the wash is complete.
- Do not add an excessive load through the AddWash door. Performance may be degraded.
- Do not use the lower area of the AddWash door as a handle. Your fingers may be caught.
- Make sure that no laundry is caught in the AddWash door.
- Keep your pets out of the washing machine, especially the AddWash door.
- When using hot water for the wash, the AddWash door may appear to leak water after opening and closing the AddWash door. This is normal, simply because steam emerging from the open AddWash door has cooled and formed water drops on the surface.
- When the AddWash door closes, the door seals up and no water can leak. However, you may encounter what appears to be water leak around the door - some residual water remaining around the AddWash door may form water drops. This is normal.

- Neither the main door nor the AddWash door can be opened when the water temperature is over 50 °C. If the water level inside the drum is over a certain point, the main door cannot be opened.
- If an information code of 'DDC' appears on the display, see the Information codes section for further actions.
- Keep the AddWash door and its surroundings clean at all times. Debris or detergent on or around the seals of the AddWash door may cause a leak.



Adding laundry for non-AddWash models (applicable models only)

1. Tap and hold to stop the wash cycle.
2. Open the door and add the laundry into the drum.
3. Close the door, and then tap and hold again to resume the wash cycle.

Smart control (applicable models only)

You can connect to the SmartThings app and control your washing machine remotely.

Connecting your washing machine

1. Download and open the SmartThings app on your smartphone or tablet (Android & iOS).
2. Tap  to turn on the washing machine.
3. Tap and hold  .
 - a. The washing machine enters AP mode and connects to your smartphone or tablet.
 - b. Tap  to authenticate your washing machine.
 - c. Once the authentication process is complete, your washing machine is successfully connected to the app.
 - You can use various features available in the SmartThings app.

NOTE

- If your washing machine fails to connect with the SmartThings app, try again.
- Check your router if you experience any Internet connection problem after connecting your washing machine with the SmartThings app.
- If the Wi-Fi is off, tap and hold  for 3 seconds to enter the System functions menu, and select Wi-Fi to turn it on.
- Turning the washing machine's Wi-Fi on allows you connect to the washing machine via SmartThings app on your smartphone or tablet, regardless of the power status of the

washing machine. However, the washing machine appears offline on the SmartThings app if the washing machine's Wi-Fi is off.

- Close the door before starting the Smart Control function.
- If you use your washing machine for a while without connecting it to the SmartThings app, a pop-up message about Smart Control will show for 3 seconds.
- If the washing machine's Wi-Fi is not connected to an AP (access point), the Wi-Fi will turn off when you turn of the power.

Stay Connect

Set up the Stay Connect function in your SmartThings app to keep Smart Control turned on at the end of a cycle. Your washing machine stays connected to the app so you can send additional instructions, whether you are at home or away.

1. If you turn on the Stay Connect function on the SmartThings app, the washing machine will stay in standby power saving mode after completing a cycle.
 - The Stay Connect function will remain active for up to 7 days if the door remains closed.
2. When the Stay Connect function is active, the Smart Control, Door Lock, and Wi-Fi icons are illuminated on your washing machine display.
3. You can conveniently control your washing machine, adding rinse, spin or dry cycles using the SmartThings app.

NOTE

- The washing machine switches to standby power saving mode when operation is paused even if the machine is not connected to the SmartThings app.
- In some circumstances, only the Door Lock icon may be illuminated.

SmartThings

Wi-Fi connection

On your smartphone or tablet, go to Settings and turn on the wireless connection and select an AP (Access Point).

This appliance supports the Wi-Fi 2.4 GHz protocols.

Download

On an app market (Google Play Store, Apple App Store, Samsung Galaxy Apps), find the SmartThings app with a search term of "SmartThings". Download and install the app on your device.

NOTE The app is subject to change without notice for improved performance.

Log in

You must first log into SmartThings with your Samsung account. To create a new Samsung account, follow the instructions on the app. You don't need a separate app to create your account.

NOTE If you have a Samsung account, use the account to log in. A registered Samsung smartphone or tablet user automatically logs in.

To register your appliance to SmartThings



1. Make sure your smartphone or tablet is connected to a wireless network. If not, go to Settings and turn on the wireless connection and select an AP (Access Point).
2. Open SmartThings on your smartphone or tablet.
3. If a message of "A new device is found.", select Add.
4. If no message appears, select + and select your appliance in a list of devices available. If your appliance is not listed, select Device Type > Specific Device Model, and then add your appliance manually.
5. Register your appliance to the SmartThings app as follows.
 - a. Add your appliance to SmartThings. Make sure your appliance is connected to SmartThings.
 - b. When registration is complete, your appliance appears on your smartphone or tablet.

Maintenance

Keep the washing machine clean to prevent deteriorated performance and to preserve its life cycle.

Drum clean+

Perform this cycle regularly to clean the drum by removing bacteria from it. This cycle heats the water between 60 °C and 70 °C, and it also removes accumulated dirt from the rubber door gasket.

1. Tap .
2. Turn the Navigation dial to select Drum Clean+.
3. Tap and hold .

CAUTION

- Do not use any cleaning agents for cleaning the drum. Chemical residue in the drum may cause damage to the laundry or the drum of the washing machine.
- To prevent limescale, add the proper amount of detergent according to your local water hardness or add a water softener additive together with the detergent.

Drum Clean+ reminder

Depending on the model, the Drum Clean+ reminder is either an icon or an LED. For icons, the icon lights up on the control panel. For LEDs, the LED lights up next to Drum Clean+, or on the option area of the control panel.

- The Drum Clean+ reminder blinks on the control panel once every 40 washes. It is advisable to perform Drum Clean+ regularly.
- When you first see this reminder blinking, you can ignore the reminder for 6 consecutive washes. From the 7th wash, the reminder no longer appears. However, it appears again on the second 40th wash.
- Even after the last process is terminated, the "0" message may remain.
- You can record the running count of the Drum Clean+ cycle by tapping . This does not stop or turn off the machine but marks your cycle count.
- Even if "0" does not disappear, the machine operates normally.
- It is recommended to run the cycle regularly for hygienic purposes.

Emergency drain

In case of a power failure, drain the water inside the drum before taking out the laundry

1. Power off and unplug the washing machine from the electrical outlet.
2. Gently press the top area of the filter cover to open.

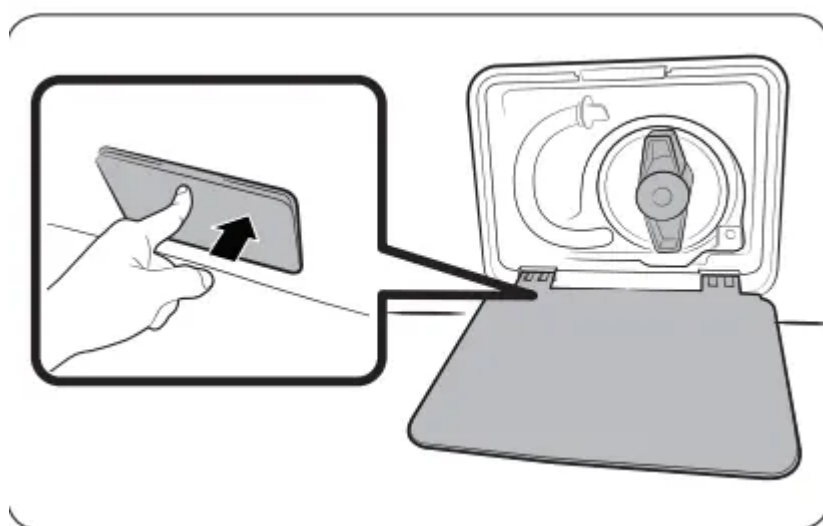

- Put an empty, spacious container around the cover, and stretch the emergency drain tube to the container while holding the tube cap (A).

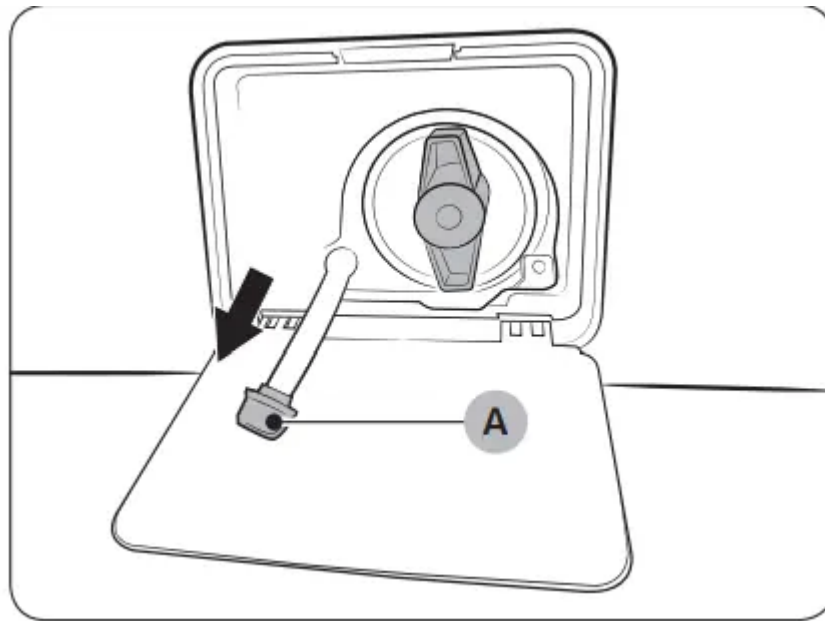

- Open the tube cap and let water in the emergency drain tube (B) flow into the container.
- When done, close the tube cap, and reinsert the tube. Then, close the filter cover.

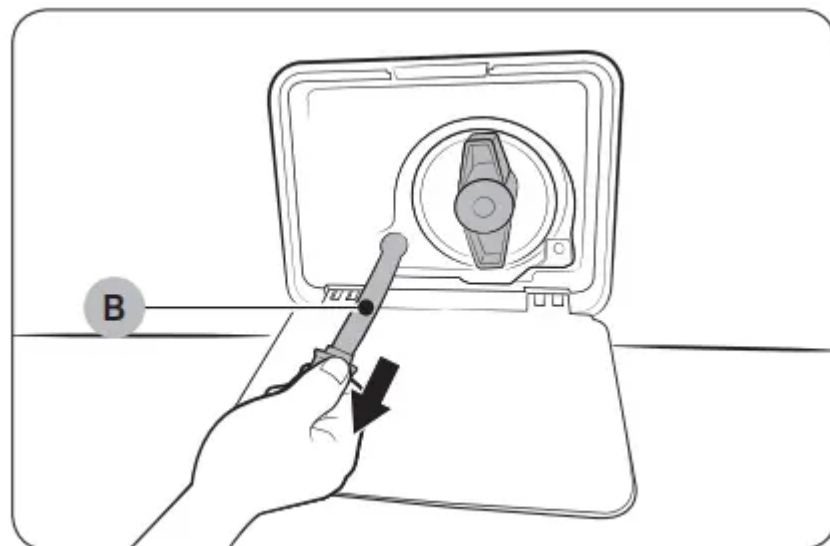

NOTE Use a spacious container because the water in the drum may be more than expected.

Cleaning

Surface of the washing machine

Use a soft cloth with a nonabrasive household detergent. Do not spray water onto the washing machine.

AddWash door



1. Open the AddWash door.
2. Use a wet cloth to clean the AddWash door.
 - Do not use cleaning agents. Discolouration may occur.
 - Use caution when cleaning the rubber packing and the locking mechanism (A).
 - Dust off the door area regularly.
3. Wipe up and close the AddWash door until you hear a clicking sound.

CAUTION

- Do not apply force on the AddWash door. It may break.
- Do not leave the AddWash door open while the machine is operating.
- Do not put heavy objects on the AddWash door at any time.
- To prevent physical injury, do not touch the AddWash door while the drum is rotating.
- Do not open the AddWash door while the machine is operating. This may cause physical injury.
- Do not manipulate the feature panel while the AddWash door is open. This may cause physical injury or system failure.
- Do not input objects other than laundry.
- Do not input bulky items to the drum through the AddWash door.
- Do not pull out the rubber packing of the AddWash door when cleaning. This may cause damage.

Mesh filter

Clean the mesh filter of the water hose once or twice a year.

1. Turn off the washing machine, and unplug the power cord.
2. Close the water tap.

3. Loosen and disconnect the water hose from the back of the washing machine. Cover the hose with a cloth to prevent water from gushing out.

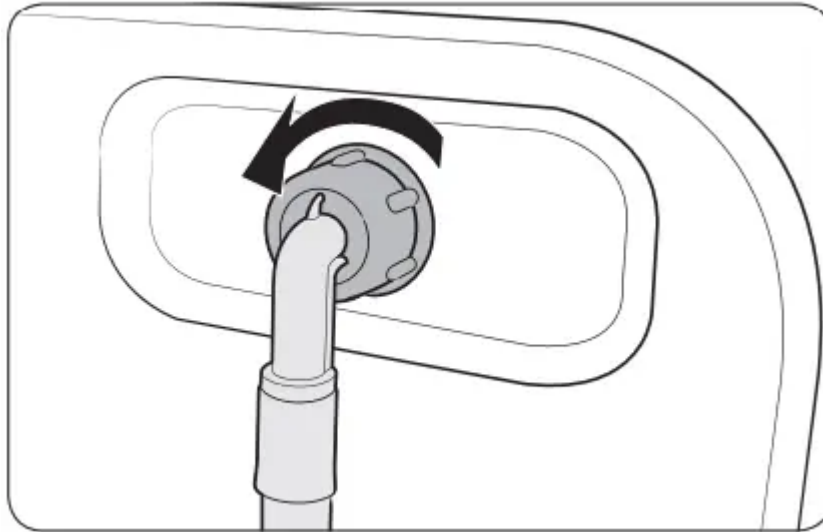

4. Use pliers to pull out the mesh filter from the inlet valve.
5. Submerge the mesh filter deeply in water so that the threaded connector is also submerged.
6. Dry the mesh filter completely in the shade.
7. Reinsert the mesh filter into the inlet valve, and reconnect the water hose to the inlet valve.
8. Open the water tap.

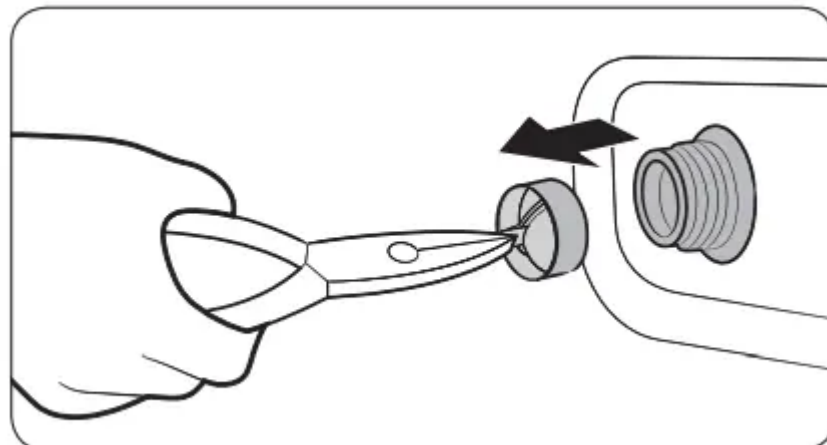

NOTE If the mesh filter is clogged, an information code of “Check water supply” appears on the screen

Debris filter

It is advisable to clean the debris filter every 2 months to prevent its clogging. A clogged debris filter may reduce the bubble effect.

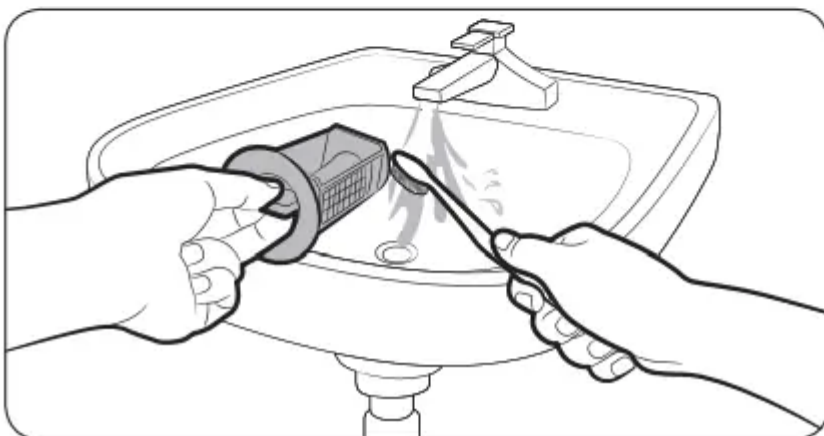
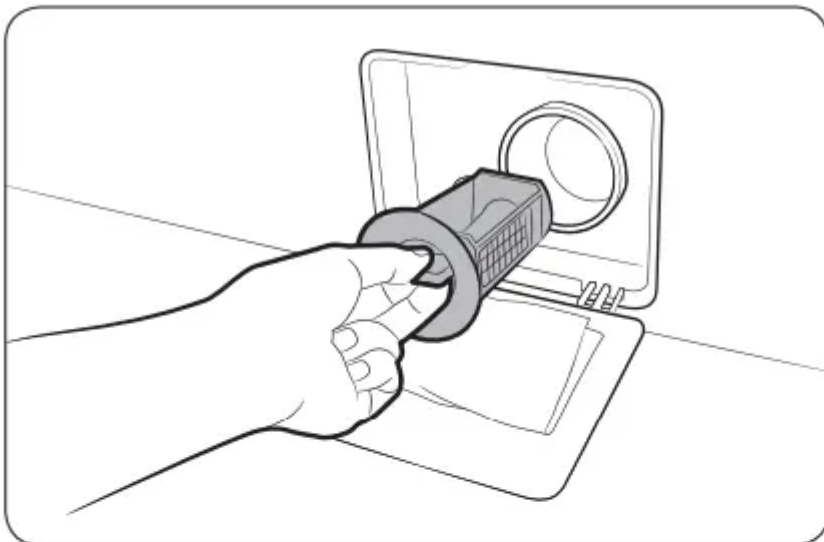

1. Turn off the washing machine, and unplug the power cord.
2. Drain the remaining water inside the drum. See the Emergency drain section.
3. Gently press the top area of the filter cover to open.
4. Turn the debris filter knob to the left, and drain off the remaining water.
5. Clean the debris filter using soft brushes. Make sure the drain pump propeller inside the filter is unclogged.
6. Reinsert the debris filter, and turn the filter knob to the right.

NOTE

- Some debris filters feature a safety knob that is designed to prevent accidents by children. To open the safety knob of the debris filter, push in and turn it anticlockwise. The spring mechanism of the safety knob helps open the filter.
- To close the safety knob of the debris filter, turn it clockwise. The spring makes a rattling sound, which is normal.

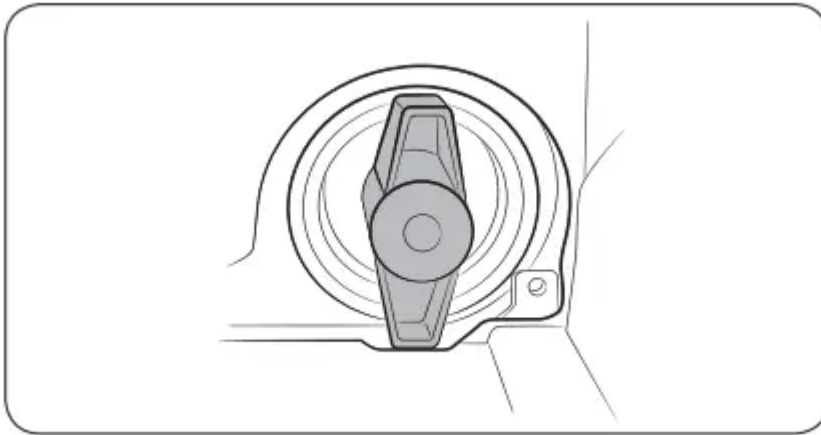

NOTE

If the pump filter is clogged, an information code of “Check drainage” appears on the screen.

CAUTION

- Make sure the filter knob is closed properly after cleaning the filter. Otherwise, this may cause a leak.
- Make sure the filter is inserted properly after cleaning it. Otherwise, this may cause an operational failure or a leak.

Detergent drawer

1. While holding down the release lever on the inner of the drawer, pull the detergent drawer to remove.

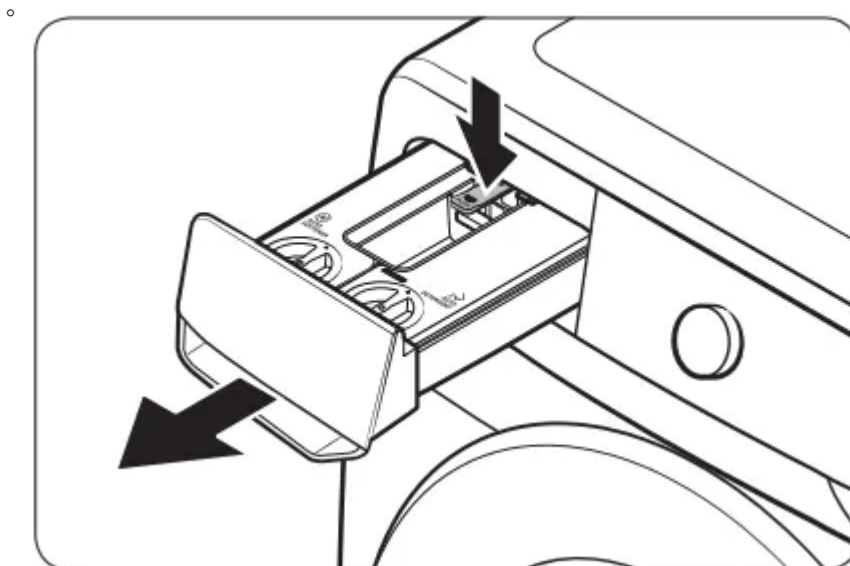

2. Open the cover and clean inside the auto detergent/softener compartments with water.
 - Wipe the water and close the covers when you finish cleaning them.

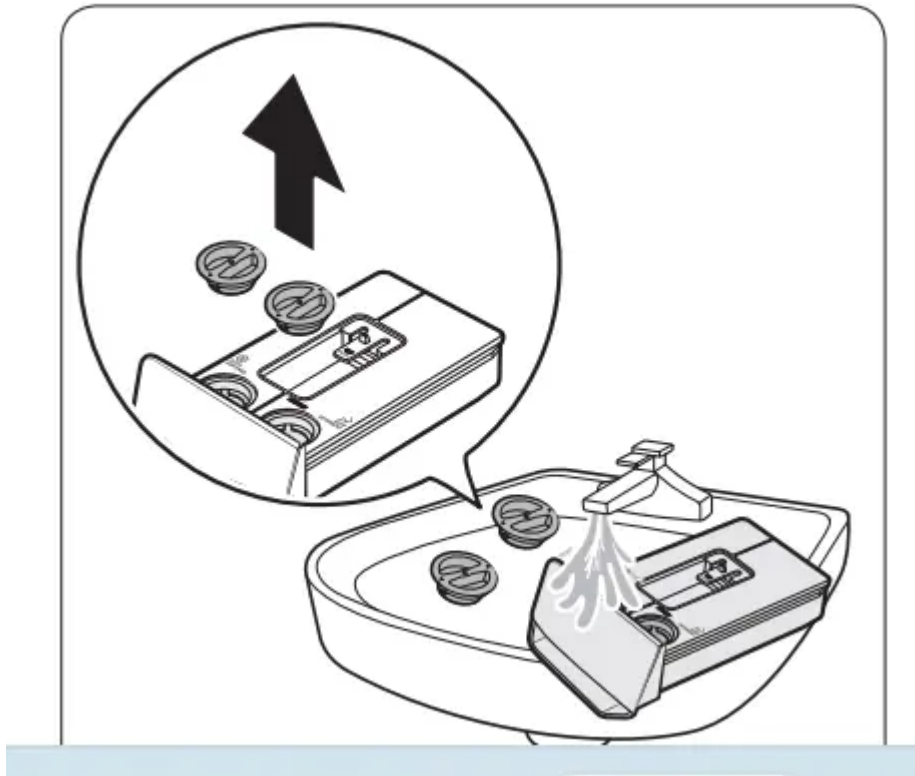

3. Clean the drawer recess using a bottle brush to remove detergent residues and limescale on the drawer recess.

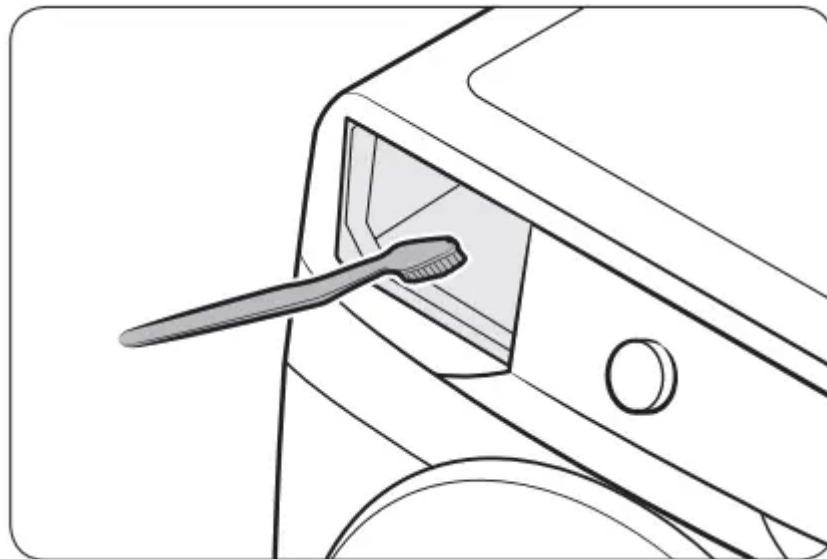

4. Insert the detergent drawer back into the washing machine.

NOTE Make sure the drawer recess is completely dry before inserting the detergent drawer.

CAUTION Do not spray water into the detergent drawer recess. It may cause electric shock or fire.

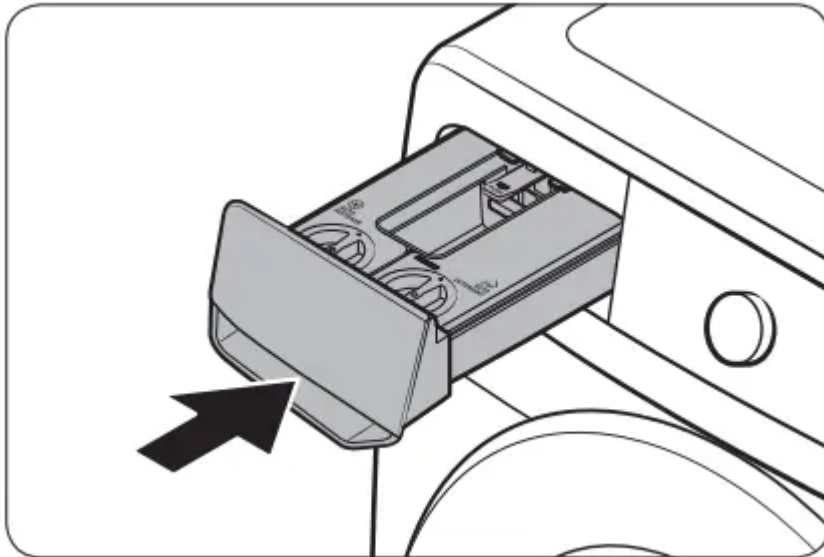

Defrosting your washing machine

The washing machine may freeze when it drops below 0 °C.

1. Turn off the washing machine, and unplug the power cord.
2. Pour warm water over the water tap to loosen the water hose.
3. Disconnect the water hose, and soak it in warm water.
4. Pour warm water into the drum and leave it for about 10 minutes.
5. Reconnect the water hose to the water tap.

NOTE If the washing machine still doesn't operate normally, repeat the above steps until it operates normally

Care against an extended time of disuse

Avoid leaving the washing machine unused for an extended time. If this is the case, drain the washing machine and unplug the power cord.

1. Turn the Navigation dial to select Rinse+Spin.
2. Empty the drum, and then tap and hold .
3. When the cycle is complete, close the water tap and disconnect the water hose.
4. Turn off the washing machine, and unplug the power cord.
5. Open the door to let air circulate through the drum.

Troubleshooting

If there is any problem, check the information message on the LCD screen and follow the on-screen instructions.





If the problem persists, please contact the service center.

Checkpoints

If you encounter a problem with the washing machine, first check the table below and try these suggestions.

Problem & Action

1. Does not start.

- Make sure the washing machine is plugged in.
- Make sure the door is properly closed.
- Make sure the water taps are open.
- Tap and hold  to start the washing machine.
- Make sure Child Lock is not activated.
- Before the washing machine starts to fill, it will make a series of clicking noises to check the door lock and will do quick drain.
- Check the fuse or reset the circuit breaker.
- Check if power is supplied properly.
- Low voltage detected.
 - Check if the power cord is plugged in
- Make sure laundry is not caught in the door.
- The “DDC” message appears when you open the AddWash door without tapping and holding . If this happens, do one of the following:
 - Press the AddWash door to close properly. Then, tap and hold  and try again.
 - To add laundry, open the AddWash door and put in laundry. close the AddWash door completely. Then, tap and hold  to resume operation.

2. Water supply is insufficient, or no water is supplied.

- Fully open the water tap.
- Make sure the door is properly closed.
- Make sure the water supply hose is not frozen.
- Make sure the water supply hose is not kinked or clogged
- Make sure there is sufficient water pressure.
- Make sure that the cold water tap and the hot water tap are properly connected.
- Clean the mesh filter as it may be clogged.

3. After a cycle, detergent remains in the detergent drawer.

- Make sure the washing machine is running with sufficient water pressure.
- Make sure the detergent is added to the centre of the detergent drawer.
- Make sure the rinse cap is inserted properly.
- If using granular detergent, make sure the detergent selector is in the upper position.
- Remove the rinse cap and clean the detergent drawer

4. Excessive vibrations or makes noise.

- Make sure the washing machine is installed on a level, solid floor that is not slippery. If the floor is not level, use the levelling feet to adjust the height of the washing machine.
- Make sure the shipping bolts are removed.
- Make sure the washing machine is not in contact with any other object.
- Make sure the laundry load is balanced.
- The motor can cause noise during normal operation.
- Overalls or clothes with metallic decorations can cause noise while being washed. This is normal.
- Metal objects such as coins can cause noise. After washing, remove these objects from the drum or filter case.
- Redistribute the load. If only one item of clothing needs washing, such as a bathrobe or pair of jeans, the final spin result might be unsatisfactory, and a “Unbalanced laundry detected” check message will be shown in the display.

5. Does not drain and/or spin.

- Make sure the drain hose is straightened all the way to the drain system. If you encounter a drain problem, call for service.
- Make sure the debris filter is not clogged.
- Close the door and tap and hold . For your safety, the washing machine will not tumble or spin unless the door is closed.
- Make sure the drain hose is not frozen or clogged.
- Make sure the drain hose is connected to a drain system that is not clogged.
- If the washing machine is not supplied with sufficient power, the washing machine will temporarily not drain or spin. As soon as the washing machine regains sufficient power, it will operate normally.
- Make sure the drain hose is positioned correctly, depending on the connection type.

- Clean the debris filter as it may be clogged.

6. The door does not open.

- Tap and hold  to stop the washing machine.
- It may take a few moments for the door lock mechanism to disengage.
- The door will not open until 3 minutes after the washing machine has stopped or the power has been off.
- Make sure all the water in the drum is drained.
- The door may not open if water remains in the drum. Drain the drum and open the door manually.
- Make sure the door lock light is off. The door lock light turns off after the washing machine has drained.

7. Excessive suds.

- Make sure you use the recommended types of detergent as appropriate.
- Use high efficiency (HE) detergent to prevent oversudsing.
- Reduce the detergent amount for soft water, small loads, or lightly soiled loads.
- Non-HE detergent is not recommended.

8. Cannot add additional detergent.

- Make sure the remaining amount of detergent and fabric softener is not over the limit.

9. Stops.

- Plug the power cord into a live electrical outlet.
- Check the fuse or reset the circuit breaker.
- Close the door, and tap and hold  to start the washing machine. For your safety, the washing machine will not tumble or spin unless the door is closed.
- Before the washing machine starts to fill, it will make a series of clicking noises to check the door lock and will do quick drain.
- There may be a pause or soak period in the cycle. Wait briefly, and the washing machine may start.
- Make sure the mesh filter of the water supply hose at the water taps is not clogged. Periodically clean the mesh filter.
- If the washing machine is not supplied with sufficient power, the washing machine will temporarily not drain or spin. As soon as the washing machine regains sufficient power, it will operate normally.

10. Fills with the wrong water temperature.

- Fully open both taps.
- Make sure the temperature selection is correct.
- Make sure the hoses are connected to the correct taps. Flush water lines.
- Make sure the water heater is set to supply a minimum of 49 °C hot water at the tap. Also, check the water heater capacity and recovery rate.
- Disconnect the hoses and clean the mesh filter. The mesh filter may be clogged.
- While the washing machine fills, the water temperature may change as the automatic temperature control feature checks incoming water temperature. This is normal.
- While the washing machine fills, you may notice just hot and/or just cold water going through the dispenser when cold or warm temperatures are selected. This is a normal function of the automatic temperature control feature as the washing machine determines the water temperature.

11. Load is wet at the end of a cycle.

- Use the High or Extra High spin speed.
- Use high efficiency (HE) detergent to reduce oversudsing.
- Load is too small. Small loads (one or two items) may become unbalanced and not spin completely.
- Make sure the drain hose is not kinked or clogged.

12. Leaks water.

- Make sure the door is properly closed.
- Make sure all hose connections are tight.
- Make sure the end of the drain hose is correctly inserted and secured to the drain system.
- Avoid overloading.
- Use high efficiency (HE) detergent to prevent oversudsing.
- Check the drain hose.
 - Make sure the end of the drain hose is not placed on the floor.
 - Make sure the drain hose is not clogged.

13. Has odours.

- Excessive suds collect in recesses and can cause foul odours.
- Run cleansing cycles to sanitise periodically.

- Clean the door seal (diaphragm).
- Dry the washing machine interior after a cycle has finished

14. No bubbles are seen (Bubble models only).

- You may not be able to see bubbles if there is too much items in the drum.
- Severely contaminated laundry may not generate bubbles.

15. Can I open the AddWash door at any time?

- The AddWash door can be opened only when the  indicator appears.
- However, it does not open in the following cases:
 - When the boiling or drying process is running and the internal temperature becomes high
 - If you set the Child Lock for safety reasons
 - When the drum wash or drum drying cycle that does not involve additional laundry is running.

16. A message appears on the display to alert that dispenser is open.

- Check if the detergent drawer is closed properly.
 - Open the detergent drawer and close it again. Make sure it's closed properly

If a problem persists, contact a service center. The number of the service center is on the label attached to the product.

Information codes

If the washing machine fails to operate, you may see an information code on the screen. Check the table below and try the suggestions.

1. Check drainage

- Water is not draining
 - Make sure the drain hose is not frozen or clogged.
 - Make sure the drain hose is positioned correctly, depending on the connection type.
 - Clean the debris filter as it may be clogged.
 - Make sure the drain hose is straightened all the way to the drain system.
 - If the information code remains, contact a customer service centre

2. Check water supply

- Water is not supplied.
 - Make sure the water taps are open.
 - Make sure the water hoses are not clogged.
 - Make sure the water taps are not frozen.
 - Make sure the washing machine is operating with sufficient water pressure.
 - Make sure that the cold water tap and the hot water tap are properly connected.
 - Clean the mesh filter as it may be clogged.
 - All buttons will be disabled for 3 minutes after the information code appears.
 - When the “Check water supply” message appears, the machine drains water for 3 minutes. In the meantime, the Power button will be disabled.

3. Check water lines

- Make sure the cold water supply hose is firmly connected to the cold water tap. If it is connected to the hot water tap, the laundry may be deformed with some cycles.



4. Unbalanced laundry detected

- Spinning does not work.
 - Make sure laundry is spread out evenly.
 - Make sure the washing machine is on a flat, stable surface.
 - Redistribute the load. If only one item of clothing needs washing, such as a bathrobe or pair of jeans, the final spin result might be unsatisfactory, and an “Unbalanced laundry detected” check message will be shown in the display.

5. Door is open

- Operating the washing machine with the door open.
 - Make sure the door is properly closed.
 - Make sure laundry is not caught in the door.

6. AddWash door is open (applicable models only)

- This message appears when you open the AddWash door without tapping and holding . If this happens, do one of the following:
 - Press the AddWash door to close properly. Then, tap and hold and try again.
 - To add laundry, open the AddWash door and input laundry. Close the AddWash door properly. Then, tap and hold  to resume operation.

7. OC

- Water has overflowed.
 - Restart after spinning.
 - If the information code remains on the display, contact a local Samsung service centre.

8. LC, LC1

- Check the drain hose.
 - Make sure the end of the drain hose is not placed on the floor.
 - Make sure the drain hose is not clogged.
 - If the information code remains, contact a customer service centre.

9. 3C

- Check the drum motor for operation.
 - Try restarting the cycle.
 - If the information code remains, contact a customer service centre.

10. 3CP

- The electronic control needs to be checked.
 - Try restarting the cycle.
 - If the information code remains, contact a customer service centre

11. UC

- Check the pulsator motor for operation.
 - Check if power is supplied properly.
 - If the information code remains, contact a customer service centre.
- Low voltage detected.
 - Check if the power cord is plugged in.
 - If the information code remains, contact a customer service centre

12. HC

- High temperature heating check.
 - If the information code remains, contact a customer service centre.

13. 1C

- The Water Level sensor is not working properly.
 - Turn the machine off, and restart the cycle.
 - If the information code remains, contact a customer service centre.

14. AC

- Check communications between main and sub PBAs.
 - Turn the machine off, and restart the cycle.
 - If the information code remains, contact a customer service centre.

15. 8C

- The MEMS sensor is not working properly.
 - Turn the machine off, and restart the cycle. • If the information code remains, contact a customer service centre.

16. AC6

- Check communications between the main and the inverter PBAs.
 - Depending on the state, the machine may automatically returns to normal operation.
 - Turn the machine off, and restart the cycle.
 - If the information code remains, contact a customer service centre.

17. DC1

- The Main Door lock/unlock is not working properly
 - Turn the machine off, and restart the cycle.
 - If the information code remains, contact a customer service centre.

18. DC3















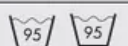

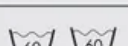

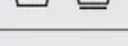

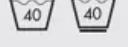



- The AddWash door lock/unlock is not working properly.
 - Turn the machine off, and restart the cycle.
 - If the information code remains, contact a customer service centre.

If any information code keeps appearing on the screen, contact a local Samsung service centre.

Specifications

Fabric care chart

The following symbols provide garment care directions. The care labels include four symbols in this order: washing, bleaching, drying and ironing (and dry cleaning when necessary). The use of symbols ensures consistency among garment manufacturers of domestic and imported items. Follow the care label directions to maximise garment life and reduce laundry problems.

	Resistant material		Do not iron
	Delicate fabric		Can be dry cleaned using any solvent
	Item can be washed at 95 °C		Dry clean
	Item can be washed at 60 °C		Dry clean with perchloride, lighter fuel, pure alcohol or R113 only
	Item can be washed at 40 °C		Dry clean with aviation fuel, pure alcohol or R113 only
	Item can be washed at 30 °C		Do not dry clean
	Hand wash only		Dry flat
	Dry clean only		Can be hung to dry
	Can be bleached in cold water		Dry on clothes hanger
	Do not bleach		Tumble dry, normal heat
	Can be ironed at 200 °C max		Tumble dry, reduced heat
	Can be ironed at 150 °C max		Do not tumble dry
	Can be ironed at 100 °C max		

Protecting the environment

- This appliance is manufactured from recyclable materials. If you decide to dispose of it, please observe local waste disposal regulations. Cut off the power cord so that the appliance cannot be connected to a power source. Remove the lid so that animals and small children cannot get trapped inside the appliance.
- Do not exceed the detergent quantities recommended in the detergent manufacturers' instructions.
- Use stain removal products and bleaches before the wash cycle only when necessary.
- Save water and electricity by only washing full loads (the exact amount depends upon the program used).

Spare parts guarantee

We guarantee that the following spare parts will be available to professional repairers and end-users for a minimum period of 10 years after placing the last unit of the model on the market.

- Door, door hinges and seals, other seals, door locking assembly, and plastic peripherals such as detergent dispensers.

Specification sheet

“*” Asterisk(s) means variant model and can be varied (0-9) or (A-Z).

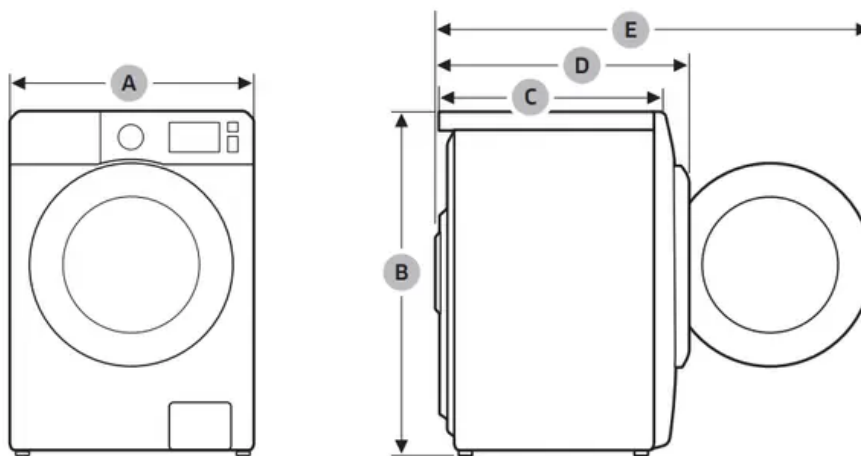

Type		Front loading washing machine	
Model name		WW9*T**4***	
Dimensions	A (Width)	600 mm	
	B (Height)	850 mm	
	C (Depth)	550 mm	
	D	635 mm	
	E	1072 mm	
Water pressure		50-800 kPa	
Net weight		68.0 kg	
Wash and spin capacity		9.0 kg	
Power consumption	Washing and heating	AC 220-240 V / 50 Hz	1900-2300 W
Spin revolutions		1400 rpm	

Type			Front loading washing machine	
Model name			WW8*T**4***	WW8*T**2***
Dimensions	A (Width)		600 mm	
	B (Height)		850 mm	
	C (Depth)		550 mm	
	D		635 mm	
	E		1072 mm	
Water pressure			50-800 kPa	
Net weight			68.0 kg	
Wash and spin capacity			8.0 kg	
Power consumption	Washing and heating	AC 220-240 V / 50 Hz	1900-2300 W	
Spin revolutions			1400 RPM	1200 RPM

Type			Front loading washing machine	
Model name			WW7*T**4***	WW7*T**2***
Dimensions	A (Width)		600 mm	
	B (Height)		850 mm	
	C (Depth)		550 mm	
	D		635 mm	
	E		1072 mm	
Water pressure			50-800 kPa	
Net weight			68.0 kg	
Wash and spin capacity			7.0 kg	
Power consumption	Washing and heating	AC 220-240 V / 50 Hz	1900-2300 W	
Spin revolutions			1400 RPM	1200 RPM

NOTE The design and specifications are subject to change without notice for quality improvement purposes

Warning

This content is compiled from multiple sources and is provided for reference purposes only. It may not be complete or fully applicable to all situations. If you are unable to resolve your issue, please contact the product manufacturer or an authorized service provider for official support.