

## USING THE DISHWASHER

### Getting started

Features and appearance will vary throughout this manual

GDF565

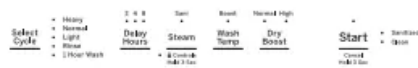

GDF645

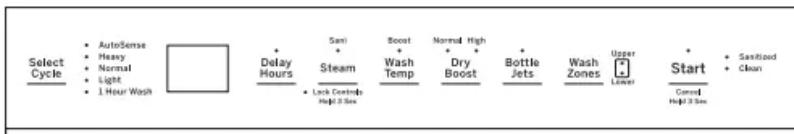

GDT565

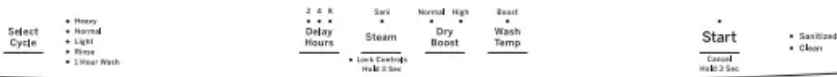

DDT700



GDT665,  
GDT645, GDP645

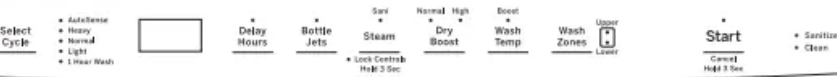

PDT715, PDP715

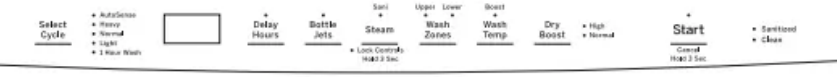

PDT775, PDT785



**Leak Protection (on some models)** If a leak is detected, the dishwasher will drain and the cycle will stop. The display will show “LEAK DETECTED”. Call for service.

**1. Load Dishwasher:** For best dishwashing results, follow the loading guidelines found in the Loading section. No pre-rinsing of normal food soil is required. Scrape off hard soils, including bones, toothpicks, skins, and seeds. Remove leafy vegetables, meat trimmings, and excessive amounts of grease or oil.

**2. Add Detergent:** Add needed amount of detergent to the detergent dispenser. Use detergent such as Finish® Quantum® Automatic Dishwashing Detergent. See Dispensers section.

**3. Add Rinse Agent:** Add rinse agent such as Finish® Jet-Dry® Rinse Aid to the rinse agent dispenser. See Dispensers section.

**4. Select Cycle:** Press the Select Cycle button for the desired wash cycle. On some models, the light next to the Select Cycle button will be lit to indicate which wash cycle has been selected. On

other models, pressing the Select Cycle button will show various cycles in the display window. Press the button until the desired cycle is shown.

**NOTE:** Actual cycle times vary based on soil level, water temperature, and options selected. The cycle may be selected with the door in the open position. The cycle will not start until the Start button is pushed and the door is closed within 4 seconds.

- **AutoSense/Auto (on some models):** This cycle automatically senses the soil level and adjusts the wash cycle accordingly. \*Time range: 1 hour 50 minutes - 2 hours 10 minutes.
- **Heavy/ Pots:** This cycle is meant for heavily soiled dishes, cookware, pots, or pans with dried-on or baked-on soils. Everyday dishes are safe to be used in this cycle. \*Time: 2 hours 31 minutes.
- **Normal:** This cycle is meant for daily, regular, or typical use to completely wash a full load of normally soiled dishes and is designed to conserve both water and energy. \*Time range: 1 hour 15 minutes - 1 hour 50 minutes. **NOTE:** Normal was used to rate the energy efficiency of this dishwasher.
- **Light/ China:** This cycle is for light to medium soiled dishes. It is safe for china and crystal with no options selected. \*Time: 55 minutes.
- **Rinse (on some models):** For rinsing partial loads that will be washed later. Do not use detergent. Detergent is not dispensed during the rinse cycle. \*Time: 16 minutes.
- **Rinse (on some models)** For rinsing partial loads that will be washed later. Do not use detergent. Detergent is not dispensed during the rinse cycle.
- **1-Hour Wash** This cycle will quickly wash lightly soiled dishes. \*Time: 32 minutes. For faster drying, select Heated Dry or Power Dry. The final rinse temperature will be increased. Heated Dry or Power Dry will add 15 to 50 minutes to the cycle time. When the Clean light comes on, open the door, pull the racks out, and the dishes will “flash” dry in approximately five minutes.

\*Washing time only. Does not include drying time, Auto Hot Start, or options. NOTE: If the incoming water temperature is too low, the Auto Hot Start feature may add up to 11 minutes of additional time.

**5. Select Options:** The light by the selected button will be lit to indicate which Option has been selected

- **Normal Temp:** This option is for normally soiled dishes, optimizes wash performance while conserving energy.
- **Wash Temp Boost or Boost Temp:** This option increases the temperature to help clean heavily soiled dishes and will increase the cycle time by 20 to 50 minutes. Option may be turned On or Off during the wash cycle. This option will also improve dry performance on the Normal cycle.

- **Wash Temp Sani or Sanitize Temp**

- This option raises the water temperature in the final rinse to sanitize your dishware but may increase cycle time by 60 minutes. The cycle length will vary depending on the temperature of your inlet water.
- **NOTE:** This option is monitored for sanitization requirements. If the cycle is interrupted during or after the main wash portion or if the incoming water temperature is so low that adequate water heating cannot be achieved, the sanitizing conditions may not be met. In these cases, the Sanitized or Cycle Sanitized light will not illuminate at the end of the cycle. Utilizing this option will modify the cycle to meet the requirements of Section 6, NSF 184 for soil removal and sanitization efficacy.
- **NOTE:** NSF certified residential dishwashers are not intended for licensed food establishments.

- **Dry Boost Off:** Shuts off the drying option. Dishes air dry naturally and energy is saved. Open the dishwasher door to speed drying.

- **Dry Boost Normal:** Turns on the option for faster drying. This option may add up to 85 minutes to the cycle time. On models with the hidden heater feature, this option boosts the temperature of the dishwasher during the final rinse portion of the cycle then utilizes a fan to circulate air to dry the dishes. This very efficient fan may run for an additional 90 minutes after the cycle is complete to maximize drying performance. Fan operation will end if the door is opened during this 90 minute period. This option is not available with the Rinse cycle.

- **Dry Boost High (on some models)** This option can be selected by pressing the Dry Boost pad twice to illuminate the High light. It will add additional time to your drying option, further enhancing the dishwasher's performance for difficult to dry items.

- **Wash Zones (on some models):** Selecting either the Upper or Lower Wash Zones will target dishwashing of just one rack. This will shorten the cycle time and conserve energy. This option should be used when dishes are placed in only one rack.

- **Bottle Jets (on some models):** This option increases the time that the bottle jets are on and may add up to 23 minutes to the cycle time. Use this to wash difficult to clean, dishwasher safe baby bottles, sport bottles, tall coffee cups, etc. See use recommendations in the Loading section.

- **Delay Hours:** Delays the start of a wash cycle up to 8 to 12 hours depending on model. Press Delay Hours, to select the number of hours, then press Start one time and close door to begin countdown. The cycle will start once allotted time has expired.

- **Lock Control**

- You can lock the controls to prevent selections from being made. You can also lock the controls after you have started a cycle to prevent cycle changes. For

example, children cannot accidentally start the dishwasher by pressing buttons with this option selected.

- To LOCK the dishwasher control, depending on the model, press and hold the 1 or 2 buttons indicated on the controls for 3 seconds. On some models, it will be the Heated Dry, another the Steam and Wash Temp buttons, and another model is the Pre-Soak and Bottle Jets buttons. The Control Lock light will turn on to indicate the control is locked.
- To UNLOCK the dishwasher control, depending on the model, press and hold the 1 or 2 buttons indicated on the controls for 3 seconds. The Control Lock light will turn off to indicate the control is unlocked.

## 6. Start Dishwasher

- **Start:** Press the Start button and close the door within 4 seconds to start the cycle or begin the Delay Hours countdown. The wash cycle will begin shortly after closing the door. The display will turn off if the door remains open for two minutes. To activate the display, close and open the door or press any button.
- **Interrupt or Pause:** To interrupt or pause a dish cycle, slowly open the door. Opening the door will cause the wash cycle to pause. The dishwasher will beep every minute to remind you to close the door. To restart or resume the cycle, press Start, and close the door within 4 seconds.
- **Cancel:** To cancel a wash cycle, press and hold the Start button for 3 seconds and close door. The dishwasher will drain, emit a beep sound, and the wash cycle light will turn OFF.

## 7. Cycle Indicator Lights and Sounds

- **Sanitized or Cycle Sanitized:** Displayed at end of the cycle when Wash Temp Sani or Sanitize Temp has been selected and dishwasher has met requirements for sanitization. See Wash Temp Sani or Sanitize Temp, for complete description. Closing door or pressing any button will turn off light.
- **Clean :** Displayed when a wash cycle is complete. The light stays ON as a reminder that the dishes are clean. The light will turn off when the door is opened.
- **Cycle Status (on some models):** The indicator light on the door front will change color to indicate the wash status. During the wash cycle, the indicator light will be amber. When the wash cycle is complete, the light will change to green.
- **Sounds:** The dishwasher will emit a sound to indicate cycle completion, button presses, and door ajar.
- **Mute:** To turn the dishwasher control sounds ON/OFF, press the Heated Dry or Power Dry button 7 times within 5 seconds.

- Sabbath/ Door Wake Up Mode (on some models): To turn this option ON/OFF, press and hold the Start and Wash Temp buttons for 5 seconds, close the door and wait 3 minutes for the dishwasher to go into sleep mode. In the OFF mode, the control display, control sounds, and interior lights (on some models) will not respond to the door opening/closing. This mode can be used when observing certain religious holidays such as the Sabbath. To activate the control and interior lights (on some models), press any button.

## **Dispensers**

### **Check the Water Temperature**

- The entering water should be at least 120°F (49°C) and not more than 150°F (66°C) for effective cleaning and to prevent dish damage. Check the water temperature with a candy or meat thermometer.
- Turn on the hot water faucet nearest the dishwasher, place the thermometer in a glass and let the water run continuously into the glass until the temperature stops rising

### **Use a Rinse Agent**

- Rinse agents, such as Finish® Jet-Dry® Rinse Aid are designed for great drying action and to protect against spots and film build-up on your dishes, glasses, flatware, cookware, and plastic.

### **Filling the Rinse Agent Dispenser**

The rinse agent dispenser holds 3.5 oz. (104 ml) of rinse agent. Under normal conditions, this will last approximately one month.

1. Make sure the dishwasher door is fully open.
2. Open the rinse agent dispenser door.
3. Slowly add rinse agent until the cup is full. You may need to pause several times to allow rinse aid to settle. NOTE: Indicator window does not light up.
4. Clean up any spilled rinse agent with a damp cloth to prevent foam from forming inside the dishwasher.
5. Close the rinse agent dispenser door.

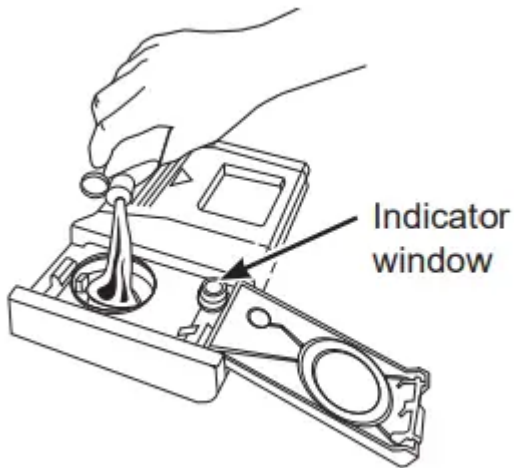

**Rinse Aid Setting:** The amount of rinse agent released into the final wash can be adjusted. If water drops or hard water spots remain on dishes after the dry cycle, increase the setting.



**To adjust the setting:** Open the Rinse Agent dispenser door; then turn the adjuster clockwise to increase the amount of rinse agent, counterclockwise to reduce the amount of rinse agent.

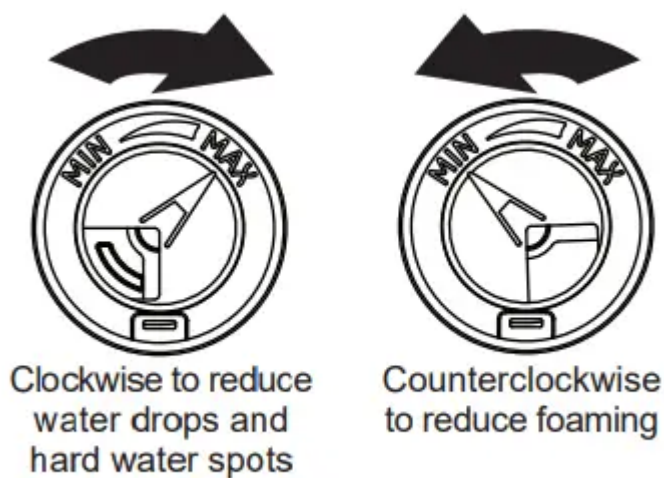

## Detergent Dispenser

- The detergent dispenser is located in the center of the dishwasher door. It has two compartments. The main wash compartment is found inside the detergent dispenser. To open, press the button on the side of the dispenser. The pre-wash compartment is on the lid of the detergent dispenser. Use the pre-wash compartment only when your water is extremely hard or when you have a heavy soiled load. The pre-wash compartment is not used when tablet or packet detergents are used.
- NOTE: Do not load large items in the lower rack where they may block the wash jets from rinsing out the detergent dispenser.

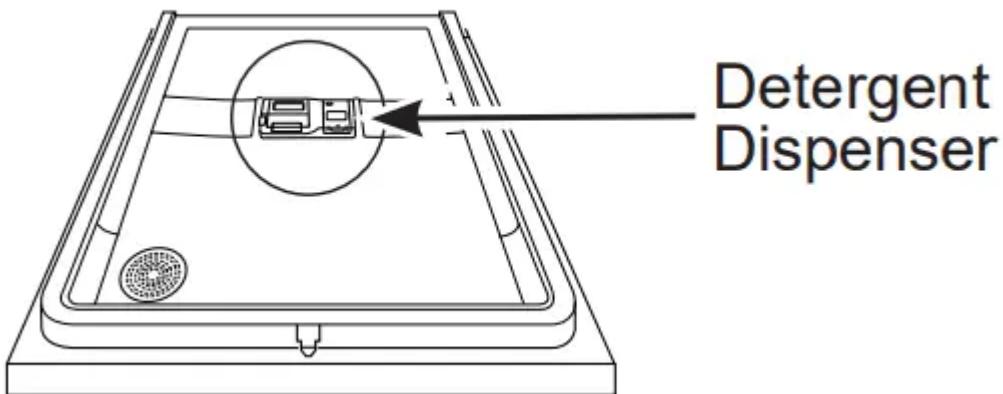

- You may use tablet, packet, powder, liquid or gel automatic dishwasher detergent. Make sure you use only detergents specifically labeled for use in automatic dishwashers. Never use liquid hand dish detergent in an automatic dishwasher. Sudsing and poor wash performance will result with the use of improper detergents.
- Detergents should be stored in a dry location and in their original container to prevent loss of effectiveness. Place detergent in the cup just prior to starting the dishwasher and then close the cover. The cover will open during the wash cycle.

## Filling the Detergent Dispenser

- GE Appliances recommends using detergent in tablet or packet form. Independent testing has shown this form of detergent is very effective in the dishwasher. Finish® Quantum® Powerball® is an example of this type of detergent. Simply put a tablet or packet into the main wash compartment and close the detergent cup cover. Please notice that the tablet or packet must be placed in the main wash compartment of the detergent cup.
- If the tablet or packet is placed in the prewash compartment or tossed in the bottom of the dishwasher, the detergent will be flushed down the drain in a very short period of time and will thus be wasted. Wash performance will be very poor as a result. If you choose to use detergent in powder, liquid or gel form, the amount of detergent you use

will be determined by the hardness of your water, the temperature of your water, and the food soil load inside the dishwasher. Contact your water company to get information about the hardness of the water in your area. Water hardness is measured in grains per gallon. Use this information and the table above to determine the amount of detergent to use. You may purchase a hard water test strip from GE Appliances. Call 1-877-959-8688 and ask for part number WD01X10295. In Canada, call 1-800-661-1616.

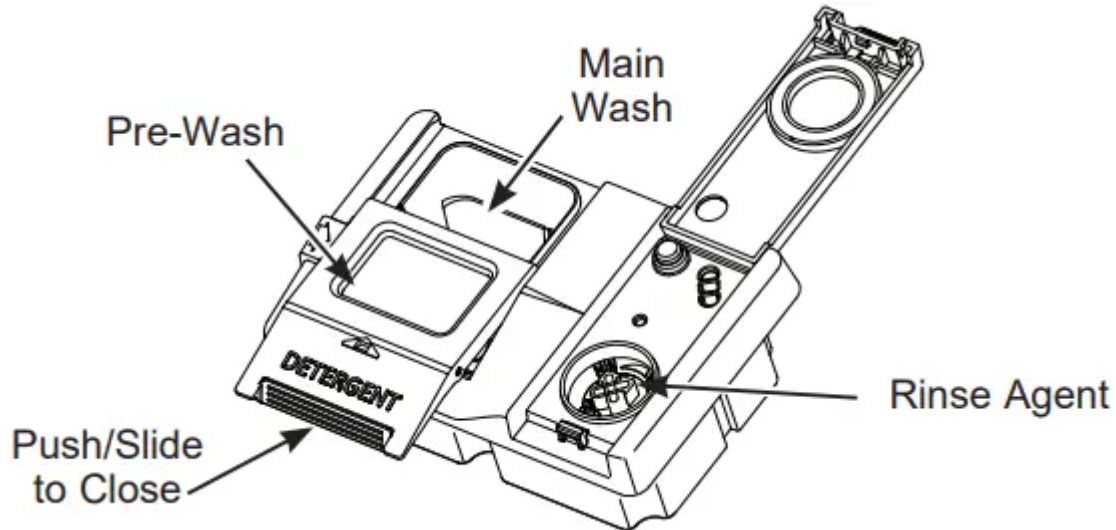

- Use the table as a starting point and then adjust the amount of detergent you use. Use just enough to get good wash performance. Using just the right amount of detergent will provide great wash performance without wasting detergent or etching glassware.

<b>Number of Grains/Gal.</b>	<b>Detergent Cup(s) to Fill</b>
Less than 4	Fill cup to 1/3 full
4 to 8	Fill cup to 2/3 full
8 to 12	Fill cup completely full
Greater than 12	Fill both main wash cup and pre-wash cup

- Using too much detergent with very soft and/or very hot water may cause a condition called etching on your glassware. Etching is a permanent cloudiness in your glassware. This condition is irreversible. However, using too little detergent will cause poor wash performance

- NOTE: Using a detergent that is not specifically designed for dishwashers will cause the dishwasher to fill with suds. During operation, these suds will spill out of the dishwasher vents, covering the kitchen floor and making the floor wet.
- Because so many detergent containers look alike, store the dishwasher detergent in a separate space from all other cleaners. Show anyone who may use the dishwasher the correct detergent and where it is stored.
- While there will be no lasting damage to the dishwasher, your dishes will not get clean using a dishwashing detergent that is not formulated for automatic dishwashers.

## Appliance Communication

### WiFi Connect (on some models) (for customers in the United States)

- Your dishwasher is GE Appliances WiFi Connect capable. A WiFi communication card is built into the product allowing it to communicate with your smartphone for remote monitoring, control and notifications.
- Please visit [GEAppliances.com/connect](http://GEAppliances.com/connect) to connect your appliance, learn more about connected appliance features and learn what connected appliance app's will work with your smartphone.
- WiFi Connectivity: For assistance with the appliance or the ConnectPlus network connectivity, please call GE Appliances at 800-GE-CARES.

This device complies with Part 15 of the FCC Rules. Operation is subject to the following two conditions:

1. This device may not cause harmful interference, and
2. This device must accept any interference received, including interference that may cause undesired operation. This equipment has been tested and found to comply with the limits for a Class B digital device, pursuant to Part 15 of the FCC Rules. These limits are designed to provide reasonable protection against harmful interference in a residential installation. This equipment generates uses and can radiate radio frequency energy and, if not installed and used in accordance with the instructions, may cause harmful interference to radio communications. However, there is no guarantee that interference will not occur in a particular installation. If this equipment does cause harmful interference to radio or television reception, which can be determined by turning the equipment off and on, the user is encouraged to try to correct the interference by one or more of the following measures:
  - Reorient or relocate the receiving antenna.
  - Increase the separation between the equipment and receiver.
  - Connect the equipment into an outlet on a circuit different from that to which the receiver is connected.

- Consult the dealer or an experienced radio/television technician for help.

Labelling: Changes or modifications to this unit not expressly approved by the manufacturer could void the user's authority to operate the equipment.

## Loading

For best dishwashing results, follow these loading guidelines. Features and appearance of racks and silverware baskets may vary from your model.

### Upper Rack

- The upper rack is primarily for glasses, cups, and saucers. For best wash performance, tilt cup and glass openings toward the center of the rack. Other items such as pots, pans, and plates may be placed in the upper rack. This is also a secure place for dishwasher-safe plastic items. The upper rack can be used for odd sized utensils. Sauce pans, mixing bowls, and other similarly shaped items should be placed face down for best wash performance. Ensure small plastic items are secure so that they cannot fall on the heater at the bottom of the dishwasher, potentially damaging the item. Some models are equipped with a hidden heater, so dishwasher safe plastic items can be placed in the lower rack.
- **IMPORTANT:** Ensure items in the upper rack do not interfere with the 3rd Rack (on some models) when loading and unloading.
- **IMPORTANT:** Ensure that items do not protrude through the bottom of the rack or silverware basket where they will block the rotation of the middle spray arm. This could result in noise during operation and/or poor wash performance.
- The Bottle Jets system (on some models) is the ideal location to position baby bottles, tall sports bottles, or other tall items with narrow openings. The Bottle Jets clips hold bottles with small openings in place so water jets are directed inside the bottles to clean hard to reach areas. Clips can be installed or removed by simply slipping the clip opening over the top of the nozzle.

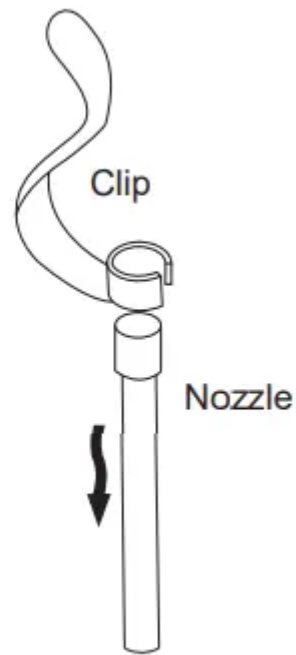
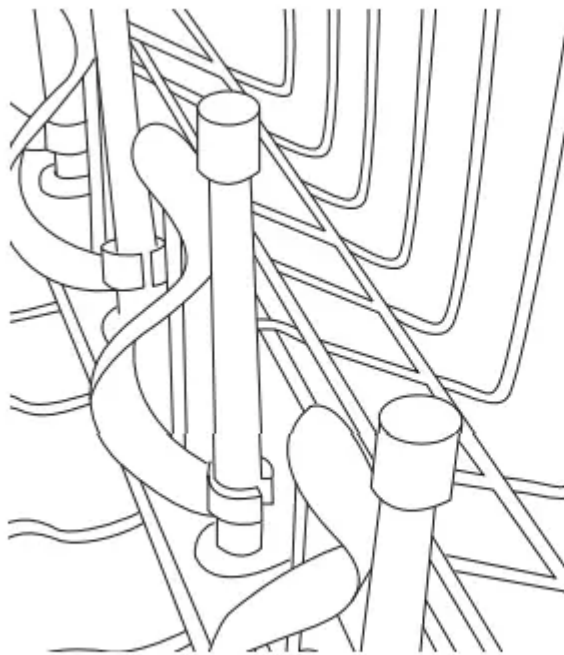

**Bottle Jets**

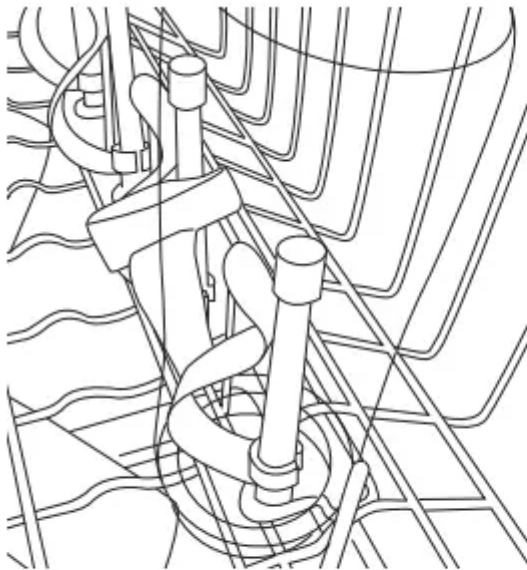

**Sports bottle held in place  
over a Bottle Jets clip**

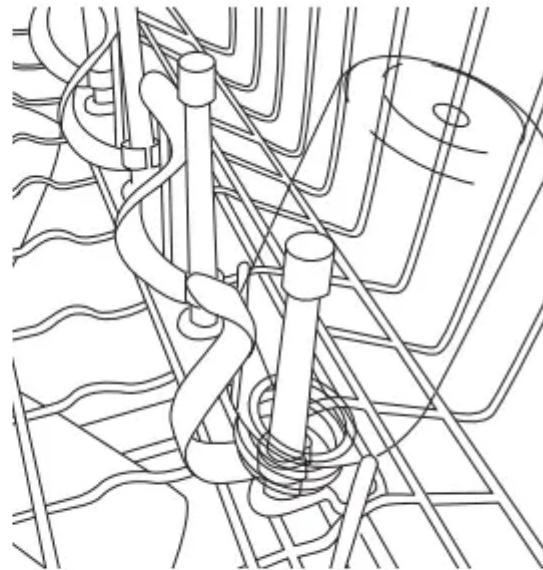

**Baby bottle held in place  
under a Bottle Jets clip**

**CAUTION:** A loaded upper rack may be heavier than anticipated. To prevent minor injury or damage to the contents, do not raise or lower the upper rack after the rack is loaded.

- The upper rack allows 2" of adjustment up or down to accommodate large items. The upper rack may be lowered by pushing the long flaps on each side of the rack. This will allow you to lower the rack (see fig. Upper Rack). To raise the rack, lift up on the rack until the rack locks in place.

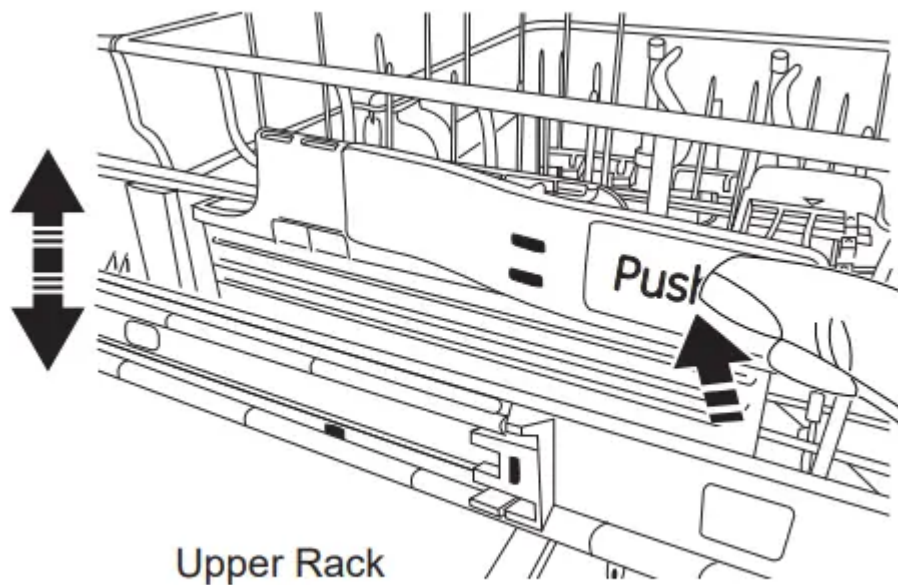

- On some models, the upper rack may be adjusted to accommodate larger items. To adjust the upper rack, fully extend the upper rack and remove the two plastic end caps on the front of the rails. Remove the upper rack. Select the set of rollers on the side of the rack that provides the desired height, and reinstall the upper rack by guiding the rack rails between the appropriate set of rollers. With the rack reinstalled, replace the two plastic end caps, ensuring the snap is properly engaged. Failure to properly engage the end caps may result in the rack falling from the dishwasher.
- To add flexibility in loading, the stem safe shelf (on some models) may be placed in the up or down position or unfolded and placed in the lower unfolded position.
- The shelf may also be used to secure stemware such as wine glasses. Because these stemware items come in various sizes, slowly push the rack in to ensure the items do not bump into the edges of the dishwasher, which may cause damage to the items.
- The fold down tines (on some models) provide flexibility for extra-large and hard-to-fit items. The tine rows can be adjusted to a vertical or lay-down position.

For best dishwashing results, follow these loading guidelines. Features and appearance of racks and silverware baskets may vary from your model.

**8 Place Settings - Upper Rack 10 Place Settings - Upper Rack**

Models - GDF565, GDT565, GDF645, GDP645,  
GDT645, GDT665, DDT700, PDP715, PDT715,  
PDT775, PDT785

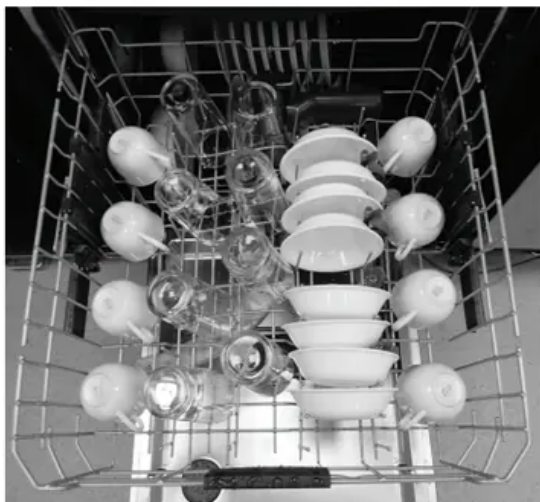

Models - GDF565, GDT565, GDF645, GDP645, GDT645,  
GDT665, DDT700, PDP715, PDT715, PDT775, PDT785

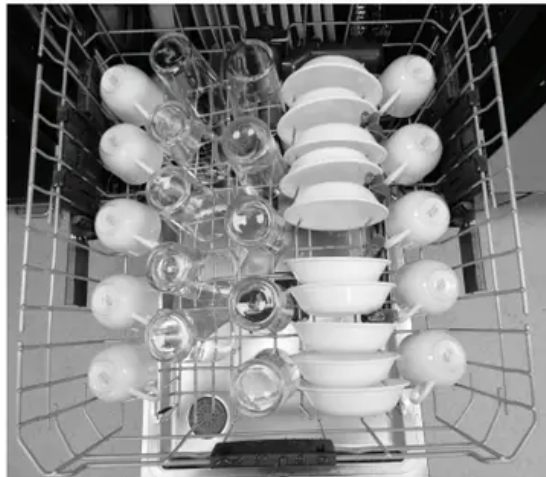

**12 Place Settings - Upper Rack**

Models - GDF645, GDP645, GDT645, GDF565,  
GDT565, PDT775



Models - DDT700, GDT665, PDP715, PDT715



Models - PDT785

**Models - PDT785**



For best dishwashing results, follow these loading guidelines. Features and appearance of racks and silverware baskets may vary from your model.

### **Lower Rack**

- The lower rack is best used for plates, saucers and cookware items. Large items, such as broiler pans and baking racks should be placed along the sides of the rack. If necessary, oversized glasses and mugs can be placed in the lower rack to maximize loading flexibility. Plates, saucers and similar items should be placed between the tines in the direction that allows the item to remain secure in the rack.
- NOTE: Do not load large items in the lower rack where they may block the wash jets from rinsing out the detergent dispenser.

- The lower rack fold down tines (on some models) can be adjusted to different upright angles or placed flat to provide flexibility for hard-to-fit or extra-large items.

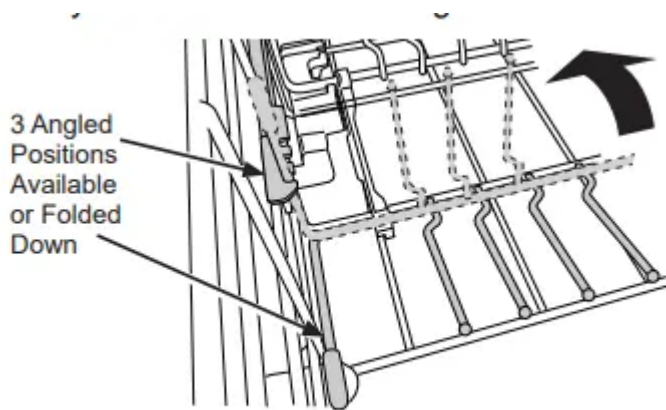

- To change the direction of the fold down tines, lower the tines, then pull away from the bar clips that secure the tines to the rack and remove. Reverse the direction of the tines, orienting the handle on the opposite side of the rack. Reattach the tines to the bar clips by pushing the tines back until they click in place. The indexer will also need to be switched to the opposite side of the dishwasher. To remove the indexer, simply slide it in the direction labeled "unlock." Then, align the indexer with the rack on the other side and slide in the direction that says "lock" in order to reattach the indexer to the rack.
- **IMPORTANT:** It is important to ensure that items do not protrude through the bottom of the rack or the silverware basket where they will block the rotation of the lower spray arm. Also, ensure that large plates, pots, or tall items don't hit the mid spray arm. This could result in noise during operation and/or poor wash performance.

### 8 Place Settings - Lower Rack

Models - GDF565, GDT565, GDF645, GDP645, GDT645

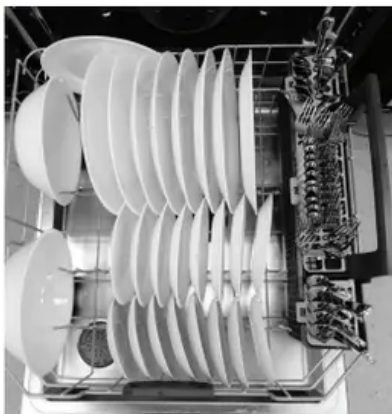

Models - DDT700, GDT665, PDP715, PDT715, PDT775, PDT785

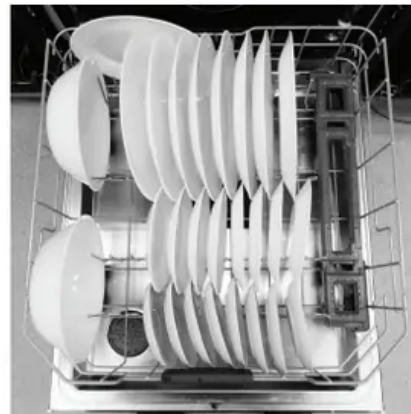

### 10 Place Settings - Lower Rack

Models - GDF565, GDT565, GDF645, GDP645, GDT645

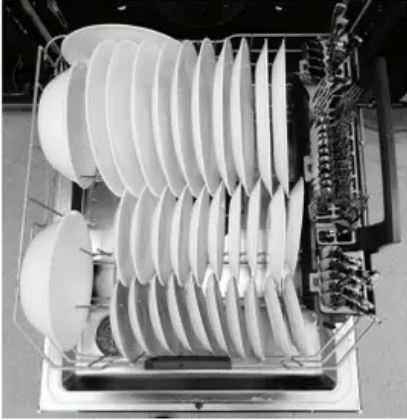

Models - DDT700, GDT665, PDP715, PDT715, PDT775, PDT785

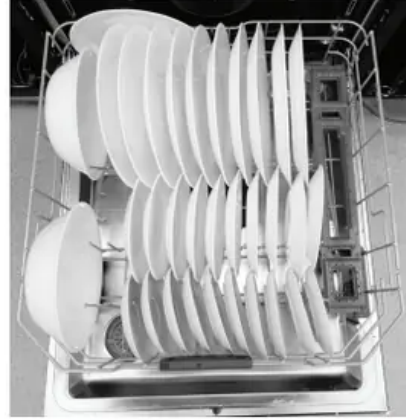

### 12 Place Settings - Lower Rack

Models - GDF645, GDP645, GDT645, GDF565, GDT565, PDT775

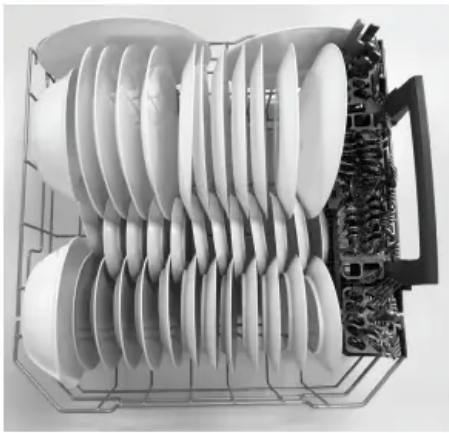

Models - DDT700, GDT665, PDT715, PDT785



For best dishwashing results, follow these loading guidelines. Features and appearance of racks and silverware baskets may vary from your model.

### 3rd Rack (on some models):

- The 3rd rack is the recommended location for silverware and large utensils
- CAUTION: Take care when loading, unloading, or transporting the silverware or utensil tray. The tray may contain sharp or heavy items. If items are dropped from the tray or the tray is dropped, injury could occur.

### IMPORTANT NOTES:

- Do not allow cutlery of different materials to touch each other in the 3rd rack. Doing so may cause discoloration of the cutlery.
- The tray is only meant to be used with a GE Appliances 3rd rack dishwasher to hold silverware, cooking utensils, and other small items. Using the tray for any other purpose could result in damage to the tray or damage to anything interacting with the tray.

- Ensure that the 3rd rack is fully closed before shutting the dishwasher door. Shutting the door with the rack partially

The 3rd rack is also removable to allow extra large items to be placed in the upper rack: To remove the 3rd rack:

1. With the rack fully extended, lift the front of the rack so that the rack roller wheels clear the retaining hook.
2. Continue to pull the rack until the remaining rack roller wheels clear the retaining hook.
3. Replace the rack by aligning the rack roller wheels on the retaining hook and rack rails – Ensure all roller wheels are located on top of the rack rails.

Silverware/flatware is loaded using the silverware basket lids. This ensures great wash performance of the silverware. Loading in this manner prevents nesting and makes sure all items are washed uniformly.

### **Silverware Basket**

- Place flatware in the removable silverware baskets. Sharp objects, such as forks and knives, may be placed with the handles facing up, in order to protect your hands. For the best wash performance, place other items such as spoons with the handles facing down. Avoid allowing items to nest together, which may keep them from being properly washed. When loading, distribute items evenly in the basket.
- The silverware baskets may also be used for small items, such as measuring spoons, baby bottle nipples, plastic lids, or corn cob holders. The silverware basket covers can be closed to contain small items.
- **IMPORTANT:** Do not load large or tall utensils where they may block the detergent dispenser, mid spray arm, or become trapped between the door and the gasket when the door is closed.

### **Deep Clean Silverware Jets (on some models)**

- Deep Clean Silverware Jets target stubborn, stuck-on food and help separate nested spoons and forks to keep your silverware spotless no matter how you load the silverware. For optimal silverware cleaning, the use of silverware basket lids is always recommended. For models with the third rack, the Deep Clean Silverware Jets can also be used to clean mixing bowls and other cookware.
- Do not remove Deep Clean Silverware Jet spray assembly from the dishwasher rack.

**Silverware Basket - 8 Place Settings**  
Models - GDF565, GDT565, GDF645,  
GDP645, GDT645



**Silverware Basket - 10 Place**  
Settings Models - GDF565, GDT565,  
GDF645, GDP645, GDT645



**Silverware Basket - 12 Place**  
Settings Models - GDF565, GDT565,  
GDF645, GDP645, GDT645



**Silverware Basket - 8 Place Settings**  
Models - GDT665, DDT700, PDP715,  
PDT715, PDT775, PDT785

**NOTE:** Refer to the 3rd Rack in this  
Loading The Dishwasher section.

**Silverware Basket - 10 Place Settings**  
Models - GDT665, DDT700, PDP715,  
PDT715, PDT775, PDT785

**NOTE:** Refer to the 3rd Rack in this  
Loading The Dishwasher section.

**Silverware Basket - 12 Place**  
Settings Models - GDT665,  
DDT700, PDP715, PDT715,  
PDT775, PDT785



## Care and cleaning

### Control Panel

- To clean the control panel, use a lightly dampened cloth. Then dry thoroughly.

### Exterior Door Panel

- Before cleaning the front panel, make sure you know what type of panel you have. Refer to the last two letters of your model number. You can locate your model number on the left-hand tub wall just inside the door. If your model number ends with BB, CC, WW, SA, ES, DS or TS then you have a painted door panel. If your model number ends with SS, then you have a Stainless Steel door panel. If your model number ends with II, then you have an Integrated door panel.
- Follow the instructions below for cleaning the door panel for your specific model.
- Painted Door Panel (model numbers ending in BB– black, CC–bisque, WW–white, SA–silver, ES–slate, DS–black slate or TS–black stainless steel): Use a clean, soft, lightly dampened cloth, then dry thoroughly
- Stainless Steel Door Panel (model numbers ending in SS)
  - For cleaning rust and tarnish, cleaners with oxalic acid such as Bar Keepers Friend Soft Cleanser™ will remove rust, tarnish and small blemishes. Use only a liquid cleanser free of grit and rub in the direction of the brush lines with a damp soft sponge. Do not use appliance wax or polish on the stainless steel.
  - For other blemishes and marks, use Stainless Steel Magic or a similar product using a clean soft cloth. Do not use appliance wax, polish, bleach or products containing chlorine on Stainless Steel. You can order Stainless Steel Magic #

WX10X29 through GE Appliances Parts by calling 877.959.8688. In Canada, call 1-800-661-1616.

- Integrated Door Panel (model numbers ending in II): This is a custom installed door panel, and you will need to refer to the cabinet manufacturers recommendations for proper cleaning.

## **Dishwasher Interior**

- To clean and de-odorize your dishwasher, use citric acid or Finish® Dishwasher Cleaner, a detergent additive. Finish® Dishwasher Cleaner will break up mineral deposits, and remove hard water film and stains. You can order citric acid GE Appliances kit #WD35X151 through GE Appliances Parts by calling 877-959-8688 or visiting [GEApplianceparts.com](http://GEApplianceparts.com). In Canada, call 1-800-661-1616. You can purchase Finish® Dishwasher Cleaner at your local grocery store.

## **Stainless Steel Inner Door and Tub**

- The stainless steel used to make the dishwasher tub and inner door provides the highest reliability available in a GE Appliances dishwasher.
- If the dishwasher tub or inner door should be scratched or dented during normal use, they will not rust or corrode. These surface blemishes will not affect their function or durability

## **Filters**

Inspect and clean the filters periodically. This should be done every other month or more depending on usage. If there is a decrease in wash performance or dishes feel gritty, this is also an indication the filters need to be cleaned.

**WARNING:** The retaining posts can be a choke hazard for small children if removed from the dishwasher. Keep out of reach of children.

### **Ultra-Fine Filter**

- To clean the Ultra-Fine Filter, remove the bottom rack. Twist the Ultra-Fine Filter counterclockwise and lift to remove. Rinse filter with warm soapy water and use a sponge to carefully remove any stubborn particles. Scrubbing with scouring pads or brushes can damage the filter. Once cleaned, replace the Ultra-Fine Filter, and twist it clockwise to lock in place.

### **Fine Filter**

- To clean the Fine Filter (mesh plate), remove the bottom rack. Remove the Ultra-Fine Filter.

- Twist each of the two retaining posts located toward the back bottom of the tub counterclockwise, and remove the Fine Filter. Rinse filter with warm soapy water. Scouring pads or brushes can scratch the filter surface but a soft brush or sponge may be needed to remove stubborn soils or calcium deposits caused by hard water. Once cleaned, replace the Fine Filter and the Ultra-Fine Filter. Twist the two retaining posts clockwise to lock in place.

## Protect Against Freezing

If your dishwasher is left in an unheated place during the winter, ask a service technician to:

1. Turn off electrical power to the dishwasher. Remove fuses or trip circuit breaker.
2. Turn off the water supply and disconnect the water inlet line from the water valve.
3. Drain water from the water inlet line and water valve. (Use a pan to catch the water.)
4. Reconnect the water inlet line to the water valve.

## Does Your Dishwasher Have an Air Gap?

An air gap protects your dishwasher against water backing up into it if a drain clogs. The air gap is not a part of the dishwasher. It is not covered by your warranty. Not all plumbing codes require air gaps, so you may not have one.

The air gap is easy to clean.

1. Turn off the dishwasher and lift off the air gap cover.
2. Remove the plastic cap under the cover and clean with a toothpick.
3. Replace the cap and cover when the air gap is clean.

## Troubleshooting Tips

... Before you call for service

### 1. Start status indicator light flashing

- The door was opened or the cycle was interrupted.
  - Press the Start button once and close the door within 4 seconds to start the dishwasher. Press the Start button a second time when the dishwasher is running only if you wish to cancel the cycle.

### 2. Dishwasher BEEPS once every minute

- This is a reminder that your dishwasher door has been left open during operation. It will continue beeping until you press Start and close the door.
  - Press Start and close the door

### 3. Display shows “LEAK DETECTED”

- Possible leak is detected
  - Some models are equipped with leak detection and the cycle will be cancelled if a leak is detected. The display will show “LEAK DETECTED”. Call for service.

### 4. Beeping at the end of the cycle (on some models)

- This is normal. Dishwasher will beep twice at the end of the cycle.
  - To turn off the double beep indicator (or re-activate it if it was previously turned off), press the Heated Dry button 5 times within 3 seconds. A triple beep will sound to indicate the end-of-cycle beep option has been turned on or off.

### 5. Dishes and flatware not clean

- Ultra-Fine Filter or Fine Filter is clogged
  - See the Care and Cleaning section.
- Low inlet water temperature
  - Make sure inlet water temperature is correct (see the USING THE DISHWASHER section). Turn on the hot water faucet nearest the dishwasher, let run until the water temperature stops rising. Then start the dishwasher and turn off the faucet. This ensures the entering water is hot. Select Wash Temp Boost or Boost Temp if available.
- Water pressure is temporarily low
  - Turn on a faucet. Is water coming out more slowly than usual? If so, wait until pressure is normal before using your dishwasher. Normal water pressure to the dishwasher should be 20-120 psi.
- Air gap or disposer clogged
  - Clean the air gap or flush the disposer.
- High drain loop or air gap not installed
  - Refer to the Installation Instructions for proper drain line installation.
- Improper rack loading
  - Make sure large dishware does not block the detergent dispenser or the wash arms. See the Loading section.
- Poor performing detergent
  - Use a highly rated detergent such as Finish® Quantum® Automatic Dishwashing Detergent.

## 6. Spots and filming on glasses and flatware

- Extremely hard water
  - Use rinse agents such as Finish® Jet-Dry® Rinse Aid to prevent spots and prevent new film build-up. If water is extremely hard, a softener may be required.
- Low inlet water temperature
  - Make sure water temperature is at least 120°F (49°C).
- Overloading or improper loading of the dishwasher
  - Load dishwasher as shown in the Loading section.
- Old or damp powder detergent
  - Make sure detergent is fresh. Use a highly rated detergent such as Finish® Quantum® Automatic Dishwashing Detergent.
- Rinse agent dispenser empty
  - Refill with rinse agent such as Finish® Jet-Dry® Rinse Aid.
- Too little or low performing detergent
  - Make sure you use the proper amount of highly rated detergent.

## 7. Cloudiness on glassware

- Combination of soft water and too much detergent
  - This is called etching and is permanent. To prevent this from happening, use less detergent if you have soft water. Wash glassware in the shortest cycle that will get it clean.
- Low performing phosphatefree detergent
  - See A white film on glassware, dishware and the interior in this TROUBLESHOOTING section.
- Water temperature entering the dishwasher exceeds 150°F (66°C)
  - This could be etching. Lower the water heater temperature.

## 8. Suds in the tub

- Wrong detergent
  - Use only automatic dishwasher detergents to avoid sudsing. Finish® Quantum® Automatic Dishwashing Detergent has been approved for use in all GE Appliances dishwashers. To remove suds from the tub, open the dishwasher and let suds dissipate. Open the door, press and hold Start for 3 seconds, and close the door.

- Rinse agent was spilled
  - Always wipe up rinse agent spills immediately.

#### 9. Detergent left in dispenser cups

- Dishes or utensils are blocking the detergent cup
  - Reposition the dishes, so the water from the lower spray arm can flush the detergent cup. See the Loading section. Reposition the tall utensils or heavy silverware that may be keeping the dispenser cup door from opening. See the Loading section. Don't place large bowls or pots directly under the detergent dispenser.

#### 10. Black or gray marks on dishes

- Aluminum utensils have rubbed against dishes
  - Remove marks with a mild, abrasive cleaner.

#### 11. Dishes don't dry

- Low inlet water temperature
  - Make sure inlet water temperature is at least 120°F. Select Heated Dry. Use Wash Temp Boost or Boost Temp option. Select a higher cycle, such as Wash Temp Sani, Sanitize Temp or Heavy.
- Rinse agent dispenser is empty
  - Check the rinse agent dispenser and fill as required.
- Additional drying time is needed
  - Leave door closed after the Clean light appears to allow the fan to run an additional 90 minutes. Note: If you open the door, this fan extension will be cancelled.

#### 12. Control panel responded to inputs but dishwasher never filled with water

- Door may not be completely closed
  - Make sure the door is firmly closed.
- Water valve may be turned off
  - Make sure water valve (usually located under the sink) is turned on.
- Flood float may be stuck
  - Remove Ultra-Fine filter and lightly tap the piece under the ultra fine filter that looks like a salt shaker. Replace the filter.

### 13. Stained tub interior

- White film on inside surface— hard water minerals
  - GE Appliances recommends Finish® Jet-Dry® Rinse Aid to help prevent hard water mineral deposits from forming. Run dishwasher with citric acid to remove mineral deposits. Citric acid (Part number: WD35X151) can be ordered through GE Appliances Parts. See back cover for ordering information. Alternatively, purchase Finish® Dishwasher Cleaner and follow the directions on the label.

### 14. Dishwasher won't run

- Fuse is blown or circuit breaker is tripped
  - Replace fuse or reset circuit breaker. Remove any other appliances from the circuit.
- Power is turned off
  - In some installations, the power to the dishwasher is provided through a wall switch, often located next to the disposer switch. Make sure it is on.
- Control panel is locked
  - Unlock control panel. See the Getting started section.
- Possible leak is detected
  - Some models are equipped with leak detection and the cycle will be cancelled if a leak is detected. The display will show "LEAK DETECTED". Call for service.
- Proper Start sequence was not followed
  - See the Using the dishwasher section.

### 15. Control panel lights go off when you're setting controls

- Time too long between touching of selected buttons
  - Each button must be touched within 30 seconds of the others. To relight, touch any button again or open the door and unlock (top control).

### 16. Water standing in the bottom of the tub

- Air gap is clogged
  - Clean the air gap. See the Care and Cleaning section.
- High drain loop or air gap not installed
  - Refer to the Installation Instructions for proper drain line installation.

## 17. Water won't pump out of the tub

- Drain is clogged
  - If you have an air gap, clean it. See the Care and Cleaning section. If the dishwasher drains into a disposer, run disposer clear. Check to see if your kitchen sink is draining well. If not, you may need a plumber

## 18. Steam

- This is normal
  - Warm, moist air comes through the vent during drying and when water is being pumped out. This is necessary for drying.

## 19. Sanitized or Cycle Sanitized light does not illuminate at the end of the cycle

- The door was opened and the cycle was interrupted during final rinse
  - Do not interrupt the cycle by opening the door during the wash cycle.
- The incoming water temperature was too low
  - Raise the water heater temperature to between 120°F and 150°F.

## 20. Noise

- Normal operating sounds: Beeping at the end of the cycle (on some models) Detergent cup opening Water entering dishwasher Motor stops and starts at various times during cycle Spray arms start and stop at various times Drain pump sounds during pump out Drain pump starts and stops several times during each drain
  - These are all normal. No action is required.
- Rattling dishes when the spray arm rotates
  - Make sure dishes are properly loaded. See the Loading section.
- Rattling silverware against door during wash
  - Tall utensils may be placed in the upper rack to avoid bumping against inner door during wash cycle.

## 21. A white film on glassware, dishware and the interior

- This problem is likely caused by a low quality phosphate-free dishwasher detergent
  - To remove the white film, run your dishes through a dishwasher cycle with citric acid. Use a WD35X151 citric acid kit found online. Otherwise, use Finish® Dishwasher Cleaner found at your local grocery store. Pour the citric acid in the detergent cup and close the cover. Place the filmed but otherwise clean glassware and dishware in the dishwasher. Leave silverware and other metal items out of the dishwasher. Turn the dishwasher on and let it run through a complete cycle without detergent. The glassware, dishware, and dishwasher

should come out film free. Alternatively, a vinegar rinse may be used. Pour 1 cup of vinegar into dishwasher just after the detergent cup opens and let the dishwasher complete its cycle. This may be repeated several times a year as needed. The use of a rinse agent such as Finish® Jet-Dry® Rinse Aid may help minimize a repeat build up of film. Also, the use of a highly rated detergent such as Finish® Quantum® Automatic Dishwashing Detergent will help prevent film build-up.

**Warning**

This content is compiled from multiple sources and is provided for reference purposes only. It may not be complete or fully applicable to all situations. If you are unable to resolve your issue, please contact the product manufacturer or an authorized service provider for official support.