

Installation

This dryer must be installed by a qualified technician. The installer is responsible for connecting the dryer to the main power while observing the relevant safety regulations of your area.

What's included

Make sure all the parts are included in the product package. If you have a problem with the dryer or the accessories, contact a local Samsung service center or the retailer.

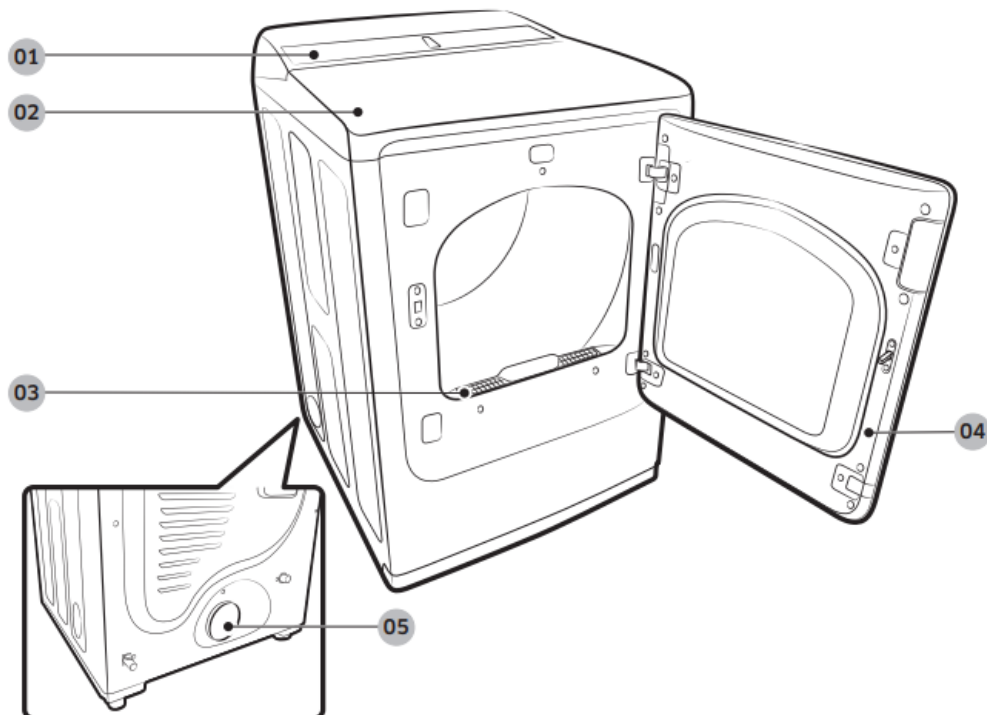





Dryer at a glance

1. Control panel
2. Worktop
3. Filter
4. Door
5. Exhaust duct

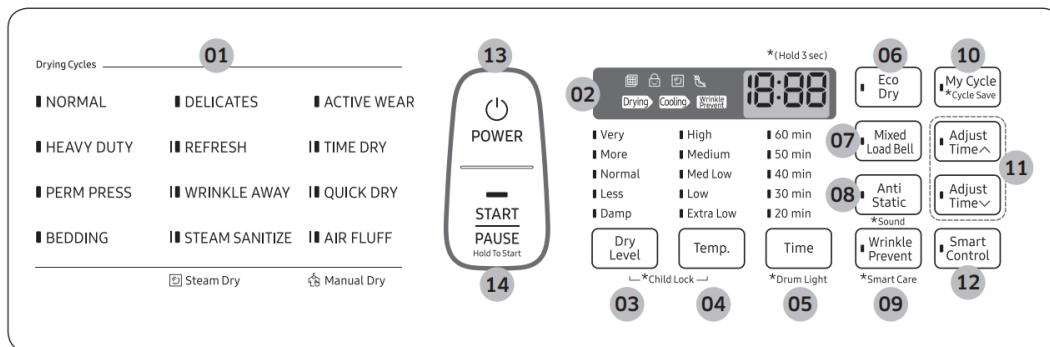
Operations



Feature panel



<p>01 Cycle Selector</p>	<p>Press to select a desired cycle in the left-most panel. When a cycle is selected, the cycle indicator lights up.</p> <ul style="list-style-type: none"> • Sensor Dry cycles: The dryer senses the internal humidity that will be applied to the drying time. This category includes: NORMAL, HEAVY DUTY, PERM PRESS, BEDDING, DELICATES, and ACTIVE WEAR. • Steam Dry cycles: The dryer sprays water into the drum to deodorize clothes and reduce static electricity and wrinkles. This category includes REFRESH, WRINKLE AWAY, and STEAM SANITIZE. • Manual Dry cycles: The drying time is fixed. This category includes: TIME DRY, QUICK DRY, and AIR FLUFF.
<p>02 Digital Graphic Display</p>	<p>Displays all cycle information, including the cycle time, information code, and operating status.</p> <ul style="list-style-type: none">  Filter Check  Child Lock  Steam  Vent Sensor

<p>03 Dry Level</p>	<p>Press Dry Level to select a dry level from the options available. The corresponding indicator light turns on.</p> <ul style="list-style-type: none"> • Larger or bulkier loads may require Very Dry or More Dry for complete dryness. • Less Dry is best suited for lightweight fabrics or for leaving some moisture in clothing at the end of the cycle. • Damp Dry is designed to partially dry items. Use for items that lay flat or hang to dry. <p>NOTE</p> <p>This option is not available with: STEAM SANITIZE, ACTIVE WEAR, TIME DRY, QUICK DRY, AIR FLUFF, REFRESH, and WRINKLE AWAY.</p>
<p>04 Temp.</p>	<p>Press Temp. to change the temperature of the current cycle.</p> <ul style="list-style-type: none"> • High: For sturdy cottons or those labeled Tumble Dry. • Medium: For permanent press, synthetics, lightweight cottons, or items labeled Tumble Dry Medium. • Med Low: For heat lower than Medium. Use to dry synthetic or washable fabrics. • Low: For heat sensitive items labeled Tumble Dry Low or Tumble Dry Warm. • Extra Low: Provides the lowest heated drying temperature possible.
<p>05 Time</p>	<p>Press Time to select a drying time for the selected cycle. This is available only with TIME DRY, QUICK DRY, AIR FLUFF, and WRINKLE AWAY.</p>
<p>06 Eco Dry</p>	<p>This function is available with NORMAL and TIME DRY.</p> <p>With the Eco Dry activated, drying takes a longer time but the power consumption is reduced.</p> <p>The drying time can be extended by up to 3 times depending on the temperature and humidity.</p> <p>The Eco Dry function is enabled by default.</p>
<p>07 Mixed Load Bell</p>	<p>The Mixed Load Bell notifies you when the average dry level in a load is damp dry (not fully dried). This lets you take items that you don't want fully dried or that dry quickly out of the dryer early while letting others continue to dry.</p> <p>You can select this option in all Sensor Dry cycle except for AIR FLUFF, ACTIVE WEAR, TIME DRY, QUICK DRY, REFRESH, WRINKLE AWAY, and STEAM SANITIZE. Available dry levels are Normal Dry, More Dry, and Very Dry.</p>



	<p>done by spraying steam in a later stage of the drying cycle.</p> <p>NOTE</p> <p>The Anti Static function is only available with NORMAL, HEAVY DUTY, PERM PRESS, DELICATES, and TIME DRY.</p>
09 Wrinkle Prevent	<p>Wrinkle Prevent provides approximately 180 minutes of intermittent tumbling in unheated air at the end of the cycle to reduce wrinkling. Press Wrinkle Prevent to activate this feature. The load is dry and can be removed at any time during the Wrinkle Prevent cycle.</p>
10 My Cycle	<p>Choose your favorite cycle including the cycle time, temperature, and dry level. See “My Cycle” for details.</p>
11 Adjust Time	<p>You can change the set time for the selected cycle. This is available only with TIME DRY, QUICK DRY, AIR FLUFF, and WRINKLE AWAY.</p> <p>To change the cycle time, press Adjust Time  or Adjust Time  until the desired time is displayed.</p>
12 Smart Control (Elec.) / Smart Monitor (Gas)	<p>After connecting the upper dryer to your home network using the Samsung Smart Home app, you can control the dryer remotely. When started, the Smart Control indicator blinks and the top door locks. The dryer enters waiting mode and waits for remote commands.</p>
13 POWER	<p>Press to turn on/turn off the dryer.</p>
14 START/PAUSE (Hold To Start)	<p>Press and hold to start operation, or press to stop operation.</p>

08 Anti Static	<p>Reduces static electricity that occurs from clothing friction. This is done by spraying steam in a later stage of the drying cycle.</p> <p>NOTE</p> <p>The Anti Static function is only available with NORMAL, HEAVY DUTY, PERM PRESS, DELICATES, and TIME DRY.</p>
09 Wrinkle Prevent	<p>Wrinkle Prevent provides approximately 180 minutes of intermittent tumbling in unheated air at the end of the cycle to reduce wrinkling. Press Wrinkle Prevent to activate this feature. The load is dry and can be removed at any time during the Wrinkle Prevent cycle.</p>
10 My Cycle	<p>Choose your favorite cycle including the cycle time, temperature, and dry level. See “My Cycle” for details.</p>
11 Adjust Time	<p>You can change the set time for the selected cycle. This is available only with TIME DRY, QUICK DRY, AIR FLUFF, and WRINKLE AWAY.</p>

NOTE Extremely tangled items finished by the washer may degrade the drying efficiency or cause the door to open. We recommend that you untangle the items before drying. Do not put objects on the dryer, especially on the feature panel

Simple steps to start

1. Press POWER to turn on the dryer.
2. Press to select a cycle in the left-most panel.
3. Change the cycle settings (Dry Level, Temp. and Time) as necessary.
4. Optionally, you can activate options available by pressing the relevant button (Anti Static, Mixed Load Bell, Wrinkle Prevent, and/or Eco Dry).
5. Press and hold START/PAUSE. The dryer indicator turns on with an estimated cycle time on the display.

To change the cycle during operation

1. Press START/PAUSE to stop operation.
2. Select a different cycle.
3. Press and hold START/PAUSE to start new cycle.

Cycle overview

Sensor Dry

Cycle	Description
NORMAL	For most fabrics including cottons and linens. If NORMAL is selected, the Eco Dry function is enabled by default. For more information, see Eco Dry in the “Feature panel” section.
HEAVY DUTY	For drying items made out of heavy fabrics, such as jeans, corduroys, or work clothes, with high temperature heat.
PERM PRESS	Dry wrinkle-free cottons, synthetic fabrics, knits, and permanent press fabrics automatically.
BEDDING	For bulky items such as blankets, sheets, and comforters.
DELICATES	For heat-sensitive items at a low drying temperature.
ACTIVE WEAR	For exercise wear and outdoor wear such as sports jerseys, training pants, water-repellent jackets, and other performance clothing. Thick fabrics like a zipper or velcro closure of a jacket, or training socks may not be completely dried.

Steam Dry

Cycle	Description
REFRESH	Use to smooth out wrinkles and reduce odors in loads of one to four items. With this cycle selected, a small amount of water is sprayed into the dryer drum after several minutes of tumbling with heat. Confirm that the laundry load is dry.
WRINKLE AWAY	For best results, load 2-3 items at once. You can extend the drying time by a minimum of 20 minutes, depending on the item type or load. Confirm that the laundry load is dry.
STEAM SANITIZE	Use to sanitize items by applying steam and high-temperature heat to the fabric. This cycle can make items soft and reduce smells. Confirm that the laundry load is wet or partially wet.

Manual Dry

Cycle	Description
TIME DRY	You can specify a cycle time in minutes. If TIME DRY is selected, the Eco Dry function is enabled by default. For more information, see Eco Dry in the “Feature panel” section.
QUICK DRY	A quick drying cycle running for 30 minutes
AIR FLUFF	Tumbles the load in room temperature air.

Drying guide

The best way to dry items is to follow the instructions on the care label. If no drying instructions are provided, see the following table for reference.

Cycle	Description
Bedspreads & Comforters	<p>Follow the care label instructions or dry using BEDDING.</p> <ul style="list-style-type: none"> • Make sure the item is thoroughly dry before using or storing. • May require repositioning in the drum to ensure even drying.
Blankets	<p>Use NORMAL and dry only one blanket at a time for best tumbling action.</p> <ul style="list-style-type: none"> • Make sure blankets are is thoroughly dry before using or storing.
Curtains & Draperies	<p>Use PERM PRESS and the Medium temperature setting to help minimize wrinkling.</p> <ul style="list-style-type: none"> • Dry curtains and draperies in small loads for best results and remove as soon as possible after the cycle is complete.
Cloth Diapers	<p>Use NORMAL and the Medium temperature setting for soft, fluffy diapers.</p>
Down-filled Items (jackets, sleeping bags, comforters, etc.)	<p>Use NORMAL and the Medium temperature setting.</p> <ul style="list-style-type: none"> • Add a couple of dry towels to absorb moisture and shorten drying time.
Foam Rubber (rug backs, stuffed toys, shoulder pads, etc.)	<p>Do not dry on a heat setting. Use AIR FLUFF.</p> <p>WARNING</p> <p>Drying a rubber item with heat may damage it or cause a fire.</p>
Pillows	<p>Use NORMAL.</p> <ul style="list-style-type: none"> • Add a couple of dry towels and a pair of clean sneakers to help the tumbling action and to fluff the pillows. • Do not dry kapok or foam pillows using a heated drying cycle. You can dry these items in the dryer only if you use AIR FLUFF.
Plastics (shower curtains, outdoor furniture covers, etc.)	<p>Use AIR FLUFF or TIME DRY and the Low or Extra Low temperature settings depending on the care label instructions.</p>



Special features

Child Lock

Child Lock prevents children from playing with the dryer. When Child Lock is activated, all buttons except for the POWER button are disabled.

To activate/deactivate Child Lock, simultaneously press and hold Dry Level and Temp. for 3 seconds.

NOTE

Once Child Lock is activated, it will remain active even after you restart the dryer. If other buttons, except for the POWER button, do not respond, check the Child Lock indicator. If the indicator is on, follow the instructions above to turn Child Lock off.

Drum Light

To turn on the drum light while the dryer is running, press and hold Time for 3 seconds.

NOTE

After 2 minutes of inactivity, the drum light automatically turns off.

To turn off the dryer's notification beeps and melodies, press and hold Anti Static for 3 seconds.

To unmute the dryer, press and hold Anti Static again for 3 seconds.

NOTE

This function remains active even after you restart the dryer.

My Cycle

You can create your own cycle that contains your preferred settings and use it at your convenience.

1. Press My Cycle to select a cycle. The cycle indicator turns on.
2. Set or change the settings (Dry Level, Temp., Time, etc) and/or options as necessary. Each corresponding indicator blinks.
3. Press and hold My Cycle for 3 seconds. The dryer stores the selected cycle with its settings.

To use My Cycle at a later time, simply press My Cycle.

NOTE

Wrinkle Prevent is not available with My Cycle.

Smart Care

If the dryer displays an information code, you can use Smart Care to check the status of the dryer on a smartphone. To use Smart Care, you must have the Samsung Smart Care app installed on your smartphone.

NOTE

If an information code appears on the dryer, follow these steps:

1. Press and hold Wrinkle Prevent for 3 seconds to activate Smart Care. The Smart Care indicator turns on.
2. Open the Smart Care app on your smartphone.
3. Put the smartphone's camera close to the display of the dryer. The app automatically recognizes the information code, and displays suggestions on your smartphone.
4. If the smartphone fails to recognize the information code more than twice, type the information code manually into the Smart Care app.

CAUTION

- If light is reflected on the display of the dryer, the smartphone may not recognize the information code.
- If you hold the smartphone at an angle to the dryer's display, the smartphone may not recognize the information code. For best results, hold the smartphone so that the front of the panel and the smartphone are parallel or nearly parallel.
- After you use this function, the dryer will delete the record of the information code from its code log



This product is a smart dryer that supports the Samsung Smart Home service. The EZ setup (network setting) takes time depending on your network condition. For more information, visit www.samsung.com.

Samsung Smart Home

Installation

Visit the Google Play Store, Galaxy Apps, or Apple App Store and search for "Samsung Smart Home". Download and install the Samsung Smart Home app provided by Samsung Electronics to your smart device.

NOTE

- The Samsung Smart Home app is designed for Android 4.0 (ICS) or higher, or iOS 8.0 or higher, and is optimized for Samsung smartphones (Galaxy S and Galaxy Note series).

- On other devices, some functions may operate differently.
- For improved performance, the Samsung Smart Home app is subject to change without notice.

Registering a Samsung account

To use the Samsung Smart Home app you must first sign in to your Samsung account. If you don't have a Samsung account select Register in the app, and then follow the onscreen instructions to create an account.

NOTE

- If you have a registered Samsung account, log into your Samsung account. If you have a Samsung smartphone, you can go to the Settings menu on your smartphone, select Accounts, and then sign in to your Samsung account. This will allow you to log in without additional authentication.
- For third-party smart phones, the app account must be the same as the Easy Setup account.

Getting started

With Samsung Smart Home, you can remotely control your dryer from your smart device. For improved performance, the content and design of the app is subject to change without notice.

1. Launch the Samsung Smart Home App on your smartphone.
 2. If 'Dryer' is not listed, tap Add Device > Select other device > Dryer on the app screen.
 3. Press and hold Smart Control on your dryer's control panel for more than 5 seconds until the 'AP' message appears on the display.
 4. When the device registration is complete, set the Smart Control available on your dryer. Now you can remotely control your dryer.
- For gas models, the Dryer app only serves as a monitoring device. You cannot manipulate any of the controls available on the app.

Maintenance

Vent sensor

The dryer features a vent sensor that detects and notifies you when it is time to clean the ductwork. The  indicator lets you know the status of the duct.

Level	 Indicator	Status	Action
0	Off	The ductwork is not clogged.	
1	On	<ul style="list-style-type: none"> The duct or lint filter is clogged. The pressure applied to the duct is high because the duct is too long or bent. 	<ul style="list-style-type: none"> Check the lint filter or duct and clean if necessary. Check the duct connections and shorten or straighten the duct if necessary.
2	Blinking	<ul style="list-style-type: none"> The duct or lint filter is severely clogged. The pressure applied to the duct is very high because the duct is too long or bent. 	<ul style="list-style-type: none"> Check and clean the lint filter or duct and make sure they are not clogged. Check the duct connections and shorten or straighten the duct work.

If the dryer is in the Level 2 state, the  indicator blinks for 3 hours after the completion of the current cycle. If you press POWER or open the door, the dryer powers off immediately.

NOTE

- For duct installation, see “Exhaust ducting guide”.
- The dryer may keep running even if the duct is clogged, but the drying time will be extended.
- If the indicator turns on for the first time and is solid (not blinking), check and clean the lint filter and/or duct.
- If the indicator turns on again later, it is because the duct is installed or connected with some restrictions (it’s too long or has too many bends). This is not a system failure. However, drying time may be extended or the drying performance may be degraded.

Cleaning

Feature panel

- Clean with a soft, damp cloth. Do not use abrasive substances.
- Do not spray liquid cleaning agents directly on the display of the dryer.
- Some laundry pre-treatment soil and stain removers may damage the feature panel.
- When using liquid cleaning agents, apply them to the cleaning cloth. Do not apply them directly to the dryer. Wipe up any spills or overspray immediately.

Tumbler

- Remove any stains from the tumbler with an all-purpose cleaner.

Tumble old towels or rags to remove any remaining stains or cleaning substances. Stains may still be visible, but will not affect subsequent loads.

Stainless steel tumbler

To clean the stainless steel tumbler, use a damp cloth with a mild, non-abrasive cleaner suitable for easily marred surfaces. Remove cleaner residue and dry with a clean cloth.

Dryer exterior

- Clean with a soft, damp cloth. Do not use abrasive substances.
- Protect the surface from sharp objects.
- Do not place any heavy or sharp objects or a detergent container on the dryer. They can scratch or damage the top cover of the dryer.
- The dryer has a high-gloss finish on the entire surface. Be careful not to scratch or damage the surface.

Exhaust system

- Check and clean the exhaust system on a yearly or regular basis to maintain optimum performance.
- The external exhaust hood must be cleaned more frequently to ensure a proper air flow.

Troubleshooting

Checkpoints

If the dryer operates abnormally, first check the list of problems in the table below and try the suggested actions

Problem	Action
Does not run.	<ul style="list-style-type: none"> • Make sure the door is latched shut. • Make sure the power cord is plugged into a live electrical outlet. • Check your home's circuit breakers or fuses. • Press or tap START/PAUSE again if the door is opened during a cycle. • Clean the lint filter.
Does not heat.	<ul style="list-style-type: none"> • Check your home's circuit breakers or fuses. • Some cycles do not require heating. Check the selected cycle again. • For a gas dryer, make sure the gas supply is on. • Clean the lint filter and exhaust duct. • The dryer may have moved into the cool-down phase of the cycle.
Does not dry.	<ul style="list-style-type: none"> • Check all of the above, plus... • Make sure the exhaust hood outside your home can open and close freely. • Check the exhaust system for lint buildup. Ducting should be inspected and cleaned annually. • Use a 4" rigid metal exhaust duct. • Do not overload. 1 wash load = 1 dryer load. • Dry heavy items and light weight items separately. • Large, bulky items, such as blankets or comforters, may require repositioning to ensure even drying. • Make sure that your washer is draining properly and extracting adequate water from the load. • The load may be too small to tumble properly. Add a few towels and restart the dryer. • The load may be too large to tumble properly. Remove some items and restart the dryer. • Clean the lint filter.



Is noisy.	<ul style="list-style-type: none"> • Check the load for objects such as coins, loose buttons, nails, etc. Remove promptly. • It is normal to hear the dryer gas valve or heating element cycle on and off during the drying cycle. • Make sure the dryer is leveled properly as outlined in the installation instructions. • It is normal for the dryer to hum due to the high velocity of air moving through the dryer drum, fan, or exhaust system.
Dries unevenly.	<ul style="list-style-type: none"> • Seams, pockets, and other similarly heavy areas may not be completely dry when the rest of the load has reached the selected dryness level. This is normal. You can choose a higher dryness level or a cycle that involves a higher dryness level. • If one heavy item is dried with a light weight load, such as one towel with sheets, it is possible that the heavy item will not be completely dry when the rest of the load has reached the selected dryness level. • For the best drying results, dry heavy items and light weight items separately.
Has odors.	<ul style="list-style-type: none"> • Household odors from paint, varnish, strong cleaners, etc. may enter the dryer with the surrounding room air. This is normal as the dryer draws the air from the room, heats it, pulls it through the tumbler, and exhausts it outside. • When these odors linger in the air, completely ventilate the room before using the dryer. • Use a cycle featuring the Refresh function. If odors persist, wash and dry the items again.
Lint on clothes.	<ul style="list-style-type: none"> • Make sure the lint filter is cleaned before every load. For clothes that naturally build up lint, clean the filter during the cycle. • Some fabrics are lint producers (for example, a fuzzy white cotton towel) and they must be dried separately from clothes that are lint trappers (for example, a pair of black linen pants). • Divide larger loads into smaller loads for drying. • Check pockets thoroughly before drying, then dry clothes. • Remove lint inside the drum before drying.



Information codes

If the dryer fails to operate, you may see an information code on the display panel. To determine what you should do, check the list of codes in the table below, and then try the suggested actions.



Code	Action
dC	<p>Operating the dryer with the door open.</p> <ul style="list-style-type: none"> • Make sure the door is properly closed. • Make sure laundry is not caught in the door.
FC	<p>Invalid power source frequency • Try restarting the cycle.</p> <ul style="list-style-type: none"> • If this information code remains, contact a Samsung service center.
AC	<p>Electronic control problem (Invalid Communication).</p> <ul style="list-style-type: none"> • Contact a Samsung service center.
HC	<p>High temperature heating check</p> <ul style="list-style-type: none"> • Clean the lint filter. • If this information code remains, contact a Samsung service center.(enter the line test mode)
9C1	<p>The electronic control needs to be checked.</p> <ul style="list-style-type: none"> • Check if power is supplied properly. • If the information code remains, contact a Samsung service center.
tC	<p>The Thermistor1 resistance is very low or high.</p> <ul style="list-style-type: none"> • Check for a clogged lint screen • Check if the vent system is restricted. • If this information code remains, contact a Samsung service center.
tC5	<p>The Thermistor2 resistance is very low or high.</p> <ul style="list-style-type: none"> • Check for a clogged lint screen. • Check if the vent system is restricted. • If this information code remains, contact a Samsung service center.
dF	<p>Incorrect door switch.</p> <ul style="list-style-type: none"> • Contact a Samsung service center.

If any information code keeps appearing on the screen, contact a Samsung service center.

Warning

This content is compiled from multiple sources and is provided for reference purposes only. It may not be complete or fully applicable to all situations. If you are unable to resolve your issue, please contact the product manufacturer or an authorized service provider for official support.

Document generated by [ManualsFile](#)