

INSTALLATION

Accessories

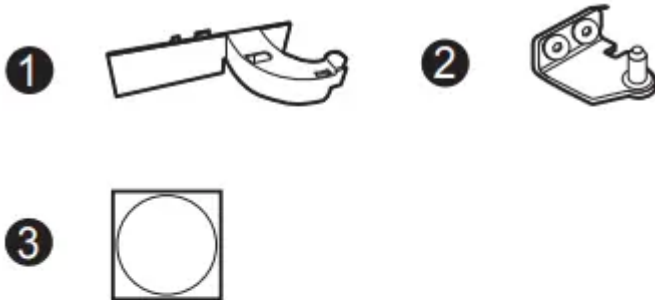

- ① Hinge cover
- ② Lower hinge
- ③ Sticker

Reversing Doors

Your appliance is designed with reversible doors, so that they may open from either the left or right hand side to suit your kitchen design.

NOTE

·Reversing the doors must be performed by the qualified personnel of LG Electronics. If not, the doors will not be covered by the warranty.

Leveling the Appliance

To avoid vibration, the unit must be leveled.

If required, adjust the leveling screws to compensate for the uneven floor.

The front should be slightly higher than the rear to aid in door closing.

Leveling screws can be turned easily by tipping the cabinet slightly.

Turn the leveling screws counterclockwise  to raise the unit, clockwise  to lower it.

Connecting the Appliance

After installing the appliance, connect the power plug into a socket outlet.

NOTE

·After connecting the power supply cord (or plug) to the outlet, wait 2 or 3 hours before you put food into the appliance. If you add food before the appliance has cooled completely, your food may spoil.

Moving the Appliance

1. Remove all food from inside the appliance.
2. Pull the power plug out, insert and fix it into the power plug hook at the rear or on top
After installing the appliance, connect the power plug into a socket out to switch on the appliance.
3. Tape parts such as shelves and the door handle to prevent from falling off while moving the appliance.
4. Move the appliance with more than two people carefully. When transporting the appliance over a long distance, keep the appliance upright.
5. After installing the appliance, connect the power plug into a socket out to switch on the appliance.

OPERATION

Parts and Functions

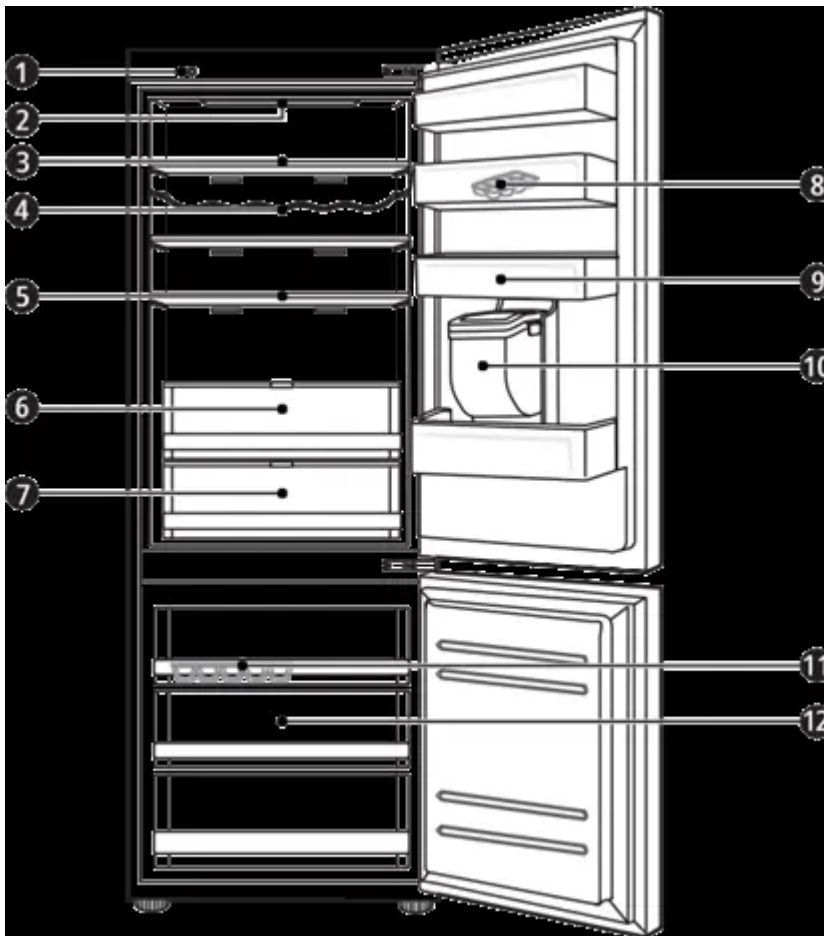

1. Smart Diagnosis Unit (*)

This function is used when contacting LG Electronics customer information centre to help make an accurate diagnosis when the appliance operates abnormally or a failure occurs.

2. LED Lamp

The LED lamps inside the appliance light up when you open the door.

3. Fridge Shelf

This is where refrigerated foods and other items are stored.

- The shelf height can be adjusted by inserting the shelf in another groove of different height.
- Store the foods with higher moisture content at the front of the shelf.
- The actual number of shelves will differ from model to model.

4. Bottle Rack (*)

This is where drinks tall bottles or containers are stored.

5. Folding Shelf (*)

This is where refrigerated foods and high items are stored.

6. Fresh Vegetable Drawer (*)

This is where fruits and vegetables are stored to help maintain freshness by adjusting the humidity controller.

- The appearance or components of the appliance may differ from model to model.

7. Fresh Converter (*)

As a chill compartment, this is where meat, fish and vegetables are stored. Help maintain freshness by adjusting the humidity controller located in the back of the fridge compartment.

- For more space, you can use chill area without chill compartment drawer.

8. Movable Egg Tray

This is where eggs are stored.

- You can move it to and use it at a desired position as needed. However, do not use it as the ice bin or place it on the shelf on top of the fridge or the vegetables drawer.

9. Fridge Door Basket

This is where small packages of refrigerated foods, drinks and sauce containers are stored.

10. Water Dispenser Tank (*)

This is where water to supply the dispenser or the automatic icemaker is stored. It requires manual filling. (Non plumbed models only)

11. Ice Tray

This is where ice is produced and stored.

- For more space, you can remove the ice tray or ice cubes bucket.

12. Freezer Drawer

This is for long-term storage of frozen items.

CAUTION

- Do not store short bottles or containers on the bottle rack. The items may fall and cause an injury or appliance damage.

NOTE

·(*) : This feature varies depending on the model purchased.

Notes for Operation

- Users should keep in mind that frost can form. If the door is not closed completely, if the humidity is high during the summer, or if the freezer door is opened frequently.
- Ensure there is sufficient space between food stored on the shelf or door basket to allow the door to close completely.
- Opening the door for long periods can cause a significant increase of the temperature in the compartments of the appliance.
- If the refrigerating appliance is left empty for long periods, switch off, defrost, clean, dry, and leave the door open to prevent mould developing within the appliance.

Suggestion for Energy Saving

- Ensure there is sufficient space between stored foods. This allows cold air to be circulated evenly and lowers electricity bills.
- Store hot food only after it has cooled in order to prevent dew or frost.
- When storing food in the freezer compartment, set the freezer temperature lower than the temperature indicated on the food.
- Do not put food near the temperature sensor of the fridge compartment. Keep a distance of at least 3 cm from the sensor.
- Note that a temperature rise after defrosting has a permissible range in the appliance specifications. If you wish to minimise the impact this may have on the food storage due to a temperature rise, seal or wrap the stored food in several layers.
- The automatic defrosting system in the appliance ensures that the compartment remains free of ice buildup under normal operating conditions.

Storing Foods Effectively

- Store frozen food or refrigerated food inside sealed containers.
- Check the expiration date and label (storage instructions) before storing food in the appliance.
- Do not store food for a long period of time (more than four weeks) if it spoils easily at a low temperature.
- Place the refrigerated food or frozen food in each fridge or freezer compartment immediately after purchasing.
- Store raw meat and fish in suitable containers in the refrigerator, so that it is not in contact with or drip onto other food.
- Avoid refreezing any food which has been completely thawed. Freezing any food which has been completely thawed again will lower its taste and nutrition.

- Do not wrap and store vegetables with newspaper. Printing material of newspaper or other foreign substances may smear and contaminate food.
- Do not overfill the appliance. Cold air can not circulate properly if the appliance is overfilled.
- If you set an excessively low temperature for food, it may become frozen. Do not set a temperature lower than the required temperature for the food to be stored correctly.
- For more space, you can remove bottle rack, egg tray, ice tray and fresh converter drawer.

Max Freezing Capacity

- The Express Freeze function will set the freezer to its maximum freezing capacity. This generally takes up to 24 hours and automatically switches off.
- If the maximum freezing capacity is to be used, Express Freeze must be switched on for seven hours before fresh produce is placed in the freezer compartment.

Maximum Storage

- To get better air circulation, insert all drawers.
- If large quantities of food are to be stored, all the freezer drawers shall be taken out of the appliance and the food shall be stacked directly on the freezer shelves in the freezer compartment.

NOTE

- To remove the drawers, first pick the food out of drawers. Then use the handle of drawers, pull out the drawers carefully. It may cause injury.
- The shape of each drawer may be different, insert in the right position.

Control Panel

Units and Functions

<Type 1> On the Refrigerator Door

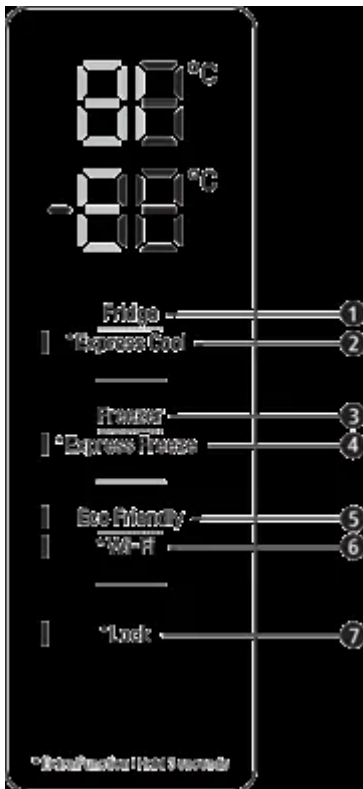

<Type 2> Inside the Refrigerator



1. Fridge Temperature

- This sets the fridge target temperature.

2. * Express Cool

- This sets the Express Cool Functions.

3. Freezer Temperature

- This sets the freezer target temperature.

4 * Express Freeze

- This sets the Express Freeze Functions.

5. Eco Friendly

- This controls the Power Save mode for lowering energy consumption.

6. * Wi-Fi

- This sets the refrigerator to connect to your home's Wi-Fi network.



7. * Lock

- This locks the buttons on the control panel.

NOTE

- The actual control panel may differ from model to model.
- The control panel will turn off automatically for energy saving.
- If there is any finger or skin contacts to the control panel while cleaning it, the button function may operate.

Setting the Temperature

This sets the fridge temperature or freezer temperature.

- Press the **Fridge** button or **Freezer** button to adjust the temperature.
- The temperature can be adjusted.
 - Fridge : from 1 °C to 7 °C
 - Freezer : from -15 °C to -23 °C
- The initial temperature is set.
 - Fridge : 3 °C
 - Freezer : -18 °C

The actual inner temperature varies depending on the food status, as the indicated setting temperature is a target temperature, not actual temperature within the appliance.

NOTE

- The default temperature setting may vary depending on the appliance.
- Wait until 2 or 3 hours have passed after connecting the appliance to the outlet before storing food in the appliance.
- For ice making in normal climates, the freezer temperatures should be set to -18 °C or colder.

Setting Express Freeze

The function can quickly freeze a large amount of ice or frozen foods.

- When you press and hold the **Express Freeze** button for three seconds, the **Express Freeze** icon lights on the control panel.
- The function is enabled and disabled in turn each time you press the button.
- The Express Freeze function automatically terminates after a specific period has passed.

NOTE

- When **Express Freeze** is switched on, noise may occur and energy consumption may increase.

Setting Express Cool

The function can quickly cool a large amount of foods such as vegetable, fruit and so on.

- When you press and hold the **Express Cool** button for three seconds, the **Express Cool** icon lights on the control panel.
- The function is enabled and disabled in turn each time you press the button.
- The Express Cool function automatically terminates after a specific period has passed.

NOTE

- When **Express Cool** is switched on, noise may occur and energy consumption may increase.

Setting Eco Friendly

- The function makes the fridge-freezer work in the power saving mode which is useful when you are away on a holiday as it reduces energy consumption.
- Pressing the **Eco Friendly** button starts the operation with the lamp on, and pressing it again stops the operation.
- When the Eco Friendly mode is on, the other buttons will not operate. When you finish using the Eco Friendly mode, turn it off so that other buttons work and the refrigerator returns to its previous temperature setting.

Setting and Resetting Lock

This locks the buttons on the control panel.

- Press and hold the **Lock** button for three seconds. When the Lock function is set, all buttons are locked.

NOTE

- You must deactivate Lock function before you can access any other functions.

High Temperature Alarm

When the freezer temperature goes too high due to power failure, the freezer temperature LED lamp blinks and an alarm sounds.

- Press **Freezer** button to stop.
- If the temperature is sufficiently cold, the blinking and alarm will automatically stop.

- This function operates:
 - When the refrigerator is turned on.
 - When the freezer compartment gets too warm.
 - When there is a power outage that lasts for a long period of time.
 - When large amounts of warm food are placed in the freezer compartment.
 - When the freezer door is left open for too long or too frequently.

Water Dispenser (*)

Press the lever 1 of the water dispenser to get cold water.



CAUTION

CAUTION

- Keep children away from the dispenser to prevent children playing with or damaging the controls.
- To clean the water dispensing system, flush the water through the dispenser about 5 minutes.

NOTE

- (*) : This feature varies depending on the model purchased.
- If you open the freezer door while water is being dispensed, the water supply will stop.
- If you open the fridge door while water is being dispensed, dispensing will be paused.
- If the cup rim is small, water may splash out of the glass or miss it completely.
- Use a cup with a rim of over 68 mm in diameter when dispensing water.

Water Dispenser Tank

1. Open the cap (small cover) on the top of the water tank.



2. Fill the water tank with potable water and close the cap (small cover).

The water tank can hold up to 2.3 L.

CAUTION

- Children should not be allowed near the dispenser tank. If the child drops the water dispenser tank while it is completely filled with water, injury may occur. Do not fill the water tank with drinks other than water or fill with hot water.
- Do not apply excessive force or impact when removing or assembling the water dispenser tank. Doing so can cause appliance damage or injury.

NOTE

- Before using the water dispenser tank after installing the appliance, it should be washed before filling it with water.
- Check if the water dispenser tank has been placed on the appliance correctly. If it is not assembled correctly, water may leak from the tank into the appliance.
- If there is no water in the water dispenser tank, the cold water function of the dispenser cannot be used. Check if there is water in the water dispenser tank and then fill it with water if there is not.
- Wait at least 15 seconds before removing the water tank after having dispensed water.
- Sound from the water tank will be normal when supplying water to the dispenser. It is not a sign of malfunction.

Ice Tray

Fill the ice tray with water.

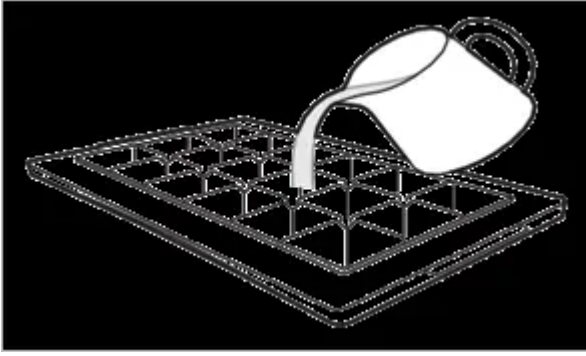

WARNING

- Fill with potable water only.

CAUTION

- Check whether there is any ice remaining in the ice tray before putting water into it.
- Do not slam the freezer door after filling the ice tray with water.
- If you open and close the freezer door frequently, it may take longer for the water to freeze.
- The time it takes for the water to freeze may vary according to the season.
- The temperature inside the appliance can take up to 24 hours to stabilize after initial installation. Water may take longer to freeze because of this.
- Be careful when handling the ice as the edges of the ice may be sharp.

NOTE

- If the ice tray is overfilled, the ice may stick together and be difficult to remove.
- Press the **Express Freeze** button on the control panel to make ice quickly.
- Do not store ice that has not frozen completely. Unfrozen water could cause the ice to clump together.
- Be careful not to use excessive force when twisting the ice tray. Doing so could break the ice tray.
- To easily remove ice, fill water up the tray in advance.

Fresh Converter (*)

As a chill compartment, the temperature in the fresh converter can be controlled by sliding the lever 1, where located in front of compartment, in either direction.

When keeping vegetables after setting up Meat or Fish, the cold injury may occur.

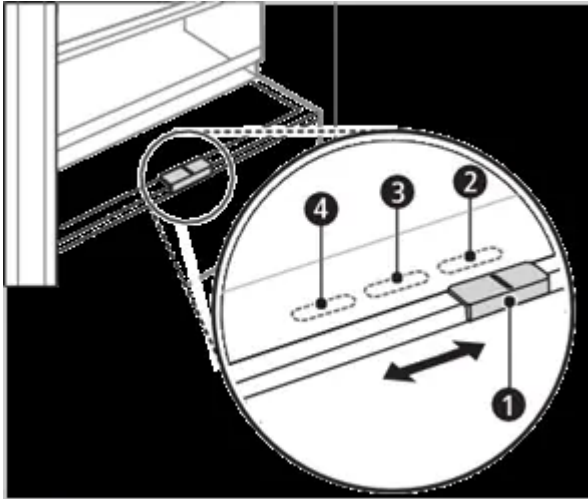

- 2. For storing vegetables.(Recommended)
- 3. For storing fish.
- 4. For storing meat.

NOTE

- (*) : This feature varies depending on the model purchased.

Fresh Vegetable Drawer (*)

Vegetable compartment can adjust the humidity by moving the knob 1 .

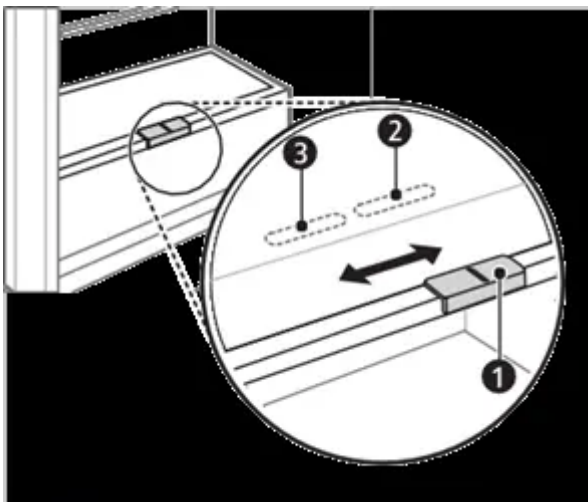

- 2. For storing vegetables.(Recommended)
- 3. For storing fruit.

NOTE

- (*) : This feature varies depending on the model purchased.



Folding Shelf

Store taller items, such as a gallon container or bottles, by pushing the front half of the shelf underneath the back half of the shelf. Pull the front of the shelf forward to return to a full shelf.

1. Lift the front side of the shelf and shift it on its back side.

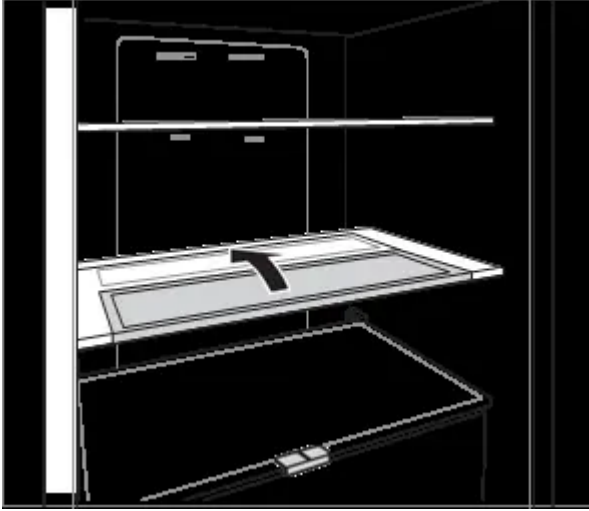

2. Lift the front side of the shelf and shift it under its back side. From this position, both sides of the shelf can be lifted up to free more space.

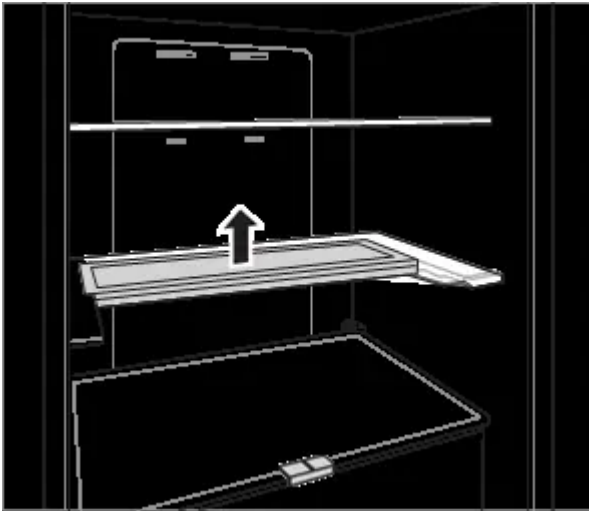

Other Functions

Door Open Alarm

The alarm sounds 3 times in a 30 seconds interval if the door (fridge compartment) is left open or not completely closed for one minute.

- Contact an LG Electronics customer information centre if the alarm sound continues even after closing the door.

Failure Detection

The appliance can automatically detect problems during the operation.

- If a problem is detected, the appliance does not operate and an error code is displayed even when any button is pressed.
- When this occurs, do not turn off the power and immediately contact an LG Electronics customer information centre. If you turn off the power, the repair technician from an LG Electronics customer information center may have difficulty finding the problem.

MAINTENANCE

Notes for Cleaning

- When removing a shelf or drawer from inside the appliance, remove all stored foods from the shelf or drawer to prevent injury or damage to the appliance.
 - Otherwise, injury may occur due to the weight of stored foods.
- If cleaning the outside air vents of the appliance by means of vacuuming, then the power cord should be unplugged from the outlet to avoid any static discharge that can damage the electronics or cause an electric shock.
- Detach the shelves and drawers and clean them with water, and then dry them sufficiently, before replacing them.
- Regularly wipe the door gaskets with a wet soft towel.
- Door basket spills and stains should be cleaned as they can compromise storage ability of the basket and could even be damaged.
- After cleaning, check if the power cable is damaged, warm or improperly plugged.
- Keep the air vents on the exterior of the appliance clean.
 - Blocked air vents can cause fire or appliance damage.
- For the appliance exterior, use a clean sponge or soft cloth and a mild detergent in warm water. Do not use abrasive or harsh cleaners. Dry thoroughly with a soft cloth.
- Never clean the shelves or containers in the dishwasher.
 - The parts may become deformed due to the heat.
- Clean regularly surfaces that can come in contact with food and accessible drainage systems.
- If the appliance is equipped with an LED lamp, do not remove lamp cover and LED lamp in any attempt to repair or service it. Please, contact an LG Electronics customer information centre.

Cleaning the Door Basket

Removing the Fridge Door Basket

Hold both edges of the basket and remove it by lifting it upward.

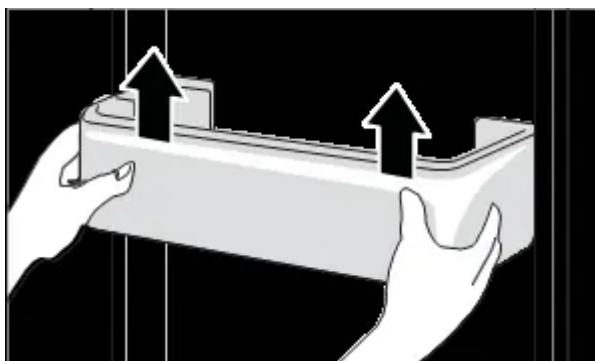

Refitting the Fridge Door Basket

1. Hold both edges of the door basket, gently push one edge to assemble, and then in the same manner assemble the other edge.

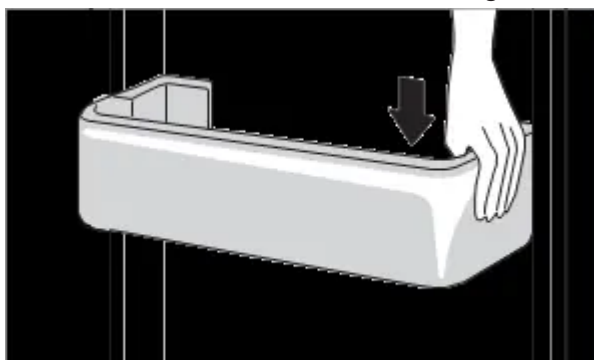

2. After assembling, tap the door basket gently to fix it horizontally.

Cleaning the Shelf

Removing the Fridge Shelf

Lift the rear edge of the fridge shelf and then pull it out.

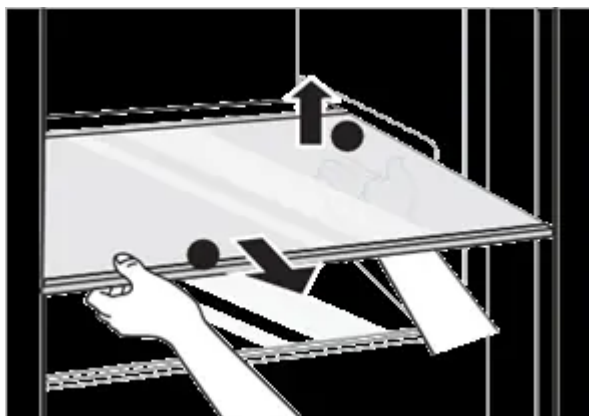

Refitting the Fridge Shelf

Refit the shelf in the reverse order of the removal process.

Cleaning the Vegetable Drawer

Removing the Vegetable Drawer

1. Remove the contents of the drawer. Hold the handle of the vegetable drawer and pull it out completely until it stops.
2. Lift the vegetable drawer up and remove it by pulling it out.

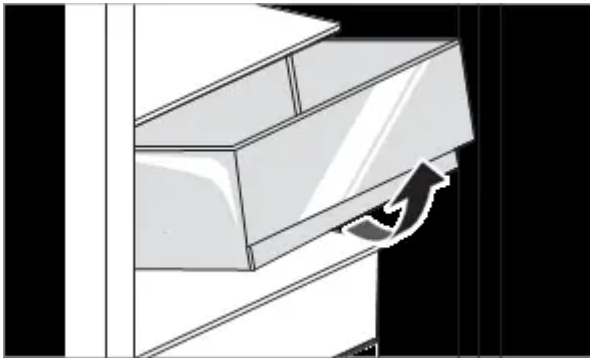

Refitting the Vegetable Drawer

Refit the vegetable drawer in the reverse order of the removal process.

Cleaning the Crisper Cover

Removing the Crisper Cover

1. After removing the vegetable drawer cover, pull the top section of the crisper cover down.

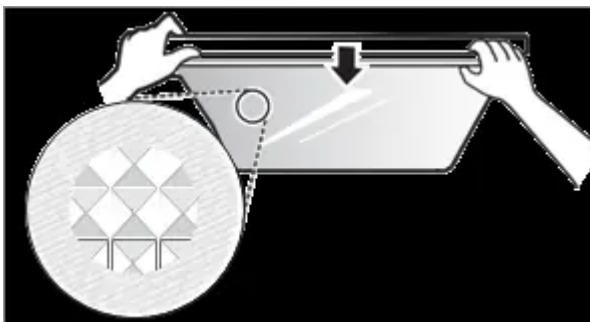

2. Remove the crisper cover by pulling it out.



Refitting the Crisper Cover

1. Place the protrusions inside the crisper cover on the grooves inside the shelf.

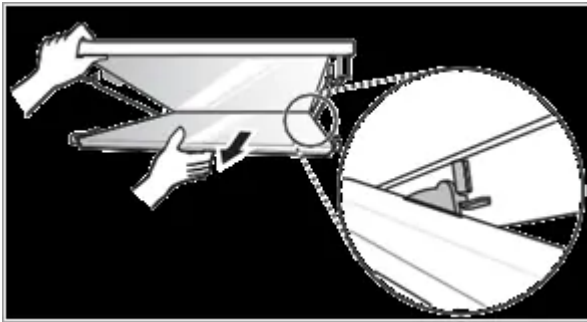

2. Insert the protrusions in front of the crisper cover into the grooves in front of the shelf and push the crisper cover up to assemble.

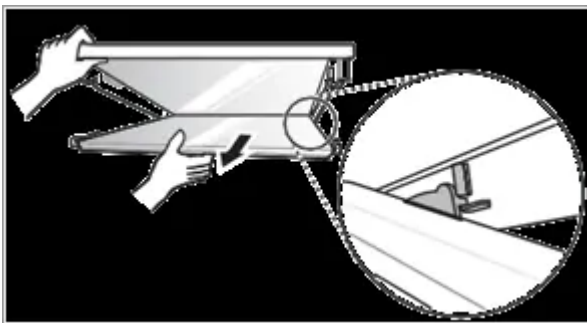

Cleaning the Freezer Drawer

1. Remove the contents of the drawer. Hold the handle of the freezer drawer and pull it out completely until it stops.
2. Lift the freezer drawer up and remove it by pulling it out.

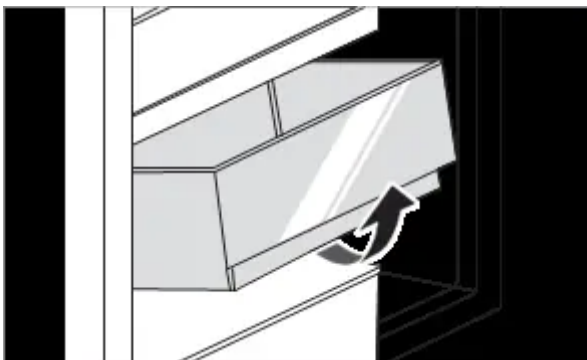

Refitting the Freezer Drawer

Refit the freezer drawer in the reverse order of the removal process.

Cleaning the Water Dispenser

Cleaning the Dispenser Tray

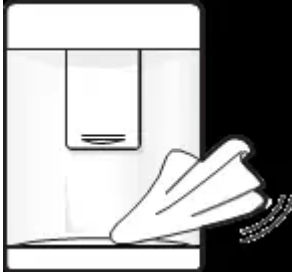

The dispenser tray may become wet easily due to spilled ice or water. Wipe the entire area with a damp cloth.

Cleaning the Water and Ice Outlet

Wipe the water or ice outlet frequently with a clean cloth as it may get dirty easily. Please note that lint from a cloth may adhere to the outlet.

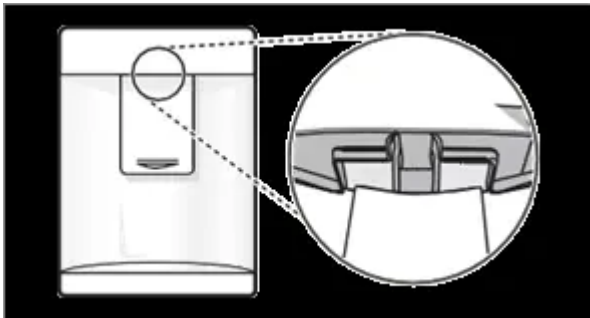

TROUBLESHOOTING



Symptoms	Reason&Solution
<p>There is no refrigeration or freezing.</p>	<p>Is there a power interruption?</p> <ul style="list-style-type: none"> • Check the power of other appliances.
	<p>If the power plug unplugged from the outlet?</p> <ul style="list-style-type: none"> • Plug the power plug in the outlet properly.
<p>There is poor refrigeration or freezing.</p>	<p>Is the fridge or freezer temperature set to its warmest setting?</p> <ul style="list-style-type: none"> • Set the fridge or freezer temperature to 'Medium'.
	<p>Is the appliance in direct sunlight, or is it near a heat generating object such as cooking oven or heater?</p> <ul style="list-style-type: none"> • Check the installation area and reinstall it away from heat generating objects.
	<p>Did you store hot food without cooling it first?</p> <ul style="list-style-type: none"> • Cool the hot food first before putting it in the fridge or freezer compartment.
	<p>Did you put in too much food?</p> <ul style="list-style-type: none"> • Maintain an appropriate space between food.
	<p>Are the appliance doors completely closed?</p> <ul style="list-style-type: none"> • Completely close the door and make sure that stored food is not obstructing in the door.
	<p>Is there enough space around the appliance?</p> <ul style="list-style-type: none"> • Adjust the installation position to make enough space around the appliance.
<p>The appliance contains a bad smell.</p>	<p>Is the fridge or freezer temperature set to 'Warm'?</p> <ul style="list-style-type: none"> • Set the fridge or freezer temperature to 'Medium'.



	<p>Did you put in food with a strong smell?</p> <ul style="list-style-type: none"> • Store foods with strong smells in sealed containers.
	<p>Vegetables or fruit may have spoiled in the drawer?</p> <ul style="list-style-type: none"> • Throw away rotten vegetables and clean the vegetable drawer. Do not store vegetables too long in the vegetable drawer.
<p>The inside lamp in the appliance does not turn on.</p>	<p>Does the inside lamp in the appliance turn off?</p> <ul style="list-style-type: none"> • It is hard for customers to replace the inside lamp in the appliance as they are not serviceable. If the inside lamp does not turn on, please contact the LG Electronics customer information centre.
<p>The appliance door is not closed tightly.</p>	<p>Is the appliance leaning forward?</p> <ul style="list-style-type: none"> • Adjust the front feet to raise the front side slightly.
	<p>Were the shelves properly assembled?</p> <ul style="list-style-type: none"> • Refit the shelves if needed.
	<p>Did you close the door with excessive force?</p> <ul style="list-style-type: none"> • If you apply too much force or speed when closing the door, it may remain briefly open before closing. Make sure that you do not slam the door closed. Close without force.



<p>It is difficult to open the appliance door.</p>	<p>Did you open the door right after you closed it?</p> <ul style="list-style-type: none"> • If you try to open the appliance door within one minute after you closed it, you may have difficulties because of the pressure inside the appliance. Try to open the appliance door again in a few minutes so that the internal pressure stabilizes.
<p>There is condensation inside the appliance or on the bottom of the vegetable drawer cover.</p>	<p>Did you store hot food without cooling it first?</p> <ul style="list-style-type: none"> • Cool the hot food first before putting it in the fridge or freezer compartment.
	<p>Did you leave the appliance door open?</p> <ul style="list-style-type: none"> • Although the condensation will disappear soon after you close the appliance door, you can wipe it with a dry cloth.
	<p>Do you open and close the appliance door too frequently?</p> <ul style="list-style-type: none"> • Condensation can form due to the temperature difference from the outside. Wipe out the dampness with a dry cloth.
	<p>Did you put warm or moist food inside without sealing it in a container?</p> <ul style="list-style-type: none"> • Store food in a covered or sealed container.
<p>Frosts has formed in the freezer compartment.</p>	<p>Doors may not be closed properly?</p> <ul style="list-style-type: none"> • Check if the food item inside the appliance is blocking the door and make sure that the door is tightly closed.
	<p>Did you store hot food without cooling it first?</p> <ul style="list-style-type: none"> • Cool the hot food first before putting it in the fridge or freezer compartment.



Frosts has formed in the freezer compartment.	Is the air entry or exit of the freezer compartment blocked? <ul style="list-style-type: none"> • Make sure that air entry or exit is not blocked so that the air can circulate inside.
	Is the freezer compartment overfilled? <ul style="list-style-type: none"> • Maintain an appropriate space between items.
Frost or condensation has formed inside or outside the appliance.	Did you open and close the appliance door frequently or is the appliance door improperly closed? <ul style="list-style-type: none"> • Frosts or condensation can form if the outside air penetrates inside the appliance.
	Is the installation environment humid? <ul style="list-style-type: none"> • Condensation can appear on the exterior of the appliance if the installation area is too humid or on a humid day such as a rainy day. Wipe off any moisture with a dry cloth.

<p>The appliance is noisy and generates abnormal sounds.</p>	<p>Is the appliance installed on a weak floor or improperly leveled?</p> <ul style="list-style-type: none"> • Install the appliance on a solid and flat area.
	<p>Does the rear of the appliance touch the wall?</p> <ul style="list-style-type: none"> • Adjust the installation position to allow enough clearance around the appliance.
	<p>Are objects scattered behind the appliance?</p> <ul style="list-style-type: none"> • Remove the scattered objects from behind the appliance.
	<p>Is there an object on top of the appliance?</p> <ul style="list-style-type: none"> • Remove the object on top of the appliance.
<p>The side or front of the appliance is warm.</p>	<p>There are anti condensation pipes fitted to these areas of the appliance to reduce condensation forming from around the door area.</p> <ul style="list-style-type: none"> • The heat releasing pipe to prevent condensation is installed on the front and side of the appliance. You may feel it particularly hot right after the appliance is installed or during the summer. You can be assured that this is not a problem and is quite normal.
<p>There is water inside or outside of the appliance.</p>	<p>Is there water leakage around the appliance?</p> <ul style="list-style-type: none"> • Check if the water has leaked from a sink or another place.
	<p>Is there water on the bottom of the appliance?</p> <ul style="list-style-type: none"> • Check if the water is from the thawed frozen food or a broken or dropped container.
<p>Clicking noises</p>	<p>The defrost control will click when the automatic defrost cycle begins and ends. The thermostat control (or</p>

	<p>appliance control on some models) will also click when cycling on and off.</p> <ul style="list-style-type: none"> • Normal Operation
<p>Rattling noises</p>	<p>Rattling noises may come from the flow of appliance, the water line on the back of the unit (for plumbed models only), or items stored on top of or around the appliance.</p> <ul style="list-style-type: none"> • Normal Operation
	<p>Appliance is not resting evenly on the floor.</p> <ul style="list-style-type: none"> • Floor is weak or uneven or leveling legs need to be adjusted. See the Door Alignment section.
	<p>Appliance with linear compressor was moved while operating.</p> <ul style="list-style-type: none"> • Normal operation. If the compressor does not stop rattling after three minutes, turn the power to the appliance off and then on again.



Whooshing noises	Evaporator fan motor is circulating air through the fridge and freezer compartments. <ul style="list-style-type: none">• Normal Operation
	Air is being forced over the condenser by the condenser fan. <ul style="list-style-type: none">• Normal Operation
Gurgling noises	Appliance flowing through the cooling system <ul style="list-style-type: none">• Normal Operation
Popping noises	Contraction and expansion of the inside walls due to changes in temperature. <ul style="list-style-type: none">• Normal Operation
Vibrating	If the side or back of the appliance is touching a cabinet or wall, some of the normal vibrations may make an audible sound. <ul style="list-style-type: none">• To eliminate the noise, make sure that the sides and back do not make any contact with any wall or cabinet.
Your home appliance and smartphone is not connected to the Wi-Fi network.	The password for the Wi-Fi that you are trying to connect to is incorrect. <ul style="list-style-type: none">• Find the Wi-Fi network connected to your smartphone and remove it, then register your appliance on LG ThinQ
	Mobile data for your smartphone is turned on. <ul style="list-style-type: none">• Turn off the Mobile data of your smartphone and register the appliance using the Wi-Fi network.

The wireless network name (SSID) is set incorrectly.

- The wireless network name (SSID) should be a combination of English letters and numbers. (Do not use special characters.)

The router frequency is not 2.4 GHz.

- Only a 2.4 GHz frequency is supported. Set the wireless router to 2.4 GHz and connect the appliance to the wireless router. To check the router frequency, check with your Internet service provider or the router manufacturer.

The distance between the appliance and the router is too far.

- If the distance between the appliance and the router is too far, the signal may be weak and the connection may not be configured correctly. Move the location of the router so that it is closer to the appliance.

Warning

This content is compiled from multiple sources and is provided for reference purposes only. It may not be complete or fully applicable to all situations. If you are unable to resolve your issue, please contact the product manufacturer or an authorized service provider for official support.

