

Getting to know your appliance

Getting to know your appliance Diagrams of the control panel and the interior of the appliance can be found in the envelope at the front. Individual positions are referred to in the text.

Control panel

- 1** ON/OFF switch
- 2** Door opener
- 3** Programme selector
- 4** START button
- 5** Digital display
- 6** Timer programming *
- 7** Additional options **
- 8** Rinse aid refill indicator
- 9** Display "Check water supply"

* depending on model

** Number depending on model

Appliance interior

- 20** Top basket
- 21** Knife shelf *
- 22** Tablet collecting tray
- 23** Top spray arm
- 24** Bottom spray arm
- 25** Filters
- 26** Cutlery basket
- 27** Bottom basket
- 28** Dispenser for rinse aid
- 29** Detergent dispenser

30 Lock for detergent dispenser

31 Rating plate

* depending on model



Rinse aid

As soon as the rinse-aid refill indicator **8** is lit on the fascia, there is still a rinse-aid reserve of 1-2 rinsing processes. Refill with rinse aid. The rinse aid is required for stain-free utensils and clear glasses. Use only rinse aid for domestic dishwashers.

Combined detergents with rinse-aid component may be used up to a water hardness of 21° dH (37° fH, 26° Clarke, 3.7 mmol/l) only. If the water hardness is over 21° dH, rinse aid must be used.

1. Open the dispenser **28** by pressing and lifting the plate on the cover.

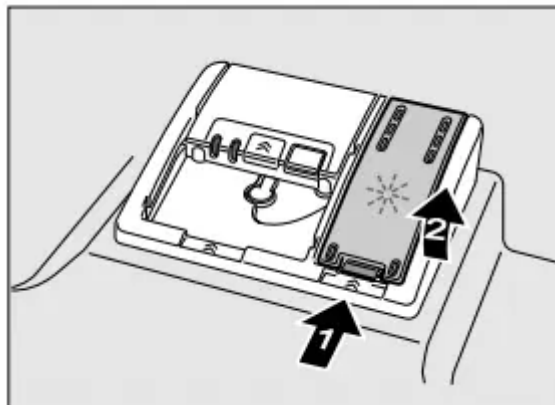

2. Carefully pour rinse aid up to the max. mark in the filler opening

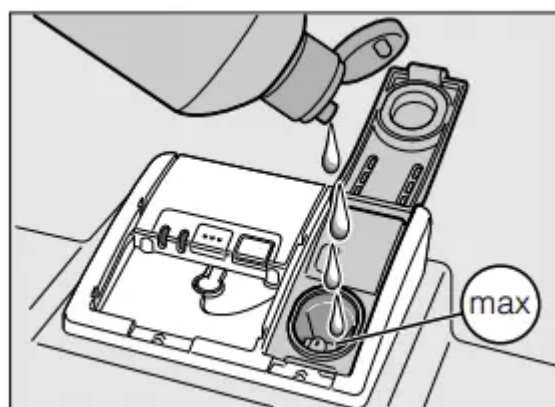

3. Close cover until it clicks shut.
4. To prevent excessive foam formation during the next rinse cycle, remove any rinse aid which has run over with a cloth.

Setting amount of rinse aid

The amount of rinse aid can be set from **r:00** to **r:06**. Please set rinse aid on **r:05** to obtain very good drying results (**r:05** is already set in factory). Change this setting, only if streaks (select lower setting) or water stains (select higher setting) are left on the utensils.

1. Close the door.
2. Switch on ON/OFF switch **1**.
3. Press and hold down the START button **4**.
4. Rotate programme selector **3** until **r:0** is indicated on the digital display **5**.
5. Release button. The factory set value **r:05** is lit on the digital display **5**.

To change the setting:

1. Rotate programme selector **3** until the required value is indicated on the digital display **5**.
2. Press START button **4**. The set value is saved.

Switching off rinse aid refill indicator

If the rinse-aid refill indicator **8** is impaired (e.g. when using combined detergents containing rinse aid component), it can be switched off.

- Proceed as described under “Setting amount of rinse aid” and set the value to **r:00**.

The rinse aid refill indicator **8** is now switched off.



Utensils

Not suitable

- Cutlery and utensils made of wood.
- Delicate decorative glasses, craft and antique utensils. These decors are not dishwasher-proof.
- Plastic parts not resistant to heat.
- Copper and tin utensils.
- Utensils which are soiled with ash, wax, lubricating grease or ink.

Aluminium and silver parts have a tendency to discolour and fade during the wash cycle. Even some types of glass (e.g. crystal glass objects) may turn cloudy after many wash cycles.

Glass and utensil damage

Causes:

- Glass type and glass production process.
- Chemical composition of the detergent.
- Water temperature of the wash programme.

Recommendation:

- Use only glasses and porcelain which the manufacturer designates as dishwasher-proof.
- Use a detergent which protects utensils.
- Take glass and cutlery out of the dishwasher as soon as possible after the programme ends.

Loading the dishwasher

1. Remove large food remnants. It is not necessary to prerinse utensils under running water.
2. Place the utensils so that
 - they are secure and cannot tip over.
 - all utensils with their openings face down.
 - parts with curves or indentations are at an angle, thereby allowing water to drain.
 - does not obstruct rotation of the two spray arms **23** and **24**.

Very small utensils should not be washed in the machine, as they may fall out of the baskets.

Unloading the dishwasher

To prevent water from dripping off the upper basket onto the utensils in the lower basket, it is recommended to empty the appliance from the bottom up.

Hot utensils are sensitive to shock! Therefore, when the programme ends, leave the utensils to cool down in the dishwasher until they can be handled.

Note When the programme ends, water droplets can still be seen inside the appliance. This does not affect the drying of the utensils.

Cups and glasses

Top basket **20**



Note Utensils must not be placed above the tablet collecting tray **22**. These may block the lid of the detergent dispenser and prevent it from opening fully

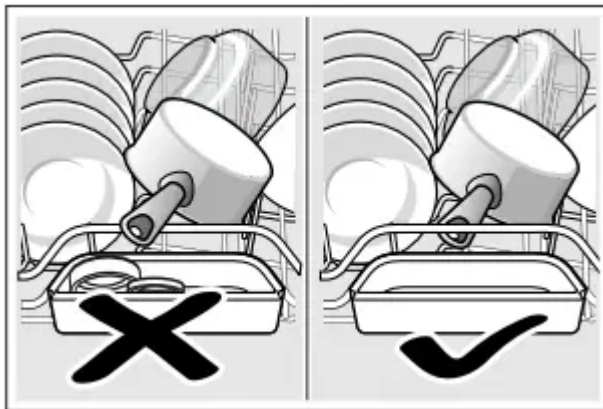

Pans

Bottom basket **27**

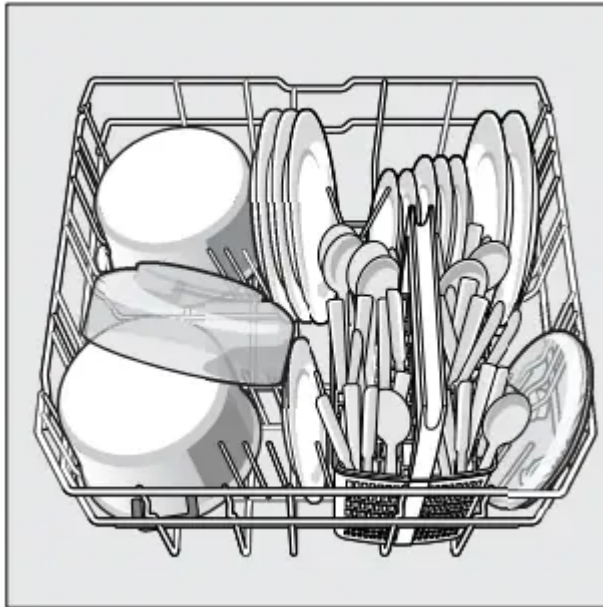

Tip

Heavily soiled utensils (pans) should be placed in the bottom basket. The more powerful spray jet provides a better dishwashing result.

Tip

Other examples, such as the best way of loading your dishwasher, can be found on our homepage as a free download. The corresponding Internet address can be found on the back page of these instructions for use.

Cutlery basket

You should always place cutlery unsorted with the points downwards. To prevent injuries, place long, pointed implements and knives on the knife shelf.

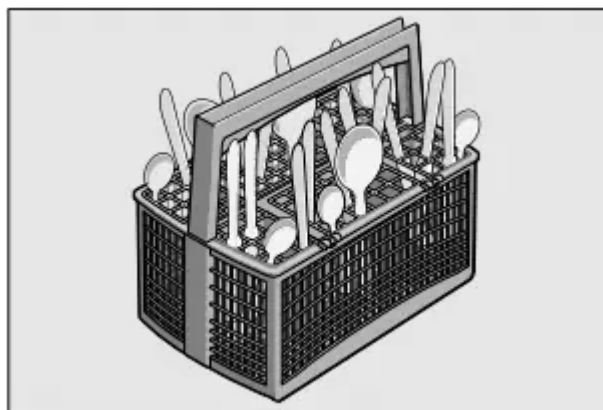

Etagere *

The etagere and the space underneath can be used for small cups and glasses or for larger items of cutlery, such as wooden spoons or serving cutlery. The etagere can be folded up if not required.



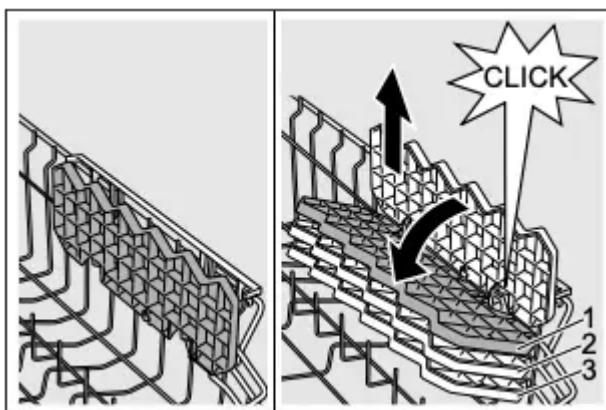

* Depending on the model, a 3-fold height adjustment is possible. To do this, first place the etagere vertically and pull up, then place at a slight angle, push down to the required height (1, 2, or 3) and snap into place.

Folding spikes *

* depending on model

The spikes can be folded down to improve arrangement of pans, bowls and glasses.

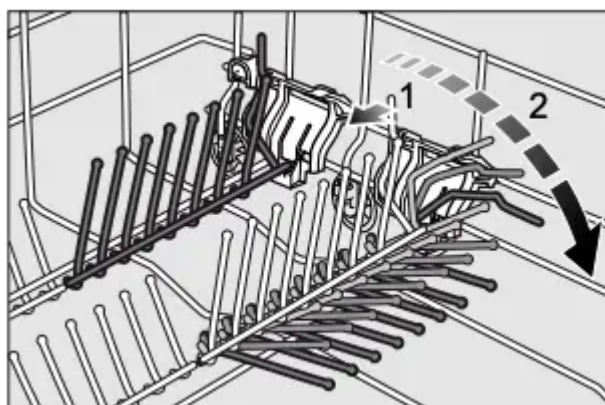

Small accessories holder *

* depending on model

Light-weight plastic accessories, e.g. cups, lids, etc. can be held securely in the small accessories holder.

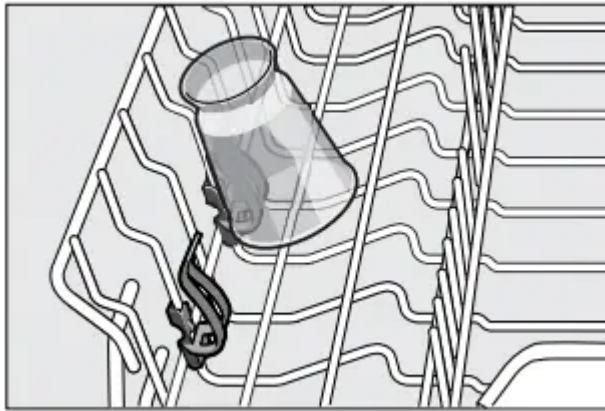

***Knife shelf**

* depending on model

Long knives and other utensils can be arranged horizontally

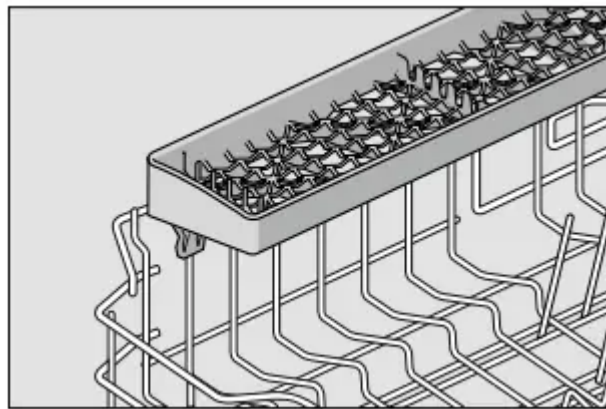

Adjusting the height of the basket *

* depending on model

If required, the height of the upper utensils basket 20 can be adjusted to provide more space for tall utensils either in the upper or lower basket.

Appliance height 81.5 cm

	Top basket	Bottom basket
Setting 1 max. ø	22 cm	30 cm
Setting 2 max. ø	24.5 cm	27.5 cm
Setting 3 max. ø	27 cm	25 cm

Appliance height 86.5 cm



	Top basket	Bottom basket
Setting 1 max. \emptyset	24 cm	33 cm
Setting 2 max. \emptyset	26.5 cm	30.5 cm
Setting 3 max. \emptyset	29 cm	28 cm

Select one of the two following procedures according to the design of the top basket for your appliance model.

Top basket with side levers

1. Pull out the top basket 20 out.
2. To lower the basket, press in the left and then the right lever on the outside of the basket. In doing so, hold the sides of the basket along the upper edge to prevent it from suddenly dropping.

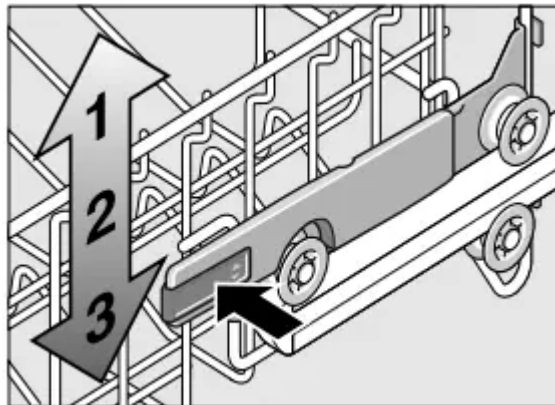

3. To raise the basket, hold the basket on the sides of the upper edge and lift it up.
4. Before re-inserting the basket again, ensure that it is at the same height on both sides. Otherwise, the appliance door cannot be closed and the upper spray arm will not be connected to the water circuit.

Top basket with upper and lower roller pairs

1. Pull out the top basket 20 out.
2. Remove the upper basket and reattach it to the upper (stage 3) or lower (stage 1) rollers.

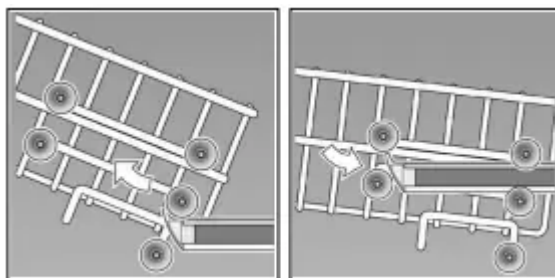

Detergent

You can use tablets as well as powder or liquid detergents for dishwashers, but never use washing-up liquid. The dosage can be individually adjusted with powder or a liquid detergent according to the degree of soiling. Tablets contain an adequately large amount of active ingredients for all cleaning tasks. Modern, powerful detergents predominantly use a low-alkaline formulation with enzymes. Enzymes break down starch and remove protein. To remove coloured stains (e.g. tea, ketchup), oxygen-based bleaching agents are generally used.

Note To ensure a good washing result, always follow the instructions on the detergent packaging! If you have further questions, we recommend that you contact the detergent manufacturers' helpline.

Warning – Read and observe the safety information and instructions for use on the packaging for cleaning and rinsing agents.

Adding detergent

1. If the detergent dispenser **29** is still closed, press the lock **30** to open the detergent dispenser.

Pour detergent into the dry detergent dispenser **29** only (insert tablet flat, not on its edge).

Dosage: see manufacturer's instructions on the packaging. The graduated detergent dispenser **29** helps you add the correct amount of powder or liquid detergent.

Usually 20 ml–25 ml are adequate for normal soiling. If using tablets, one tablet is adequate.

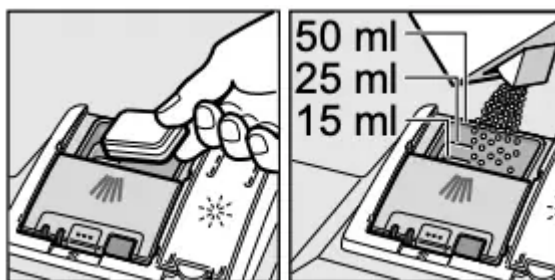

2. Close the cover on the detergent dispenser by sliding it up until the lock engages without difficulty.

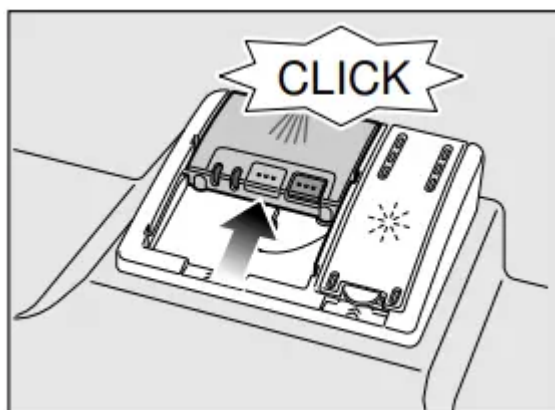

The detergent dispenser opens automatically at the optimum time depending on the programme. The powder or liquid detergent is distributed in the appliance and is dissolved, the tablet falls into the tablet collecting tray where it dissolves in doses.

Tip If the utensils are only lightly soiled, slightly less than the indicated amount of detergent is usually adequate. Suitable detergents and care products can be purchased online via our website or via customer service (see back page).

⚠ Warning – Do not place small parts for washing in the tablet collecting tray **22** this prevents the tablet from dissolving evenly.



⚠ Warning – If you want to add more utensils after the programme has started, do not use the tablet collecting tray **22** as a handle for the upper basket. The tablet could already be there and you will touch the partially dissolved tablet.

Notes

- If programmes are short, tablets may not have full cleaning effect due to different dissolving properties and there may even be undissolved detergent residue. It is recommended to use washing powder for these programmes.
- The Intensive programme (on some models) requires one tab only. When using washing powder, you can apply some of this cleaning agent to the inside of the appliance's door.
- If using detergents in a water-soluble protective cover: Take hold of the cover with dry hands only and put the detergent into an absolutely dry detergent dispenser only, otherwise the detergent may stick.
- If you switch from combined detergents to solo detergents, ensure that the water softening system and amount of rinse aid have been set to the correct value.

Overview of programmes

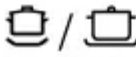
The max. possible number of programmes is illustrated in this overview. The corresponding programmes for your appliance can be found on the fascia. The programme data has been measured in the laboratory according to AS/NSZ 2007.

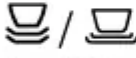
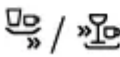
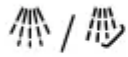
Type of utensils and soiling	Programm	Programme data 1.) Duration: hs/ mins 2.) Energy consumption in kWh 3.) Water consumption in litres 4.) With Aquasensor	Possible additional options	Programme sequence
Pots, utensils and cutlery Highly soiled	 Pots and Pans 70°	1.) 2:15 2.) 1,50 3.) 15 4.) 12	all	Prerinse Clean 70° Intermediate rinse Final rinse 70° Dry
	 intensive 65°	1.) 2:10 2.) 1,40 3.) 14 4.) -	all	Prerinse Clean 65° Intermediate rinse Final rinse 70° Dry
Utensils and cutlery Normally soiled	 Auto 45° - 65°	1.) 1:35-2:40 2.) 1,00-1,60 3.) - 4.) 9-19	all	Is optimised according to the soiling with the aid of sensors.
	 Normal 45°	1.) 2:20 2.) 0,73 3.) 13,5 4.) -	all	Prerinse Clean 45° Intermediate rinse Final rinse 45° Dry
Utensils and cutlery Lightly soiled	 Quick 45°	1.) 0:29 2.) 0,80 3.) 10 4.) -	Extra drying	Clean 45° Intermediate rinse Final rinse 55°
all types of utensils Lightly soiled	 Prerinse	1.) 0:15 2.) 0,05 3.) 4 4.) -	none	Cold rinse: Prerinse

Note The consumption figures depend on the selected programme and additional functions. The programme duration will be different if the machine is short of rinse additive or the function is turned off.

Programme selection

You can select a suitable programme according to the type of utensils and degree of soiling.

Information for test institutes

Test institutes can request the conditions for running comparison tests by sending an e-mail to dishwasher@test-appliances.com. Quote the appliance number (ENr.) and the production date (FD) which you can find on the rating plate  on the appliance door.

Additional options

* depending on model

Additional options can be set with the buttons .

Express Wash/ Speed Perfect/ (VarioSpeed) *

This function can reduce the running time by approx. 20% to 50% depending on the selected rinse programme. The change in the running time is indicated on the digital display . To obtain optimum cleaning results at a reduced running time, water and energy consumption are increased.

Half load *

If you have only a few items to wash e.g. glasses, cups, plates), you can switch to “half load”. This will save water, energy and time. It is recommended to put a little less detergent in the detergent dispenser than for a full load.

Hygiene *

The temperature is increased during the cleaning process. This increases the hygiene status. This additional option is ideal for cleaning e.g. chopping boards and baby bottles.

Intensive zone *

Perfect for a mixed load. You can wash very soiled pots and pans in the lower basket together with normally soiled utensils in the upper basket. The spray pressure in the lower basket is intensified, the rinsing temperature is increased slightly.

Extra drying *

An increased temperature during the final rinse and an extended drying phase ensure that even plastic parts dry better. There is a slight increase in the energy consumption



Operating the appliance

Aqua sensor *

* depending on model

The Aqua sensor is an optical measuring device (light barrier) which measures the turbidity of the rinsing water.

The Aqua sensor is used according to the programme. If the Aqua sensor is active, “clean” rinsing water can be transferred to the next rinse bath and water consumption can be reduced by 3–6 litres. If the turbidity is greater, the water is drained and is replaced with fresh water. In the automatic programmes the temperature and running time can also be adjusted to the degree of soiling.

Switching on the appliance

1. Turn on the tap fully.
2. Switch on ON/OFF switch **1** .
3. Rotate programme selector **3** to the required programme. The expected programme duration flashes on the digital display **5** .
4. Press START button **4** . The programme starts running.

Remaining running time display

When the programme is selected, the remaining running time of the programme is indicated on the digital display **5** . The running time is determined during the programme by the water temperature, the number of utensils as well as the degree of soiling and may vary (depending on the selected programme).

Timer programming *

* depending on model

You can delay the start of the programme in 1-hour steps up to 24 hours.

1. Close the door.
2. Switch on ON/OFF switch **1** .
3. Press button **6** until the digital display **5** jumps to **h:01** .
4. Press button **6** until the displayed time corresponds with your requirements.
5. Press START button **4** , timer programming is activated.

6. To delete the preselected starting time, press the button **6** until **h** is indicated on the digital display. You can change your programme selection at any time until the programme starts.

End of programme

The programme has ended when the value **0:00** is indicated on the numerical display **5**.

Switching off automatically after the end of the programme *

* depending on model

To save energy, the dishwasher is switched off 1 minute after the programme ends (factory setting). Automatic disconnection can be adjusted from **P:00** to **P:02**.

- **P:00** Appliance does not switch off automatically
- **P:01** Off after 1 min
- **P:02** Off after 120 min

1. Close the door.

2. Switch on ON/OFF switch **1**.

3. Press and hold down the START button **4**.

4. Rotate programme selector **3** until **P:0** ... s indicated on the digital display **5**.

5. Release button. The factory set value **P:01** is lit on the digital display **5**.

To change the setting:

1. Rotate programme selector **3** until the required value is indicated on the digital display **5**.

2. Press START button **4**. The set value is saved.

Switching off the appliance

Short time after the end of the programme:

1. Switch off ON/OFF switch **1**.



2. Turn off the tap (not applicable if Aqua-Stop fitted).

3. Open the door.







4. Remove the utensils when they have cooled down.

Note When the programme ends, leave the appliance to cool down a while before opening it. This will prevent steam from escaping and causing longterm damage to your built-in furniture.

Interrupting the programme

1. Switch off ON/OFF switch . The LEDs go out. The programme is saved. If the door was opened on an appliance which has a warm water connection or is heated, first leave the door ajar for several minutes and then close. Otherwise, expansion (pressure) may cause the appliance door to spring open or water to run out of the appliance.
2. To continue the programme, switch on the ON/OFF switch  again.

Terminating the programme (Reset)







1. Press START button  for approx. 3 sec. The numerical display  indicates .
2. The programme sequence lasts approx. 1 min. On the digital display  is indicated .
3. Switch off ON/OFF switch .

Changing the programme



When the START button  has been pressed, the programme cannot be changed. The only way a programme can be changed is by Cancel programme (Reset).

Intensive drying

The final rinse uses a higher temperature which improves the drying result. The running time may increase slightly. (Caution if utensils are delicate!)

1. Close the door.
2. Switch on ON/OFF switch .
3. Press and hold down the START button .
4. Rotate programme selector  until  is indicated on the digital display .
5. Release button. The factory-set value  is lit on the digital display  (intensive drying off).

Change the setting as follows:

1. By rotating the programme selector , you can switch intensive drying on  or off .

2. Press START button . The set value is saved.



Cleaning and maintenance

A regular inspection and maintenance of your machine will help to prevent faults. This saves time and prevents problems.

Overall condition of the machine

- Check spray arm for grease and limescale deposits. If you find such deposits:
- Fill detergent dispenser with detergent. Start the appliance without utensils in the programme with the highest rinsing temperature.

Clean the appliance with detergents/ appliance cleaners which are particularly suitable for use with dishwashers.

- To extend the life of your appliance, clean the appliance regularly with a special dishwasher detergent.
- To ensure that the door seal always remains clean and hygienic, regularly clean it with a damp cloth and a little washing-up liquid.
- If the appliance is switched off for a prolonged period, leave the door ajar to prevent the formation of an unpleasant odour.

Never use a steam cleaner to clean your dishwasher. The manufacturer is not liable for any consequential damage. Regularly wipe the front of the appliance and fascia with a damp cloth; water and a little washing up liquid are adequate. Do not use sponges with a rough surface or abrasive detergents, as these could scratch the surfaces.

Stainless steel appliances: To prevent corrosion, avoid using sponge cloths or wash them out thoroughly several times before using for the first time.



Warning – Health hazard Never use other domestic detergents, e.g. containing chlorine!

Rinse aid

- Check the refill indicator . If required, refill rinse aid.

Filters

The filters keep large foreign objects in the rinsing water away from the pump. These foreign objects may occasionally block the filters. The filter system consists of a coarse filter, a flat fine filter and a microfilter.

1. After each washing cycle check the filters for residue.

2. Unscrew filter cylinder as illustrated and take out filter system.

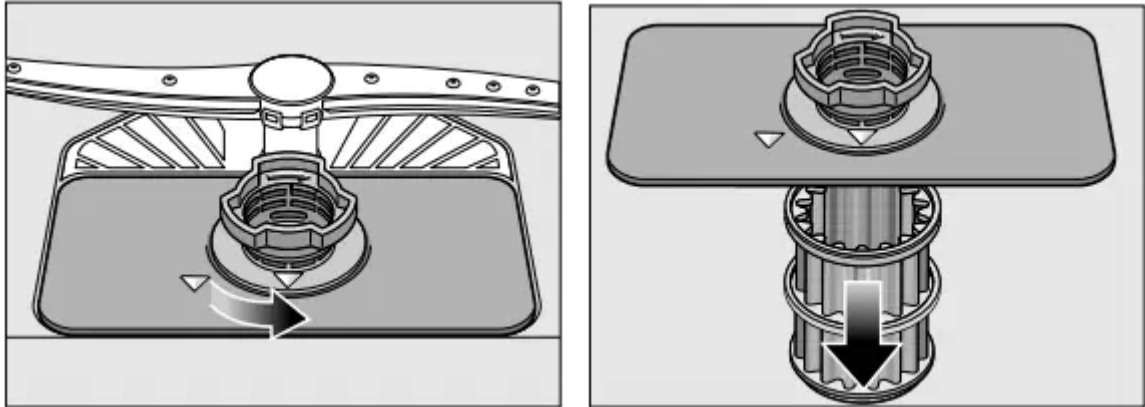

3. Remove any residue and clean filters under running water.

4. Re-install filter system in reverse sequence and ensure that the arrow marks are opposite each other after closing the filter system.

Spray arms

Limescale and contaminants in the rinsing water may block nozzles and bearings on the spray arms **23** and **24**.

1. Check outlet nozzles on the spray arms for blockages.

2. Unscrew the upper spray arm **23**

3. Remove the lower spray arm **24** upwards.

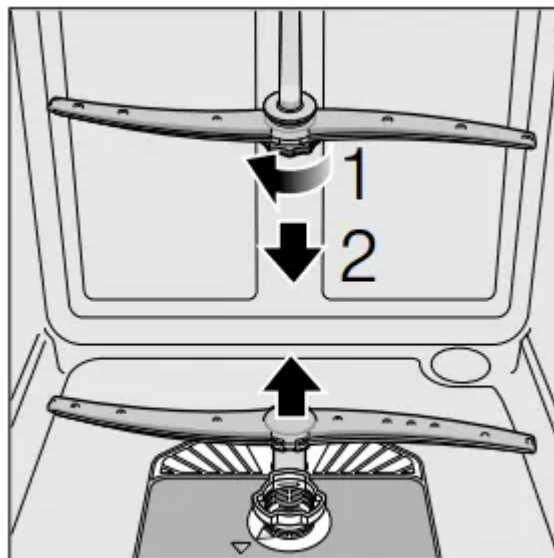

4. Clean spray arms under running water.

5. Re-engage or screw on spray arms.



Fault, what to do?

Experience has shown that you can rectify most faults which occur in daily operation yourself. This ensures that the machine is quickly available to you again. In the following overview you can find possible causes of malfunctions and helpful information for rectifying them.

Note If the appliance stops during dishwashing or does not start for no obvious reason, first run the Abort programme function (Reset). (See chapter entitled “Operating the appliance”)

⚠ Warning – Don’t forget: Repairs may be carried out by technicians only. If a component has to be replaced, ensure that only original spare parts are used. Improper repairs or use of non-original spare parts may cause considerable damage and put the user at considerable risk.

Waste water pump

Large food remnants or foreign objects which were not captured by the filters may block the waste water pump. The rinsing water will then be above the filter.

⚠ Warning – Risk of cuts!

When cleaning the waste water pump, ensure that you do not injure yourself on pieces of broken glass or pointed implements.

In this case:

1. First always disconnect the appliance from the power supply.
2. Take out top basket **20** and bottom basket **27**.
3. Remove the filters **25**.
4. Scoop out water, use a sponge if required.
5. Prise out the white pump cover (as illustrated) using a spoon. Grip the cover on the crosspiece and lift diagonally inwards. Remove cover completely.

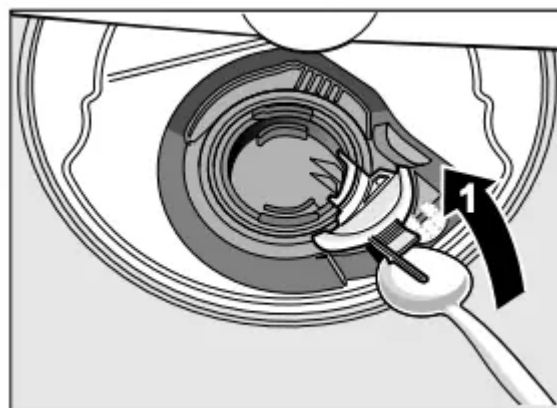

6. Check impeller wheel and remove any foreign objects.

7. Place cover in the original position and press down until it engages (click).

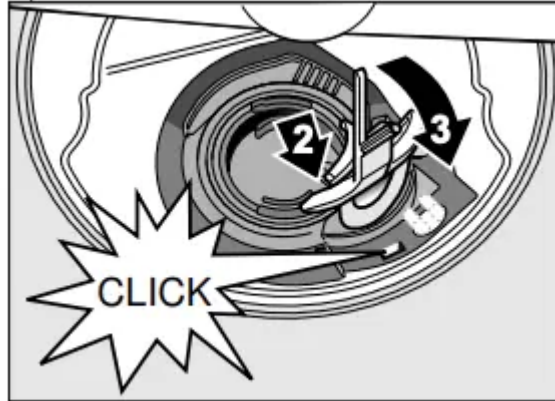

8. Install filters.

9. Re-insert baskets.

Fault table

“Check water supply” display ' 9 ' lights up.

Supply hose kinked.

- Install supply hose without kinks.

Tap turned off.

- Turn on the tap.

Tap jammed or calcified.

- Turn on the tap. Flow rate must be min. 10 l/min. when water supply is open.

Filter in the water supply blocked.

- Switch off the appliance and pull out the mains plug. Turn off the tap. Unscrew water connection.

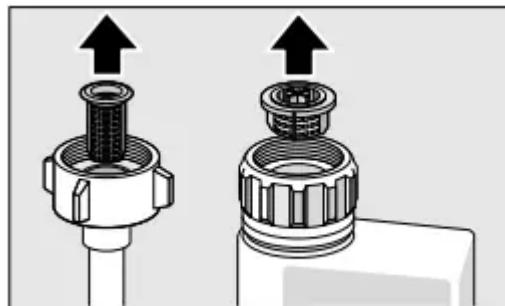

Error code *E:07* is lit.

Intake opening (on right inside of appliance) covered by utensils.

- Arrange utensils so that the intake opening is not obstructed.

Error code E:12 **is lit.**

Heating element soiled.

- Clean appliance with dishwasher cleaning agent.

Fault code E:14 **is lit.**

Water protection system activated.

- Turn off tap.

Fault code E:15 **is lit**

Water protection system activated.

- Call customer service and mention the fault code.

Fault code E:16 **is lit.**

Constant water inflow

- Call customer service and mention the fault code.

Error code E:22 **is lit.**

Filters 25 are soiled or blocked.

- Clean filters. (See Cleaning and maintenance)

Error code E:24 **is it.**

Waste water hose is blocked or kinked.

- Install hose without kinks, remove any residue.

Siphon connection still sealed.

- Check connection to siphon and open if required.

Cover on the waste water pump loose.

- Lock cover correctly. (See Waste water pump)

Error code E:25 **is lit.**

Waste water pump blocked or cover on the waste water pump is not locked in position.

- Clean pump and lock cover correctly. (See Waste water pump)

Error code E:27 **is lit.**

Mains voltage too low.

- Not an appliance fault, have the mains voltage and electrical installation checked.

A different error code is indicated on the digital display. (E:01 to E:30)

A technical fault has probably occurred.

- Switch off appliances with the ON/OFF switch . After a short time restart the appliance. If the problem recurs, turn off the tap and pull out the mains plug. Call customer service and mention the error code.

Display flashes

Door not closed properly.

- Close the door. Ensure that no objects (utensil, fragrance dispenser) are protruding over the basket and preventing the door from closing.

Refill indicator for rinse-aid 8 is lit.

No rinse aid.

- Refill rinse aid.

Refill indicator for rinse-aid 8 is not lit.

Refill indicator switched off.

- Activation/deactivation (see chapter Rinse aid).

There is still enough rinse aid available.

- Check refill indicator, level.

Water is left in the appliance at the end of the programme.

Filter system or area under the filters 25 is blocked.

- Clean filters and area underneath (see Waste water pump).

The programme has not yet ended.

- Wait until programme ends or reset (see Terminating the programme).

Utensils not dry.

No or too little rinse aid in the dispenser.

- Refill rinse aid.

Programme selected without drying.

- Select programme with drying (see Overview of programmes, Programme sequence).

Water collecting in depressions on the utensils and cutlery.

- Arrange utensils in a sloping position, arrange affected utensils as sloping as possible.

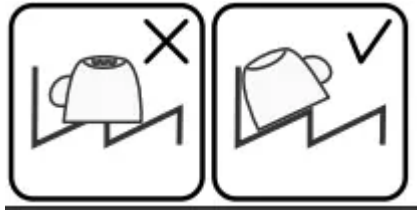

The combined detergent used has a poor drying performance.

- Use different combination detergent with better drying performance. Use of rinse aid also increases the drying performance

Intensive drying to increase drying not activated.

- Activate intensive drying (see Operating the appliance)

Utensils were removed too early or drying process had not ended yet.

- Wait until program ends or wait until 30 min after program ends before removing utensils.

The eco rinse aid used has a poor drying performance.

- Use a proprietary rinse aid. Eco products are much less effective.

Plastic utensils not dry.

Special properties of plastic.

- Plastic has a lower heat storage capacity and therefore dries less well.

Cutlery not dry.

Cutlery not arranged properly in the cutlery basket.

- Separate cutlery if possible, prevent contact points.

Cutlery not arranged properly in the cutlery drawer.

- Arrange cutlery properly and separate if possible.

Appliance interior wet after rinse cycle.

No appliance fault.

- On account of the “Condensation drying” principle, water droplets are physically induced and required in the container. The humidity in the air condenses on the inner walls of the dishwasher, drains and is pumped out.

Food remnants on the utensils.

Utensils placed too closely together, utensils basket overfilled.

- Arrange utensils with adequate clearance between them ensuring that the spray jets can reach the surface of the utensils. Prevent contact points.

Spray arm rotation obstructed.

- Arrange utensils so that the spray arm can rotate without obstruction.

Spray arm nozzles blocked.

- Clean the spray arm nozzles, (See Cleaning and maintenance).

Filters **25** dirty.

- Clean filters, (see Cleaning and maintenance).

Filters **25** inserted incorrectly and/or not engaged.

- Insert and engage filters correctly.

Rinse programme too weak.

- Select a more intensive rinse programme.

Utensils precleaned too intensely; sensors therefore decide on weak programme sequence.
Stubborn soiling cannot be completely removed.

- Do not prerinse utensils. Remove only large food remnants.

Tall narrow receptacles in corner areas are not rinsed adequately.

- Do not place hollow receptacles too obliquely and do not place in the corner area.

Top basket **20** on right and left not set to same height.

- Set top basket to same height using side levers.

Detergent residue

Detergent dispenser cover blocked by utensils and therefore does not open fully.

- Detergent dispenser cover must not be obstructed by utensils.
- Do not place utensils or fragrance dispenser in the tablet collecting tray.

Detergent dispenser cover blocked by the tablet.

- Tablet must be inserted flat and not upright.

Tablets used in the quick or short programme.

- Dissolving time of the detergent is not reached in the selected short programme.

Dissolving time of tablets too long for a quick or short programme.

- Use a detergent powder or select a more intensive programme.

Washing effect and dissolving performance are reduced after a prolonged storage time or detergent is very lumpy.

- Change detergent.

Water stains on plastic parts

Droplet formation on plastic surface is physically unavoidable. After drying, water stains are visible.

- Use a more intensive programme (more water changes).
- Arrange utensils in a sloping position.
- Use rinse aid.

Washable or water-soluble coatings in the container or on the door.

Detergent substances are deposited. These coatings cannot usually be removed with chemicals (appliance cleaner, ...).

- Change detergent brand.
- Clean appliance mechanically.

Only for glasses: Initial glass corrosion – can only apparently be wiped off.

- See Glass and utensil damage.

White, stubborn coatings: limescale on the utensils, container or door.

Detergent substances are deposited. These coatings cannot usually be removed with chemicals (appliance cleaner, ...).

- Change detergent brand.
- Clean appliance mechanically.

Underdosing of detergent.

- Increase detergent dosage or change detergent.

Too weak rinse programme selected.

- Select a more intensive rinse programme.

Tea or lipstick residue on the utensils.

Too low rinsing temperature.

- Select programme with higher washing temperature.

Too little or unsuitable detergent.

- Use suitable detergent at correct dosage.

Utensils precleaned too intensely; sensors therefore decide on weak programme sequence. Stubborn soiling cannot be completely removed.

- Do not prerinse utensils. Remove only large food remnants.

Coloured (blue, yellow, brown), difficult to remove to non-removable coatings in the appliance or on stainless steel utensils

Film formation consisting of ingredients from vegetables (e.g. cabbage, celery, potatoes, noodles, ...) or the tap water (e.g. manganese).

- Can be partly removed with machine cleaner or by mechanical cleaning. Coatings are harmless

Film formation caused by metallic components on silver or aluminium utensils.

- Can be partly removed with machine cleaner or by mechanical cleaning.

Discolouration of the plastic parts inside the appliance.

Plastic parts inside the appliance may become discoloured during the service life of the dishwasher.

- Discolouration is normal and will not impair the function of the dishwasher.

Plastic parts discoloured.

Too low rinsing temperature.

- Select programme with higher washing temperature.

Utensils precleaned too intensely; sensors therefore decide on weak programme sequence. Stubborn soiling cannot be completely removed.

- Do not prerinse utensils. Remove only large food remnants.

Removable streaks on glasses, glasses with metallic appearance and cutlery.

Too much rinse aid.

- Set rinse aid amount to lower setting.

No rinse aid added or setting too low.

- Add rinse aid and check dosage recommended setting 4-5).

Detergent residue in the final rinse programme section.

- Detergent dispenser cover must not be obstructed by utensils.

Detergent dispenser cover blocked by utensils (cover does not open fully).

- Do not place utensils or fragrance dispenser in the tablet collecting tray.

Utensils precleaned too intensely; sensors therefore decide on weak programme sequence. Stubborn soiling cannot be completely removed.

- Do not prerinse utensils. Remove only large food remnants.

Initial or existing, irreversible clouding of glass.

Glasses not dishwasher-proof, only suitable for dishwasher.

- Use dishwasher-proof glasses.
- Avoid long steam phase (standing time after wash cycle ends).

- Use wash cycle at lower temperature.
- Use detergent with glass protection component.

Rust spots on the cutlery.

Cutlery not adequately rustresistant. Knife blades are frequently more severely affected.

- Use corrosion-resistant cutlery.

Cutlery will also rust if rusting parts are rinsed at the same time (pan handles, damaged utensil baskets, etc.).

- Do not wash rusting parts.

The appliance does not start.

The mains fuse has tripped.

- Check mains fuse.

Power cord not inserted.

- Ensure that the power cord is plugged all the way into the back of the appliance and into the socket. Check that the socket functions.

The appliance door has not been shut properly.

- Close the door.

Programme starts automatically.

You did not wait until programme ended.

- Perform reset. (See Terminating the programme).

The door is difficult to open.

Child-proof lock is activated.

- Deactivate childproof lock. (See instructions for use at the back)

Door cannot be closed.

Door lock has been activated.

- Close door with increased force.

Door cannot be closed due to installation.

- Check appliance installation: Door or attached parts must close without obstruction.

Cover on the detergent dispenser cannot be closed.

Detergent dispenser or cover guide blocked by sticky detergent residue.

- Remove detergent residue.

Detergent residue in the detergent dispenser or in the tablet collecting tray.

Spray arms blocked by utensils, therefore detergent is not rinsed out.

- Ensure that the spray arms can rotate freely.

The detergent dispenser was damp when filled.

- Pour detergent into the dry detergent dispenser only.

Appliance stops in the programme or programme is interrupted.

Door not closed properly.

- Close the door

Do not place utensils or fragrance dispenser in the tablet collecting tray.

- Check whether rear panel is being pressed in, e.g. by socket or by hose holder which has not been removed.

Top basket presses against inner door and prevents door from being closed securely

- Check whether rear panel is being pressed in, e.g. by socket or by hose holder which has not been removed.

Power and/or water supply interrupted.

- Restore power and/or water supply.

Filling valves making striking noises.

Depends on domestic installation, as appliance is not defective.

- No effect on appliance function. No remedial action possible.

Knocking or rattling noise.

Spray arm strikes the utensils, utensils not positioned correctly.

- Position utensils so that the spray arms do not strike the utensils.

If there is a low load, the water jets strike the washing tank directly.

- Load the appliance with more utensils or distribute the utensils more evenly in the dishwasher.

Light utensils move during the wash cycle.

- Arrange light utensils securely.

Unusual foam formation.

Handwash liquid in the rinse aid dispenser.

- Immediately refill rinse aid dispenser with rinse aid.

Rinse aid spilled.

- Remove rinse aid with a cloth.

Warning

This content is compiled from multiple sources and is provided for reference purposes only. It may not be complete or fully applicable to all situations. If you are unable to resolve your issue, please contact the product manufacturer or an authorized service provider for official support.

Document generated by [ManualsFile](#)