

Before Starting to Wash

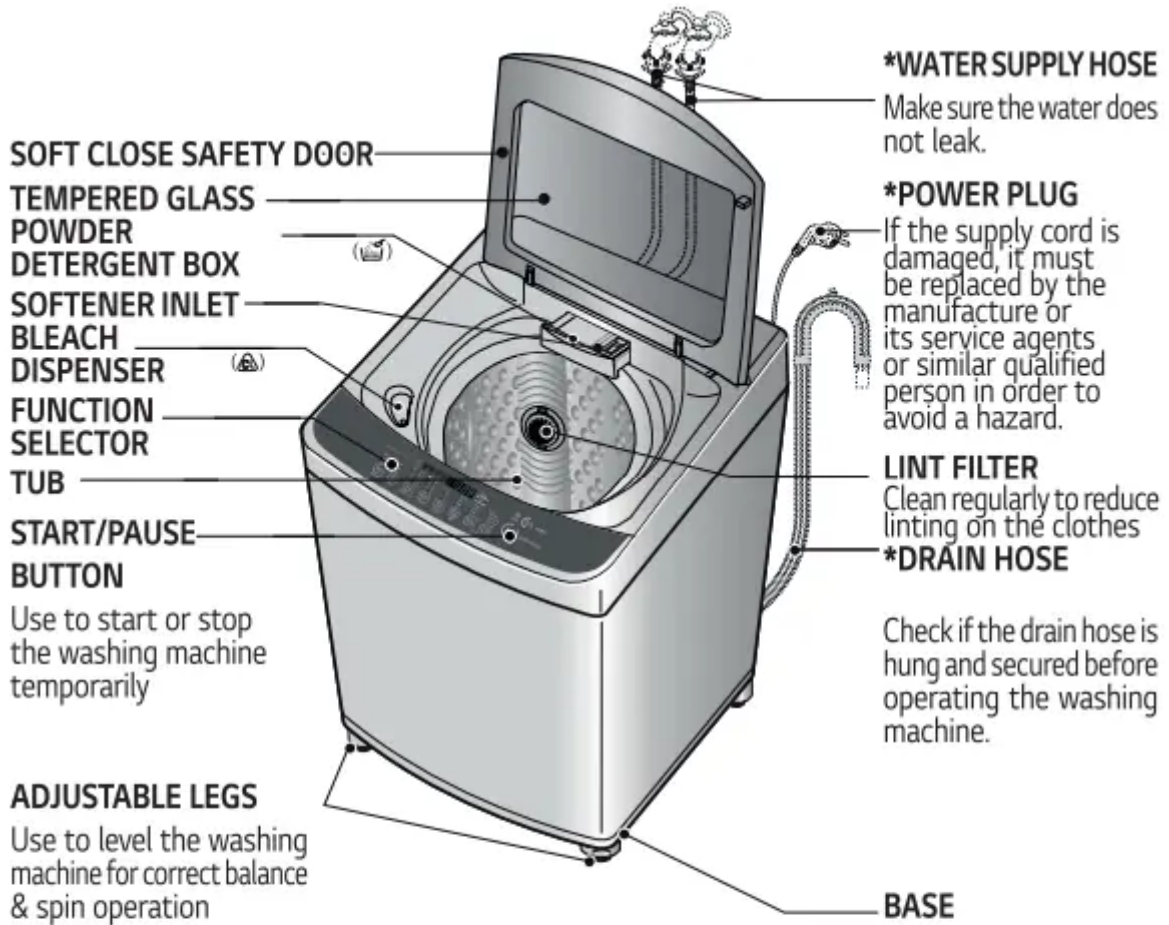

Accessories

Water supply hoses

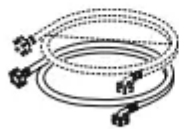

1 Each for Cold and Hot water

Drain hose

For Non-Pump model



For Pump model



NOTE: "*" Parts can be different according to the model.

Introduction

Function Information

Our machine provides various washing methods which suits various conditions and types of laundry.

Different types of laundry washing

Cotton Wash

Use this Program for everyday washing e.g. sheets, towels, T-shirts. (refer to page 16)

Duvet Wash

Use for blanket or Duvet with (Hand Wash) sign. (refer to page 16)

Eco Cotton

Use this Program to save water consumption. (refer to page 16)

Wool Wash

Wool clothes (lingerie, wool, etc.) Which may be easily damaged can be washed. (refer to page 16) The fibers of machine washable woolens have been specifically modified to prevent felting when they are machine washed.

Most hand knitted garments are not made of machine washable wool and we recommend that you hand wash them

- Before washing your woolens check the care label for the washing instructions.
- When washing woolens use a mild Detergent recommended for washing wool.
- Hand washed woolens may be spun in a washing machine to reduce the time they take to dry.
- To dry woolens lay down them flat on a towel and pat into shape. Dry woolens out of direct sunlight. (The heat and tumble action of a dryer may cause shrinkage or felting of woolen garments.) Some wool underlays and sheepskin products can be washed in a washing machine but may cause pump blockages.

(Ensure that the whole article is suitable for machine washing and not just the backing material.) You may wish to hand wash these articles and place them in the machine to spin dry.

Cotton Pre Wash

Washing laundry with Cotton cycle that pretreats immediate stain without hand-wash. i.e. Necessary for clothes which could be smelled badly without prompt laundry. (refer to page 18)

Silent Wash

Use this program to wash quietly at night. (refer to page 18)

Washing according to the condition of laundry

Quick Wash

Quick Wash can be selected to wash lightly soiled clothes of less than 2.0 kg in a short time.(refer to page 16)

Soak Wash

Soak Wash can be selected to wash heavily soiled laundry by soaking in water for some time to help remove dirt and grime. (refer to page 20)

Other options and functions

Tub Clean

Use this program to clean the inside of washing machine especially Inner tub & Outer tub (refer to page 21)

Delay Start Wash

Delay Start Wash is used to delay the finishing time of the operation. The number of hours to be delayed can be set by the user accordingly. (refer to page 24)

Option Wash

When the user needs only Spin, Rinse/Spin, Rinse, Wash/Rinse, Wash, Wash/Rinse/Spin, Soak/Wash/ Rinse/Spin. (refer to page 23)

Before Starting to Wash

Preparation Before Washing

Care Labels

*Look for a care label on your clothes. This will tell you about the fabric content of your garment and how it should be washed

Sort clothes into loads that can be washed with the same wash cycle, Water Temperature and spin speed.



Sorting

To get the best results, different fabrics need to be washed in different ways.

- **SOIL** (Heavy, Normal, Light) Separate clothes according to the type and amount of soil.
- **COLOR** (Whites, Lights, Darks) Separate white fabrics from colored fabrics.
- **LINT** (Lint producers, Collectors) Separate lint producers and lint collectors.

Lint Producers Terry cloth, Chenille, Towels, Nappies, Diapers

Lint Collectors Synthetics, Corduroy, Permanent Press, Socks.



Check before Loading



- Check all pockets to make sure that they are empty. Things such as nails, hair clips, matches, pens, coins, and keys can damage both your washer and your clothes
- Mend any torn garments or loose buttons. Tears or holes may become larger during washing. Remove belts, under wires, etc. to prevent damage to the machine or your clothes.
- Pretreat any dirt and stains.
- Make sure the clothes are washable in water.
- Check the washing instructions.
- Remove tissue in pockets.

Caution

Do not wash or spin any item labeled or known to be water-proof or water-resistant, even if the product care label on the item permits machine washing. Failure to follow these instructions could result in severe damage to your laundry, your washer and/or property damage as a result of abnormal vibration of the washer.

- Examples of water-proof or water-resistant items include certain mattress pads, mattress covers, rain gear, camping gear, skiing apparel, outdoor gear and similar items.

Pretreatment on stains or heavy soil

- Use 'PreWash+Cotton' cycle for very soiled clothes. In case of heavily soiled clothes, pretreatment may require before the cycle.
- Pretreat shirt collars and cuffs with a pre-wash product or liquid Detergent when placing them in the washer. Before washing treat special 'stains with bar soaps, liquid Detergent or a paste of water and granular Detergent.
- Use a pretreat soil and stain remover. Treat stains AS SOON AS POSSIBLE. The longer they are left the harder they are to remove. **(For more detail refer to page 13)**

Loading

Do not wash fabrics containing flammable materials (waxes, cleaning fluids, etc.).

Load Size

The Water Level should just cover the clothes. Adjust the load size accordingly. Loosely load clothes no higher than the top row of holes in the washer tub. To add items after washer has started, press Start button and submerge additional items. Close the lid and press Start button again to restart.

Light and Large-sized clothing

Clothes like downs and woollens are light weight, large and float easily. Use a nylon net and wash them in a higher level of water. If the laundry floats during the wash cycle, it may become damaged. Use dissolved Detergent to prevent the Detergent from clumping

Long laundry items

Use nylon nets for long, DELICATE items. For laundry with long strings or long length, a net will prevent tangling during washing. **Fasten zippers, hook, and strings** to make sure that these items don't snag on other clothes.

* Nylon net is not supplied by LG.

WARNING

Fire Hazard Never place items in the washer that are dampened with gasoline or other flammable fluids. No washer can completely remove oil.

Do not dry anything that has ever had any type of oil on it (including cooking oils). Doing so can result in death, explosion, or fire.



Use of Water, Dispenser Drawer, Detergent and Softener

Using Water

Amount of Water Level



- This machine detects quantity of laundry automatically, then sets the Water Level according to the weight of the clothes. The display also shows the suggested amount of detergent to be added.
- When you select a wash Program, the Water level and amount of detergent (to be used) will be shown on the panel.
- The following table shows the amount of water.
- When the water level is automatically detected, the detergent level may differ depending on the quantity of laundry even though the same water level is indicated on the control panel.

NOTE

[Minimum water amount]

Water Level Water level depends on laundry load weight and the washer model. The washer detects the required minimum water level and will not start washing until this water level is reached. The water will fill automatically via the inlet valves, however if water is manually poured into the tub via a bucket or similar vessel (NOT RECOMMENDED), the washer will still detect this water and the wash cycle will commence once the required water level is reached. NOTE: the cycle will not start until the lid is closed. Increasing the water level manually may be necessary with bulky light weight loads..

Water Temperature (WARM,COLD: Option for Only 2 Vale)

- The machine sets the appropriate temperature automatically according to the wash Program,
- You can change the water temperature by pressing the Water Temp. Button. (refer to page 14)
- The temperature of the water impacts the effectiveness of all laundry additives and therefore, the cleaning results. We recommend temperatures of:
 - HOT 49-60 °C White items, diapers, underclothing and heavily soiled, colorfast items.
 - WARM 29-40 °C Most items.
 - COLD *18-24 °C Only very bright colors with light soil.
- When washing in Cold water additional steps may be needed:

- Adjust Detergent amount and pre-dissolve 'Detergent in Warm water
- Pretreat spots and stains
- Soak heavily soiled items
- Use appropriate bleach

* Temperature below 18 °C will not activate laundry additives and may cause lint, residue, poor cleaning, etc. In addition, Detergent manufactures and care labels define Cold water as 26-29

. If the temperature of the water in the tub is too cold for your hands, the Detergent will not activate and clean effectively.

Attention

If iron is present in the water the clothes may become an all-over yellow or they may be stained with brown or orange spots or streaks. Iron is not always visible. Installation of water softener or an iron filter may be necessary for severe cases.

Using Water

Using the Dispenser Drawer

The dispenser drawer contains 2 compartment:

- Liquid Fabric Softener
- Liquid or Powder Low-Sudging, High-Efficiency Detergent

The Dispenser automatically dispenses additives at the proper time in the wash cycle.

1. Slowly open the dispenser drawer by pulling the drawer out until it stops.
 2. After adding laundry products, slowly close the dispenser drawer. Closing the drawer too quickly could result in early dispensing of additives.
- Avoid overfilling or splashing when adding laundry products to the dispenser. Doing so could result in early dispensing of laundry products.

At the of the cycle, you may see water in the compartments. This is part of the normal operation of the washer.

NOTE: Do not use bleach in the dispenser drawe



Using detergent

Detergent

Follow the detergent package directions. Using too little detergent is a common cause of laundry problems. Use more detergent if you have hard water, large loads, greasy or. When warm water is used for washing, the normal soap dosage can be used to give the best results.

Choosing the right Detergent

We recommend the use of domestic detergent, (powder, liquid or concentrated). Soap flakes or granulated soap powders should not be used in your washing machine. When washing woolens remember to use detergent suitable for washing woolens.

How much Detergent

When you select a wash Program the water level and the amount of detergent (to be used) will be shown on the control panel. The amount of a cup in the diagram is about 40 g for concentrated detergent.

The correct amount of Detergent will vary depending on the amount of soil in your clothes (Jeans and work clothes may need more Detergent, while bath towels usually need less.).

For liquid and concentrated Detergents, follow the recommendations of the Detergent manufacturer.

Note: To check you are using the correct amount of Detergent, lift the lid of your machine about half-way through the wash. There should be a thin layer of foam over the surface of the water. Lots of foam may look good, but it does not contribute to cleaning your clothes. No foam means not enough detergent has been used or the water temperature is too cold for the soap to dissolve; soil and lint can settle back on the clothes or the washing machine. If excess detergent and cold water is used, the rinse will not be as clean and efficient. Also, it could cause environmental pollution, And long term scrud build up within the machine.

Adding the Detergent

Add measured detergent to the detergent compartment of the dispenser drawer.

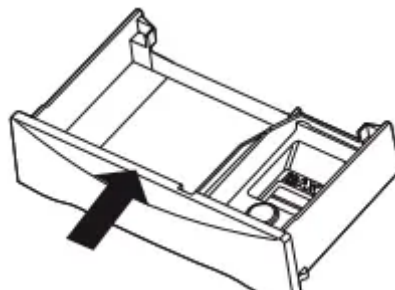

Detergent is flushed through the dispenser at the beginning of the wash phase.

Detergent usage may need to be adjusted for water temperature, water hardness, size and soil level of the load.

Avoid using too much detergent in your washer, as it can lead to oversudsing and detergent residue being left on the clothes.

Note: Using Liquid detergent

- Dilute Liquid detergent with water and pour into the tub, start the cycle.
- Delay wash Program is not available if you use liquid detergent.



Attention

Using liquid detergent without diluting, or leaving laundry for a long time after pouring dilute liquid detergent into the tub might cause damage, bleaching or discoloration of cloth.

Using Liquid Bleach

- Check clothing care label for special instructions and separate the laundry to be bleached
- Dilute liquid chlorine bleach.
- Measure the recommended amount of liquid bleach carefully following instructions on the bottle.
- Before starting the washer, pour measured amount of bleach directly into bleach dispenser. Avoid splashing or overfilling. Powdered bleach should be mixed with water before pouring.

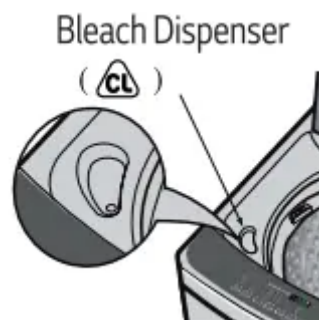

NOTE:

- Never pour undiluted liquid bleach directly onto clothes or into the wash basket. This may cause change of color or damage the laundry.
- Do not pour powdered bleach into bleach dispenser.

Use Fabric Softener

If desired, Pour the recommended amount of liquid fabric softener into the right-hand compartment.

Use only liquid fabric softener.

Dilute with water to the maximum fill line

- Do not exceed the maximum fill line.

Overfilling can cause early dispensing of the fabric softener, which could stain clothes

NOTE: Do not pour fabric softener directly on the wash load, It may stain the clothes.

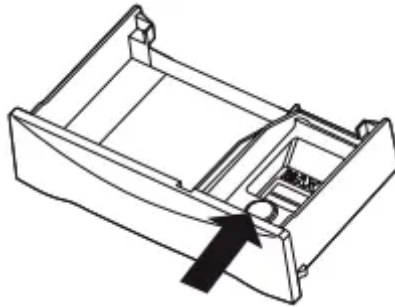

Attention

- Do not mix with Detergent with bleach.
- Never pour fabric softener directly on clothes. It may stain them.
- Do not stop the washer during the first spin as it will interrupt the softener's timely dispensing.
- Option washing (eg: extra rinse) is not designed to be used with the fabric softener dispenser.

Scrud (Waxy Build up)

Scrud is the name given to the waxy build-up that can occur within any washer when the fabric softener comes into contact with Detergent. This build-up is not brought about by a fault in the machine. **If scrud is allowed to build-up in the machine it can result in stains on your clothes or an unpleasant smell in your washer.**

If you wish to use fabric softener we recommend

- Using fabric softener sparingly.
- When filling the dispenser, do not splash or overfill.
- Clean dispenser as soon as the cycle is finished. Clean your machine regularly. (refer to page 21 or 32)
- Cold water washing increases the chance of this build-up occurring. We recommend a regular Warm or Hot wash e.g. every 5th wash should be at least a warm one.
- Fabric softener of thinner consistency is less likely to leave residue on the dispenser and contribute to a build-up.

- Selecting the extra rinse option when using the Eco Cotton cycle. (in which case the softener will need to be added manually when the beeping sounds repeatedly after the wash cycle)

Special Guide for Stain Removal

WARNING

- Do not use or mix liquid chlorine bleach with other household chemicals such as toilet cleaners, rust removers, acid or products containing ammonia. These mixtures can produce dangerous fumes which can cause serious injury or death.
- To reduce the risk of fire or serious injury to persons or property, comply with the basic warnings listed below:
- Read and comply with all instructions on stain removal products.
- Keep stain removal products in their original labeled containers and out of children's reach
- Thoroughly wash any utensil used.
- Do not combine stain removal products, especially ammonia and chlorine bleach. Dangerous fumes may result.
- Never wash items which have been previously cleaned in, washed in, soaked in or spotted with gasoline, dry cleaning solvents or other flammable or explosive substances because they give off vapors that could ignite or explode.
- Never use highly flammable solvents, such as gasoline, inside the home. Vapors can explode on contact with flames or sparks.

For successful stain removal:

- Remove stains promptly.
- Use 'Pre Wash+Cotton cycle for very soiled clothes. In case of heavily soiled clothes, pretreatment may require before the cycle.
- Determine the kind of stain, then follow the recommended treatment in the stain removal chart below.
- To pretreat stains, use a prewash product, liquid Detergent, or a paste made Follow fabric care from granular Detergent and water.
- Use COLD water on unknown stains because HOT water can set stains.
- Check care label instructions for treatments to avoid on specific fabrics.
- Check for colorfastness by testing stain remover on an inside seam.
- Rinse and wash items after stain removal.



STAIN Removal

Adhesive tape, chewing gum, rubber cement

- Apply ice. Scrape off excess. Place stain face down on paper towels. Saturate with prewash stain remover or nonflammable dry cleaning fluid.

Baby formula, dairy products, egg

- Use product containing enzymes to pretreat or soak stains.

Beverages (coffee, tea, soda, juice, alcoholic beverages)

- Pretreat stain. Wash using COLD water and bleach safe for fabric.

Blood

- Rinse with COLD water. Rub with bar soap. Or pretreat or soak with product containing enzymes. Wash using bleach safe for fabric.

Candle wax, crayon

- Scrape off surface wax. Place stain face down between paper towels. Press with warm iron until wax is absorbed. Replace paper towels frequently. Treat remaining stain with prewash stain remover or nonflammable dry cleaning fluid. Hand wash to remove solvent. Wash using bleach safe for fabric.

Chocolate

- Pretreat or soak in WARM water using product containing enzymes. Wash using bleach safe for fabric.

Collar or cuff soil, cosmetics

- Pretreat with prewash stain remover or rub with bar soap.

Dye transfer on white fabric

- Use packaged color remover. Wash using bleach safe for fabric.

Grass

- Pretreat or soak in WARM water using product containing enzymes. Wash using bleach safe for fabric.

Grease, oil, tar (butter, fats, salad dressing, cooking oils, car grease, motor oils)

- Scrape residue from fabric. Pretreat. Wash using hottest water safe for fabric. For heavy stains and tar, apply nonflammable dry cleaning fluid to back of stain. Replace towels under stain frequently. Rinse thoroughly. Wash using hottest water safe for fabric.

Ink

- Some inks may be impossible to remove. Washing may set some inks. Use prewash stain remover, denatured alcohol or nonflammable dry cleaning fluid.

Mildew, scorch

- Wash with chlorine bleach if safe for fabric. Or, soak in oxygen bleach and HOT water before washing. Badly mildewed fabrics may be permanently damaged.

Mud

- Brush off dry mud. Pretreat or soak with product containing enzymes.

Mustard, tomato

- Pretreat with prewash stain remover. Wash using bleach safe for fabric.

Nail polish

- May be impossible to remove. Place stain face down on paper towels. Apply nail polish remover to back of stain. Repeat, replacing paper towels frequently. Do not use on acetate fabrics.

Paint, varnish

- WATER BASED: Rinse fabric in cool water while stain is wet. Wash. Once paint is dry, it cannot be removed, OIL BASED AND VARNISH: Use solvent recommended on can label. Rinse thoroughly before washing For spots, use rust remover safe for fabric.

Rust, brown or yellow discoloration

- For discoloration of an entire load, use phosphate Detergent and **Do not use chlorine bleach because it may intensify discoloration.**

Shoe polish

- LIQUID: Pretreat with a paste of granular Detergent and water. PASTE: Scrape residue from fabric. Pretreat with prewash stain remover or nonflammable dry cleaning fluid. Rub Detergent into dampened area, Wash using bleach safe for fabric.

Function of each Button

Water Temperature Button

- Use to select Water Temperature. Pressing the button allows you to select COLD ▶ WARM(HOT&COLD) ▶ HOT ▶ COLD respectively. Default setting is COLD.

Water Level Button

- Use to select the proper amount of water in relation to the weight, volume and type of laundry.
- Automatically controlled, but can be selected manually by pressing the **Water Level** Button.
- Water is automatically selected for Cotton Program. The following settings are indicated as the button is pushed 7 ▶ 8 ▶ 9 ▶ 10 ▶ 1 ▶ 2 ▶ 3 ▶ 4 ▶ 5 ▶ 6 ▶ 7

Soil Level Button

- This button allows you to select the strength of the wash action
- Power option selections light up in sequence as follows Normal ▶ Heavy ▶ Light ▶ Normal as the button is pushed. This can be selected for most Programs.
- Adjustment can be made while washing

Air Spin

- This function is used to help reduce moisture from the clothes until they are removed for drying. This function alone will not dry the clothes.
- Air Spin selections light up in sequence as follows 30 ▶ 60 ▶ 90 ▶ 120
- If you want to use Air Spin, Press & hold 3 seconds. Spin key.

Child Lock Function

- Use to lock or unlock the control buttons to prevent settings from being changed by a child. To lock, push and hold the Rinse button and to unlock push and hold one more time during the washing process.
(refer to page 25)







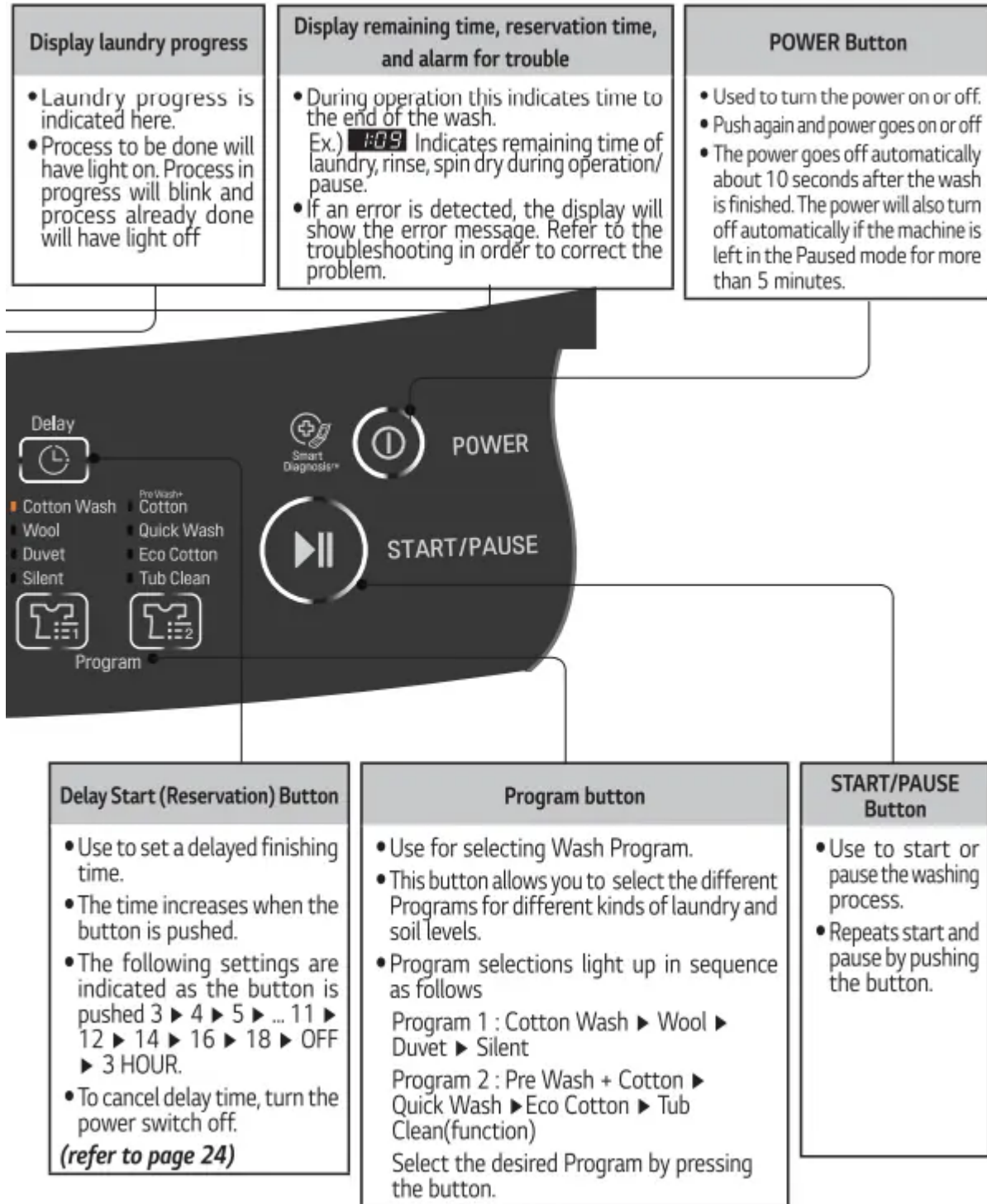













Wash. Rinse. Spin Button

















- Use when wash, rinse, spin time need to be adjusted.
- The time increases when the button is pressed.
- If adjustments are needed during the wash, press the [start/pause] button before making any changes.
- When the button is pressed during washing, the remaining time is displayed.









NOTE: *The control panel may differ according to different models.

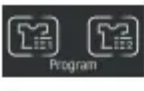





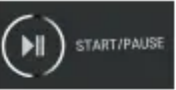

Washing Program

Washing Program	 POWER	Add the laundry	 Program	Add the detergent
<p style="text-align: center;">Cotton Wash</p> <p>Used for normal loads, this mode automatically selects the most appropriate conditions according to the weight and completes the sequence in one operation. The load sensing detects the size of the load and the ideal wash power and wash, rinse and spin times are set accordingly.</p>				 <ul style="list-style-type: none"> • Add the appropriate quantity of Detergent as indicated by the WATER LEVEL next to Water Detergent. Or follow the Detergent manufacturer's instructions
<p style="text-align: center;">Wool</p> <p>Use this program for washing delicate fabrics such as lingerie and woollens. (wash only "machine washable" clothes) Before washing your woollens read the care label for the washing instructions.</p>			 <ul style="list-style-type: none"> • Select the Wool program on the Control panel. 	 <ul style="list-style-type: none"> • Use neutral Detergent appropriate for the laundry. • When washing woollens use a mild Detergent recommended for washing wool.
<p style="text-align: center;">Quick Wash</p> <p>Use this mode when washing lightly soiled clothes for a short time. The weight limit for this cycle is 2kg.</p>			 <ul style="list-style-type: none"> • Select the Quick Wash Program on the Control panel. 	 <ul style="list-style-type: none"> • Add the appropriate quantity of Detergents as indicated by the Water Level next to Water Detergent. Or follow the Detergent manufacturer's instructions
<p style="text-align: center;">Duvet</p> <p>Use Duvet Program when washing Jeans of different sizes</p>		 <ul style="list-style-type: none"> • Place the jeans evenly in the tub. 	 <ul style="list-style-type: none"> • Select the Duvet Program on the Control panel. 	
<p style="text-align: center;">Eco Cotton</p> <p>Eco Cotton is the program for normally soiled cotton material and designed to minimize water consumption. Light weight bulky loads, may require the water level to be increased manually as the machine will perceive this to be the same as a small load</p>			 <ul style="list-style-type: none"> • Select the Eco Cotton Program on the Control panel. 	

	Close the lid	Finish	Caution & Note
 <ul style="list-style-type: none"> The washing tub rotates for 40 seconds to detect the laundry load Then the Water Level and the amount of Detergent to be used will be shown and water will be supplied. 	 <ul style="list-style-type: none"> Water will be supplied for 2 minutes after the start of the wash to supplement the water the laundry has absorbed. 	 <ul style="list-style-type: none"> When the wash program ends, the buzzer will chime for 10 seconds before the Power goes off automatically. 	<ul style="list-style-type: none"> If water is already in the tub, or wet clothes are loaded before starting, it will increase the Water level as it will sense this as a heavy load. With lightweight bulky loads, the Water Level will be selected to the lowest level. it should be manually increased. Changes to Water Temperature (Hot/Cold) and wash level are possible during operation. (refer to page 14)
			<ul style="list-style-type: none"> When setting the Water Level manually, do not set to a lower level than that which the machine has selected automatically. to prevent damage to the clothes. Washing with Hot water may damage the clothes (Water is set to cold automatically). Ensure that the load is under 2 kg. In order to avoid damage to laundry, the spin cycle may appear slow. This also avoids wrinkles and clothing may still contain some water. This is normal
			
			
			<ul style="list-style-type: none"> There are several times that the bowl will spin slowly during the wash. This is not a malfunction. it is part of the wash action. The energy efficiency label program set at WTG8520 : Set program of Eco Cotton, Temp. Warm, water level 4, Wash 25 min, Rinse 2, Spin High and test accordance or in conformity with standard and AS/NZS 2040.1

Washing Program	 POWER	Add the laundry	 Program	Add the detergent
<p>Silent</p> <p>Use this Program to wash quietly especially during late night and early morning.</p>			 <ul style="list-style-type: none"> Select the Silent Program on the Control panel. 	 <ul style="list-style-type: none"> Add the appropriate quantity of Detergents as indicated by the Water Level next to Water Detergent. Or follow the Detergent manufacturer's instructions
<p>Pre Wash+ Cotton</p> <p>Washing laundry with the Cotton cycle that pre treats stains, without hand washing first could cause odours to occur.</p>			 <ul style="list-style-type: none"> Select Pre Wash+ Cotton Program on the Control Panel. 	 <ul style="list-style-type: none"> Add the appropriate quantity of Detergent as indicated by the Water/ Detergent level indicator. Or follow the Detergent manufacturer's instructions

	Close the lid	Finish	Caution & Note
			<ul style="list-style-type: none"> Silent Program takes a longer time to wash than the Cotton program To reduce noise in spinning, the spin rpm is lower than normal spinning rpm. So the clothes will have more moisture remaining than normal.
			

Soak Wash

Use this mode to wash normal clothes or thick and heavy clothes which are excessively dirty. soak mode can be used with Cotton, Duvet, Silent, Eco Cotton Program

1 Press the **POWER** button to turn power on.



2 Press the Program button to select the washing Program

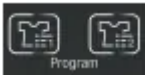

- Soak will not work in Wool and Quick wash, Pre Wash + Cotton program or the Tub Clean Function

3 Press the Wash button, to select Soak Program.

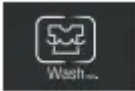

- Press the Wash button until the light turns on 'Soak' and 'Wash' indicators together as in the below image.



4 Add the Detergent

- The suggested quantity of Detergent is indicated next to the Water Level indicator.



5 Add the clothes and press the START/PAUSE button

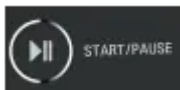

- The WATER LEVEL and the recommended amount of Detergent to be used will be shown and water will then enter the tub.

6 Close the lid.

- Water will be supplied after the start of the wash to supplement the water the clothes has absorbed. (water supply time depended on water level)

Finish

- When the wash Program ends, the Beeper will chime for 10 seconds before the Power goes off automatically

Additional Function Program

Tub Clean

If scrub is allowed to build-up in the machine it can result in stains on your clothes or unpleasant smell in your washer.

Scrud is the waxy build-up that can occur within any washer when the fabric softener comes into contact with Detergent in conjunction with excessive soap usage and cold water. The Tub Clean function can help reduce and may even prevent scrud build up. By cleansing the inner and outer bowl.

1 Press the **POWER** button to turn power on.



2 Press the Program button to select the Tub Clean Program.

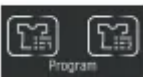

- * Ex-Large Water is set automatically.

3 Press the START/PAUSE button.

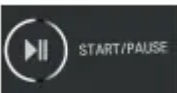

- Left time is displayed.

4 After 10 minutes of water supplement. Add the oxygenated bleach (about 300 ml).

- Do not use the Detergent box.
- Do not place any laundry inside tub.
- Do not use the Detergent dispenser drawer

5 Close the lid.

NOTE

- When the lid is open the machine will not operate, and a chime sound will remind you to close the lid.
- Before using this Program remove lint inside the lint filter.
- When using this Program, do not place any laundry inside the tub.
- After using this Program, remove dirt inside the lint filter.
- After finishing this Program, open the washer's lid to remove irritant odor. Do not pour bleach into the tub directly. It can cause damage the tub.

- Do not leave diluted oxygenated bleach inside tub for long time as this may cause the tub to rust and corrode.
- The remaining diluted oxygenated bleach water must be drained out.
- Use this Program once for every month.
- Do not use this Program repeatedly.

Air Spin

Air Spin the clothes to help reduce moisture levels before properly drying the clothes. This can be used when drying clothes is not immediately possible. this function can also be used to dry out the tub to prevent odours and mold.

1 Press the POWER button to turn power on.



2 Press the Air Spin button to select the desired timing.



Press Spin for 3 seconds to select Air Spin

- Other function cannot be selected during Air Spin.
- Automatically set to 30 minutes upon selection.
- Press Spin button again to select duration (30 min. ► 60 min ► 90 min ► 120 min)

Function	Air Spin			
Display	18:30	18:00	18:30	18:00
Time	30 min.	60 min.	90 min.	120 min.

- To deselect Air Spin, Press the POWER button.

3 Press the **START/PAUSE** button.

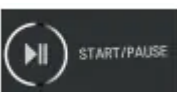

4 Close the lid.

NOTE

- Select "Air Spin" 30 min.
- Use this mode to keep inner tub from getting moldy caused by remaining moisture.
- Do not place any clothes inside the tub.
- Use this mode once a week.

Caution) For a more effective cleaning performance, temporarily, put the drain hose down to the floor so that water inside will be completely drained out. Be sure to re position the drain hose to its correct upright location immediately afterwards to prevent a malfunction.

- Select "Air Spin" above 1 hour
- Use this mode to reduce the drying time by minimizing remaining moisture on the laundry.
- In general, this is very effective on synthetic items(100% polyester).
- Evenly distribute the laundry before starting.(Under 2 kg.)
- For normal clothes: Select 1 hour.
- For synthetic items (100% polyester): Select 120 min for best results.



Option Washing

When you only need the Wash, Wash/Rinse or Rinse cycles, these can be set manually.

1 Press the POWER button to turn power on.

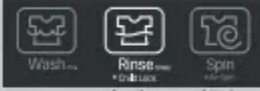
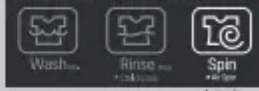

2.

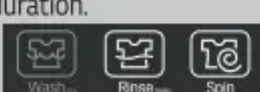
Only Wash	Only Rinse	Only Spin
<p>Press the Wash button, select the desired wash time.</p>  <p>1)Select Lamps On 2)select Lamps Off 3)Select Lamps Off</p>	<p>Press the Rinse button to select the desired amount of rinse.</p>  <p>Lamps Off 1)select Lamps On 2)Select Lamps Off</p>	<p>Press the Spin button to select the desired Spin duration.</p>  <p>Lamps Off Lamps Off 1)Select Lamps On</p>
Only Wash,Rinse	Only Rinse,Spin	Only Drain
<p>Press the Wash and Rinse buttons to select the desired wash time and amount of rinses.</p>  <p>1)Select Lamps On 2)select Lamps On 3)Select Lamps Off</p>	<p>Press the Rinse and Spin buttons, select the desired amount of rinse and spin duration.</p>  <p>Lamps Off 1)select Lamps On 2)Select Lamps On</p>	<p>When you want to drain only, select any Spin, and wait until the water has drained completely before turning the machine off.</p>



3 Press the **Water Level** button, to select the water level according to the amount of laundry. If you do not select anything, it will set to the middle water level automatically. Manually increasing the water level may be required to reduce linting and tangling if the load is bulky but lightweight.



4. Add the clothes into the wash tub.

5 Press the START/PAUSE button.

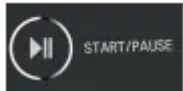

6 Add the detergent and close the lid.

NOTE

- **When a Wash or Rinse only option** is selected, after the wash is completed the water will not be drained out. If you wish to drain the water, press SPIN button and wait until water in the tub has drained completely. Then press the START/PAUSE button.
- If you do not specify the water level, then Medium will be automatically selected.
- If only Rinse is selected, the process will start from the water filling sequence..

Delay Start (Reservation) Wash

Delay Start (Reservation) Wash is used to delay the finishing time of the operation. The hours to be delayed can be set by the user accordingly. The time on the display is the finishing time, not the start time.

1 Press the POWER button to turn power on.



2 Press the Program button to select the washing Program.

- Select the appropriate program for the clothes on the Control panel. The Delay Start option will not work in Wool and Tub Clean Program



3 Press the **Delay (Reservation)** button.



- The 'Delay' indicator will turn on and 'Time Left' will be shown in the display. 

- Press the button repeatedly to set the desired finishing time. For example, To finish washing in 9 hours from now, make the display show 9:00 by pressing the Delay button repeatedly.

(RES. = Delay)  → 

4 Add the powdered Detergent.

- Add the appropriate quantity of powdered Detergent into the dispenser drawer. do not use liquid detergent as it will dispense prematurely and cause odors.
- When the lid is open the machine will not operate, and an alarm chime will remind you to close the lid.

5 Add the clothes and press the **START/PAUSE** button.

- When you press the START/PAUSE button the Delay indicator will blink.

6 Close the lid.

- The Delay lamp will blink and the remaining time will be displayed

Finish

- The washing will be finished according to the delayed time.

NOTE

- Finishing time can be delayed from 3~ 18 hours. Delaying 3~ 12 hours can be done in 1 hour time intervals and from 12~ 18 hours in 2 hour time intervals.
- If the lid is open, the machine will not work, and an alarm signal will alarm to remind you to close the lid.
- To select washing time, rinsing times, spinning time, water level, hot/cold or wash power manually, press the Delay Start (Reservation) button and select the desired options. Then press the START/PAUSE button.
- When the clothes cannot be taken out immediately after the wash program ends, it is better to omit the spinning program. (The laundry will be wrinkled if left for a long time after spinning.)

Other Useful Functions

Child Lock Function

If you want to lock all the keys to prevent settings from being changed by a child, you can use the child lock option.

How to Lock

1 Press the **POWER** button



- Turn Power on.

2 Press the **START/PAUSE** button to start washing.

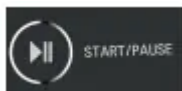

- After all washing conditions are set according to the manual.

Additional Function Program

3 Press and hold the Rinse button for 3 seconds to select Child lock.



- During the wash Program, all the buttons are locked until washing is completed or it is child-lock function is deactivated manually.

How to Unlock

If you want to unlock during wash, press the **Rinse** button and hold for 3 Seconds again.

NOTE

- "CL" & the remaining time are alternatively shown on the display while they are locked.

Beeper Option (some models only)

If you want to use the washing machine without alarm signal sounds, press Beeper buttons allow you to select: High Off Low High respectively. Default setting is High.

To make buzzer work, press both the Beeper buttons simultaneously one more time.

Seeing Remaining Time

To see the remaining time for each process, press one of the **Wash, Rinse** and **Spin** buttons. The remaining time for each process will appear for about 1 second.

Installation

Placing and Leveling

Please ensure that the lower transit restraint has been removed before operating your machine.

Caution

Improper installation of the washer may cause noise and malfunctioning.

1. The ventilation openings in the base area must not be obstructed by carpet when the washing machine is installed on a carpeted floor.

2. Install the washing machine on a solid, level surface. Do not install the washer on an elevated platform or surface.

1 Place the machine on a flat and firm surface which allows proper clearance.



We suggest a minimum clearance of 2 cm to the right side and left sides of the machine for ease of installation. At the rear, a minimum clearance of 10 cm is required.

NOTE:

If the washer is installed on a uneven, weak or tiled floor causing excessive vibration, spin failure or "UE" error can occur.

It must be placed on a firm and level floor to help prevent spin failure.

2 Check that the machine is level

Open the lid and look from above to see if it is same as shown.

Top view of machine



3 Leveling the machine

Lift the front of the washing machine and twist the Adjustable Leg until washing is placed evenly.



Connecting the Water Supply hose

Before connecting the Water Supply Hose to the water tap, check the hose type and then choose the correct instruction here under.

Note that the Water Supply hose supplied may vary from country to country, Make sure to connect the blue inlet hose to the COLD water tap, and the orange inlet hose to the HOT water tap.

Connecting Water Supply Hose to water tap

Normal Type (Normal tap without thread & screw type inlet hose.)

1 Untighten the screw.

Untighten the screw of the connector so that the tap can be placed in the middle.

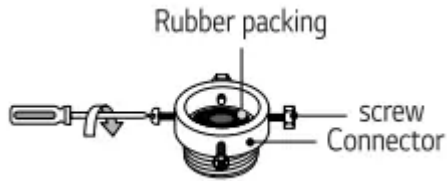

2 Fixing the connector to the tap.

Push the upper connector up till the rubber packing is in tight contact with the tap. Then tighten the 4 screws.

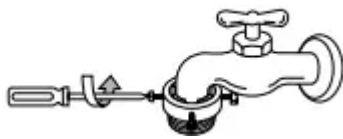

3 Attach the water supply hose securely to the connector.

Push the water supply hose vertically upwards so that the rubber seal within the hose can adhere completely to the tap.

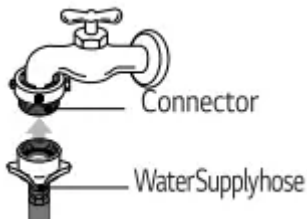

4 Fixing the connector to the water supply hose.

Attach the water supply hose to the connector and then tighten it by screwing it to the right.



5 Check the connection of water supply hose and the connector.

After connecting the hose, open the tap to check for any water leakage. If the water leaks, close the tap and start again from step 1



NOTE

The washing machine is to be connected to the water mains using new hose-sets and old hose-sets should not be reused.

Connecting the Water Supply hose

Normal Type (Normal tap without thread & one touch type inlet hose.)

1 Separate Middle connector from Water Supply Hose.

Separate Middle connector from the Water Supply Hose by pulling the Pressing Rod and the Pressing Handle that is attached to the Water supply Hose.

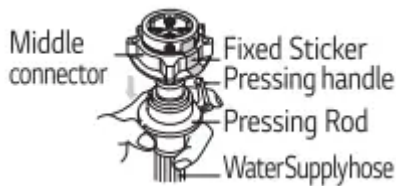

2 Loosen the fixed nuts to connect the connector to the tap.

Untighten the screw of the connector so that the tap can be placed in the middle.

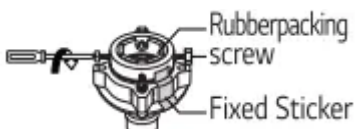

NOTE

In case tap is too large.

If the tap diameter is too large or is square, untighten the 4 screws and remove the guide plate. Then follow step 1.

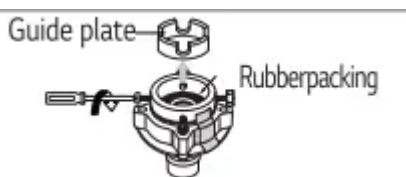

3 Fixing Connectors to the Tap.

Push the upper connector up till the rubber packing is in tight contact with the tap. Then tighten the 4 screws.



4 Fixing Upper Connector and Middle Connector.

Remove the fixed sticker in between the Upper and Middle Connectors.

Tighten the connectors by holding one connector and twist middle connector to the right.

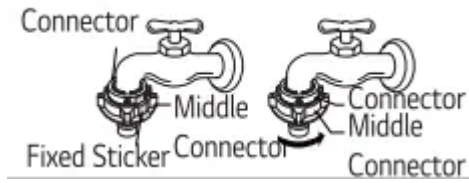

5 Connecting Middle Connector and Water Supply Hose.

Press down the pressing rod of the Water Supply Hose which was separated from middle connector (refer to Step 1) and then join it to the middle connector.

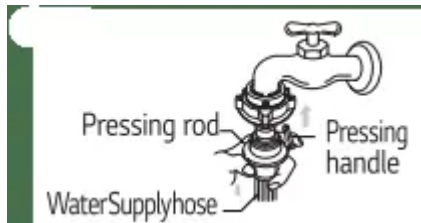

6 Check for water leakage.

After connecting the hose, open the tap to check for any water leakage. If the connection leaks, close the tap and start again from step 1. If you skip step 1, water leakage may occur.



Screw Type

1 Attach the water supply hose to the tap.

Push the water supply hose up so that the rubber washer within the hose makes contact with the tap. Do not install the hose if the black Water tap- washer is missing. Rubber washer
WaterSupplyHose

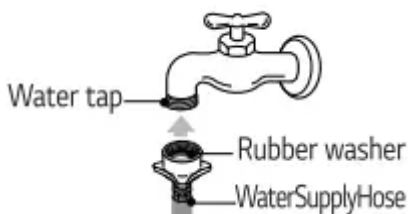

2 Connect the water supply hose to tap.

Connect the water supply hose to the tap and then tighten it by screwing it to the right. Do not over tighten, or use any mechanical tools to tighten. Hand tighten only. A soft cloth can be used to assist the hand tightening.



3 Check for water leakage.

After connecting the hose at both ends, open the tap to check for any water leakage.

Connecting Water Supply Hose to the machine

- Connect the water supply hose to inlet valve of the washing machine, and then tighten it by turning the hose connecting part.
- Check to ensure that the rubber washer is inside the connector

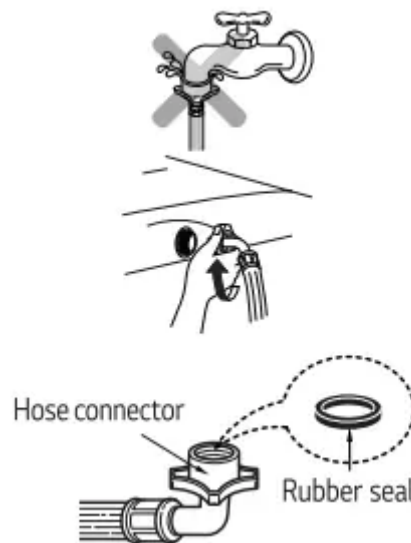

Connecting the Drain Hose

1 Fit the end of the drain hose to the outlet of the drain pump and secure the clamp.

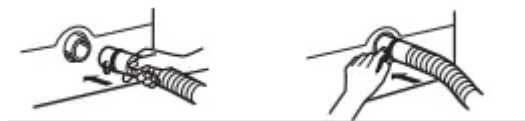

2 Put the other end of the drain hose over the standpipe or wash tub.

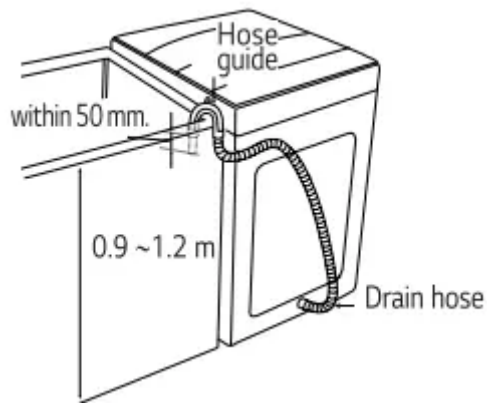

NOTE

- To Prevent siphoning, the drain hose should not extend more than 50 mm from the end of the hose guide
- The discharge height should be approximately 0.9 ~1.2 m from the floor. Do not lay the drain pipe on the floor as it will drain out any water in the machine.

1 Before connecting

Ensure that the hose clip is set as indicated here.

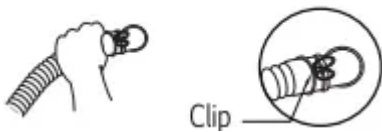

2 Connecting the elbow hose

Push the elbow hose toward the body of the washing machine.

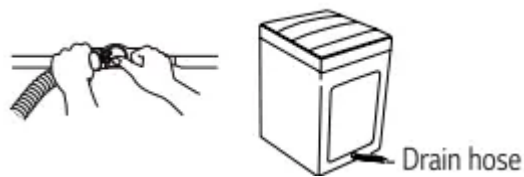

3 Placement of the Drain Hose

To change the direction of the drain hose elbow, squeeze the clamp, rotate the elbow to the desired direction, ensure the hose is pushed in all the way and then release the clamp. Repeat Step 2.



Grounding Method

Earth wire should be connected. If the earth pin of the plug is missing or is not connected, there is a possible danger of electric shock. The power cord is fitted with an earthing terminal and must be connected. Do not remove the earth pin or modify the plug.

Grounding Method with Ground insert space Terminal



If the AC current outlet has a ground terminal, then separate grounding is not required. Note that AC power outlet configurations may differ from country to country.

CAUTION concerning the Power Cord

Most appliances recommend they be placed upon a dedicated circuit; that is, a single outlet circuit which powers only that appliance and has no additional outlets or branch circuits. Check the specification page of this owner's manual to be certain. Do not overload wall outlets. Overloaded wall outlets, loose or damaged wall outlets, extension cords, frayed power cords, or damaged or cracked wire insulation are dangerous. Any of these conditions could result in electric shock or fire. Periodically examine the cord of your appliance, and if its appearance indicates damage or deterioration, unplug it, discontinue use of the appliance, and have the cord replaced with an exact replacement part by an authorized servicer. Protect the power cord from physical or mechanical abuse, such as being twisted, kinked, pinched, closed in a door, or walked upon. Pay particular attention to plugs, wall outlets, and the point where the cord exits the appliance.

Other Grounding Method (APPLICABLE TO SOME EUROPEAN COUNTRIES ONLY)

Buying Copper plate

Connect the Ground Wire to a Ground Copper plate and bury it more than 75 cm in the ground.

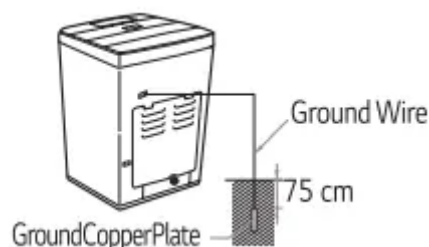

Using Ground Wire

Connect the ground Wire to the socket provided exclusively for Grounding.

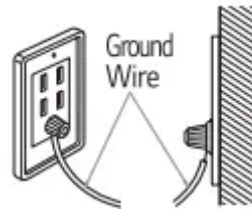

Using a Short Circuit Breaker

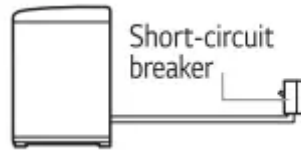

If grounding methods described above are not possible, a separate circuit breaker should be employed and installed by a qualified electrician.

Caution

- To prevent a possible explosion, do not connect ground to a gas pipe.
- Do not connect ground to telephone wires or lighting rods. This may be dangerous during electrical storms.
- Connecting ground to plastic has no effect.
- Ground wires should be connected when an extension cord is used.

Care and Maintenance

Cleaning and Maintenance

Cold water washing

- If you always use Cold water, we recommend that a Warm or Hot wash be used at regular intervals e.g. every 5th wash should be at least a Warm one.

When you have finished

- Turn off taps to prevent the chance of flooding should a hose burst.
- Always unplug the power cord after use. When water supply into the tub is not clean or the filter is clogged with particles (such as sand), clean the filter in the inlet valve occasionally.

(The power cord images and water tap may vary according to the country)

To Clean the Filter within the Inlet Valve

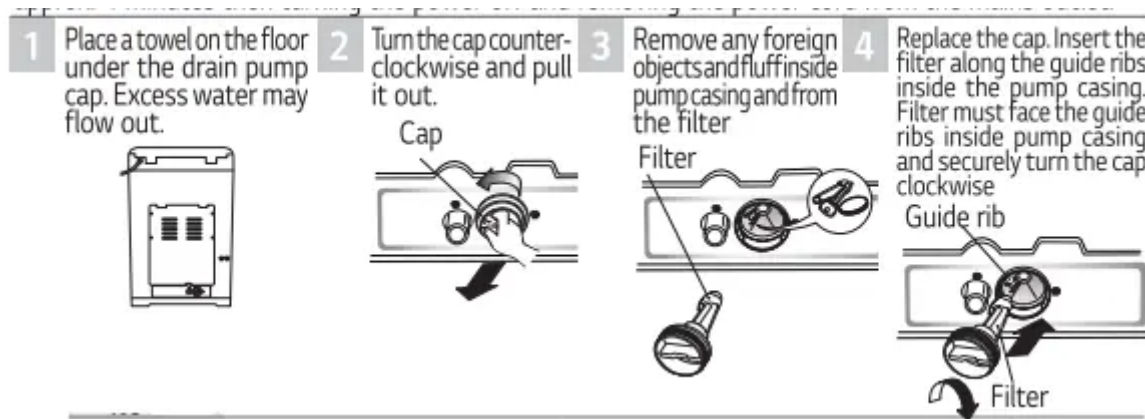

NOTE

- Before cleaning the filter, the impurities in the water supply hose should be removed.

To Clean the Lint Filter



Do **NOT** rotate the filter to remove it. Push down on the top release tab and pull the top of the filter out as it pivots from the bottom.

NOTE

- If the lint filter is torn or damaged, purchase a new one from an LG service center.

To Clean the Pump casting (for pump models) drain out all water first by engaging a spin cycle for approx. 4 minutes then turning the power off and removing the power cord from the mains outlet.

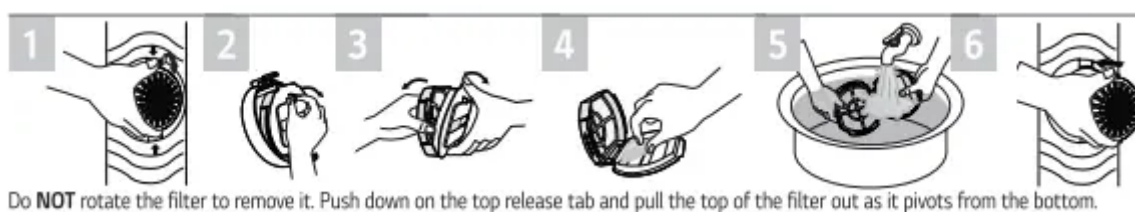

NOTE:

- Check if water leaks after reassembling. (The Rubber ring must remain on the cap)

When there is a fear of freezing

- Close the water taps and remove the Water Supply Hose.



- Remove the water which remains in the water supply.
- Lower the drain hose and drain any remaining water left in by spinning

If frozen

- Remove the water supply hose, and immerse it in Hot water at approx.. 40°C.
- Pour approx.. 2 liters of Hot water at approx.. 40°C, into the bowl and let it stand for 10 minutes.
- Connect the water supply hose to the water tap and confirm that the washing machine performs the supply and drainage of water.

Wash Inner-tub

Leave the lid open after washing to allow moisture to evaporate. If you want to clean the inner-tub use a clean soft cloth dampened with liquid dish washing Detergent, then rinse. (Do not use harsh or gritty cleaners.)

Inlet Hoses and Exterior

Hoses connection washer to faucet should be replace every 5 years. Immediately wipe off any spills. Wipe with damp cloth. Try not to hit surface with sharp objects. Do not use stain removal sprays or agents on, near or next to the machine. Doing so can damage the machines finish and cause corrosion

Long Vacations

Be sure water supply is shut off at the tap. Drain all water from hoses if weather will be below freezing.

Cleaning the Inside of your Washer

If you use fabric softener or do regular Cold water washing, it is very important that you occasionally clean the inside of your washer.

- Fill your washer with Hot water.
- Add about two cups of powder detergent that contain phosphate
- Let it operate for several minutes.
- Stop the washer, open the lid leave it to soak overnight.
- After soaking, drain the washer and run it through a normal cycle.

Or use Tub Clean Program periodically. We do not recommend that you wash clothes during this procedure.

Products that might damage your washing machine

- Concentrated bleaches and nappy sanitizer will cause damage to the paint work and components of your washer.

- Hydrocarbon solvents i.e. petrol, paint thinners and lacquer thinners, etc. can dissolve plastic and blister paint (Be careful when washing garments stained with these solvents as they are flammable DO NOT put them in washer or dryer without presoaking and rinsing them first.)
- Some pretreatment sprays or liquids can damage your washer's control panel.
- Use of dyes in your washer may cause staining of the plastic components. The dye will not damage the machine but we suggest you thoroughly clean your washer afterwards. We do not recommend the use of dye strippers in your washer.
- Do not use your washer lid as a work surface.

Troubleshooting

Soft safety Door

- Using tempered glass, the inside of the tub can be seen while washing with the door closed.
- To prevent the door from dropping suddenly, it uses smart hinges so the door closes softly.
- The door is heavy and should not be forced closed. Be careful not to let hands or any other materials get caught. It might cause injury or damage the product. Do not place or store any items on top of the door when it is closed or when the machine is not in use.



Common washing problems

Com Many washing problems involve poor soil & stain removal, residues of lint and scum, and fabric damage. For satisfactory washing results, follow these instructions.

WASH PROBLEM

Poor soil, Removal

- Not enough Detergent
 - Use correct amount of Detergent for load size, amount of soil and water Hardness.
- Wash water temperature too low.
 - Use Warm or Hot water for normal soil. Different Water Temperature may be required according to soil type. (Refer to page 10)
- Overloading the washer
 - Reduce load size.

- Incorrect wash cycle
 - Wash with Duvet or PreWash+Cotton or Soak & Duvet wash cycle for heavy soiled laundry.
- Incorrect sorting
 - Separate heavily soiled items from lightly soiled ones.
- Do not pretreated stain
 - Pretreat stain and heavy soil according to directions shown on Page 9

Blue Stains

- Undiluted fabric softener dispensed directly onto fabric
 - Rub the stain with bar soap. Wash.
 - Do not overfill fabric softener dispenser and do not pour liquid fabric softener directly onto fabric. See page 12 for more instructions.

Black or gray marks on clothes

- A buildup caused by the interaction of fabric softener and Detergent can flake off and mark clothes
 - Keep the recommendations against Scrub (waxy buildup).(refer to scrub page 12.)
- Not enough Detergent
 - Use correct amount of Detergent for load size, amount of soil and water Hardness.

Yellow or brown rust stains

- Iron or manganese in water supply, water pipes,or waster supply, water heater
 - To restore discolored load of whites, use rust remover safe for fabric.
 - Install non precipitating water softener or an iron filter in your water supply system for an ongoing problem.
 - Before washing, run water for a few minutes to clear lines.

Lint

- Incorrect sorting
- Tissues left in pocket
 - Wash lint givers eg towels, flannelette, sheets, separately from lint collectors eg synthetic fabrics and remove tissues in pockets before wash. See page 9 for sorting and caring before loading.

- Overloading the washer.
 - Do not overload the washer.
- Not enough water in the tub
 - Manually increase the water level if the load is lightweight but bulky.

Residue or Detergent

- Overloading the washer
 - Do not overload the washer.
- Un dissolved Detergent
 - Some Detergents need to be per-dissolved, check the Detergent instructions. Try pre-dissolving the Detergent.
- Use too much Detergent
 - Increase Water Temperature using HOT water safe for fabric.
 - Use proper amount of Detergent.

Holes, tears, Or snags

- Incorrect use of chlorine bleach.
 - Never pour chlorine bleach directly on fabric. See page 11 for adding liquid bleach.
- Unfastened zippers, hooks, buckles
 - Fasten zippers, hooks, and buckles.
- Ribs, tears and broken threads
 - Remove objects in pockets. See page 9 for caring before loading.
 - Do not overload the washer.
- Overloading the washer
- Degradation of fabric

Before calling for service, check the problem against the list belows.



Water Supply Failure

- The water taps may be turned off?
- Is the water supply cut off?
- Is the tap or water supply hose frozen?
- Is the water pressure too low or too high, or is the filter of the inlet valve clogged with impurities?

- Is the Hot hose connected to cold?
- Is the Cold hose connected to hot?
- Ensure the drain hose is not laying on the ground.

Drainage Failure

- Is the drain hose positioned correctly?
- Is the drain hose bent or placed too high?
- Is the internal part of the hose or drain pump (only pump model) clogged with impurities?
- Check if electric power has gone off.

Spin Failure

- Is the load evenly balanced?
- Is the washing machine placed on a flat surface?
- Press the "Start/Pause" button to release the UE, now distribute the laundry evenly and then press the "Start/ Pause" button again to resume the cycle.

Door(Lid) Open

- Is the lid closed?

Internal sensing failure

Overflow failure

Motor locking

- Please call your nearest LG Electronics service center for help.

SmartDiagnosis™

1 Close the washer door, and press the POWER button.

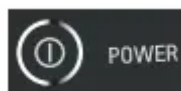

- If you manipulated other button or dial before pressing Temp. button, turn off the power and start again from the beginning.

2 Place the phone to SmartDiagnosis™ display.



- Make sure that the speaking side of the phone to face SmartDiagnosis™ display



3 Long press **Temp.** button to activate smart diagnosis.



- Place the phone near the **SmartDiagnosis™** Display, and long press Temp button until tak tak tak sound.

Note: Before pressing the Temp. should turn the power button for reuse if you have made other operations. If under the condition "CL" uninstall it, and reconnect the power



4 Hold the phone while data is transmitted.



- Keep placing phone to **SmartDiagnosis™** display while data for smart diagnosis is being transmitted. The time remaining for data transmission will be displayed on screen.
- Transmission sound may be irritating. For proper diagnosis, do not take off the phone. You can press power button to stop diagnosis function and the sound.

5 After the data transmission is completed, listen to the diagnosis result from the consultant.



- When data transmission is completed, the power is automatically turned off with "End" display after a few seconds.

NOTE:

Smart Diagnosis is a troubleshooting feature designed to assist, not replace, the traditional method of troubleshooting through service calls. The effectiveness of this feature depends upon various factors, including, but not limited to, the reception of the cellular phone being used for transmission, any external noise that may be present during the transmission, and the acoustics of the room where the machine is located. Accordingly, LG does not guarantee that smart Diagnosis would accurately troubleshoot any given issue.

Blanket Folding Method

The blanket and Large size cloth washing method

The Clothes should not exceed 160x200 cm (Width x Length)

1 Fold the blanket in half along the length.



2 Fold the blanket into 3 parts, by a left-width around 30 cm.

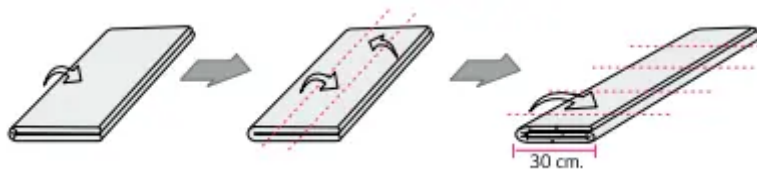

3 Roll the blanket before put in the tub.

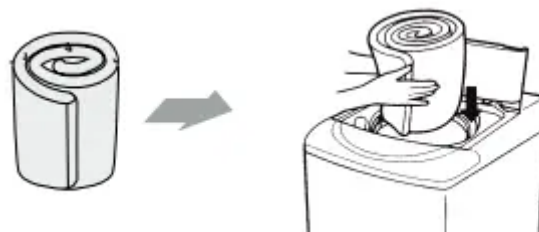

4 When input the clothes in the tub, the clothes should not over balance lower otherwise, it may cause damage to the blanket.



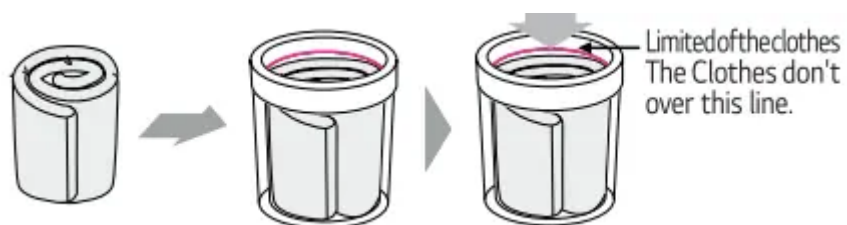

Specification



Model	WTG8520
Capacity	8.5 kg
Power Supply	220 - 240 V~, 50 Hz
Rate input	200 W
Water tap pressure	30 - 800 kPa (0.3 - 8.0 kgf / cm ²)
Weight	44.5 kg
Size	632 (W) x 670 (D) x 1020 (H) mm.

*In our continuing effort to improve the quality of our appliances, it may be necessary to make changes to the appliance without revising this manual.

Warning

This content is compiled from multiple sources and is provided for reference purposes only. It may not be complete or fully applicable to all situations. If you are unable to resolve your issue, please contact the product manufacturer or an authorized service provider for official support.

Document generated by [ManualsFile](#)

