

USING THE WASHER

Getting started

WARNING To reduce the risk of fire, electric shock, or injury to persons, read the **IMPORTANT SAFETY INSTRUCTIONS** before operating this appliance.

Throughout this manual, features and appearance may vary from your model.

Step 1 **IMPORTANT:** See the dispenser section in this manual.

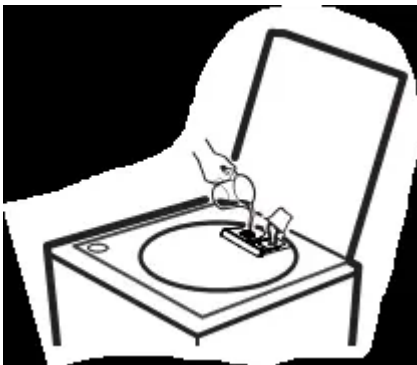

- Add fabric softener to the fabric softener dispenser.
- Add the manufacturer's recommended amount of detergent. GE Appliances recommends the use of High Efficiency detergents such as  in your energy efficient washer. Place detergent pods in the bottom of the wash basket before adding clothes.

Step 2



- Loosely add items around Infusor. Overloading may negatively impact wash performance. See page 10 for suggested loading examples.
- Close lid.

NOTE: The washer will not start with lid open.

Step 3



- Select wash cycle.
- Select wash options, including Deep Rinse option when using fabric softener.
- Select options.

Step 4



- Press Start.

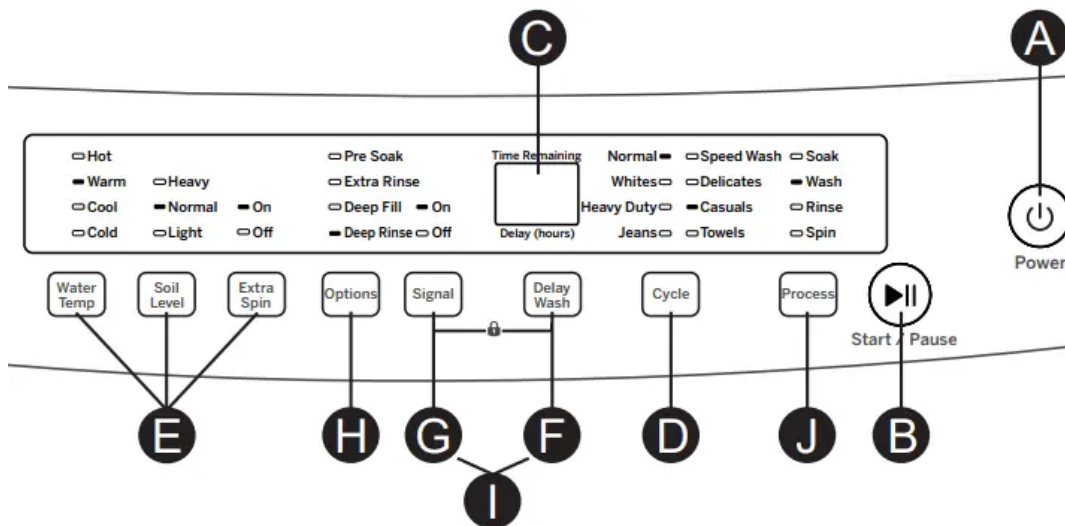

A Power

Press Power to “wake up” the display. If the display is active, press Power to put the washer into idle mode.

NOTE: Pressing Power does not disconnect the appliance from the power supply.

B Start/Pause

Press Start to begin the cycle. If the washer is running, pressing it once will pause the washer.

C Display

The display shows the approximate time remaining until the end of the cycle. NOTE: The cycle time is affected by how long it takes the washer to fill. This depends on the water pressure in your home. The size of the load being washed also significantly impacts cycle time, with larger loads taking longer.

D Cycle

Press the Cycle button to select the desired cycle.

The chart below will help you match the items to be washed with the best wash cycle settings. For optimal performance, select the cycle that most closely matches the items being washed.

E Settings

Individual settings for agitation (Soil), water temperature (Temp), and spin (Extra Spin) can be set from the minimum (lowest in column) to maximum (highest in column). In general, the higher up the column, the more washer energy will be used.

NOTE: Extra Spin typically reduces dryer time/energy usage (i.e. reduces total energy when using both a washer and a dryer).

F Delay Wash

Press Delay Wash to choose the number of hours you want to delay the start of the cycle, and then press Start/Pause.

The washer will count down and start automatically at the correct time.

G Signal

To turn the signal sounds on/off, press Signal.

H Cycle Options

Extra Spin

Set this option to increase the spin time of the cycle.

Pre-Soak

Select the Pre-Soak feature to add a soak step following the fill portion of the cycle.

Extra Rinse

When you use extra detergent or bleach to clean heavily soiled clothes, use the Extra Rinse option to better remove additional residues.

Deep Fill

Select the Deep Fill feature for loads where extra water is needed. The Deep Fill feature is recommended for special case loads only, not for typical use. NOTE: This option is not allowed for some cycles.

Deep Rinse

Set this option to provide a deep rinse or when using fabric softener.

I Control Lock

Use the control lock before or during a cycle to prevent any selections from being made.

To lock/unlock the washer controls, press and hold the Signal and Delay Wash buttons for 3 seconds.

J Process

Choose the wash processes to include in the cycle. Press Process until all the processes you want to include are lit. More than one process can be selected.

Soak

Select to set a soak process only. Washer basket will fill, soak, and drain.

Wash

Select to set a wash process only. Washer basket will fill, wash, and drain.

Rinse

Select to set a rinse process only. Washer basket will rinse and spin.

Spin

Select to set a spin process only. Washer basket will spin.

Consumer Help Indicator

Your washer is equipped with Consumer Help Indicator (CHI). CHI is our way to communicate a simple remedy for some situations that you can perform without the need to call for service. The chart below describes the helpful messages you may notice on your display when you return to start another load. These messages will provide simple remedies you can quickly perform.

Spin light blinking	If an out-of-balance condition is detected by the washer, the Spin light will blink during the remaining portion of the cycle and will stay illuminated for a short time after cycle completion. When this occurs, the washer is taking actions to correct the out-of-balance condition and complete the cycle normally. In some cases, the washer may not be able to balance the load and spin up to full speed. If you notice the load is more wet than normal at the end of the cycle, redistribute the load evenly in the wash basket and run a Spin cycle. To run a Spin cycle, select the Normal cycle and press the Process button until only the Spin light is on.
"	Check your house water supply. Did you forget to turn on one or both supply valves after installation or coming back from vacation?
"	Indicates the lid is open. Close the lid.
"	Indicates the laundry load is unbalanced. Reposition laundry evenly in basket, and ensure washer is level.
"	Indicates water has reached a critical level. Turn off water and power to the washer and call service.

Detergent Dispenser

HE detergent should be added to the left side of the dispenser drawer.

For liquid detergent, leave cup in drawer.

For powder detergent, remove left cup (two parts) from drawer.

Follow the detergent manufacturer's recommendations for the correct amount of detergent, based on load size, taking care to add detergent to the left compartment. Do not overfill or dilute detergent as this can result in additive being dispensed prematurely in the wash cycle. Your option selections will determine when detergent is automatically dispensed at its optimal time in the wash cycle. For optimal performance, especially when selecting cooler temperature and in cold weather climates, place powdered HE detergent directly in the wash basket before adding clothes.

NOTE: Single-dose laundry packets should not be added to the dispenser drawer, as they will not dispense properly. Put packets in bottom of wash basket.

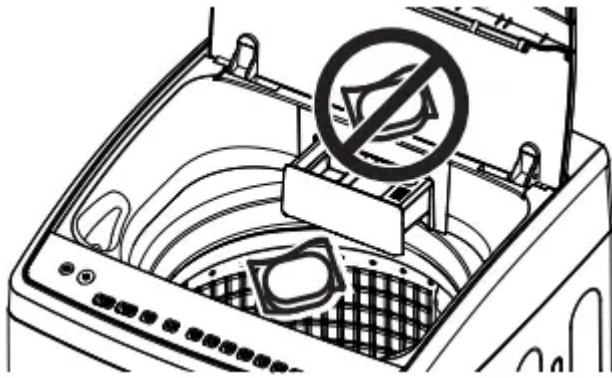

For liquid detergent, leave cup in drawer, and pour into left cup/compartment.

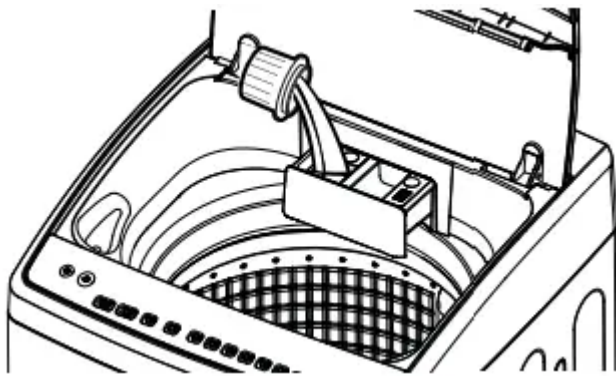

For powder detergent, remove left cup (two parts) from drawer, and pour into left compartment.

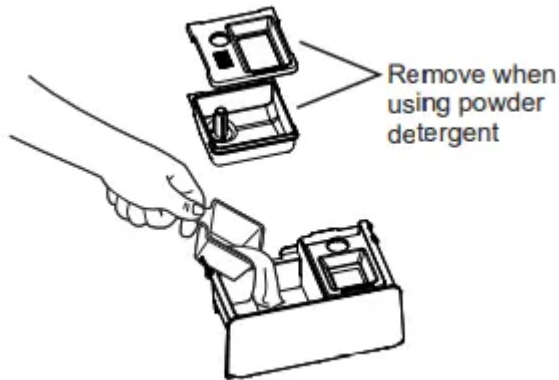

Liquid Fabric Softener/Conditioner Dispenser

Deep Rinse should be selected when using fabric softener.

Liquid fabric softener/conditioner should be added to the right side of the dispenser drawer. Follow the liquid fabric softener/conditioner manufacturer's recommendations for the correct amount of softener/conditioner, based on load size, taking care to add softener/conditioner to the right compartment. Do not overfill or dilute softener/conditioner as this can result in additive being dispensed prematurely in the wash cycle. Your option selections will determine when liquid fabric softener/conditioner is automatically dispensed at its optimal time in the rinse cycle.

NOTE: Fabric softener crystals should NOT be added to the dispenser drawer, as they will not dispense properly.

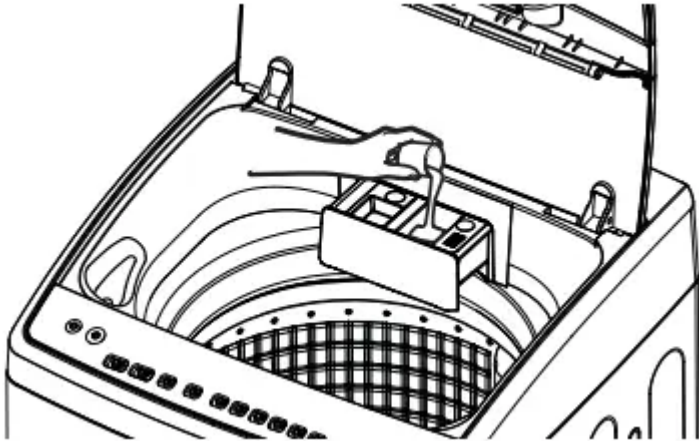

Liquid Bleach Dispenser

Liquid chlorine bleach should be added through the bleach dispenser in the front left corner. Follow bleach manufacturer's recommendations for the correct amount of liquid chlorine bleach based on load size, taking care to not apply or spill it directly on clothing.

NOTE: Do not use liquid chlorine bleach and laundry pretreatments such as an Oxi product in the same wash load.

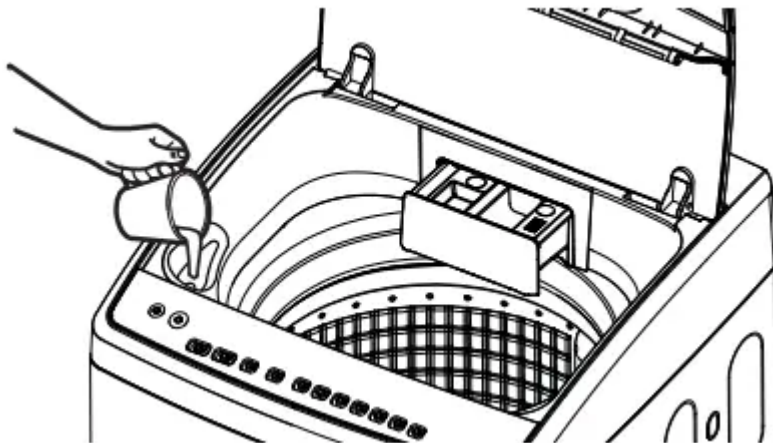

LOADING

Loading

Always follow fabric manufacturer's care label when laundering.

Automatic Load Sensing

This determines the correct agitate profile, agitate duration and amount of water suited to the size and type of load placed in the washer. The washer will not start the wash cycle or fill

with water if the lid is open. When the lid is closed the machine is able to begin filling with water in order to sense the load size.

NOTE: Automatic load sensing initiates pulses of the motor at the beginning of the cycle. This is normal operation.

NOTE: This is a high efficiency washing machine. This system requires less water while providing effective cleaning action. You may notice that the water level is lower than on your previous washer. This is normal for a high efficiency washer.

Pretreatment

Place laundry pretreatments, such as an Oxi product, directly in the bottom of the wash basket before loading clothes.

NOTE: Do not use liquid chlorine bleach and laundry pretreatments such as an Oxi product in the same wash load.

Proper Use of Detergent

Using too little or too much detergent is a common cause of laundry problems.

Use less detergent if you have soft water, a smaller load or a lightly soiled load.

For spots, apply pre-treatment to items as recommended on the product label. Application should be made in the basket to prevent overspray which may cause the coloring on the lid or graphics to fade.

Place detergent pods in the bottom of the wash basket before adding clothes.

GE Appliances recommends the use of High Efficiency detergents such as  in your energy efficient washer. HE detergents are formulated to work with low water wash and rinse systems. HE detergents reduce the oversudsing problems commonly associated with regular detergents.

When using high efficiency or concentrated detergents, consult the product label to determine amount required for optimum performance. Excessive detergent will negatively impact wash performance.

Sorting Wash Loads

Sort by color (whites, lights, colors), soil level, fabric type (sturdy cottons, easy care, delicates) and whether the fabric produces lint (terry cloth, chenille) or collects lint (velveteen, corduroy). Wash lint producers such as cotton towels and socks separate from lint collectors including synthetic garments and dress pants.

Loading the Washer

Load dry items loosely in the washer basket. For best results, load items evenly and loosely around the outside of the basket, filling in towards the center on larger loads. To add items after

washer has started, press Start/Pause. Lift the lid and submerge additional items around the outside of the basket. Close the lid and press Start to resume.

- Do not place large items such as sheets, blankets and towels across the Infusor. Load them around the outside of the basket.
- Do not put lawn or sofa cushions into the washer as they are too big to move. Remove outer covers and ONLY wash them.

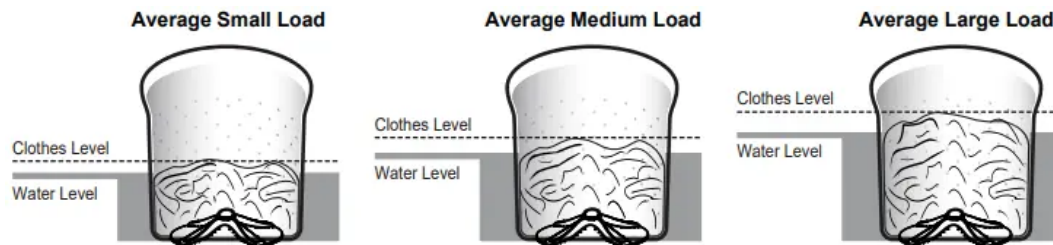

Care and Cleaning

Exterior of the Washer

Immediately wipe off any spills with a damp cloth.

Interior of the Washer

To clean the interior of the washer, select the Whites cycle and Deep Fill option on the control panel. A basket clean cycle should be performed, at a minimum, once per month. This cycle will use more water, in addition to bleach, to control the rate at which soils and detergents may accumulate in your washer.

NOTE: Read the instructions below completely before starting the basket clean cycle.

1. Remove any garments or objects from the washer and ensure the washer basket is empty.
2. Open the washer lid and pour 1/2 cup or 125 ml of liquid bleach or other washing machine cleaner into the basket.



3. Close the lid, select the Whites cycle, and the Deep Fill option. Push the Start button.
4. When the basket clean cycle is working, the display will show the estimated cycle time remaining. Do not interrupt the cycle.

If interrupted, be sure to run a complete basket clean cycle before using the washer.

IMPORTANT:

- Run this cycle with 1/2 cup (125 ml) of bleach once a month.
- After the completion of a basket clean cycle, the interior of your washer may have a bleach smell.

Lint Filter

Clean EVERY MONTH to remove any items that may have been caught in the filter.

1. Remove the blue lint filters from the side of the basket by unclipping.
2. Open the filter, gently remove lint, rinse filter in warm water, and close.
3. Replace by snapping filter back into its location in the washer basket.

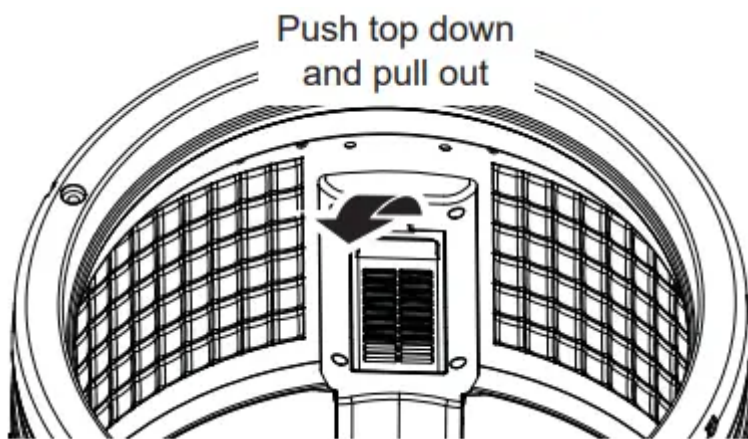

Dispenser Drawer

After some period of use, a small amount of detergent or softener residue may be present in the dispenser drawer. The drawer can easily be removed for cleaning. To remove the drawer, pull it out until the drawer stops and then lift up on the front of the drawer. The drawer can then be removed from the dispenser box. Wash the drawer in warm, soapy water using a mild detergent. Rinse drawer with warm water. If cups are removed for cleaning, be sure to push cups fully back into place after cleaning.

The dispenser drawer and cups are not dishwasher safe. The dispenser box is not removable, but it can be wiped clean using a damp cloth if necessary. Do not attempt to remove the dispenser box for cleaning.

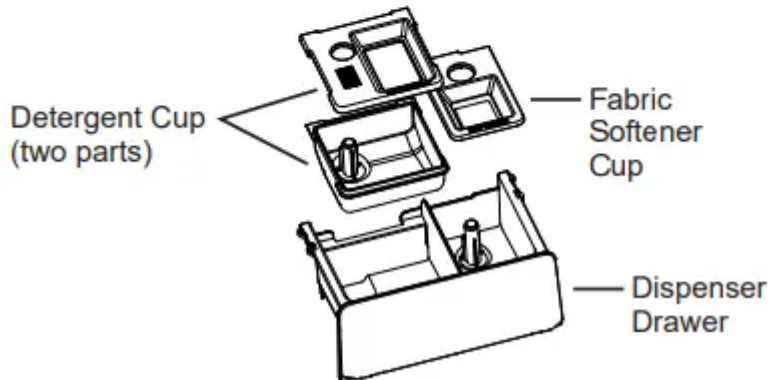
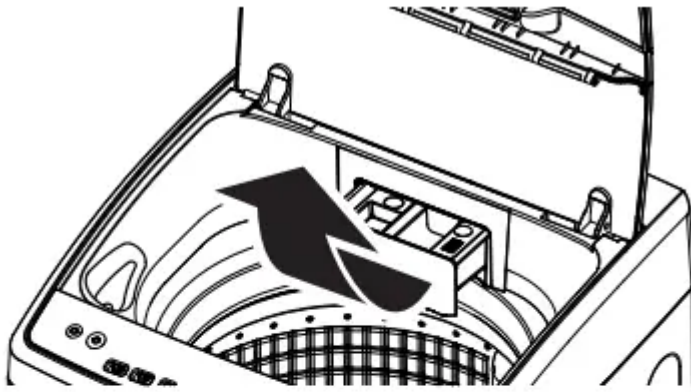

Inlet Water Valve Screen(s)

If the flow of entering water into the washer is slow, the inlet water valve screen(s) may be clogged.

Check and clean inlet valve screens EVERY SIX MONTHS.

1. Turn off water valve(s).
2. Disconnect water hose(s) from the back of the washer.
3. Remove the screen(s), clean with a brush and replace.
4. Replace the hose(s).
5. Turn water valves on.
6. Check for leaks, tighten if necessary.

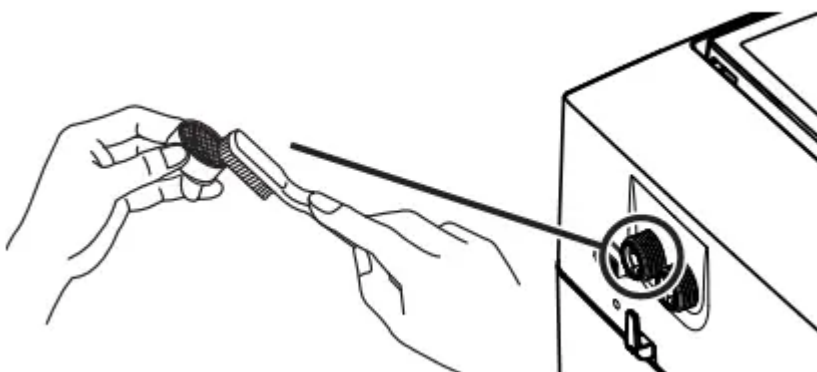

Water Supply Hoses

Hoses connecting washer to faucet should be replaced every 5 years.

Long Vacations

Be sure water supply is shut off at faucets. Drain all water from hoses and water filter pump area if weather will be below freezing.

Moving and Storage

Ask the service technician to remove water from drain pump and hoses. Do not store the washer where it will be exposed to the weather.

TROUBLESHOOTING TIPS

Troubleshooting Tips... Before you call for service



Problem	Possible Causes	What To Do
Small amount of water remaining in dispenser (on some models) at end of cycle	Normal dispenser operation	It is normal for a small amount of water to remain in the dispenser drawer after the cycle. To empty water from dispenser drawer, pull out the dispenser drawer and dump water into washer basket or sink. Empty the dispenser prior to putting detergent into dispenser for next cycle.
Water level seems low	This is normal	Water may not cover the top level of the clothes. This is normal for this high efficiency washer.
Low water flow	Water valve screens are stopped up	Turn off the water source and remove the water connection hoses from the upper back of the washer and the hot and cold faucets. Clean both the hose screens (if so equipped) and the screens in the machine using a brush or a toothpick. Reconnect the hoses and turn the water back on. Check for leaks. Ensure there are no leaks at the connections.
Water siphoning out of washer	Drain standpipe is too low or hose too far into standpipe	The drain hose must exceed 30" height at some point above the washer back and the drain pipe. Use anti-siphon device. See the Installation Instructions .
Too many suds	Soft water	Try less detergent.
	Too much detergent	Measure your detergent carefully. Use less soap if you have soft water, a smaller load or a lightly soiled load.
	Type of detergent	Switch to High Efficiency detergent such as 
Water leaks	Type of detergent	Switch to High Efficiency detergent such as 
	Using too much detergent in washer	Use less detergent. Use less soap if you have soft water, a smaller load or a lightly soiled load.



	Fill hoses or drain hose is improperly connected	Make sure hose connections are tight at faucets and washers are installed. Make sure end of drain hose is inserted in and secured to drain facility.
	Household drain clogged	Check household plumbing. You may need to call a plumber.
	Drain hose rubs on wall	Make sure drain hose does not make contact with the wall. May cause excessive wear on the hose.
	Constant water pressure to fill hoses at water source	Tighten hoses at the faucets. Check condition of the fill hoses; they should be replaced every 5 years.
Water temperature seems incorrect	Cooler water temperatures provide improved energy efficiency	New laundry detergents have been formulated to work with cooler water temperatures without affecting wash performance.
	Water supply is turned off or improperly connected	Turn both hot and cold faucets fully on and make sure hoses are connected to the correct faucets. NOTE: Cold water inlet is blue. Hot water valve inlet is red.
	Water valve screens are stopped up	Turn off the water source and remove the water connection hoses from the upper back of the washer and the water faucets. Clean both the hose screens (if so equipped) and screens in the machine using a brush or a toothpick. Reconnect the hoses and turn the water back on. Check to ensure there are no leaks at the connections.
	Cool/Cold Water when selecting Hot	This is normal. The washer senses water temperature (on some models) and optimizes for best results. Cold water is added periodically when hot is selected.
	House water heater is not set properly	Make sure house water heater is delivering water at 120°F-140°F (48°C-60°C).



<p>Water pumped out before cycle is complete</p>	<p>Water was left in unit for 24 hours with lid closed or 15 minutes with lid open</p>	<p>Previous cycle has been cancelled. Close lid, select cycle, and start machine.</p>
<p>Water won't drain</p>	<p>Drain hose is kinked or improperly connected</p>	<p>Straighten drain hose and make sure washer is not too full. Top of drain outlet should be less than 8 ft (2.44 m).</p>
<p>Washer spins and pauses at the beginning of cycles</p>	<p>This is normal</p>	<p>The washer is sensing the load.</p>



Problem	Possible Causes	What To Do
Washer pauses during wash cycle	The Soak Option was chosen	This is normal. The washer alternates between agitating and soaking during these cycles to get your clothes clean with less wear.
	This is normal	Many cycles incorporate a series of soaks within the cycle period to get your clothes clean with less wear.
Residual powder in dispenser or clogging of dispensers	Wash water too cold or low home water pressure	Select a warmer wash temperature if possible to improve dissolving of detergent or use liquid detergent. Make sure siphon caps are free of debris and fully pressed into dispenser. Remove and clean tray if clogging occurs.
Laundry additives dispensing too soon	Overfilling of dispensers	Do not overfill or add water to dispenser. Select Delay Start option when using fabric softener.
Washer pauses during spin cycle	This is normal	The washer may pause during the spin cycle to remove water more efficiently.
Washer won't operate	Washer is unplugged	Make sure cord is plugged securely into a working outlet.
	Water supply is turned off	Turn both hot and cold faucets fully on.
	Lid is open—safety feature prevents agitation and spinning when lid is up	Close lid and press Start .
	Circuit breaker/fuse is tripped/blown	Check house circuit breakers/fuses. Replace fuses or reset breaker. Washer should have a separate outlet.
	Electronics need to be reset	Unplug washer, wait 2 minutes, plug back in and power washer. If display is active or press Power if unit is in idle (diagnostic) mode.



	Start was not pressed	Press Start .
Detergent packets not dissolving	Laundry detergent packet placed in dispenser	Laundry detergent packets should not be used in the dispensers. They should only be added directly to the detergent basket following the manufacturer's directions.
Unexplained time and/or settings changes	Changing options	This is normal. Several options will change other options to maximize washer performance.
Colored spots	Incorrect use of fabric softener	Check fabric softener package for instructions and directions for using dispenser. Make sure you have selected the Deep Rinse option. Pretreat stain and rewash using Speed Wash cycle and tumble drying.
	Dye transfer	Sort whites or lightly colored items from dark colors.
Grayed or yellowed clothes	Detergent amount	Be sure to follow detergent manufacturer's directions.
	Hard water	Use a water conditioner or install a water softener.
	Water is not hot enough	Make sure water heater is delivering water at 120°F (48°C-60°C).
	Washer is overloaded	Loosely load clothes no higher than the top row of the washer basket. For best results, load items around the perimeter of the basket.
	Dye transfer	Sort clothes by color. If fabric label states wash separately, unstable dyes may be indicated.
Lint or residue on clothes	Clothes are air or line dried	If you do not dry your clothes with a clothes dryer, they may retain more lint.



Incorrect sorting	Separate lint producers from lint collectors.
Washing too long	Wash small loads for a shorter time using Light So
Detergent not dissolving	Rewash, next time: Try a liquid detergent; Use warm temperature.
Overloading	Loosely load clothes in the washer basket. For best load items around the outside of the basket.
Incorrect use of fabric softener	Check fabric softener package for instructions and directions for using dispenser. Make sure you have selected the Deep Rinse option



Problem	Possible Causes	What To Do
Clothes too wet	Incorrect cycle selected	Make sure the cycle selected matches the load you are washing. Some fabrics will feel wetter when rinsed with water.
	Wash load out of balance	Redistribute load in washer and run through Spin cycle.
Blinking Spin light or Spin light on at end of cycle	Out of balance condition has been detected	Allow cycle to continue and finish. If load is wet at the end of the cycle, even out load and run through Spin cycle.
Pilling	Result of normal wear on poly-cotton blends and fuzzy fabrics	While this is not caused by the washer, you can slow down the process by washing garments inside out.
Snags, holes, tears, rips or excessive wear	Pins, snaps, hooks, sharp buttons, belt buckles, zippers and sharp objects left in pockets	Fasten snaps, hooks, buttons and zippers. Remove loose items like pins, objects in pockets and buttons. Turn knits (which snag easily) inside out.
	Undiluted chlorine bleach	Check bleach package instructions for proper amount. Never add undiluted bleach to wash or allow clothes to have direct contact with undiluted bleach.
	Chemicals like hair bleach or dye, permanent wave solution	Rinse items that may have chemicals on them before washing. Use Speed Wash cycle with Extra Rinse option.
Wrinkling	Incorrect wash and dry cycles	Match Cycle selection to the type of fabric you are washing (especially for easy care loads).

	Improper sorting	Avoid mixing heavy items (like jeans) with light items (like blouses). Try a fabric softener.
	Overloading	Loosely load clothes in the washer basket.
	Repeated washing in water that is too hot	Wash in warm or cold water.
Sounds	Possible Causes	Reason
“Clicking”	Shifter mechanism is engaging or disengaging	The drive system will engage at the start of agitation and disengage when agitation is complete. This occurs multiple times during the wash.
Back and forth “swoosh”	Electric motor reversing direction	This sound is the motor rotating back and forth to clean the laundry.
“Clicking” behind Control during fill	Automatic Temperature Control Valve	Two valves mix cold and hot water. The “clicking” is either valve turns on or off to raise or lower the fill water temperature.
Water flow changes during fill	Automatic Temperature Control Valve	Two valves mix cold and hot water. The “clicking” is either valve turns on or off to raise or lower the fill water temperature.
Motor sounds during spin	Motor ramping up/down during spin cycle	The motor will speed up incrementally during the spin cycle. When spin is complete, it will coast until it stops.
“Humming”	Water drain pump	The drain pump will make a humming sound when it pumps out water after agitation stops and continues until spin is complete.
	Drive motor	The drive motor will make a “humming” sound during the wash and spin phases of the cycle.

“Gurgling”	Water drain pump	When the pump starts drawing in air, It starts to gurgle. The washer should then begin spinning and the sound will stop until it is done spinning.
Water “swishing”	Washing process	Water swishing while the unit is agitating is normal, especially with smaller loads.
Washer rocking/ moving and/or “knocking/tapping”	Washer leveling legs uneven	To level the washer, adjust the leveling legs by rotating each individual leg in the proper direction for up or down.
“Squeaking” sound	Washer not level and rubbing on cabinet	To level the washer, adjust the leveling legs by rotating each individual leg in the proper direction for up or down.

Warning

This content is compiled from multiple sources and is provided for reference purposes only. It may not be complete or fully applicable to all situations. If you are unable to resolve your issue, please contact the product manufacturer or an authorized service provider for official support.

