

Washer Safety

IMPORTANT SAFETY INSTRUCTIONS

WARNING: To reduce the risk of fire, electric shock, or injury to persons when using the washer, follow basic precautions, including the following:

- Read all instructions before using the washer.
- Do not wash articles that have been previously cleaned in, washed in, soaked in, or spotted with gasoline, dry-cleaning solvents, other flammable, or explosive substances as they give off vapors that could ignite or explode.
- Do not add gasoline, dry-cleaning solvents, or other flammable, or explosive substances to the wash water. These substances give off vapors that could ignite or explode.
- Under certain conditions, hydrogen gas may be produced in a hot water system that has not been used for 2 weeks or more. **HYDROGEN GAS IS EXPLOSIVE.** If the hot water system has not been used for such a period, before using the washing machine, turn on all hot water faucets and let the water flow from each for several minutes. This will release any accumulated hydrogen gas. As the gas is flammable, do not smoke or use an open flame during
- Do not allow children to play on or in the washer. Close supervision of children is necessary when the washer is used near children.
- Before the washer is removed from service or discarded, remove the door or lid.
- Do not reach into the washer if the drum, tub or agitator is moving.
- Do not install or store the washer where it will be exposed to the weather.
- Do not tamper with controls.
- Do not repair or replace any part of the washer or attempt any servicing unless specifically recommended in this manual or in published user-repair instructions that you understand and have the skills to carry out.
- See “Electrical Requirements” located in the installation instructions for grounding instructions.

Washer Overview

Connectivity Features

Wi-Fi connectivity allows your Smart Washer to connect to the Internet and interact with the Whirlpool™ app from your smartphone or mobile device. This connection opens up several Smart options to you: options intended to save you valuable time and energy

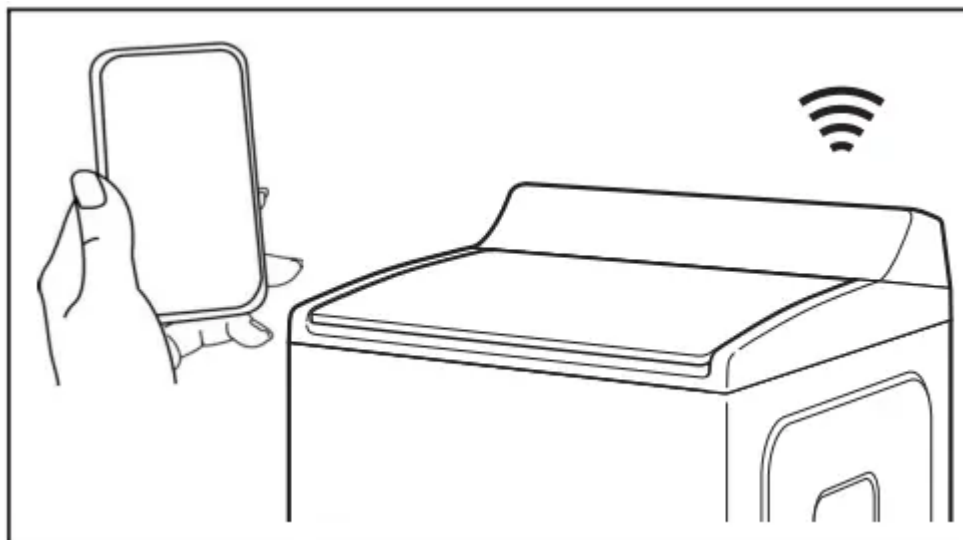

SMART FEATURES

Smart Features help make your every day more efficient by letting you remotely monitor, manage, and maintain your washer

Remote Start & Pause

What it does: Allows you to send the remote control of your washer to your smartphone or mobile device via the Whirlpool™ app.

What it does for you: Lets you manage when to start your wash cycle and when your laundry gets done. Have freshly washed laundry when you're ready for it – not just when you're home to wait.

Cycle Progress

What it does: Gives you an up-to-the-minute look at your wash cycle progress and remaining cycle time from anywhere.

What it does for you: Relieves you of having to visit the laundry room to check on the status of your wash cycle.

Clothes Clean Notification (Opt-In)

What it does: Your washer will send you a push notification when its current cycle is complete.

What it does for you: Alerts you precisely when the wash is done, so you can get the next load started and move on to other things. If you can't unload the washer right away, or are away from home when a cycle finishes, you can remotely activate Load Fresh cycles to help your clothes stay fresh until you're able to get to them.

Specialty Cycles & My Cycle

What it does: Allows you to browse additional wash cycles available in the Whirlpool™ app and download a cycle to the washer with the Download & Go™ option. You can also create and save your own customized cycles.

What it does for you: Takes the guesswork out of selecting the optimal washer settings for garments and household items that require specialized care.

Quiet Mode

What it does: Lets you turn off the tones and beeps coming from your washer.

What it does for you: Allows you to do laundry without disturbing anyone else in the household. **Issue Alerts (Opt-In)** **What it does:** Sends you a push notification if something has gone wrong. **What it does for you:** Gives you a heads-up, and provides guidance to fix simple issues through videos and step-by-step instructions. If the issue is more complex, you can e-mail or call our service center directly from the Whirlpool™ app.

SMART ABOUT ENERGY

Your Smart Washer can monitor and respond to changing energy demand levels on the power grid.

Smart Delay (Opt-In)

What it does: When energy demand is high, it gives you the option to delay starting a wash cycle until demand levels are lower.

What it does for you: You can feel good about giving a little back to the environment. Some consumers may even see a lower energy bill. If you need to begin a wash cycle immediately, you can override a Smart Delay. The washer will return to energy monitoring on the next cycle.

GET STARTED

Refer to the Quick Connect packet that came with your washer, or see the "Connectivity Setup" section on pages 9 and 10 of this Use & Care Guide and follow the instructions to get connected. Check the Whirlpool™ app frequently for additional information and features.

Wash Performance Features

Cleaning with Less Water

Traditional agitator-style washer

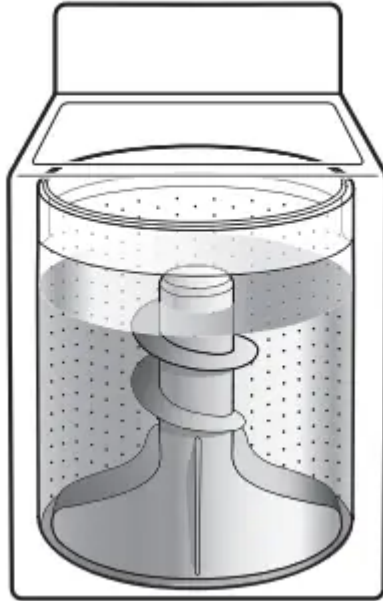

Low-water washer

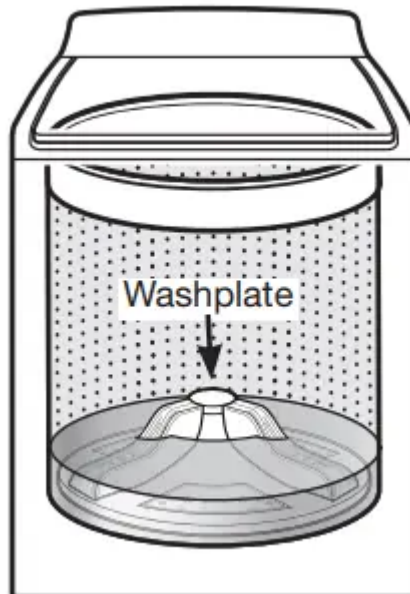

The most visible difference in your new washer is the low-water washplate wash system. The washer automatically adjusts the water level to the load size — no water level selector is needed.



For best performance, it is recommended to load items in loose heaps evenly around the washplate.

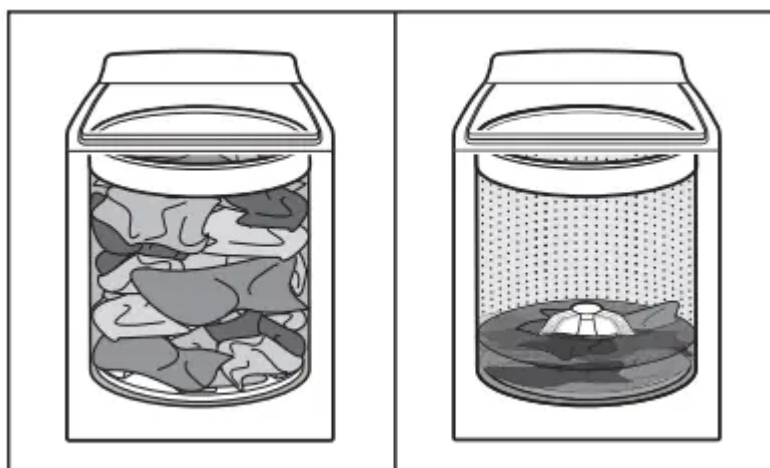

As the washer dampens and moves the load, the level of the items will settle in the basket. This is normal, and does not indicate that more items should be added. **IMPORTANT:** You will not see a washer basket full of water as with your past agitator-style washer. It is normal for some of the load to be above the water line.

Automatic Load Size Sensing

Once you start the cycle, the lid will lock, and the washer will begin the sensing process to determine the correct water level for the load. Initially the basket will start to spin prior to adding water; this is part of the sensing process and is normal. This low-water wash method uses less water and energy compared to a traditional agitator-style washer.

Choosing the Right Detergent

Use only High Efficiency detergents. The package will be marked “HE” or “High Efficiency.” Low-water washing creates excessive sudsing with a regular non-HE detergent. Using regular detergent will likely result in longer cycle times and

reduced rinsing performance. It may also result in component failures and noticeable mold or mildew. HE detergents are made to produce the right amount of suds for the best performance. Follow the manufacturer's instructions to determine the amount of detergent to use and do not go over the Max line. See "Using Laundry Product Dispensers" for more information.



Use only High Efficiency (HE) detergent.

Improved Cleaning

Low-water cleaning means concentrated cleaning. Rather than diluting detergent as done in an agitator-style washer, this washer delivers the detergent directly to the soils. This low water wash also allows the clothing to move in a more effective way to remove soils.

Normal Sounds You Can Expect

At different stages of the wash cycle, you may hear sounds and noises that are different from those of your previous washer. For example, you may hear a clicking and hum at the beginning of the cycle, as the lid lock goes through a self-test. There will be different kinds of humming and whirring sounds as the washplate moves the load and as the basket is slowing down to stop. And sometimes, you may hear nothing at all, as the washer determines the correct water level for your load or allows time for clothes to soak.

Dispensers

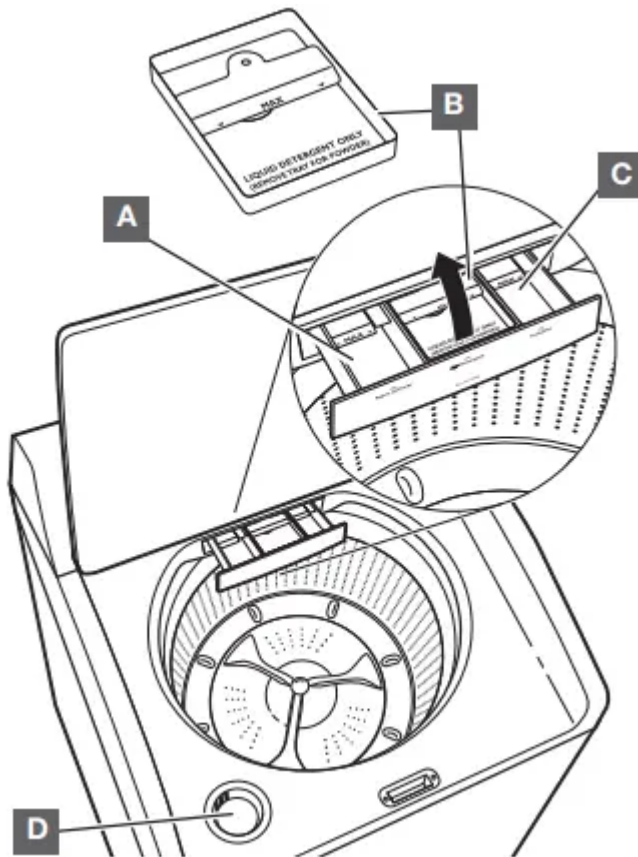

A. Liquid fabric softener dispenser

Pour measured liquid fabric softener into the liquid fabric softener dispenser, if desired. It will dispense automatically at the optimum time.

- Use only liquid fabric softener in this dispenser.

B. High Efficiency “HE” detergent dispenser

Add liquid or powdered HE detergent product to this dispenser for your main wash cycle. Remove tray if using powder detergent.

IMPORTANT: Make sure tray is in drawer when using liquid detergent and removed when using powder detergent and do not go over the Max line.



Use only High Efficiency (HE) detergent.

NOTE: Follow the manufacturer’s instructions to determine the amount of detergent to use.

C. TimedOxi dispenser



This dispenser holds up to 3/4 cup (180 mL) Oxi booster or other laundry booster, such as powdered or liquid color-safe bleach. Laundry boosters are automatically dispensed at the proper time during the wash cycle. Be sure to select Oxi from the Deep Clean options to ensure proper dispensing.

NOTE: Fill dispenser with only Oxi. Do not mix with bleach.

D. Liquid chlorine bleach dispenser

The bleach will be automatically diluted and dispensed at the optimum time during the wash cycle. This dispenser cannot dilute powdered bleach.

NOTE: Fill dispenser with liquid bleach only.

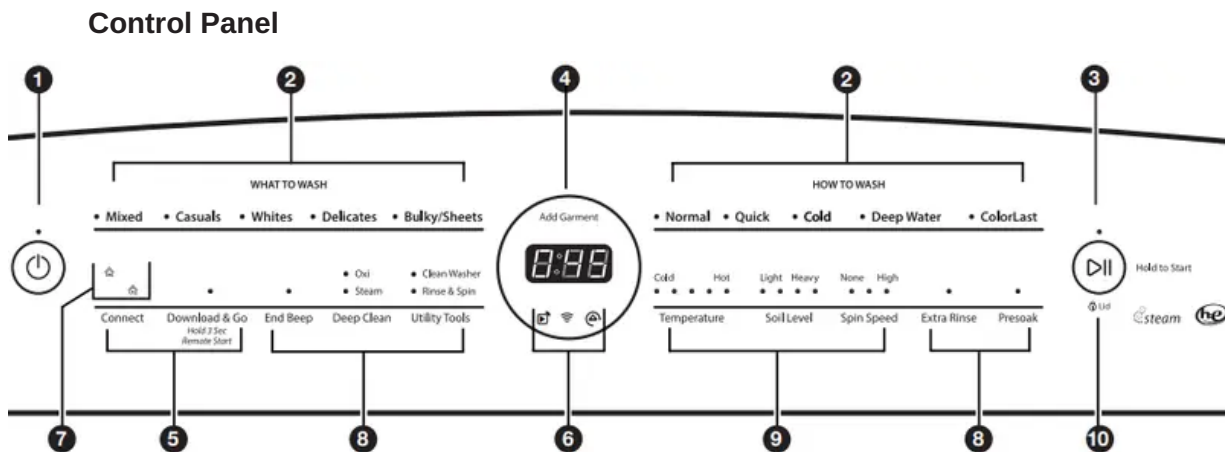

1.POWER BUTTON : Touch to turn the washer ON. Touching once while the washer is on will cancel the current cycle and turn the washer OFF.

2.WHAT TO WASH/HOW TO WASH

First select a setting from the “What to Wash” menu and then select a setting from the “How to Wash” menu to get the best combination cycle available for the type of items you are going to wash. See “Cycle Guide” for cycle details.

3.START/PAUSE BUTTON

Touch and hold the START/PAUSE button to begin the selected cycle; touch again to pause a cycle. The light above the Start/Pause button will be solidly lit in any running states. It turns off at the end of a cycle. It will flash when in a paused state or when waiting for you to touch Start/Pause after setting the washer for Remote Start mode.

4.ADD GARMENT : When Add Garment is lit, you may touch Start/Pause to pause the washer. Open the lid and add items, then touch and hold START/PAUSE to start the washer again. **TIME/STATUS DISPLAY** The Time/Status display shows the time required for the cycle to complete. Factors such as load size and water pressure may affect the time shown in the display. Tightly packed loads, unbalanced loads, or excessive suds may cause the washer to adjust the cycle time as well. When the cycle is complete, the display will show END until the lid is opened.

5.CONNECT BUTTON

Touch CONNECT during the initial connection of the washer to your home Wi-Fi network. The Wi-Fi status indicator (6) will be lit when the washer is connected to the network. See “Connectivity Setup” section for details. If the washer is in a Smart Delay, touch CONNECT to override the delay and begin a wash cycle immediately.

DOWNLOAD & GO™ OPTION : Set a Specialty Cycle or My Cycle in the Whirlpool™ app and download it to your washer. The light above Download & Go™ will illuminate, indicating that the cycle has been received. Touch DOWNLOAD & GO to select the cycle for use. See “Using Your Washer — Smart Operation” for details.

REMOTE START : To start a washer cycle remotely from the Whirlpool™ app, touch and hold DOWNLOAD & GO for about 3 seconds. The Remote Start status indicator (6) and the indicator above the Start/Pause button (3) will begin blinking. Touch and hold START/PAUSE to set the mode. The indicator above Start/Pause will go out, and the Remote Start indicator will be solidly lit.

NOTE: Any interaction with the washer once a Remote Start has been set will cause the mode to cancel. See “Using Your Washer — Smart Operation” for details.

6.CONNECTIVITY STATUS INDICATORS :



7.SMART GRID STATUS INDICATORS (🏠) :

Blue : The BLUE indicator will be lit during times of OFF-PEAK energy demand. Wash cycles will begin without delay upon touch and hold of the Start/Pause button.

Amber : The AMBER indicator will be lit during times of PEAK energy demand. The washer will go into Smart Delay mode upon touch and hold of the Start/Pause button, and the Smart Delay indicator (6) will illuminate. When energy demand returns to OFF-PEAK levels, the AMBER indicator and Smart Delay indicator will go out, the BLUE indicator will illuminate, and the wash cycle will begin. If Whirlpool™ app service is momentarily unavailable, the Smart Grid status indicators will be OFF. Touching Connect will cause the BLUE indicator to blink for 2 seconds and then stay OFF.

8.OPTIONS : You may add or remove options for each cycle. Not all options can be used with all cycles, and some are preset to work with certain cycles.

END BEEP

Touch this button to turn the signal indicating the end of a wash cycle to low, medium, high, or off.

NOTE: You may also adjust the tones that sound when a feature, setting, or option is touched. Touch and hold END BEEP for about 3 seconds to turn key activation sounds to low, medium, high, or off.

DEEP CLEAN

Oxi

Select the Oxi option so that it is added to the load at the correct time.

Steam

The Steam Clean option adds additional soak and wash time to many cycles to help remove tough stains, as well as a steam boost for added cleaning power. Steam Clean uses a heater within the washer to maintain the selected temperature setting throughout the wash period. Steam Clean may be selected as an option with other cycles.

UTILITY TOOLS

Clean Washer

Use this every 30 washes to keep the inside of your washer fresh and clean. This cycle uses a higher water level. Use with affresh® Washer Cleaner tablet or liquid chlorine bleach to thoroughly clean the inside of your washer. This cycle should not be interrupted. See "Washer Care."

IMPORTANT: Do not place garments or other items in the washer during the Clean Washer cycle. Use this cycle with an empty wash tub.

Rinse & Spin

Combines a rinse and high speed spin for loads requiring an additional rinse cycle. Also use for loads that require rinsing only. If you want a Drain & Spin, select RINSE & SPIN and then deselect EXTRA RINSE.

EXTRA RINSE

This option can be used to automatically add a second rinse to most cycles.

PRESOAK

Use this option to add an extra soak period to any cycle to help loosen tough stains. The washer will fill and then pause to soak, and then begin the selected cycle.

9.CYCLE MODIFIERS

When you select a cycle, its default settings or the previous cycle selection will light up

TEMPERATURE

Temperature control senses and maintains uniform water temperatures by regulating incoming hot and cold water. Select a wash temperature based on the type of fabric and soils being washed. For best results and following the garment label instructions, use the warmest wash water safe for your fabric.

- On some cycles, warm and hot water may be cooler than what your previous washer provided.
- Even for cold wash settings, some warm water may be added to the washer to maintain a minimum temperature.

SOIL LEVEL

Soil Level (wash time) is preset for each wash cycle. As you touch the Soil Level pad, the cycle time (minutes) will increase or decrease in the Time/Status display and a different wash time will appear. Select the most suitable setting for your load. For heavily soiled items, select Heavy Soil Level for more wash time. For lightly soiled items, select Light Soil Level for less wash time. Lighter soil level setting will help reduce tangling and wrinkling.

SPIN SPEED

This washer automatically selects the spin speed based on the cycle selected. The preset speeds can be changed. Not all spin speeds are available with all cycles.

- Faster spin speeds mean shorter dry times, but may increase wrinkling in your load.
- Slower spin speeds mean less wrinkling, but will leave your load more damp.

10.LID

The Lid Lock indicator  Lid) lights up when the lid is locked and cannot be opened. If you need to open the lid, touch START/PAUSE. The lid will unlock once the washer movement has stopped. This may take several minutes if the load was spinning at high speed. It will be flashing during any unlocking process. Touch and hold START/PAUSE again to restart the cycle.



Connectivity Setup

IMPORTANT: Proper installation of your washer prior to use is your responsibility. Be sure to read and follow the Installation Instructions that came with your washer.

Automatic Setup Instructions – Wi-Fi Protected Setup (WPS)

You will need:

- A home wireless router capable of Wi-Fi Protected Setup (WPS). The router should be on and have a live Internet connection.
- The Smart Appliance ID (SAID) from your washer. This is located on a sticker under the washer lid.

1. Router setup

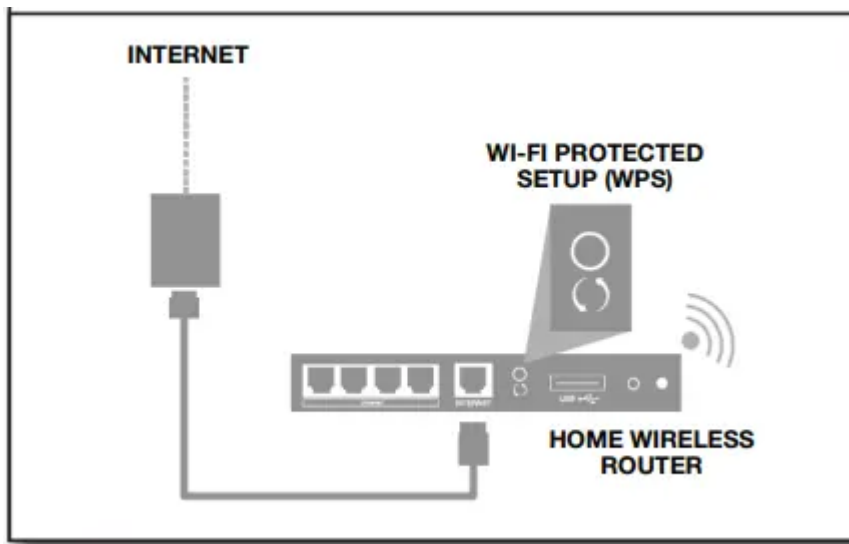

Press the WPS button on the router. An indicator light will begin blinking.

HELPFUL TIP: The WPS function on your router is active for 2 minutes. Complete the next step within that timeframe or you will need to reinitiate WPS.

2. Washer setup (time sensitive step)

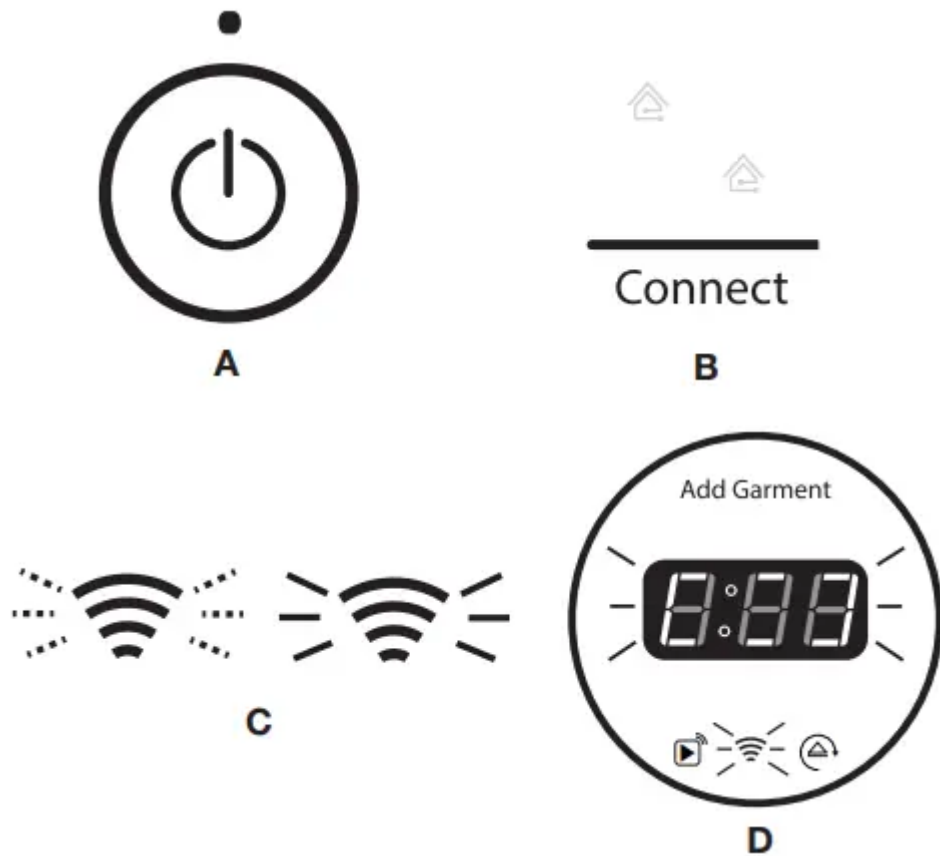
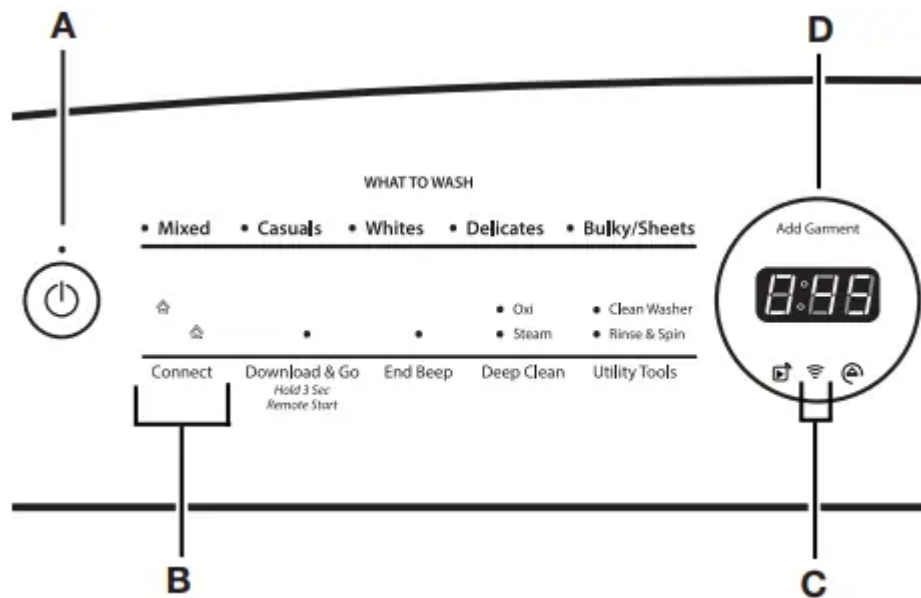

Touch the POWER button (A) to turn on the washer, then touch the CONNECT button (B). The Wi-Fi status indicator (C) on the washer control panel will blink slowly while your washer and router attempt to connect. The Time/Status display (D) will show a “sensing animation”. This can take up to 2 minutes. If the connection is successful, the Wi-Fi status indicator will come on and remain lit.

If Your Washer Doesn't Connect



If your washer and router fail to connect after 2 minutes, the Wi-Fi status indicator (C) will blink rapidly for 2 seconds and then turn off. Refer to the “Troubleshooting — Connectivity” section of this Use & Care Guide, check any connection instructions for your specific router, and refer to alternate instructions at web.

3. Download app



4. Account setup

Once installed, tap the Whirlpool™ app icon to run the app. You will be guided through the steps to set up a user account. The app will make sure to get the necessary personal and home information, as well as information about your energy company

Register your washer in your user account

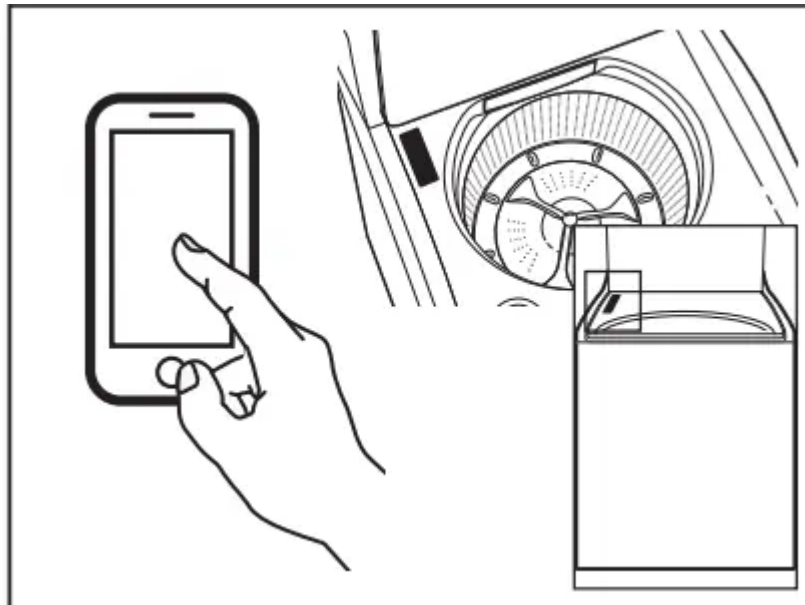

Registering your washer in your account is a necessary step in order for you to take full advantage of the Smart Features. When prompted by the app, enter the Smart Appliance Identification Number (SAID) (case sensitive), which can be found on a sticker under the washer lid.

Cycle Guide

The Whirlpool® Cabrio® washer has a unique user interface to help you select the best cycle you need for your load. The “What to Wash” “How to Wash” layout guides you to the optimal cycle in two easy steps: First determine what items are in the load that you are trying to wash. Use that to guide your “What to Wash” selection. Then determine how you want the washer to wash them and select the appropriate “How to Wash” selection. See chart below for more details. See “Washer Overview — Connectivity Features” and “Using Your Washer — Smart Operation” to learn about downloading and using additional wash cycles from your Whirlpool™ app.

For best fabric care, choose the cycle that best fits the load being washed.

R - Recommended Cycle

a - Alternate Cycle Blank – Cycle is available but not optimal.

		How do you want to wash?				
		“How to Wash” Cycle Selection				
		Normal	Quick	Cold	Deep Water	ColorLast
		• Powerful Soil Removal • Regular	• Fast	• Saving Water & Energy • Cold Wash	• with Extra Water • “Conventional Style” More Water	• Protecting my colors • Protecting my fabrics • Gentle cleaning
What do you want to wash?	“What to Wash” Cycle Selection					
Athletic/High Performance Wear	Mixed	R	a	a	a	a
Bright Colors				a		R
Cottons/Linens		R				
Dark Colors				a		R
Jeans		R	a	a	a	
Pajamas		R	a	a	a	a
Sweatshirts		R	a	a	a	a
Terry Cloth		R	a		a	
Towels		R	a		a	
T-Shirts		R	a	a	a	a
Business Casual	Casuals	R	a	a	a	a
Dress Shirts/Pants		R	a	a	a	a
Linens		R	a	a	a	a
No-Iron Fabrics		R	a	a	a	a



Baby Clothes	Whites	R			a	NA
Dish Cloths		R	a		a	
Handkerchiefs		R	a		a	
Napkins		R	a		a	
Socks		R	a		a	
Tablecloth		R	a	a	a	
Undergarments		R	a		a	
White Clothing		R	a	a	a	
White Shirts		R	a	a	a	
White Towels		R	a		a	
White T-Shirts		R	a	a	a	
Bras	Delicates	R	a	a	a	a
Handwash Fabrics		R	a	a	a	a
Lingerie		R	a	a	a	a
Machine Wash Silks		R	a	a	a	a
Wool		R	a	a	a	a
Blankets	Bulky/Sheets	a	a	a	R	
Coats & Jackets		R	a	a	a	a
Comforters		a	a	a	R	
Machine Wash Curtains		R	a	a	a	a
Machine Wash Slip Covers		R	a	a	a	
Non-Rubber Lined Rugs & Mats		R	a	a	a	
Sheets		R	a		a	a
Sleeping Bags		a	a	a	R	

Using Your Washer

Basic Operation

1. Sort and prepare your laundry

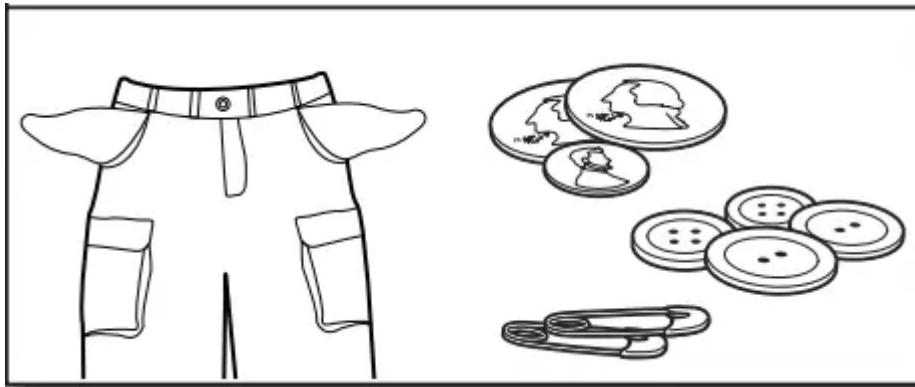

- Empty pockets. Loose change, buttons, or any small object can pass under the washplate and become trapped, causing unexpected sounds.
- Sort items by recommended cycle, water temperature, and colorfastness.
- Separate heavily soiled items from lightly soiled.
- Separate delicate items from sturdy fabrics.
- Do not dry items if stains remain after washing; heat can set stains into fabric.
- Treat stains promptly.

- Close zippers, fasten hooks, tie strings and sashes. Remove non-washable trim and ornaments.
- Mend rips and tears to avoid further damage to items during washing.

Helpful Tips:

- For best performance, use HE liquid detergent when washing bulky items.
- When washing water-proof or water-resistant items, load evenly.
- Use mesh bags to help avoid tangling when washing delicate or small items.
- Turn knits inside out to avoid pilling. Separate lint-takers from lint-givers. Synthetics, knits, and corduroy fabrics will pick up lint from towels, rugs, and chenille fabrics.

NOTE: Always read and follow fabric care label instructions to avoid damage to your items.

2. Add laundry products

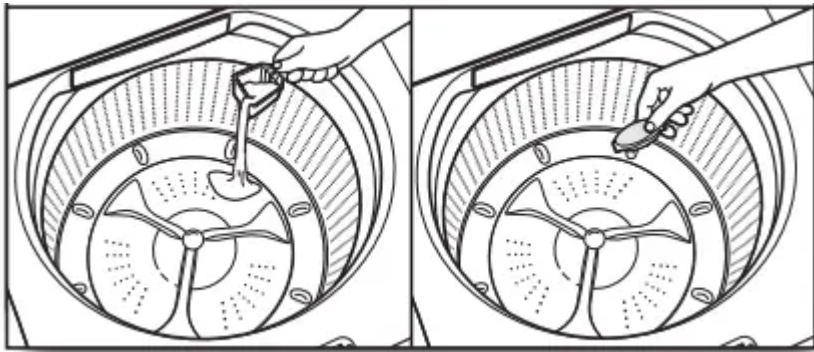

Single-dose laundry packet, color-safe bleach, or fabric softener crystals can be added to the basket prior to adding laundry.

3. Load laundry into washer



For best performance, load items in loose heaps evenly around the washplate. Try mixing different sized items to reduce tangling.

Using Laundry Product Dispensers

4. Add HE detergent

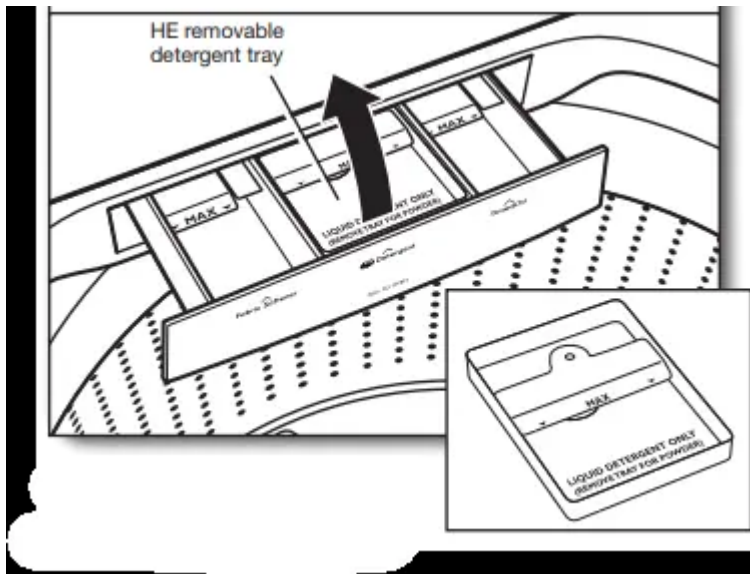

Add a measured amount of HE detergent into detergent tray. This tray holds 3 oz. (89 mL). If adding powder HE detergent, remove inside tray. Do not overfill tray – adding too much detergent may cause detergent to be dispensed into the washer too early and affect performance.

5. Add liquid chlorine bleach to dispenser

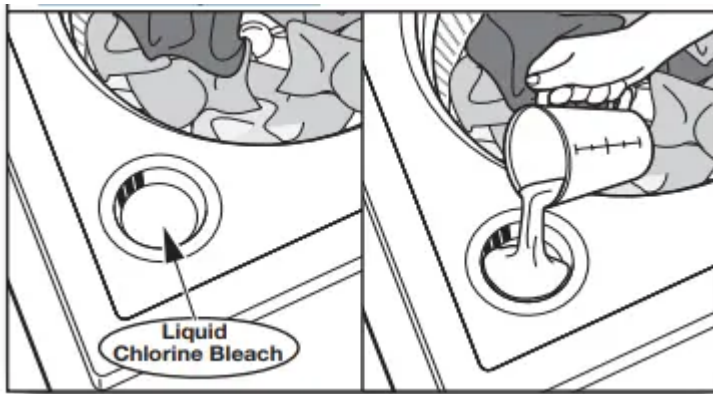

Do not overfill, dilute, or use more than 1 cup (236 mL). Do not use color-safe bleach or Oxi products in the same cycle with liquid chlorine bleach.

6. Add liquid fabric softener or Oxi to dispenser

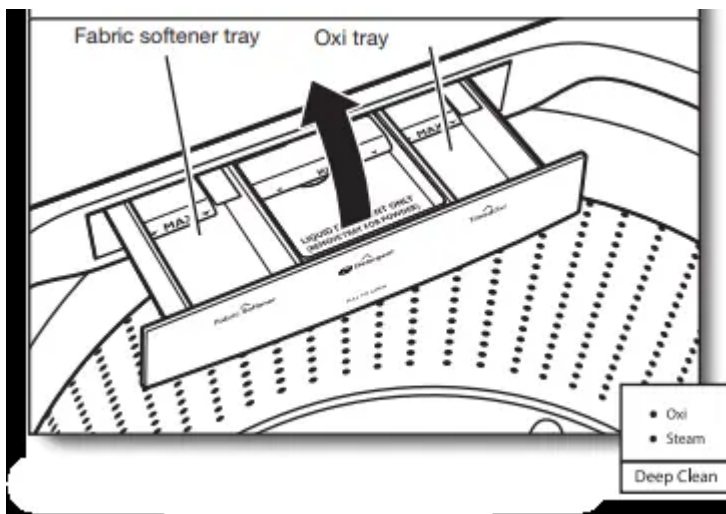

Pour a measured amount of liquid fabric softener or Oxi-type boosters into tray; always follow manufacturer's directions for correct amount of fabric softener or Oxi based on your load size. Close dispenser drawer, then select Oxi option. Oxi is added during main wash and Fabric Softener is added during rinse.

7. Touch POWER to turn on washer

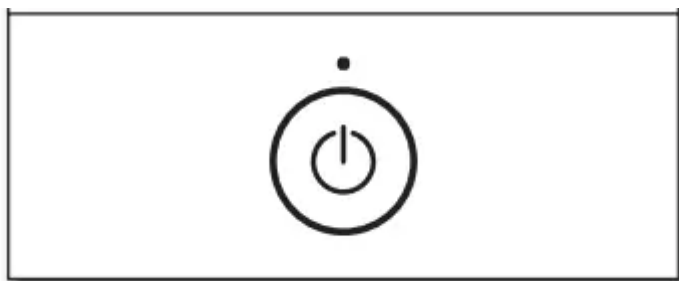

Make sure the dispenser drawer is closed completely, then touch POWER to turn on the washer.

8. Select type of load to wash

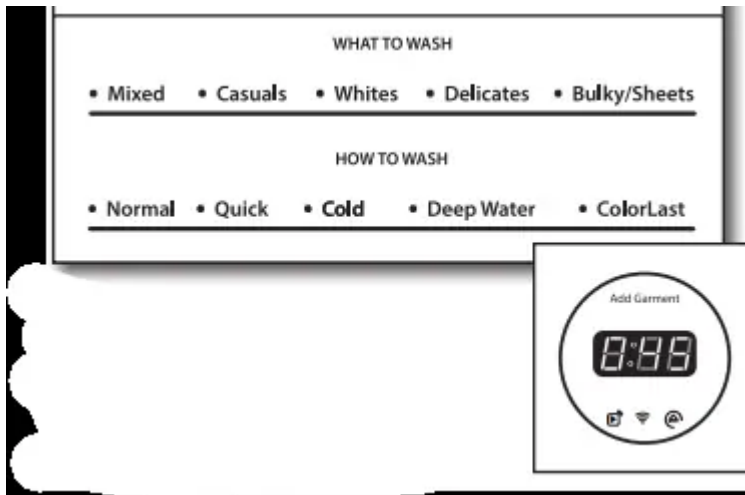

First select and touch a setting from the “What to Wash” menu and then select a setting from the “How to Wash” menu to get the best combination cycle available for the type of items you are going to wash. See “Cycle Guide” for cycle details. Not all settings are available on all cycles. The Time/Status display will light up with a cycle time. You may notice time adjusting during the cycle. This is normal.

9. Select cycle modifiers

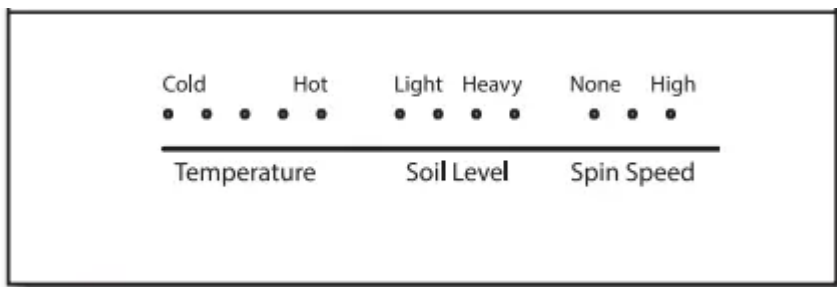

Once you select a cycle, the default modifiers or the previously set modifiers for that cycle will be lit. Touch the cycle settings buttons to change the Soil Level, Spin Speed, and Temperature, if desired. Not all settings are available with all cycles. NOTE: Always read and follow fabric care label instructions to avoid damage to your items. If not sure which temperature to use, refer to the chart below or select a cooler temperature.

Temperature suggestions

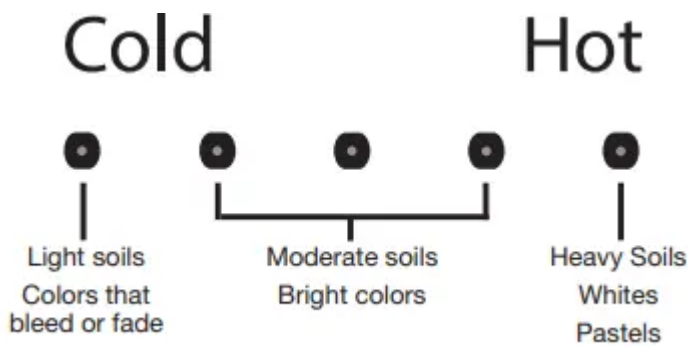

10. Select cycle options

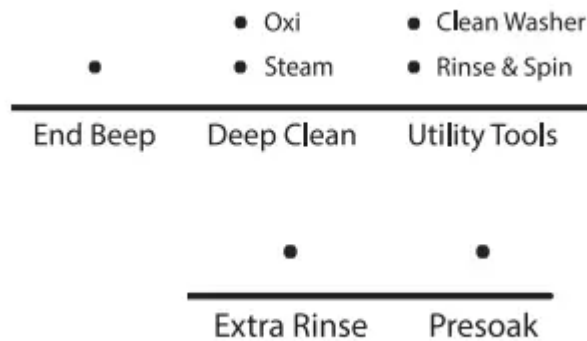

Select any other cycle options you may wish to add, if not previously set. Some cycles will automatically add certain options such as Extra Rinse. These may be turned off, if desired.

11. Touch and hold START/PAUSE button to begin cycle

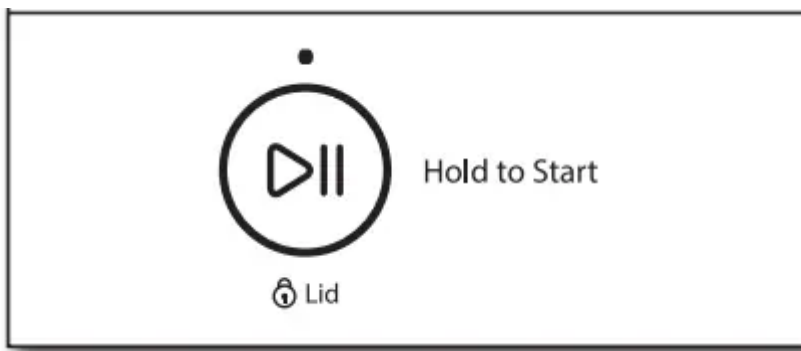

Touch and hold the START/PAUSE button for 3 seconds to start the wash cycle. When the cycle has finished, the end beep will sound (if set). The Whirlpool™ app will send a “Clothes Clean Notification” (if set). See “Using Your Washer — Smart Operation”.

Unlocking the lid to add items

If you need to open the lid to add 1 or 2 missed items: Touch the START/PAUSE button to pause the washer; the lid will unlock once the washer movement has



stopped. This may take several minutes if the load was spinning at high speed. Then close the lid and touch and hold the START/ PAUSE button again to restart the cycle.

12. Remove garments promptly after cycle is finished

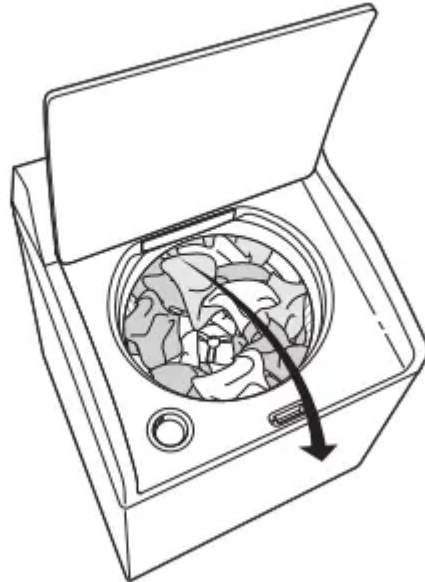

Promptly remove items when cycle is done to avoid odor, reduce wrinkling, and avoid rusting of metal hooks, zippers, and snaps. If you will be unable to remove the load promptly, you may remotely activate the Load Fresh option from the Whirlpool™ app. See “Using Your Washer — Smart Operation” on page 16.

Smart Operation

Download a Specialty Cycle or My Cycle

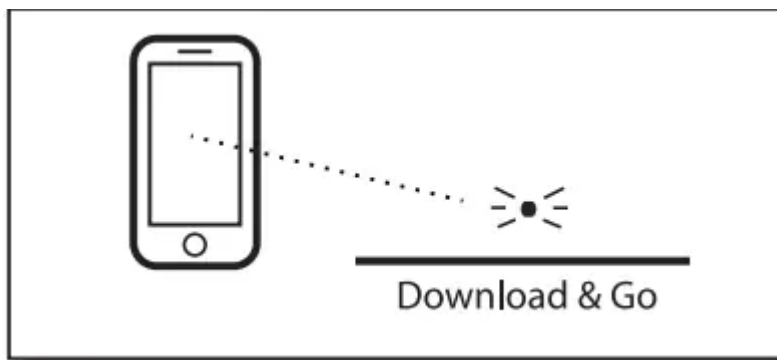

The Download & Go™ option lets you select and send a Specialty Cycle or My Cycle from the Whirlpool™ app directly to your washer. The indicator above Download & Go will illuminate. Touch DOWNLOAD & GO to select the cycle. The Time/Status display will show the estimated cycle time. Touch and hold the START/PAUSE button for 3 seconds as in Step 11 to start the wash cycle, or continue to set the washer for Remote Start.

HELPFUL TIP: The cycle will be remembered for future use until a different cycle is downloaded to the washer.

Set a Remote Start

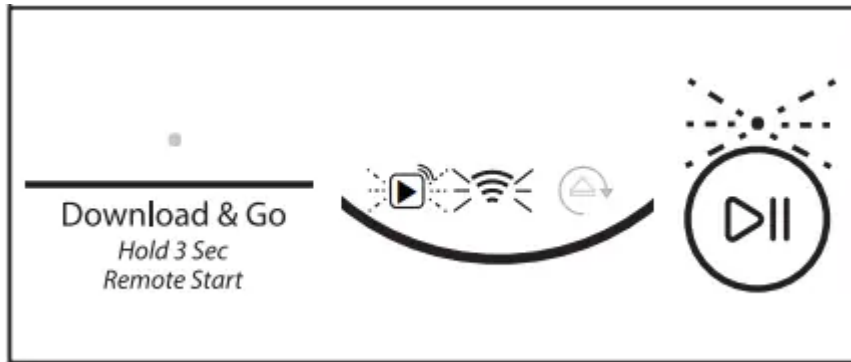

Remote Start mode allows you to start your washer remotely from the Whirlpool™ app. After preparing your laundry load and selecting your cycle settings, touch and hold the DOWNLOAD & GO button for 3 seconds. The

Remote Start status indicator  and the indicator above the Start/Pause button will begin blinking. Touch and hold START/PAUSE to set the mode. The indicator above Start/Pause will go out, and the Remote Start indicator will be solidly lit. When a Remote Start command is received from the app, the washer will start the cycle, causing the indicator above Start/Pause to be lit (indicating running state). The Remote Start indicator will remain lit.

HELPFUL TIP: Make sure that your washer remains closed and the cycle is not adjusted until you start the cycle. Any interaction with the washer itself after a Remote Start has been set will cancel the Remote Start. If the washer needs to be paused to add garments, the Remote Start will need to be reinitiated.

Washer Maintenance

WATER INLET HOSES

Replace inlet hoses after 5 years of use to reduce the risk of hose failure. Periodically inspect and replace inlet hoses if bulges, kinks, cuts, wear, or leaks are found. When replacing your inlet hoses, mark the date of replacement on the label with a permanent marker.

NOTE: This washer does not include inlet hoses. See the Installation Instructions for more information.

WASHER CARE

Recommendations to Help Keep Your Washer Clean and Performing at its Best

1. Always use High Efficiency (HE) detergents and follow the HE detergent manufacturer's instructions regarding the amount of HE detergent to use. Never use more than the recommended amount because that may increase the rate at which detergent and soil residue accumulate inside your washer, which in turn may result in undesirable odor.
2. Use warm and hot wash water settings sometimes (not exclusively cold water washes), because they do a better job of controlling the rate at which soils and detergent accumulate.
3. Always leave the washer lid open between uses to help dry out the washer and prevent the buildup of odor-causing residue.

Cleaning Your Top Loading Washer

Read these instructions completely before beginning the routine cleaning processes recommended below. This Washer Maintenance Procedure should be performed, at a minimum, once per month or every 30 wash cycles, whichever occurs sooner, to control the rate at which soils and detergent may otherwise accumulate in your washer.

Cleaning the Inside of the Washer

To keep your washer odor-free, follow the usage instructions provided above, and use this recommended monthly cleaning procedure:

Clean Washer Cycle

This washer has a special cycle that uses higher water volumes in combination with affresh® Washer Cleaner or liquid chlorine bleach to clean the inside of the washer.

Begin procedure

1. affresh® Washer Cleaner Cycle Procedure (Recommended for Best Performance):
 - a. Open the washer lid and remove any clothing or items.
 - b. Place an affresh® Washer Cleaner tablet in the bottom of the washer basket.
 - c. Do not place an affresh® Washer Cleaner tablet in the detergent dispenser.
 - d. Do not add any detergent or other chemical to the washer when following this procedure.
 - e. Close the washer lid.
 - f. Select the CLEAN WASHER cycle.

g. Touch and hold the START/PAUSE button to begin the cycle. The Clean Washer Cycle Operation is described below

2. Chlorine Bleach Procedure (Alternative):

a. Open the washer lid and remove any clothing or items.

b. Add 1 cup (236 mL) of liquid chlorine bleach to the bleach compartment. NOTE: Use of more liquid chlorine bleach than is recommended above could cause washer damage over time.

c. Close the washer lid.

d. Do not add any detergent or other chemical to the washer when following this procedure.

e. Select the CLEAN WASHER cycle.

f. Touch and hold the START/PAUSE button to begin the cycle. The Clean Washer Cycle Operation is described below.

Description of Clean Washer Cycle Operation:

1. This cycle will fill to a water level higher than in normal wash cycles to provide rinsing at a level above the water line for normal wash cycle.

2. During this cycle, there will be some agitation and spinning to increase the removal of soils. After this cycle is complete, leave the lid open to allow for better ventilation and drying of the washer interior.

Cleaning the Outside of the Washer

Use a soft, damp cloth or sponge to wipe away any spills. Use only mild soaps or cleaners when cleaning external washer surfaces

NON-USE AND VACATION CARE

If moving, or not using your washer for a period of time, follow these steps:

1. Unplug or disconnect power to washer.
2. Turn off water supply to washer, to avoid flooding due to water pressure surge.

CLEANING YOUR DISPENSER

You may find laundry product residue leftover in your dispenser drawer. To remove residue, follow this recommended cleaning procedure:

1. Pull drawer out until you feel resistance.
2. Push 2 tabs downward, and then continue pulling out.
3. Wash in warm, soapy water, using a mild detergent.



4. Rinse with warm water.
5. Air dry, or dry with a towel.
6. Then replace drawer back into slot. Make sure drawer is properly seated.

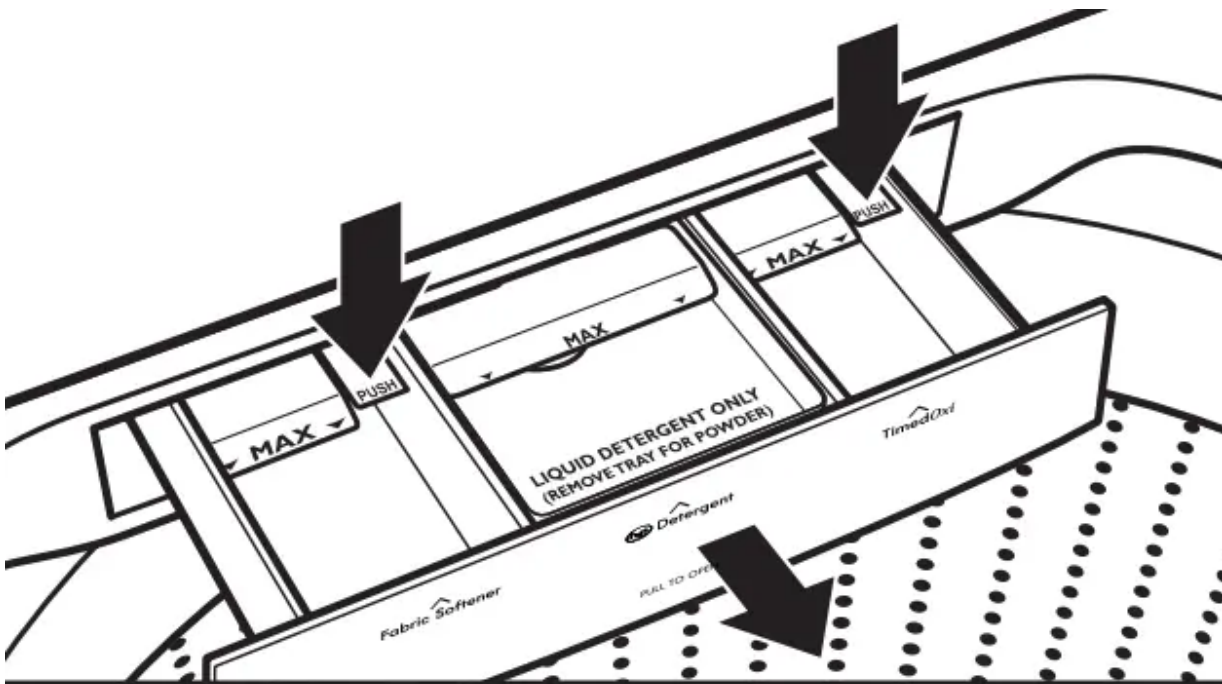

WINTER STORAGE CARE

IMPORTANT: To avoid damage, install and store washer where it will not freeze. Because some water may stay in hoses, freezing can damage washer. If storing or moving during freezing weather, winterize your washer.

To winterize washer:

1. Shut off both water faucets; disconnect and drain water inlet hoses.
2. Put 1 qt. (1 L) of R.V.-type antifreeze in basket and run washer on RINSE & SPIN cycle for about 30 seconds to mix antifreeze and remaining water.
3. Unplug washer or disconnect power.

TRANSPORTING YOUR WASHER

1. Shut off both water faucets. Disconnect and drain water inlet hoses.
2. If washer will be moved during freezing weather, follow WINTER STORAGE CARE directions before moving.
3. Disconnect drain from drain system.
4. Unplug power cord.
5. Place inlet hoses inside washer basket.
6. Drape power cord and drain hose over the console and secure with masking tape.

7. Place foam packing ring from original shipping materials back inside washer. If you do not have packing ring, place heavy blankets or towels into basket opening. Close lid and place tape over lid and down front of washer. Keep lid taped until washer is placed in new location. Transport washer in the upright position.

REINSTALLING/USING WASHER AGAIN

To reinstall washer after non-use, vacation, winter storage, or moving:

1. Refer to Installation Instructions to locate, level, and connect washer.
2. Before using again, run washer through the following recommended procedure:

To use washer again:

1. Flush water pipes and hoses. Reconnect water inlet hoses. Turn on both water faucets.
2. Plug in washer or reconnect power.
3. Run washer through Bulky/Sheets and Deep Water Wash cycle to clean washer and remove antifreeze, if used. Use only HE High Efficiency detergent. Use half the manufacturer's recommended amount for a medium-size load.

Troubleshooting

Connectivity

Connection Status	Control Panel Indicator Lights
Washer is not connected	<ul style="list-style-type: none"> • Wi-Fi icon is OFF • Smart Grid icons are OFF
Washer is attempting to connect to home Wi-Fi router	<ul style="list-style-type: none"> • Wi-Fi icon is blinking slowly
Washer is connected to home Wi-Fi router, but Whirlpool™ app or Smart Grid functions do not work	<ul style="list-style-type: none"> • Wi-Fi icon is ON • Blue Smart Grid icon is blinking slowly
Washer is connected to home Wi-Fi router, and the Whirlpool™ app works	<ul style="list-style-type: none"> • Wi-Fi icon is ON • Smart Grid icon is either ON or OFF — it is not blinking



If you experience	Possible Causes	Solution
Washer is not connected to home Wi-Fi router (Wi-Fi icon is OFF)	The washer may be in standby mode.	Touch the POWER button on the washer and observe indicators. All indicator lights are off when in standby mode.
	The washer has never been connected to the home Wi-Fi router.	See “Connectivity Setup” section.
	The washer has been connected to the home Wi-Fi router, but washer Wi-Fi is OFF.	Press CONNECT. The Wi-Fi icon should blink while connecting (this may take up to 2 minutes).
	Lost connection to home Wi-Fi router	Check whether the router is on and working with other computers or devices in the home (able to access the Internet).
	Weak signal strength or signal interference between the washer and router.	Try to place the wireless router closer to the washer. It may be necessary to install a Wi-Fi range extender.
Wi-Fi icon does not light at all after pressing the Connect button	Something may be wrong with the washer.	Unplug or disconnect washer power for 30 seconds. Return power. Repeat Wi-Fi connect process.
		Verify that the washer operates correctly except for not being able to connect. Call for service.
Washer is connected to home Wi-Fi router, but Whirlpool™ app or Smart Grid functions do not work	Smart Grid features on the washer may be OFF.	Check whether either Smart Grid indicator is on continuously. Touch CONNECT to turn Smart Grid feature on.
	Connection to the Whirlpool™ app and Smart	Check if the blue Smart Grid indicator is blinking.



<p>Grid service may be unavailable.</p>	
<p>User account has not been properly set up, or the washer has not been registered in an account.</p>	<p>See “Connectivity Setup” section or the Whirlpool™ app directly for account setup and washer registration instructions.</p>
	<p>Verify that the washer is paired with your account in the app.</p>
	<p>Verify correct e-mail address, mobile number, and notification preferences.</p>

Washer Operation



If you experience	Possible Causes	Solution
Vibration or Off-Balance		
Vibration, rocking, or “walking”	Feet may not be in contact with the floor and locked.	Front and rear feet must be in firm contact with floor, and washer must be level to operate properly.
	Washer may not be level.	Check floor for flexing or sagging. If flooring is uneven, a 3/4" (19 mm) piece of plywood under your washer will reduce sound
		See “Level the Washer” in the Installation Instructions.
Vibration during spinning or washer stopped	Load could be unbalanced.	Load items in loose heaps evenly around the washplate. Adding wet items to washer or adding more water to basket could unbalance washer.
		Avoid washing single items. Balance a single item such as a rug or jeans jacket with a few extra items. Redistribute the load, close the lid, and touch and hold START/PAUSE.
		Use Bulky/Sheets Deep Water Wash cycle for oversized, nonabsorbent items such as comforters or poly-filled jackets. Other items are not appropriate for Bulky/Sheets Normal cycle. See “Cycle Guide.”
		Item or load not suitable for selected cycle. See “Cycle Guide” and “Using Your Washer.”
Noises		
Clicking or metallic noises	Objects may be caught in washer drain system.	Empty pockets before washing. Loose items such as coins could fall between basket and tub or may block pump. It may be necessary to call for service to remove items.
		It is normal to hear metal items on clothing such as metal snaps, buckles, or zippers touch against the stainless steel basket.

Gurgling or humming	Washer may be draining water	It is normal to hear the pump making a continuous humming sound with periodic gurgling or surging as final amounts of water are removed during the spin/drain cycles.
Humming	Load sensing may be occurring.	You may hear the hum of the sensing spins after you have started the washer. This is normal.
Whirring	Basket may be slowing down.	You may hear the whirring sound of the basket slowing down. This is normal.
Water Leaks		
Check the following for proper installation:	Washer not level.	Water may splash off basket if washer is not level.
	Fill hoses not attached tightly	Tighten fill-hose connection.
	Fill hose washers	Make sure all four fill hose flat washers are properly seated
	Drain hose connection	Pull drain hose from washer cabinet and properly secure it to drainpipe or laundry tub.
		Do not place tape over drain opening.
	Check household plumbing for leaks or clogged sink or drain.	Water can back up out of a clogged sink or drainpipe. Check all household plumbing for leaks (laundry tubs, drain pipe, water pipes, and faucets.)
Washer not loaded as recommended.	An unbalanced load can cause basket to be out of alignment and cause water to splash off tub. See "Using Your Washer" for loading instructions.	
Washer not performing as expected		
Not enough water in washer	Load not completely covered in water.	This is normal operation for an HE low-water washer. The load will not be completely underwater. The washer senses load sizes and adds correct amount of water for optimal cleaning. See "Washer Overview — Wash



		Performance Features”. IMPORTANT: Do not add more water to washer. Adding water lifts the items off the washplate, resulting in less effective cleaning.
		Run clean washer cycle to optimize the water level and wash performance.
Washer not performing as expected		
Washer won't run or fill, washer stops working	Check for proper water supply	Both hoses must be attached and have water flowing to inlet valve.
		Both hot and cold water faucets must be turned on.
		Check that inlet valve screens have not become clogged.
		Check for any kinks in inlet hoses, which can restrict water flow.
	Check proper electrical supply	Plug power cord into a grounded 3-prong outlet
		Do not use an extension cord.
		Ensure there is power to outlet.
		Reset a tripped circuit breaker. Replace any blown fuses. NOTE: If problems continue, contact an electrician.
Normal washer operation.		Lid must be closed for washer to run.
		Washer will pause during certain phases of cycle. Do not interrupt cycle.
		Washer may be stopped to reduce suds.
Washer may be tightly packed.		Remove several items, rearrange load evenly around the washplate. Close lid and touch and hold START/PAUSE button.
		Add only 1 or 2 additional items after washer has started.

		Do not add more water to the washer.
	Not using HE detergent or using too much HE detergent.	Only use HE detergent. Suds from regular detergents can slow or stop the washer. Always measure detergent and following detergent directions based on your load requirements. To remove suds, cancel cycle. Select RINSE & SPIN. Touch and hold START/PAUSE button. Do not add more detergent.
Washer not draining/spinning, loads are still wet	Small items may have been caught in pump or between basket and tub, which can slow draining.	Empty pockets and use garment bags for small items.
	Using cycles with a lower spin speed.	Cycles with lower spin speeds remove less water than cycles with high spin speeds. Use the recommended cycle/spin speed for your item
	Washer may be tightly packed or unbalanced.	Tightly packed loads may not allow the washer to spin correctly, leaving the load wetter than normal. Evenly arrange the wet load for balanced spinning. Select RINSE & SPIN to remove excess water. See "Using Your Washer" for loading recommendations.
	Load off balance.	See "Vibration or Off-Balance" in Troubleshooting section for more information
	Check plumbing for correct drain hose installation. Drain hose extends into standpipe farther than 4.5" (114 mm).	Check drain hose for proper installation. Use drain hose form and securely attach to drainpipe or tub. Do not tape over drain opening. Lower drain hose if the end is higher than 96" (2.4 m) above the floor. Remove any clogs from drain hose.
	Not using HE detergent or using too much HE detergent.	Suds from regular detergent or using too much detergent can slow or stop draining or spinning. Use only HE detergent. Always measure and follow detergent directions for your load. To

		remove extra suds, Select RINSE & SPIN. Do not add detergent.
Incorrect or wrong wash or rinse temperatures	Check for proper water supply.	Make sure hot and cold inlet hoses are not reversed.
Incorrect or wrong wash or rinse temperatures	Check for proper water supply	Both hoses must be attached to both washer and faucet, and have both hot and cold water flowing to inlet valve.
		Check that inlet valve screens are not clogged.
	Remove any kinks in hoses.	
	Check for proper water supply	ENERGY STAR® qualified washers use cooler wash and rinse water temperatures than traditional top-load washers. This includes cooler hot and warm washes.
Load not rinsed	Check for proper water supply.	Make sure hot and cold inlet hoses are not reversed.
		Both hoses must be attached and have water flowing to the inlet valve.
		Both hot and cold water faucets must be on.
		Inlet valve screens on washer may be clogged.
		Remove any kinks in the inlet hose.
	Not using HE detergent or using too much HE detergent.	The suds from regular detergent can cause the washer to operate incorrectly.
		Use only HE detergent. Be sure to measure correctly
		Always measure detergent and follow detergent directions based on load size and soil level.
Washer may be tightly packed	The washer is less efficient at rinsing when load is tightly packed.	
	Load items in loose heaps evenly around the washplate.	

		Use cycle designed for the fabrics being washed
		Add only 1 or 2 additional items after washer has started.
Sand, pet hair, lint, etc. on load after washing	Heavy sand, pet hair, lint, and detergent or bleach residues may require additional rinsing.	Add an Extra Rinse to the selected cycle.
Load is tangling	Washer not loaded as recommended	. Load items in loose heaps evenly around the washplate.
		Reduce tangling by mixing types of load items. Use the recommended cycle for the type of items being washed.
Not cleaning or removing stains	Wash load not completely covered in water.	Washer senses load size and adds correct amount of water. This is normal and necessary for clothes to move.
	Added more water to washer.	Do not add more water to washer. Adding water lifts the items off the washplate, resulting in less effective cleaning.
	Washer not loaded as recommended	Load items in loose heaps evenly around the washplate
		Add only 1 or 2 additional items after washer has started.
	Not using HE detergent or using too much HE detergent.	The suds from regular detergent can prevent washer from operating correctly.
		Use only HE detergent. Be sure to measure correctly
	Always measure detergent and follow detergent directions based on load size and soil level.	
Not using correct cycle for fabric type.		Use a higher soil level cycle option and warmer wash temperature to improve cleaning.

		If using Quick cycle, wash only a few items.
		Use Whites Normal cycle for tough cleaning.
		See the “Cycle Guide” to match your load with the best cycle.
	Not using dispensers.	Use dispensers to avoid chlorine bleach and fabric softener staining.
		Load dispensers before starting a cycle.
		Avoid overfilling.
		Do not add products directly onto load.
	Not washing like colors together.	Wash like colors together and remove promptly after the cycle is complete to avoid dye transfer
Odors	Monthly maintenance not done as recommended.	Run the Clean Washer cycle after every 30 washes. See “Washer Care” in “Washer Maintenance.”
		Unload washer as soon as cycle is complete.
	Not using HE detergent or using too much HE detergent.	Use only HE detergent. Be sure to measure correctly
Always follow the detergent directions.		
See “Washer Care” section.		
Fabric Damage	Sharp items were in pockets during wash cycle.	Empty pockets, zip zippers, and snap or hook fasteners before washing to avoid snags and tears.
	Strings and straps could have tangled.	Tie all strings and straps before starting wash load.
	Items may have been damaged before washing.	Mend rips and broken threads in seams before washing.
	Fabric damage can occur if the load is tightly packed.	Load items in loose heaps evenly around washplate.

		<p>Load items should move freely during wash to avoid damage.</p>
		<p>Use cycle designed for the fabrics being washed.</p>
		<p>Add only 1 or 2 additional items after washer has started.</p>
	<p>Garment care instructions may not have been followed.</p>	<p>Always read and follow garment manufacturer's care label instructions. See the "Cycle Guide" to match your load with the best cycle.</p>
	<p>Liquid chlorine bleach may have been added incorrectly.</p>	<p>Do not pour liquid chlorine bleach directly onto load. Wipe up bleach spills.</p>
		<p>Undiluted bleach will damage fabrics. Do not use more than recommended by manufacturer.</p>
		<p>Do not place load items on top of bleach dispenser when loading and unloading washer.</p>
<p>Incorrect dispenser operation</p>	<p>Incorrect dispenser operation</p>	<p>Do not overfill dispenser. Overfilling causes immediate dispensing</p>
		<p>Load dispensers before starting a cycle.</p>
		<p>It is normal for small amounts of water to be remain in dispenser at the end of the cycle.</p>
		<p>Homes with low water pressure may result in residual powder in the dispenser. To avoid, select a warmer wash temperature if possible, depending on your load.</p>
		<p>Clean dispenser nozzle and make sure drawer is properly seated.</p>
	<p>Liquid chlorine bleach not used in dispenser.</p>	<p>Use only liquid chlorine bleach in the bleach dispenser.</p>
<p>Powdered detergent not dissolving completely in load</p>	<p>Using too much HE detergent.</p>	<p>Follow the manufacturer's instructions to determine the amount of detergent to use.</p>
		<p>Select a warmer wash temperature.</p>



	Water temperature is very cold.	Try adding the detergent to the basket prior to adding laundry, rather than using the detergent dispenser
Single-dose laundry packet not dissolving	Adding laundry packet incorrectly	Be sure laundry packet is added to washer basket before adding clothes. Follow the manufacturer's instructions to avoid damage to your items.
Error Code Appears in Display		
"LF" (F8E1) (too long to fill) appears in display	Washer taking too long to fill. Drain extends more than 4.5" (114 mm) into standpipe.	Check plumbing for correct drain hose installation. Use drain hose form and attach securely to drainpipe or tub. Do not tape over drain opening. See Installation Instructions.
F#E# code (F-type error code) appears in display	System error code.	Touch POWER to clear the code and exit cycle. Then touch POWER, select cycle, and then touch and hold START/PAUSE to start washer. If code appears again, call for service.
F1E1 ACU (Appliance control fault)	Internal ACU failure.	Call for service.
F2E3 UI/ACU mismatch	ACU/UI initialization error.	Call for service.
F3E1 Water level sensing failure	Pressure sensor on ACU failure.	Call for service.
F5E2 Lid lock will not lock/lid lock failure	An item in the load may be keeping the lid from locking.	Check for items directly under the lid.
F5E3 Lid cannot unlock	Objects on washer lid prevent it from unlocking.	Remove objects, such as baskets of laundry, from top of washer
F6E2 or F6E3 Communication Error: UI cannot communicate	ACU or UI synchronization error.	Remove power from the washer. Let washer sit for 5 minutes for the washer to completely power down. Apply power to washer and check for error codes. If the error code persists, call for service.



F8E6 (Lid opened) appears in display	Washer lid left open.	Close the lid and touch POWER to clear the display. If the lid is left open for more than 10 minutes, the cycle will reset and water in the washer will drain.
"drn" "dr" (F9E1) (drain pump system problem – long drain) appears in display	Washer taking too long to drain water. Drain extends more than 4.5" (114 mm) into standpipe.	Check plumbing for correct drain hose installation. Use drain hose form and attach securely to drainpipe or tub. Do not tape over drain opening.
		Lower drain hose if the end is higher than 96" (2.4 m) above the floor. Remove any clogs from drain hose. See Installation Instructions.

Warning

This content is compiled from multiple sources and is provided for reference purposes only. It may not be complete or fully applicable to all situations. If you are unable to resolve your issue, please contact the product manufacturer or an authorized service provider for official support.

