

## Operating Instructions

### About the controls with temperature settings.

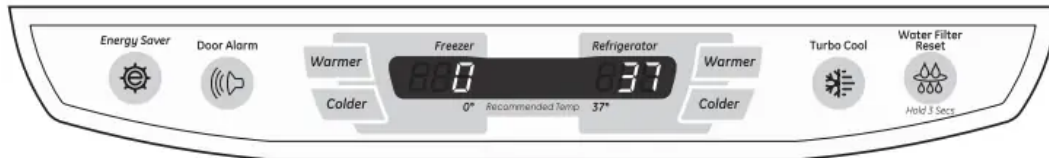

(on some models)

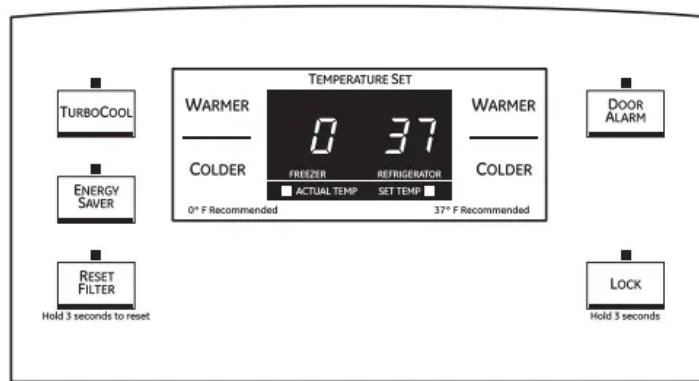

(on some models)

NOTE: The refrigerator is shipped with protective film covering the temperature controls. If this film was not removed during installation, remove it now.

The temperature controls are preset in the factory at 37°F for the refrigerator compartment and 0°F for the freezer compartment. Allow 24 hours for the temperature to stabilize to the preset recommended settings.

The temperature controls can display both the SET temperature as well as the actual temperature in the refrigerator and freezer. The actual temperature may vary slightly from the SET temperature based on usage and operating environment.

Setting either or both controls to OFF stops cooling in both the freezer and refrigerator compartments, but does not shut off electrical power to the refrigerator.

### Changing the Temperature

For Controls-on-the-Door Models:

To change the temperature, press and release the WARMER or COLDER pad. The ACTUAL TEMP light will come on and the display will show the actual temperature. To change the temperature, tap either the WARMER or COLDER pad until the desired temperature is displayed.

For Controls Inside the Refrigerator:

Opening the door displays the actual temperature. To change the temperature, press either the WARMER or COLDER touch pads until the desired temperature is displayed.

Once the desired temperature has been set, the temperature display will return to the actual refrigerator and freezer temperatures after 5 seconds. Several adjustments may be required.

Each time you adjust controls, allow 24 hours for the refrigerator to reach the temperature you have set.

To turn the cooling system off, tap the WARMER pad for either the refrigerator or the freezer until the display shows *OFF*. To turn the unit back on, press the COLDER pad for either the refrigerator or freezer. Then press the COLDER pad again and it will go to the preset points of 0°F for the freezer and 37°F for the refrigerator. Setting either or both controls to *OFF* stops cooling in both the freezer and refrigerator compartments, but does not shut off electrical power to the refrigerator.

### About TurboCool.™ (on some models)

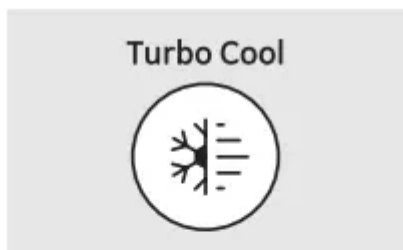

*(on some models)*

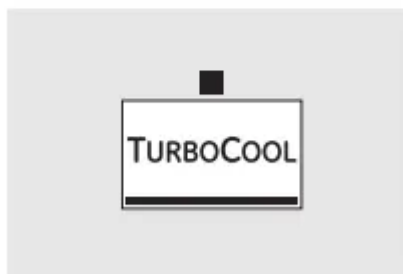

*(on some models)*

### How it Works

*TurboCool* rapidly cools the refrigerator compartment in order to more quickly cool foods. Use *TurboCool* when adding a large amount of food to the refrigerator compartment, putting away foods after they have been sitting out at room temperature or when putting away warm leftovers. It can also be used if the refrigerator has been without power for an extended period.

Once activated, the compressor will turn on immediately and the fans will cycle on and off at high speed as needed for eight hours. The compressor will continue to run until the refrigerator compartment cools to approximately 34°F (1°C), then it will cycle on and off to maintain this



setting. After 8 hours, or if *TurboCool* is pressed again, the refrigerator compartment will return to the original setting.

### How to Use

Press *TurboCool*. The refrigerator temperature display will show t c.

After *TurboCool* is complete, the refrigerator compartment will return to the original setting.

*NOTES:* The refrigerator temperature cannot be changed during *TurboCool*. The freezer temperature is not affected during *TurboCool*. When opening the refrigerator door during *TurboCool*, the fans will continue to run if they have cycled on.



*(on some models)*



*(on some models)*

### About Door Alarm (on some models)

The door alarm will sound if any door is open for more than 2 minutes. The beeping stops when you close the door



*(on some models)*



*(on some models)*

### **About Energy Saver (on some models)**

This product is equipped with an Energy Saver feature. The refrigerator is shipped with the Energy Saver feature enabled. Over time, moisture can form on the front surface of the refrigerator cabinet and cause rust. If moisture does appear on the front surface of the refrigerator cabinet, turn off the Energy Saver feature by pressing and releasing the ENERGY SAVER pad on the control panel

### **About the water filter. (on some models)**

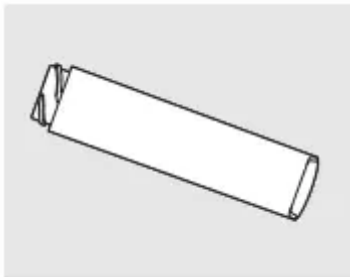

### **Water Filter Cartridge**

The water filter cartridge is located in the back upper right corner of the refrigerator compartment.

### **When to Replace the Filter**

There is a replacement indicator light for the water filter cartridge on the temperature display. This light will turn orange to tell you that you need to replace the filter soon. The filter cartridge should be replaced when the replacement indicator light turns red or if the flow of water to the dispenser or icemaker decreases.

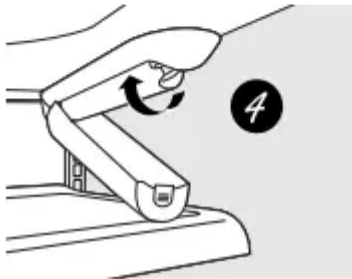
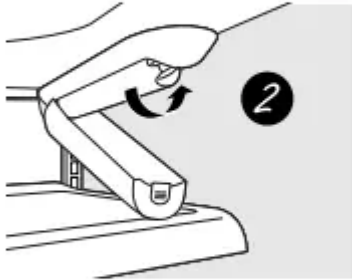
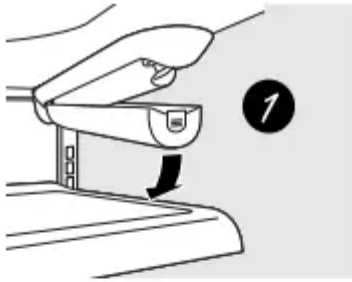

### Installing the Filter Cartridge

1. If you are replacing the cartridge, first remove the old one. Open the cartridge cover by pressing in on the tab at the front and pulling down.
2. Remove the cartridge by slowly rotating it counterclockwise. A small amount of water may drip down.
3. Remove the protective foil from the end of the cartridge.
4. Lining up the arrow on the cartridge and the cartridge holder, slowly rotate the cartridge clockwise until it stops. When the cartridge is properly installed, you will feel it “click” as it locks into place. The grip on the end of the cartridge should be positioned vertically. *Do not overtighten.*
5. Close the cartridge cover.
6. Run water from the dispenser for 3 minutes (about 1 1/2 gallons) to clear the system and prevent sputtering. See *To Use the Dispenser* section.
7. Press and hold the *RESET WATER FILTER* pad for 3 seconds.

*NOTE: A newly-installed water filter cartridge may cause water to spurt from the dispenser.*

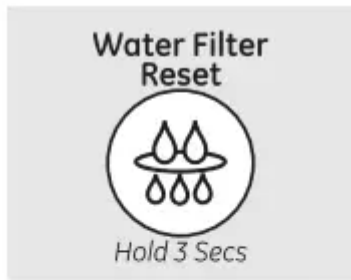

*(on some models)*

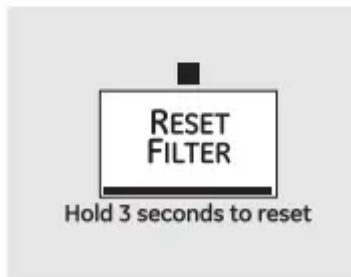

*(on some models)*

### **Filter Bypass Plug**

You must use the filter bypass plug when a replacement filter cartridge is not available. The icemaker will not operate without the filter or filter bypass plug.

### **Replacement Filters:**

To order additional filter cartridges in the United States, visit our Website, [ge.com](http://ge.com), or call GE Parts and Accessories, 800.626.2002.

Filter Model GSWF

Customers in Canada should consult the yellow pages for the nearest Mabe Service Center.

### **About the shelves and bins.**

#### **Rearranging the Shelves**

Shelves in the refrigerator compartment are adjustable.

#### **Refrigerator Compartment**

To remove:

1. Remove all items from the shelf.
2. Tilt the shelf up at the front.
3. Lift the shelf up at the back and bring the shelf out.

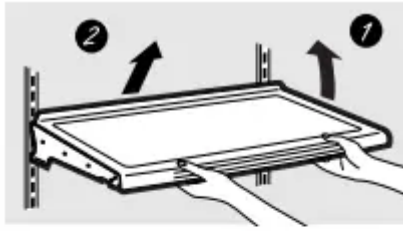

Some models have wire shelves that can be adjusted in the same manner.

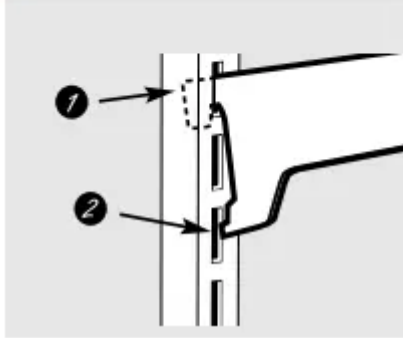

To replace:

1. While tilting the shelf up, insert the top hook at the back of the shelf in a slot on the track.
2. Lower the front of the shelf until the bottom of the shelf locks into place.

### **Spillproof Shelves** (on some models)

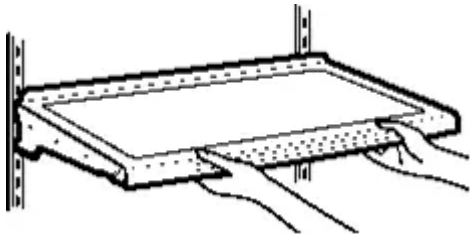

Spillproof shelves have special edges to help prevent spills from dripping to lower shelves. To remove or replace the shelves, see *Rearranging the Shelves*.

### **Slide-Out Spillproof Shelf** (on some models)

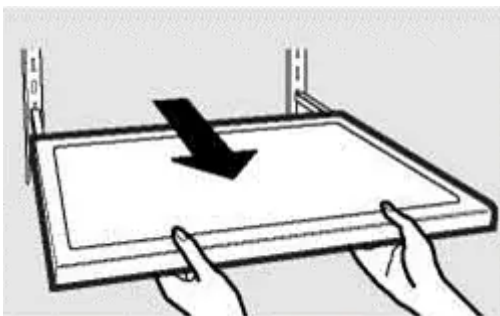

The slide-out spillproof shelf allows you to reach items stored behind others. The special edges are designed to help prevent spills from dripping to lower shelves.

To remove

1. Remove all items from shelf.
2. Slide the shelf out until it stops.
3. Lift the front edge of the shelf until the central tabs are above the front bar.
4. Continue pulling the shelf forward until it can be removed.

To replace:

1. Place the rear shelf tabs just in front of the central notches on the shelf frame.
2. Slide the shelf in until the central tabs are slightly behind the front bar.
3. Lower the shelf into place until it is horizontal and slide the shelf in.

*Make sure that the shelf sits flat after reinstallation and doesn't move freely from side to side.*

*Make sure you push the shelves all the way in before you close the door.*

### **Adjustable Bins on the Door**

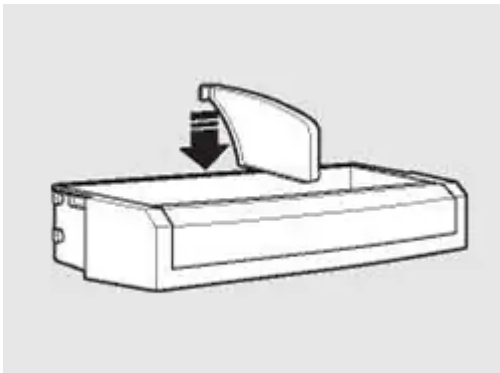

Adjustable bins can easily be carried from refrigerator to work area.

To remove: Lift bin straight up, then pull out.

To replace or relocate: Slide in the bin just above the molded door supports, and push down. The bin will lock in place.

The snugger helps prevent tipping, spilling or sliding of small items stored on the door shelf. Grip the finger hold near the rear of the snugger and move it to fit your needs.

### **Non-Adjustable Bins on the Door**

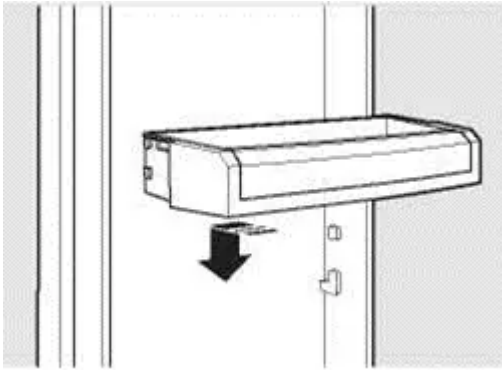

*To remove:* Lift the bin straight up, then pull out.

*To replace:* Engage the bin in the molded supports on the door and push down. It will lock in place.

### **About the additional features.**

*Not all features are on all models.*

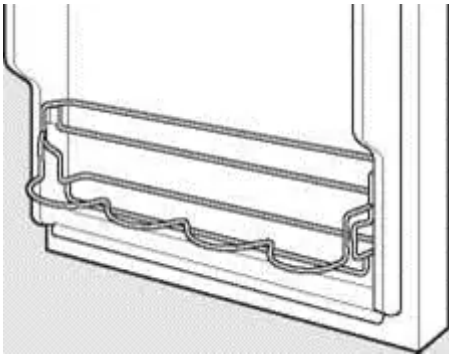

### **Non-Adjustable Beverage Rack**

*To remove:* Lift the rack straight up, then pull out.

*To replace:* Engage the rack in the molded supports on the door and push down.

It will lock in place.

### **About the crispers and pans.**

#### **Fruit and Vegetable Crisper**

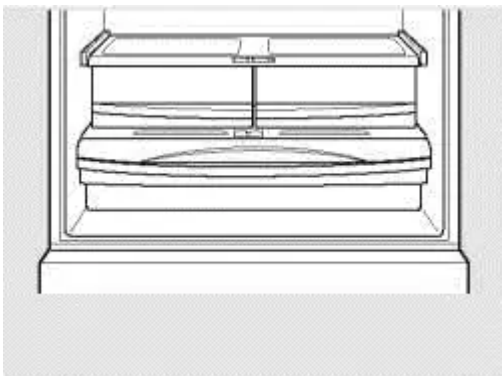

Excess water that may accumulate in the bottom of the drawers or under the drawers should be wiped dry.

### Adjustable Humidity Crisper (on some models)

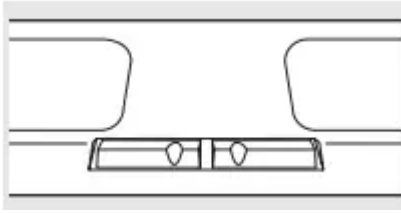

Slide the control all the way to the HIGH setting to provide high humidity recommended for most vegetables. Slide the control all the way to the LOW setting to provide lower humidity levels recommended for most fruits.

### Adjustable Temperature Deli Pan (on some models)

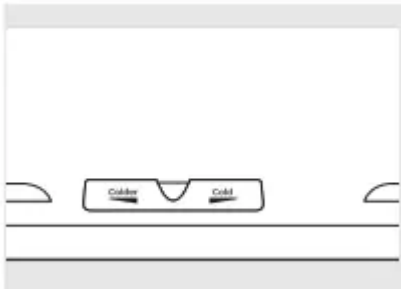

Slide the control all the way to the left for the coldest temperature.

### How to Remove and Replace the Deli Pan

To remove:

1. Remove the fruit and vegetable drawers.
- 2.

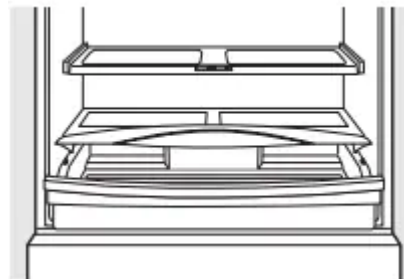

Pull the drawer out to the stop position.

- 3.

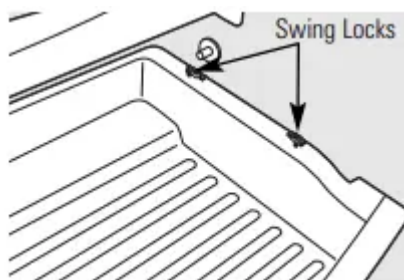

Lift the lid to access the 4 swing locks.

4. Rotate all four swing locks to the unlock position.
5. Lift the front of the drawer up and out.

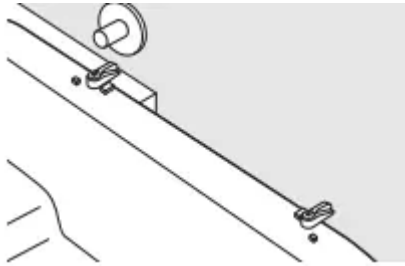

To replace:

1. Make sure all four swing locks are in the unlock position.
2. Place the sides of the drawer into the drawer supports, making sure the swing locks fit on the drawer slots.
3. Lock all four swing locks by rotating them to the lock position.

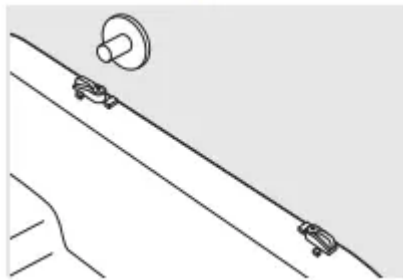

4. Lower the lid and slide in the drawer.
5. Replace the fruit and vegetable drawers.

## About the freezer.

### Freezer Shelves and Baskets

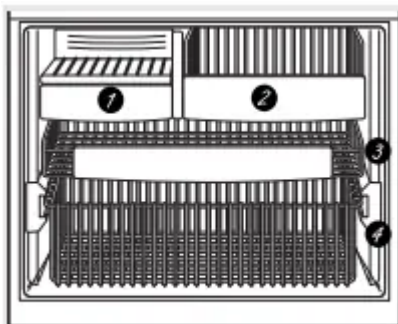

*Appearance and features may vary*

1. A shelf above the ice storage bin
2. A half-width basket
3. A shallow full-width basket

4. A deep full-width basket

### **Basket Removal**

To remove the deep full-width basket on freezer drawer models:

1. Open the freezer drawer until it stops.
2. The freezer basket rests on the inside tabs on the drawer slides.
3. Lift the basket so that all 4 tabs are out of the slide bracket.
4. Tilt the basket and lift out of the drawer.
5. Make sure the plastic sleeves remain attached to the 4 tabs on the slide brackets.

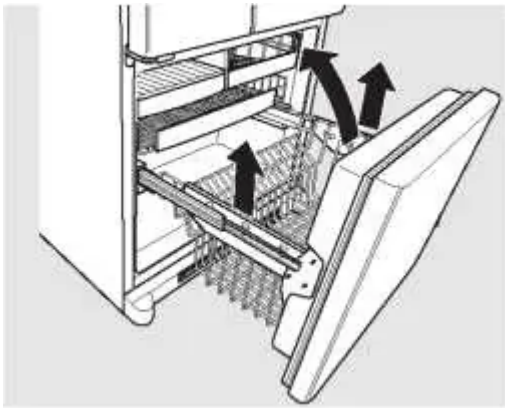

*Appearance may vary*

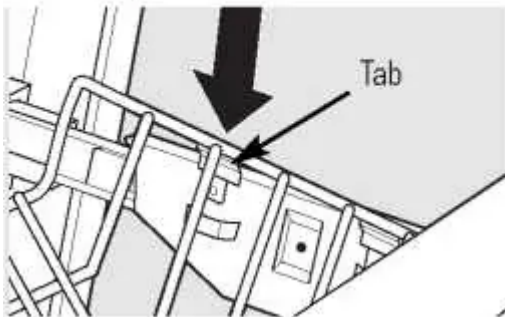

When replacing the deep full-width basket:

Tilt the basket back and lower it down into the drawer. Rotate the basket to a horizontal position and press it down into the 4 alignment tabs.

**NOTE:** Always be sure that all 4 basket tabs are engaged in the slide brackets before sliding back into the freezer.

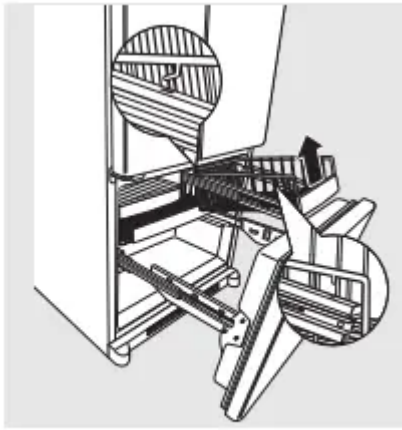

*Appearance may vary*

To remove the half-width basket:

1. Pull the basket out to the stop location.
2. Lift the basket up at the front to release it from the slides.
3. Lift the back up and out of the slide.

When replacing the basket, make sure that the wire tabs and wire hooks on the sides of the basket go into the slots in the top of the upper basket slides.

NOTE: Always be sure to fully close this basket.

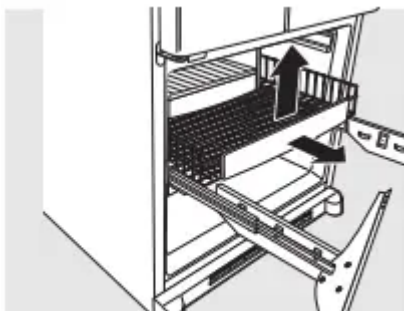

*Appearance may vary*

To remove the shallow full-width basket:

1. Pull the basket out to the stop location.
2. Lift the front up and over the stop location.
3. Lift the basket up and out

### **About the automatic icemaker.**

A newly installed refrigerator may take 12 to 24 hours to begin making ice.

### **Automatic Icemaker (on some models)**

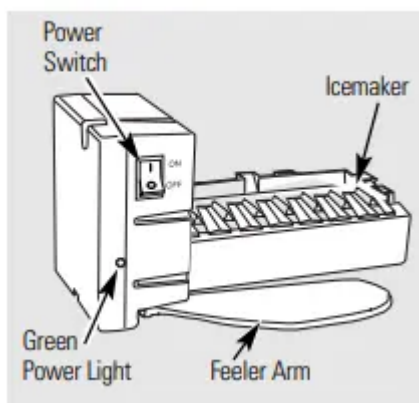

The icemaker will produce seven cubes per cycle—approximately 100-130 cubes in a 24-hour period, depending on freezer compartment temperature, room temperature, number of door openings and other use conditions.

See below for how to access ice and reach the power switch.

If the refrigerator is operated before the water connection is made to the icemaker, set the power switch in the O (off) position.

When the refrigerator has been connected to the water supply, set the power switch to the I (on) position. The icemaker power light will turn green when the freezer light switch is pressed in or when the freezer door is closed.

The icemaker will fill with water when it cools to 15°F (–10°C). A newly installed refrigerator may take 12 to 24 hours to begin making ice cubes.

You will hear a buzzing sound each time the icemaker fills with water.

Throw away the first few batches of ice to allow the water line to clear.

Be sure nothing interferes with the sweep of the feeler arm.

When the bin fills to the level of the feeler arm, the icemaker will stop producing ice. It is normal for several cubes to be joined together.

If ice is not used frequently, old ice cubes will become cloudy, taste stale and shrink.

NOTE: In homes with lower-than-average water pressure, you may hear the icemaker cycle multiple times when making one batch of ice.

NOTE: Set the power switch to the O (off) position if the water supply is shut off.

### **Accessing Ice and Reaching the Power Switch**

*To reach the icemaker power switch, pull the shelf above the ice bin straight out. Always be sure to replace the shelf.*

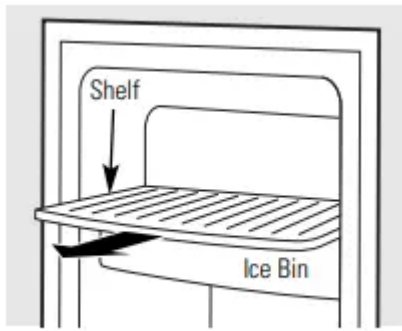

*To reach the power switch.*

To access ice, simply pull the bin forward.

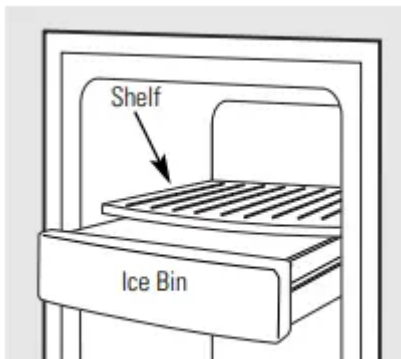

*To access ice.*

### **Icemaker Accessory Kit**

If your refrigerator did not come already equipped with an automatic icemaker, an icemaker accessory kit is available at extra cost.

Check the back of the refrigerator for the specific icemaker kit needed for your model.

### **To Use the Dispenser**

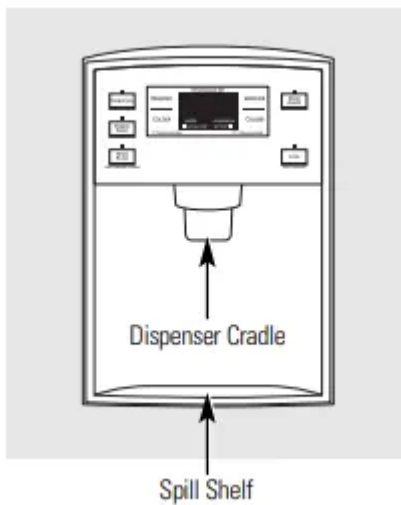

Press the glass gently against the top of the dispenser cradle.

The spill shelf is not self-draining. To reduce water spotting, the shelf should be cleaned regularly.

*If no water is dispensed when the refrigerator is first installed, there may be air in the water line system. Press the dispenser arm for at least two minutes to remove trapped air from the water line and to fill the water system. To flush out impurities in the water line, throw away the first six glassfuls of water.*

### **Locking the Dispenser**

Press the *LOCK* pad for 3 seconds to lock the dispenser and control panel. To unlock, press and hold the pad again for 3 seconds.

### **Door Alarm**

To set the alarm, press the *DOOR ALARM* pad. The indicator light will illuminate.

This alarm will sound if either door is open for more than 2 minutes. The beeping stops when you close the door.

## **Care and cleaning**

### **Cleaning the Outside**

*The door handles and trim.* Clean with a cloth dampened with soapy water. Dry with a soft cloth. Do not use wax on the door handles and trim.

*Keep the outside clean.* Wipe with a clean cloth lightly dampened with kitchen appliance wax or mild liquid dish detergent. Dry and polish with a clean, soft cloth.

Do not wipe the refrigerator with a soiled dish cloth or wet towel. These may leave a residue that can erode the paint. Do not use scouring pads, powdered cleaners, bleach or cleaners containing bleach because these products can scratch and weaken the paint finish.

### **The stainless steel panels and door handles.**

Stainless steel (on some models) can be cleaned with a commercially available stainless steel cleaner. A spray-on stainless steel cleaner works best.

Do not use appliance wax or polish on the stainless steel.

*Silver-plated plastic parts.* Wash parts with soap or other mild detergents. Wipe clean with a sponge, damp cloth or paper towel.

Do not scrub with steel-wool pads or other abrasive cleaners.

### **Cleaning the Inside**

To help prevent odors, leave an open box of baking soda in the refrigerator and freezer compartments.

Unplug the refrigerator before cleaning. If this is not practical, wring excess moisture out of sponge or cloth when cleaning around switches, lights or controls.

Use an appliance wax polish on the inside surface between the doors.

Use warm water and baking soda solution— about a tablespoon (15 ml) of baking soda to a quart (1 liter) of water. This both cleans and neutralizes odors. Rinse and wipe dry.

After cleaning the door gaskets, apply a thin layer of petroleum jelly to the door gaskets at the hinge side. This helps keep the gaskets from sticking and bending out of shape.

Avoid cleaning cold glass shelves with hot water because the extreme temperature difference may cause them to break. Handle glass shelves carefully. Bumping tempered glass can cause it to shatter.

Do not wash any plastic refrigerator parts in the dishwasher.

Silver-accented plastic parts. Wash parts with soapy water. Wipe clean with a sponge, damp cloth or paper towel.

Do not scrub with steel-wool pads or other abrasive cleaners.

## **Behind the Refrigerator**

Be careful when moving the refrigerator away from the wall. All types of floor coverings can be damaged, particularly cushioned coverings and those with embossed surfaces.

Raise the leveling legs located at the bottom front of the refrigerator.

Pull the refrigerator straight out and return it to position by pushing it straight in.

Moving the refrigerator in a side direction may result in damage to the floor covering or refrigerator.

Lower the leveling legs until they touch the floor.

When pushing the refrigerator back, make sure you don't roll over the power cord or icemaker supply line (on some models) and ensure the anti-tip bracket is engaged (if equipped).

## **Preparing for Vacation**

For long vacations or absences, remove food and unplug the refrigerator. Clean the interior with a baking soda solution of one tablespoon (15 ml) of baking soda to one quart (1 liter) of water. Leave the doors open.

Set the icemaker power switch to the *O (off)* position and shut off the water supply to the refrigerator.

If the temperature can drop below freezing, have a qualified servicer drain the water supply system (on some models) to prevent serious property damage due to flooding.

## **Preparing to Move**

Secure all loose items such as base grille, shelves and drawers by taping them securely in place to prevent damage.

When using a hand truck to move the refrigerator, do not rest the front or back of the refrigerator against the hand truck. This could damage the refrigerator. Handle only from the sides of the refrigerator.

Be sure the refrigerator stays in an upright position during moving.

## Replacing the light bulbs.

Turning the control to the 0 (off) position does not remove power to the light circuit

### Refrigerator Lights

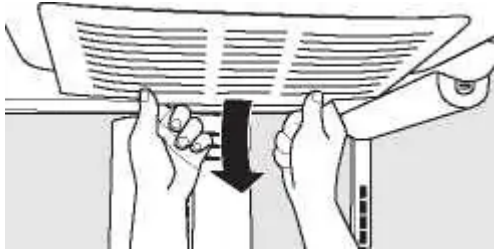

1. Unplug the refrigerator.
2. To remove the light shield, grasp the shield at the back and pull out to release the tabs at the back.
3. Rotate the shield down and then forward to release the tabs at the front of the shield.
4. After replacing with an appliance bulb of the same or lower wattage, replace the shield.
5. Plug the refrigerator back in.

*NOTE:* Appliance bulbs may be ordered from GE Parts and Accessories, 800.626.2002.

### Freezer Light

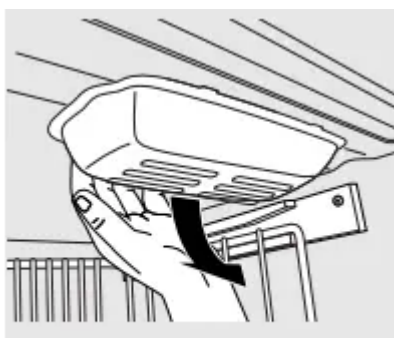

*Appearance may vary*

1. Unplug the refrigerator.
2. The bulb is located at the top of the freezer inside a light shield. To remove the shield, grasp the shield at the back and pull out to release the tabs at the back.
3. Rotate the shield down and then forward to release the tabs at the front of the shield.
4. After replacing with an appliance bulb of the same or lower wattage, replace the shield.

5. Plug the refrigerator back in

## **TROUBLESHOOTING TIPS**

### **Normal Operating Conditions.**

Newer refrigerators sound different from older refrigerators

Modern refrigerators have more features and use newer technology

#### **Do you hear what I hear? These conditions are normal.**

- The new high efficiency compressor may run faster and longer than your old refrigerator and you may hear a high-pitched hum or pulsating sound while it is operating.
- You may hear a whooshing sound when the doors close. This is due to pressure equalizing within the refrigerator.

#### **CLICKS, POPS, CRACKS and SNAPS**

- You may hear cracking or popping sounds when the refrigerator is first plugged in. This happens as the refrigerator cools to the correct temperature.
- The freezer control will click when starting or stopping the compressor.
- Defrost timer snapping in and out of the defrost cycle
- Expansion and contraction of cooling coils during and after defrost can cause a cracking or popping sound.
- On models with an icemaker, after an ice making cycle, you may hear the ice cubes dropping into the ice bucket.
- On models with a dispenser, during water dispense, weder you may hear the water lines move at initial dispense and after dispenser button is released.
- You may hear the fans spinning at high speeds. This happens when the refrigerator is first plugged in, when the doors are opened frequently or when a large amount of food is added to the refrigerator or freezer compartments. The fans are helping to maintain the correct temperatures.
- The fans change speeds in order to provide optimal cooling and energy savings.

#### **WATER SOUNDS**

- The flow of refrigerant through the cooling coils may make a gurgling noise like boiling water.
- Water dropping on the defrost heater can cause a sizzling, popping or buzzing sound during the defrost cycle.
- A water dripping noise may occur during the defrost cycle as ice melts from the evaporator and flows into the drain pan.

- Closing the door may cause a gurgling sound due to pressure equalization.

### Before you call for service...

<b><i>Problem</i></b>	<b><i>Possible Causes</i></b>	<b><i>What To Do</i></b>
<b>Refrigerator does not operate</b>	Refrigerator in defrost cycle.	• Wait about 30 minutes for defrost cycle to end.
	Control in <i>0 (off)</i> position.	• Move the control to a temperature setting.
	Refrigerator is unplugged.	• Push the plug completely into the outlet.
	The fuse is blown/circuit breaker is tripped.	• Replace fuse or reset the breaker.
<b>Vibration or rattling (slight vibration is normal)</b>	Leveling legs need adjusting.	• See <i>Level the Refrigerator</i> .

<b>Motor operates for long periods or cycles on and off frequently.</b> <b>(Modern refrigerators with more storage space and a larger freezer require more operating time. They start and stop often to maintain even temperatures.)</b>	Normal when refrigerator is first plugged in.	<ul style="list-style-type: none"> <li>• Wait 24 hours for the refrigerator to complete down.</li> </ul>
	Often occurs when large amounts of food are placed in refrigerator.	<ul style="list-style-type: none"> <li>• This is normal.</li> </ul>
	Door left open.	<ul style="list-style-type: none"> <li>• Check to see if package is holding door open.</li> </ul>
	Hot weather or frequent door openings.	<ul style="list-style-type: none"> <li>• This is normal.</li> </ul>
	Temperature control set at the coldest setting.	<ul style="list-style-type: none"> <li>• See <i>About the controls</i>.</li> </ul>
	TurboCool function has been activated.	<ul style="list-style-type: none"> <li>• This is normal when the TurboCool function is activated. See <i>About TurboCool</i> for more information.</li> </ul>
<b>Refrigerator or freezer compartment too warm</b>	Temperature controls not set cold enough.	<ul style="list-style-type: none"> <li>• See <i>About the controls</i>.</li> </ul>
	Warm weather or frequent door openings.	<ul style="list-style-type: none"> <li>• Set the temperature control one step colder. See <i>About the controls</i>.</li> </ul>
	Door left open.	<ul style="list-style-type: none"> <li>• Check to see if package is holding door open.</li> </ul>
<b>Frost or ice crystals on frozen food (frost within package is normal)</b>	Door left open.	<ul style="list-style-type: none"> <li>• Check to see if package is holding door open.</li> </ul>
	Door openings too frequent or too long.	
<b>Frequent "buzzing" sound</b>	Icemaker power switch is in the <i>I (on)</i> position, but the water supply to the refrigerator has not been connected.	<ul style="list-style-type: none"> <li>• Set the power switch to the <i>O (off)</i> position. If it is in the <i>I (on)</i> position will damage the water filter.</li> </ul>
<b>Small or hollow cubes</b>	Water filter clogged.	<ul style="list-style-type: none"> <li>• Replace filter cartridge with new cartridge or clean filter plug.</li> </ul>
	Icemaker power switch is not on.	<ul style="list-style-type: none"> <li>• Set the power switch to the <i>I (on)</i> position.</li> </ul>



<p><b>Automatic icemaker (on some models) does not work</b></p>		<p>The icemaker power light will turn green when the freezer light switch is pressed in or when the freezer door is closed.</p>
	<p>Water supply turned off or not connected.</p>	<ul style="list-style-type: none"> <li>• See <i>Installing the water line</i>.</li> </ul>
	<p>Freezer compartment too warm.</p>	<ul style="list-style-type: none"> <li>• Wait 24 hours for the refrigerator to complete defrosting.</li> </ul>
	<p>Piled up cubes in the storage bin cause the icemaker to shut off.</p>	<ul style="list-style-type: none"> <li>• Level cubes by hand.</li> </ul>
	<p>Ice cubes stuck in icemaker. (Green power light on icemaker blinking.)</p>	<ul style="list-style-type: none"> <li>• Turn off the icemaker, remove cubes and turn the icemaker back on.</li> </ul>
	<p>Icemaker light is not lit.</p>	<ul style="list-style-type: none"> <li>• This is normal when the freezer door is open. The icemaker power light will turn green when the freezer light switch is pressed in or when the freezer door is closed.</li> </ul>



<b>Ice cubes have odor/taste</b>	Food transmitting odor/taste to ice cubes.	<ul style="list-style-type: none"> <li>• Wrap foods well.</li> </ul>
	Interior of refrigerator needs cleaning.	<ul style="list-style-type: none"> <li>• See <i>Care and cleaning</i>.</li> <li>• Keep an open box of baking soda in the refrigerator and replace every three months.</li> </ul>
<b>Slow ice cube freezing</b>	Door left open.	<ul style="list-style-type: none"> <li>• Check to see if package is holding door open.</li> </ul>
	Freezer control not set cold enough.	<ul style="list-style-type: none"> <li>• See <i>About the controls</i>.</li> </ul>
<b>Refrigerator has odor</b>	Foods transmitting odor to refrigerator.	<ul style="list-style-type: none"> <li>• Foods with strong odors should be tightly wrapped.</li> <li>• Keep an open box of baking soda in the refrigerator and replace every three months.</li> </ul>
	Interior needs cleaning.	<ul style="list-style-type: none"> <li>• See <i>Care and cleaning</i>.</li> </ul>
<b>Moisture forms on outside of refrigerator</b>	Not unusual during periods of high humidity.	<ul style="list-style-type: none"> <li>• Wipe surface dry and reset the refrigerator to one setting colder.</li> </ul>
<b>Moisture collects inside (in humid weather, air carries moisture into refrigerator when doors are opened)</b>	Too frequent or too long door openings.	
<b>Refrigerator or freezer compartment light does not work</b>	No power at outlet.	<ul style="list-style-type: none"> <li>• Replace fuse or reset the breaker.</li> </ul>
	Light bulb burned out or loose.	<ul style="list-style-type: none"> <li>• See <i>Replacing the light bulbs</i>.</li> </ul>
<b>Door/drawer does not close by itself</b>	Leveling legs need adjusting.	<ul style="list-style-type: none"> <li>• See <i>Installing the Refrigerator</i>.</li> </ul>

<p><b>Freezer door/drawer pops open when refrigerator door is closed</b></p>	<p>This is normal if, after popping open, the freezer door/drawer closed on its own.</p>	<ul style="list-style-type: none"> <li>• This indicates that there is a good seal on the door/drawer. If the freezer door/drawer does not automatically close after popping open, then there is a problem.</li> </ul> <p><i>Problem: Door/drawer does not close by itself.</i></p>
<p><b>Hot air from bottom of refrigerator</b></p>	<p>Normal air flow cooling motor. In the refrigeration process, it is normal that heat is expelled in the area under the refrigerator. Some floor coverings will discolor at these normal and safe temperatures.</p>	
<p><b>Food freezing in the refrigerator</b></p>	<p>Food too close to the air vent at the back of the refrigerator.</p>	<ul style="list-style-type: none"> <li>• Move the food away from the air vent.</li> </ul>
	<p>Refrigerator control is set too cold.</p>	<ul style="list-style-type: none"> <li>• Move the refrigerator control to a warmer temperature setting one increment at a time.</li> </ul>
<p><b>Orange glow in the freezer</b></p>	<p>Defrost heater is on.</p>	<ul style="list-style-type: none"> <li>• This is normal.</li> </ul>



<b>Water has poor taste/odor</b>	Water dispenser has not been used for a long time.	<ul style="list-style-type: none"> <li>• Dispense water until all water in system is replenished.</li> </ul>
<b>Water in first glass is warm</b>	Normal when refrigerator is first installed.	<ul style="list-style-type: none"> <li>• Wait 24 hours for the refrigerator to complete down.</li> </ul>
	Water dispenser has not been used for a long time.	<ul style="list-style-type: none"> <li>• Dispense water until all water in system is replenished.</li> </ul>
	Water system has been drained.	<ul style="list-style-type: none"> <li>• Allow several hours for replenished supply to</li> </ul>
<b>Water dispenser does not work</b>	Water supply line turned off or not connected.	<ul style="list-style-type: none"> <li>• See <i>Installing the water line</i>.</li> </ul>
	Water filter clogged.	<ul style="list-style-type: none"> <li>• Replace filter cartridge or remove filter and plug.</li> </ul>
	Air may be trapped in the water system.	<ul style="list-style-type: none"> <li>• Press the dispenser arm for at least 2 minutes.</li> </ul>
	Water in reservoir is frozen because the controls are set too cold.	<ul style="list-style-type: none"> <li>• Set the refrigerator control to a warmer setting and wait 24 hours. If water does not dispense after 24 hours, call for service.</li> </ul>
<b>Water spurting from dispenser</b>	Newly-installed filter cartridge.	<ul style="list-style-type: none"> <li>• Run water from the dispenser for 3 minutes (2 gallons).</li> </ul>
<b>No water or ice cube production</b>	Supply line or shutoff valve is clogged.	<ul style="list-style-type: none"> <li>• Call a plumber.</li> </ul>
	Water filter clogged.	<ul style="list-style-type: none"> <li>• Replace filter cartridge or remove filter and plug.</li> </ul>
	Filter cartridge not properly installed.	<ul style="list-style-type: none"> <li>• Remove and reinstall filter cartridge, being careful that it locks into place. The blade on the end of the cartridge should be positioned vertically.</li> </ul>
<b>Water is leaking from dispenser</b>	Glass not being held under the dispenser long enough after button is released.	<ul style="list-style-type: none"> <li>• Hold the glass underneath the dispenser for 10 seconds after releasing the dispenser button. Water may continue to dispense after the button is released.</li> </ul>



**Warning**

This content is compiled from multiple sources and is provided for reference purposes only. It may not be complete or fully applicable to all situations. If you are unable to resolve your issue, please contact the product manufacturer or an authorized service provider for official support.

---

Document generated by [ManualsFile](#)

