

User Guide for Range

Feature Guide

WARNING Food Poisoning Hazard Do not let food sit for more than one hour before or after cooking. Doing so can result in food poisoning or sickness.



Keypad	Feature	Instructions
MANUAL CONVECT MODES	Convection cooking	<ol style="list-style-type: none"> 1. Press MANUAL CONVECT MODES until the desired convection mode appears in the display. 2. Press START. 3. Press the number keypads to set the desired temperature. 4. Press START. 5. Insert food when prompted. 6. To change the temperature, repeat steps 3 and 4. 7. Press CANCEL when finished.
AUTO CONVECT MODES	Convection cooking	<ol style="list-style-type: none"> 1. Press AUTO CONVECT MODES until the desired convection mode appears in the display. 2. Press START. 3. Press the number keypads to set the desired temperature. 4. Press START. 5. Press the number keypads to set the desired cook time. 6. Press START. 7. Insert food when prompted. 8. To change the temperature, repeat steps 3 through 6. 9. Press CANCEL when finished.
KEEP WARM	Hold warm	<p>Food must be at serving temperature before placing it in the warmed oven.</p> <ol style="list-style-type: none"> 1. Press KEEP WARM. 2. Set the desired temperature between 145°F and 190°F (63°C and 88°C) using the number keypads. The default temperature is 170°F (75°C). 3. Press START. 4. Press CANCEL when finished.



PROOF	Proofing bread	<ol style="list-style-type: none"> 1. Place prepared dough in oven. Press PROOF. 2. Press START. Let the dough rise until nearly doubled in size. Proofing time may vary depending on dough type and quantity. 3. Press CANCEL when finished proofing. <p>Refer to the “Proofing Bread” section for more information.</p>
FAVORITE	Saved favorite	The Favorite keypad stores the oven mode, cook time, and temperature for your favorite recipe. To save or use favorite, see the “Favorite” section.
DELAY START	Delayed start	<p>The Delay Start keypad is used to enter the starting time for an oven function with a delayed start. Delay Start should not be used for foods such as breads and cakes because they may not bake properly.</p> <p>To set a Timed Cook or a Delayed Timed Cook, see the “Cook Time” section</p>
COOK TIME	Timed cooking	<p>Timed cooking allows the oven to be set to turn on at a certain time of day, cook for a set length of time, and/or shut off automatically.</p> <p>To set a Timed Cook or a Delayed Timed Cook, see the “Cook Time” section.</p>
AQUALIFT SELF CLEAN	Clean cycle	See the “Clean Cycle” section.
DOWNDRAFT FAN HIGH/LOW/AUTO OFF/OFF	Downdraft fan	<p>Press DOWNDRAFT FAN HIGH or DOWNDRAFT FAN LOW to turn on the Downdraft Fan at the desired speed.</p> <p>Press DOWNDRAFT FAN OFF to turn off the Downdraft Fan immediately.</p> <p>Press DOWNDRAFT FAN AUTO OFF to automatically turn off the Downdraft Fan after a set time. To add 15 minutes to the set time, up to 1 hour, press DOWNDRAFT FAN AUTO OFF again.</p>

		<p>If the Downdraft Fan is Off, pressing Downdraft Fan Auto Off will turn the Downdraft Fan On at High speed. If the Downdraft Fan is already on, pressing Downdraft Fan Auto Off will not change the Downdraft Fan speed.</p>
START (Hold 3 Sec to Lock)	Oven control lockout	<ol style="list-style-type: none"> 1. Check that the oven is OFF. 2. Press and hold START (Hold 3 Sec to Lock) for 3 seconds. 3. A tone will sound, and "Control Locked" will scroll, and then "Locked" will be displayed. 4. Repeat to unlock. No keypads will function with the controls locked. The cooktop functions are not affected by the oven control lockout.
OPTIONS/CLOCK	Energy save	<ol style="list-style-type: none"> 1. Press OPTIONS/CLOCK until "ENERGY SAVE" is displayed. 2. The current setting will be displayed. 3. Press the "1" keypad to adjust the setting. 4. Press CANCEL to exit and display the time of day. <p>If Energy Save is ON, the range will go into Sleep mode after 5 minutes of inactivity. Any keypad press will activate the display. If Energy Save is OFF, the display will be ON at all times.</p>

Electronic Oven Controls

Control Display

The display will flash when powered up or after a power loss.

Press CANCEL to clear. When the oven is not in use, the time of day is displayed. If the range is in Energy Save mode, the display will be blank when not in use.

Tones

Tones are audible signals, indicating the following:

One Tone

- Valid keypad press
- Oven is preheated (long tone).

- Function has been entered.
- Reminder, repeating each minute after the end-of-cycle tones

Three Tones

- Invalid keypad press

Four Tones

- End-of-cycle

Use the Options/Clock keypad to change the tone settings.

Energy Save

The Energy Save mode puts the range into Sleep mode and reduces energy consumption.

To Activate the Energy Save Mode:

1. Press OPTIONS/CLOCK until "ENERGY SAVE" is displayed.
2. The current setting will be displayed.
3. Press the "1" keypad to adjust the setting.
4. Press CANCEL to exit and display the time of day.
5. The setting will be activated after 5 minutes.

To Deactivate the Energy Save Mode:

1. Press OPTIONS/CLOCK until "ENERGY SAVE" is displayed.
2. The current setting will be displayed.
3. Press the "1" keypad to adjust the setting.
4. Press CANCEL to exit and display the time of day.
5. The clock will reappear in the display and the range can be operated as usual.

Settings

Many features of the oven control can be adjusted to meet your personal needs. These changes are made using the Options/Clock keypad.

Use the Options/Clock keypad to scroll through the features that can be changed. Each press of the Options/Clock keypad will advance the display to the next setting. After selecting the feature to be changed, the control will prompt you for the required input. Then press START or CANCEL to exit and display the time of day. Details of all of the feature changes are explained in the following sections.

Press CANCEL to exit Settings.

Clock

The Clock can use a 12- or 24-hour cycle.

1. Press OPTIONS/CLOCK until "CLOCK" is displayed.
2. Use the number keypads to set the time of day.
3. Press START to change the time.
4. Press "3" for AM or "6" for PM.

Fahrenheit and Celsius

The temperature is preset to Fahrenheit but can be changed to Celsius.

1. Press OPTIONS/CLOCK until "TEMP UNIT" is displayed.
2. The current setting will be displayed.
3. Press the "1" keypad to adjust the setting.
4. Press START or CANCEL to exit and display the time of day.

Audible Tones Disable

Turns off all tones, including the end-of-cycle tone and keypress tones. Reminder tones are still active when all tones are disabled.

1. Press OPTIONS/CLOCK until "SOUND" is displayed.
2. The current setting will be displayed.
3. Press the "1" keypad to adjust the setting.
4. Press START or CANCEL to exit and display the time of day

Sound Volume

Sets the volume of the tone to either high or low.

1. Press OPTIONS/CLOCK until "SOUND VOLUME" is displayed.
2. The current setting will be displayed.
3. Press the "1" keypad to adjust the setting.
4. Press START or CANCEL to exit and display the time of day.

End-of-Cycle Tone

Activates or turns off the tones that sound at the end of a cycle.

1. Press OPTIONS/CLOCK until "END TONE" is displayed.
2. The current setting will be displayed.
3. Press the "1" keypad to adjust the setting.
4. Press START or CANCEL to exit and display the time of day.

Keypress Tones

Activates or turns off the tones when a keypad is pressed.

1. Press OPTIONS/CLOCK until “KEYPRESS TONE” is displayed.
2. The current setting will be displayed.
3. Press the “1” keypad to adjust the setting.
4. Press START or CANCEL to exit and display the time of day.

Reminder Tones Disable

Turns off the short repeating tone that sounds every 1 minute after the end-of-cycle tones.

1. Press OPTIONS/CLOCK until “REMINDER TONE” is displayed.
2. The current setting will be displayed.
3. Press the “1” keypad to adjust the setting.
4. Press START or CANCEL to exit and display the time of day.

12/24 Hour Clock

1. Press OPTIONS/CLOCK until “12/24 HOUR” is displayed.
2. The current setting will be displayed.
3. Press the “1” keypad to adjust the setting.
4. Press START or CANCEL to exit and display the time of day.

Demo Mode

IMPORTANT: This feature is intended for use on the sales floor with 120 V power connection and permits the control features to be demonstrated without the oven turning on. If this feature is activated, the oven will not work.

1. Press OPTIONS/CLOCK until “DEMO MODE” is displayed.
2. The current setting will be displayed.
3. Press the “1” keypad to adjust the setting.
4. Press START or CANCEL to exit and display the time of day.

Sabbath Mode

The Sabbath mode sets the oven to remain ON in a bake setting until turned off.

When the Sabbath mode is set, only the Bake cycle will operate.

All other cooking and cleaning cycles are disabled. No tones will sound and the displays will not indicate temperature changes.

When the oven door is opened or closed, the oven light will not turn on or off and the heating elements will not turn on or off immediately.

To Enable Sabbath Mode Capability (One Time Only):

1. Press OPTIONS/CLOCK until "SABBATH" is displayed.
2. The current setting will be displayed.
3. Press the "1" keypad to adjust the setting.
4. Press START or CANCEL to exit and display the time of day.

12-Hour Shutoff

The oven control is set to automatically shut off the oven 12 hours after the oven initiates a cook or clean function. This will not interfere with any timed or delay cook functions.

1. Press OPTIONS/CLOCK until "12Hr AUTO_OFF" is displayed.
2. The current setting will be displayed.
3. Press the "1" keypad to adjust the setting.
4. Press START or CANCEL to exit and display the time of day.

Languages - Scrolling Display Text

Language options are English, Spanish, and French.

1. Press OPTIONS/CLOCK until "LANGUAGE" is displayed.
2. The current setting will be displayed.
3. Press the "1" or "2" keypad to select the desired language.
4. Press START or CANCEL to exit and display the time of day.

Oven Temperature Offset Control

IMPORTANT: Do not use a thermometer to measure oven temperature. Elements will cycle on and off as needed to provide consistent temperature but may run slightly hot or cool at any point in time due to this cycling. Most thermometers are slow to react to temperature change and will not provide an accurate reading due to this cycling.

The oven provides accurate temperatures; however, it may cook faster or slower than your previous oven, so the temperature can be adjusted to personalize it for your cooking needs. It can be changed to Fahrenheit or Celsius.

To Adjust Oven Temperature:

1. Press OPTIONS/CLOCK until "TEMP CALIB" is displayed.
2. On some models, press "1" to adjust the drawer temperature calibration. Press START, wait 10 seconds for the display to change, and then continue with Step 3. **OR** Press START to adjust the oven temperature calibration. Wait seconds for the display to change, and then continue with Step 3.

3. Press the “3” keypad to increase the temperature in 5°F (3°C) increments or press the “6” keypad to decrease the temperature in 5°F (3°C) increments. The offset range is from -30°F to +30°F (-18°C to +18°C).
4. Press START or CANCEL to exit and display the time of day.

Cooktop

WARNING Fire Hazard Do not let the burner flame extend beyond the edge of the pan. Turn off all controls when not cooking. Failure to follow these instructions can result in death or fire

Electric igniters automatically light the surface burners when control knobs are turned to IGNITE. Before setting a control knob, place filled cookware on the grate. Do not operate a burner using empty cookware or without cookware on the grate.

To Set:

- 1. Push in and turn knob counterclockwise to IGNITE. All surface burners will click. Only the burner with the control knob turned to IGNITE will produce a flame.
- 2. Turn knob to anywhere between HIGH and LOW.

REMEMBER: When range is in use, the entire cooktop area may become hot.

Power Failure

In case of prolonged power failure, the surface burners can be lit manually. Hold a lit match near a burner, and then turn knob counterclockwise to IGNITE. After burner lights, turn knob to desired setting.

Surface Burners

IMPORTANT: Do not obstruct the flow of combustion and ventilation air around the burner grate edges.

Burner cap: Always keep the burner cap in place when using a surface burner. A clean burner cap will help avoid poor ignition and uneven flames. Always clean the burner cap after a spillover, and routinely remove and clean the caps according to the “General Cleaning” section.

NOTE: Each round burner cap is marked with a letter indicating the burner size.

Alignment: Be sure to align the gas tube opening in the burner base with the orifice holder on the cooktop and the igniter electrode with the notch in the burner base.

NOTE: Each round burner base is marked with a letter indicating the burner size.

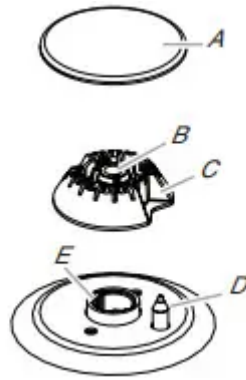

A. Burner cap

B. Gas tube opening

C. Burner base

D. Igniter electrode

E. Orifice holder

Gas Tube Opening: Gas must flow freely throughout the gas tube opening for the burner to light properly. Keep this area free of soil, and do not allow spills, food, cleaning agents or any other material to enter the gas tube opening. Keep spillovers out of the gas tube opening by always using a burner cap.

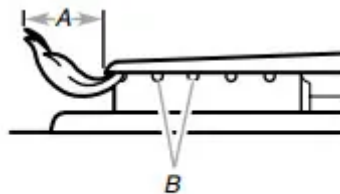

A. 1 to 1 1/2" (2.5 to 3.8 cm)

B. Burner ports

Burner Ports: Check burner flames occasionally for proper size and shape as shown in the previous illustration. A good flame is blue in color, not yellow. Keep this area free of soil, and do not allow spills, food, cleaning agents or any other material to enter the burner ports.

To Clean:

IMPORTANT: Before cleaning, make sure all controls are off and the cooktop is cool. Do not use oven cleaners, bleach or rust removers. Do not wash in the dishwasher.

1. Remove the burner cap and the burner base and clean according to the "General Cleaning" section.
2. Clean the gas tube opening with a damp cloth.
3. Clean clogged burner ports with a straight pin as shown. Do not enlarge or distort the port. Do not use a wooden toothpick. If the burner needs to be adjusted, contact a trained repair specialist.

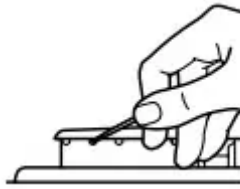

4. Replace the burner base. Each round burner base is marked with a letter indicating the burner size. See the following illustration for burner positions:

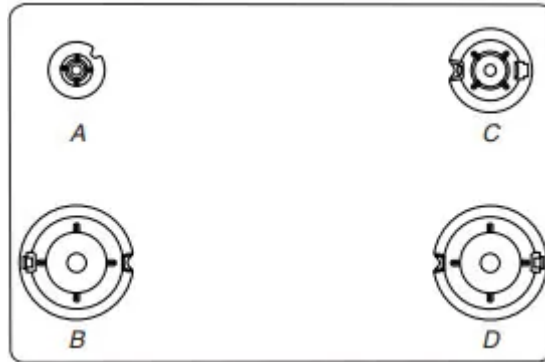

A. Small (S)

B. Large (L)

C. Medium (M)

D. Large (L)

5. Replace the burner cap, making sure it is properly aligned with the burner base. The burner cap should not rock or wobble when properly aligned.

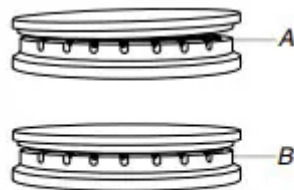

A. Incorrect
B. Correct

IMPORTANT: The bottom of the small and medium caps are different. Do not put the wrong size burner cap on the burner base.

NOTE: Each round burner cap is marked with a letter indicating the burner size.



6. Turn on the burner. If the burner does not light, check cap alignment. If the burner still does not light, turn off the burner. Do not service the burner yourself. Contact a trained repair specialist.

Surface Grates

The grates must be properly positioned before cooking. In the proper position, the grates should be flush and level. Improper installation of the grates may result in chipping or scratching of the cooktop.

To ensure proper positioning, align bumpers on grate bottom with the indentations in the cooktop.

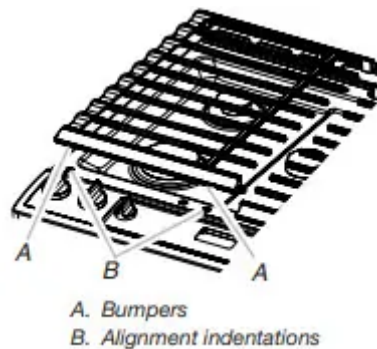

The surface grates interlock using the hooks on the middle grate and the indents on the end grates. To remove the grates, remove the end grates first, and then remove the middle grate. To replace the grates, replace the middle grate first, and then place the end grates on either side.

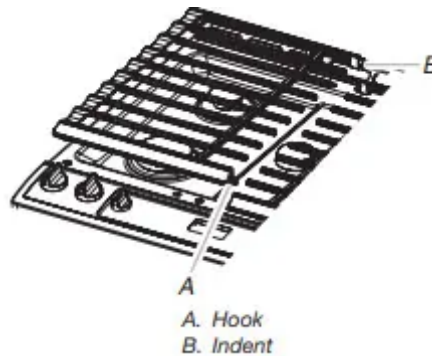

Although the burner grates are durable, they will gradually lose their shine and/or discolor due to the high temperatures of the gas flame.

Burner Size

Select a burner that best fits your cookware. See the following illustration and chart.

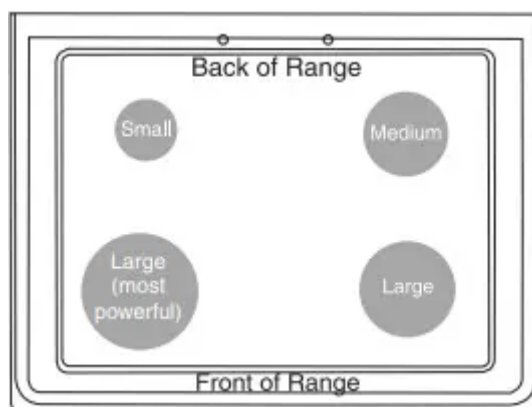

Burner Size	Recommended Use
Small	<ul style="list-style-type: none"> ■ Low-heat cooking ■ Melting chocolate or butter
Medium	<ul style="list-style-type: none"> ■ Multipurpose burner
Large	<ul style="list-style-type: none"> ■ For large cookware
Large (most powerful)	<ul style="list-style-type: none"> ■ For large cookware ■ Most powerful burner

Griddle

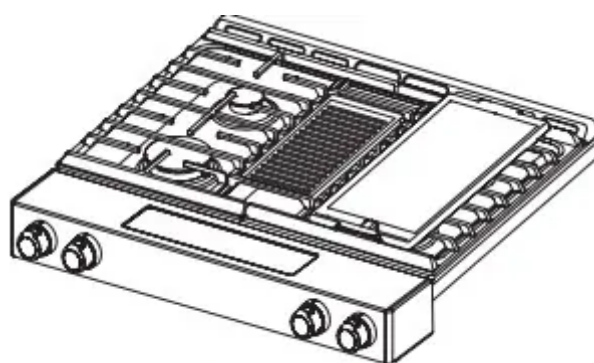

Griddle installed on right side of cooktop

To Use the Griddle:

1. Locate the griddle on the right side grate, as shown. The locating feet on the bottom of the griddle will engage the grate tines to keep the griddle from sliding.
2. Before each use, brush on a thin layer of cooking oil to keep food from sticking. Cooking sprays may leave a sticky residue on the griddle that is hard to remove.
3. Preheat the griddle for 5 minutes. Preheating the griddle slowly will ensure even heat distribution and will avoid warping the griddle.

4. For preheating and cooking, set the front burner to the lowest heat setting and the rear burner to medium-high heat for best performance.

NOTE: The griddle may also be used on the left side grate. For best results, the rear burner setting should be set to MediumLow or Medium, and the front burner setting should be set to Low.

To Clean the Griddle:

1. Let the griddle cool, and then empty the drip tray.
2. See the “General Cleaning” section for cleaning instructions.
3. Store griddle in a cool dry place.

Cookware

IMPORTANT: Do not leave empty cookware on a hot surface cooking area, element or surface burner.

Ideal cookware should have a flat bottom, straight sides and a well-fitting lid, and the material should be of medium-to-heavy thickness.

Rough finishes may scratch the cooktop or coils. Aluminum and copper may be used as a core or base in cookware. However, when used as a base they can leave permanent marks on the surfaces.

Cookware material is a factor in how quickly and evenly heat is transferred, which affects cooking results. A nonstick finish has the same characteristics as its base material. For example, aluminum cookware with a nonstick finish will take on the properties of aluminum.

Cookware with nonstick surfaces should not be used under the broiler.

Check for flatness by placing the straight edge of a ruler across the bottom of the cookware. While you rotate the ruler, no space or light should be visible between it and the cookware.

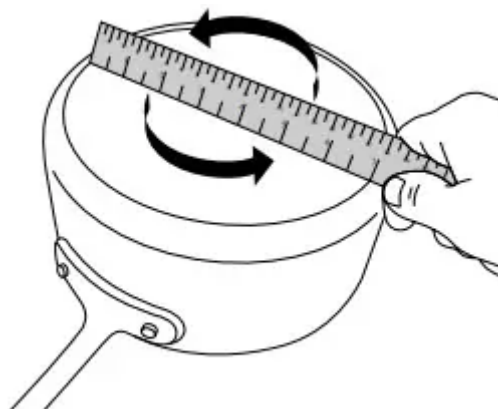

Use the following chart as a guide for cookware material characteristics.

Cookware	Characteristics
Aluminum	<ul style="list-style-type: none"> ■ Heats quickly and evenly ■ Suitable for all types of cooking. ■ Medium or heavy thickness is best for most cooking tasks. ■ May leave aluminum residues, which may be diminished if cleaned immediately after cooking.
Cast iron	<ul style="list-style-type: none"> ■ Heats slowly and evenly. ■ Good for browning and frying. ■ Maintains heat for slow cooking. ■ Rough edges or burrs may scratch the cooktop.
Ceramic or Ceramic glass	<ul style="list-style-type: none"> ■ Follow manufacturer's instructions ■ Heats slowly, but unevenly. ■ Ideal results on low to medium heat settings. ■ May scratch the cooktop.
Copper	<ul style="list-style-type: none"> ■ Heats very quickly and evenly. ■ May leave copper residues, which may be diminished if cleaned immediately after cooking. ■ Can leave a permanent stain or bond to the cooktop if overheated
Earthenware	<ul style="list-style-type: none"> ■ Follow manufacturer's instructions. ■ Use on low heat settings. ■ May scratch the cooktop.
Porcelain enamel-onsteel or cast iron	<ul style="list-style-type: none"> ■ See stainless steel or cast iron. ■ Porcelain enamel bakeware without the metal base may bond to the cooktop if overheated.
Stainless steel	<ul style="list-style-type: none"> ■ Heats quickly, but unevenly.

- A core or base of aluminum or copper on stainless steel provides even heating.

Use flat-bottomed cookware for best cooking results and energy efficiency. The cookware should be about the same size as the cooking area outlined on the cooktop. Cookware should not extend more than 1/2" (1.3 cm) outside the area.

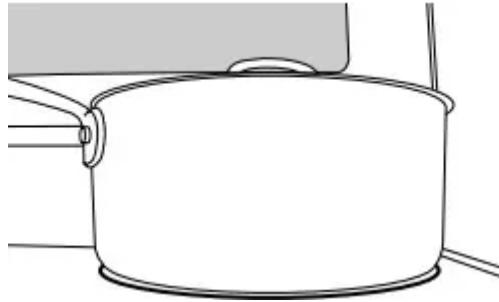

Home Canning

When canning for long periods, alternate the use of surface burners between batches. This allows time for the most recently used areas to cool.

- Center the canner on the grate above the burner.
- Do not place canner on 2 surface burners at the same time.
- For more information, contact your local agricultural extension office, or refer to published home canning guides. Companies that manufacture home canning products can also offer assistance.

Oven

Odors and smoke are normal when the oven is used the first few times or when it is heavily soiled.

IMPORTANT: The health of some birds is extremely sensitive to the fumes given off by the oven. Exposure to the fumes may result in death to certain birds. Always move birds to another closed and well-ventilated room.

Aluminum Foil

IMPORTANT: To avoid permanent damage to the oven bottom finish, do not line the oven bottom with any type of foil or liner.

For best cooking results, do not cover entire oven rack with foil because air must be able to move freely.

Positioning Racks and Bakeware

IMPORTANT: To avoid permanent damage to the porcelain finish, do not place food or bakeware directly on the oven door or bottom.

Bakeware

To cook food evenly, hot air must be able to circulate. Allow cm) of space around bakeware and oven walls. Make sure that no bakeware piece is directly over another.

Racks

- Position racks before turning on the oven.
- Do not position racks with bakeware on them.
- Make sure racks are level.

To position a rack, pull it out to the stop position, raise the front edge, and then lift out. Use the following illustration and charts as guides.

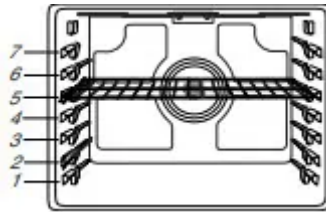

The oven has 7 positions for a flat rack, as shown in the previous illustration and the following table.

Flat Rack Position*	Type of Food
7	Broiling/searing meats, hamburgers, steaks
6	Broiled meats, poultry, fish
3 or 4	Most baked goods, casseroles, frozen foods
2	Roasted meats
1	Large roasts or poultry

For hamburger patties to have a well-seared exterior and a rare interior, use a flat rack in rack position 7. Side 1 should cook for approximately 2 1/2 to 3 1/2 minutes. Side 2 should cook for approximately 4 to 5 minutes. Expect a moderate degree of smoke when broiling.

*If your model has a Max Capacity Oven Rack, the recessed ends must be placed in the rack position above the desired position of the food. See the following illustration.

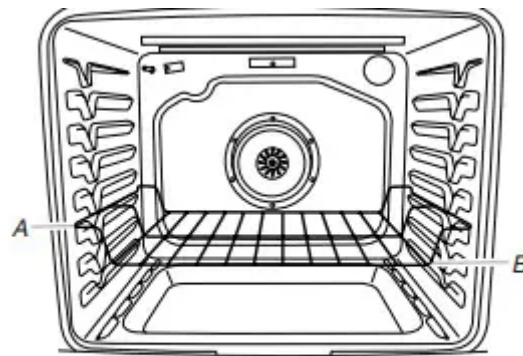

A. Ends of rack in position 3
B. Food in position 2

IMPORTANT: These rack positions are for flat racks. If a Max Capacity Oven Rack is used, the rack position must be adjusted as shown in the previous figure.

Multiple Rack Cooking

2-rack (non-convection): Use rack positions 2 and 5 or 3 and 6.

2-rack (convection): Use rack positions 2 and 5 or 3 and 6.

3-rack (convection): Use rack positions 2 and 7 and a Max Capacity Oven Rack in rack position 5.

Baking Cookies and Layer Cakes on 2 Racks

Baking Layer Cakes

For best results when baking cakes on 2 racks, use the Bake function, a flat rack in rack position 3 and a roll-out rack in rack position 5. Place the cakes on the racks as shown. Keep at least 3" (7.6 cm) of space between the front of the racks and the front cakes.



Baking Cookies

For best results when baking cookies on 2 racks, use the Convection Bake function, a flat rack in rack position 3 and a roll-out rack in rack position 4.

Sabbath Mode

The Sabbath mode sets the oven to remain on in a bake setting until turned off.

When the Sabbath mode is set, only the Bake cycle will operate. All other cooking and cleaning cycles are disabled. No tones will sound and the displays will not indicate temperature changes.

When the oven door is opened or closed, the oven light will not turn on or off and the heating elements will not turn on or off immediately.

To Enable Sabbath Mode Capability (One Time Only):

1. Press OPTIONS/CLOCK until "SABBATH" is displayed. "OFF. Press (1) for On" will scroll in the display.
2. Press the "1" keypad. "ON. Press (1) for Off" will scroll in the display. Sabbath mode can be activated for baking.
3. Press START or CANCEL to exit and display the time of day.

NOTE: To disable the Sabbath mode, repeat steps 1 through 3 to change the status from "SABBATH ON" to "SABBATH OFF."

To Activate Sabbath Mode:

1. Press BAKE for the desired oven.
2. Press the number keypad to set a temperature other than F (177°C).
3. Press START. For timed cooking in Sabbath mode, press COOK TIME and then the number keypads to set the desired cook time.
4. Press OPTIONS/CLOCK. Three tones will sound. Then press "SAb" will appear in the display.

To Adjust Temperature (When Sabbath Mode Is Running):

1. Press the number keypad as instructed by the scrolling text to select the new temperature. **NOTE:** The temperature adjustment will not appear on the display. The scrolling text will be shown on the display as it was before the keypad was pressed.
2. Press START.

To Deactivate Sabbath Mode:

Press OPTIONS/CLOCK, and then press "7" to return to regular baking, or press CANCEL for the desired oven to turn off the range.

NOTE: No tones will sound while deactivating Sabbath mode

Baking and Roasting

Preheating

When beginning a Bake, Convect Bake, or Convect Roast cycle, the oven will begin preheating after Start is pressed. The oven will take approximately 12 to 15 minutes to reach 350°F (177°C) with all of the oven racks provided with your oven inside the oven cavity. Higher temperatures will take longer to preheat. The preheat cycle rapidly increases the oven temperature. The actual oven temperature will go above your set temperature to offset the heat lost when your oven door is opened to insert food. This ensures that when you place your food in the oven, the oven will begin at the proper temperature. Insert your food when the preheat tone sounds. Do not open the door during preheat before the tone sounds.

Oven Temperature

While in use, the oven elements will cycle on and off as needed to maintain a consistent temperature, but they may run slightly hot or cool at any point in time due to this cycling. Opening the oven door while in use will release the hot air and cool the oven which could impact the cooking time and performance. It is recommended to use the oven light to monitor cooking progress.

NOTE: On models with convection, the convection fan may run in the non-convection Bake mode to improve oven performance.

Temperature Management System

The Temperature Management System electronically regulates the oven heat levels during preheat and Bake to maintain a precise temperature range for optimal cooking results. The bake and broil elements or burners cycle on and off in intervals. On convection range models, the fan will run while preheating and may be cycled on and off for short intervals during Bake to provide the best results. This feature is automatically activated when the oven is in use.

Before baking and roasting, position racks according to the Positioning Racks and Bakeware” section. When roasting, it is not necessary to wait for the oven preheat cycle to end before putting food in, unless it is recommended in the recipe.

Broiling

When broiling, preheat the oven for 2 minutes before putting food in, unless recommended otherwise in the recipe. Position food on grid in a broiler pan, and then place it in the center of the oven rack.

IMPORTANT: Close the door to ensure proper broiling temperature.

Changing the temperature when broiling allows more precise control when cooking. The lower the broil setting is, the slower the cooking. Thicker cuts and unevenly shaped pieces of meat, fish, and poultry may cook better at lower broil settings. Use rack or 7 for broiling. Refer to the “Positioning Racks and Bakeware” section for more information.

On lower settings, the broil element will cycle on and off to maintain the proper temperature.

- For best results, use a broiler pan and grid. It is designed to drain juices and help avoid spatter and smoke. If you would like to purchase a broiler pan, one may be ordered. See the “Accessories” section.

Convection Cooking

In a convection oven, the fan-circulated hot air continually distributes heat more evenly than the natural movement of air in a standard thermal oven. This movement of hot air helps maintain a consistent temperature throughout the oven, cooking foods more evenly, crisping surfaces while sealing in moisture and yielding crustier breads

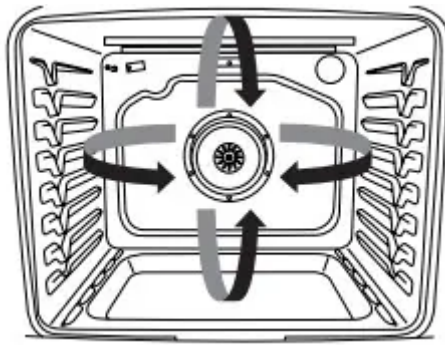

During convection baking or roasting, the bake, broil, and convection elements cycle on and off in intervals while the fan circulates the hot air. During convection broiling, the broil and convection elements cycle on and off.

If the oven door is opened during convection cooking, the fan will turn off immediately. It will come back on when the oven door is closed.

With convection cooking, most foods can be cooked at a lower temperature and/or a shorter cooking time than in a standard thermal oven. When using Manual Convection Modes, reduce the time and temperature when setting the oven. Use the following chart as a guide.

Convection Mode	Time/Temperature Guidelines
Convection Bake	25°F (15°C) lower temperature, possible shortened cooking time
Convection Roast	Cooking time shortened by up to 30%
Convection Broil	Shortened cooking time

When using Auto Convection Modes, the oven will automatically adjust the time and temperature for the selected mode.

Convection Modes

Manual Convection Modes:

Convection Bake - multiple-rack baking or cookies, biscuits, breads, casseroles, tarts, tortes, cakes

Convection Roast - whole chicken or turkey, vegetables, pork roasts, beef roasts

Convection Broil - thicker cuts or unevenly shaped pieces of meat, fish, or poultry

Auto Convection Modes:

Meats - Chicken: whole and pieces; meat loaf; roasts: pork, beef, ham

Baked Goods - Biscuits, quick breads, yeast breads, cakes, cookies, casseroles

Others - Frozen convenience foods: french fries, nuggets, fish sticks, lasagna, pizza



Proofing Bread

Proofing bread prepares the dough for baking by activating the yeast. Follow the recipe directions as a guide. Proof should be used for fresh dough, thawed dough, and for the first and second rise.

To Proof:

Before first proofing, place the dough in a lightly greased bowl and cover loosely with wax paper, coated with shortening. Place on rack guide 2 and close the oven door.

NOTE: If the temperature of the oven is greater than 120°F (49°C), "Oven Cooling" will be displayed until the temperature is less than 120°F (49°C).

1. Press PROOF.
2. Press START. Let the dough rise until nearly doubled in size. Proofing time may vary depending on dough type and quantity.
3. Press CANCEL when finished proofing.

Before second proofing, shape the dough, place it in baking pan(s), and cover loosely. Follow the same placement and control steps above. Before baking, remove the cover.

NOTE: If the oven temperature is greater than 120°F (49°C), the display will indicate "Oven Cooling" until the temperature is below 120°F (49°C).

Favorite

Favorite stores the oven mode and temperature for your favorite recipe.

To Save a Recipe:

1. While the oven is being used for Bake, Broil, Convection Bake, Convection Roast or Convection Broil, press and hold FAVORITE for 3 seconds.
2. The current oven mode, cook time and temperature will be displayed. "SAVED" will be displayed. The recipe has been saved.

NOTE: Only one recipe can be saved at a time. Saving a new recipe will overwrite a previously saved recipe.

To Select the Favorite Recipe:

1. Press FAVORITE. The saved oven mode and temperature will be displayed. **NOTE:** Favorite does not store cook times.
2. Press START.
3. Once the recipe is selected, oven will begin preheating to the set program.
4. To change the temperature, press the number keypads to set the desired temperature.
5. Press START.
6. To change the cook time, press COOK TIME.

7. Press the number keypads to set the desired cook time.
8. Press START.
9. Press CANCEL when finished cooking.

Cook Time

WARNING Food Poisoning Hazard Do not let food sit in oven more than one hour before or after cooking. Doing so can result in food poisoning or sickness.

To Set a Timed Cook:

1. Press BAKE or BROIL, or press AUTO CONVECT MODES or MANUAL CONVECT MODES until the desired convection mode appears on the display.
2. Press the number keypads to enter a temperature other than the one displayed.
3. Press COOK TIME. The Cook Time oven indicator light will light up.
4. Press the number keypads to enter the length of time to cook.
5. Press START. The display will count down the time. When the time ends, the oven will shut off automatically.
6. Press CANCEL for the desired oven to clear the display.

To Set a Delayed Timed Cook:

1. Press BAKE or BROIL, or press AUTO CONVECT MODES or MANUAL CONVECT MODES until the desired convection mode appears on the display.
2. Press the number keypads to enter a temperature other than the one displayed.
3. Press COOK TIME. The Cook Time oven indicator light will light up.
4. Press number keypads to enter the length of time to cook.
5. Press DELAY START.
6. Press number keypads to enter the number of hours and/or minutes you want to delay the start time.
7. Press START. When the start time is reached, the oven will automatically turn on. The temperature and/or time settings can be changed anytime after the oven turns on by repeating steps 2 through 4. When the set cook time ends, the oven will shut off automatically.
8. Press CANCEL for the desired oven to clear the display.

Oven Light

The oven light is a standard 40-watt appliance bulb. Before replacing, make sure the oven and cooktop are cool and the control knobs are in the Off position.

To Replace:

1. Unplug range or disconnect power.
2. Turn the glass bulb cover in the back of the oven counterclockwise to remove.
3. Turn bulb counterclockwise to remove from socket.
4. Replace bulb by turning clockwise.
5. Replace bulb cover by turning clockwise.
6. Plug in range or reconnect power.

Range Care

Clean Cycle

AquaLift® Technology is an innovative cleaning solution that utilizes heat and water to release baked-on spills from the oven in less than 1 hour. This new cleaning technology is a low-heat, odorfree alternative to traditional self-cleaning options.

Allow the oven to cool to room temperature before using the Clean cycle. If your oven cavity is above 200°F (93°C), “Oven Cooling” will appear in the display and the Clean cycle will not be activated until the oven cavity cools down.

To Clean:

1. Remove all racks and accessories from the oven cavity and wipe excess soil. Use a plastic scraper to remove easily removed soils.

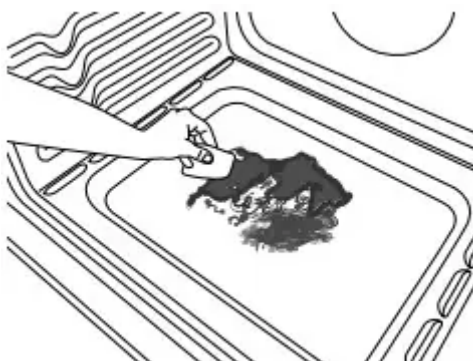

2. Pour 2 cups (16 oz [500 mL]) of distilled or filtered water onto the bottom of the empty oven and close the oven door.

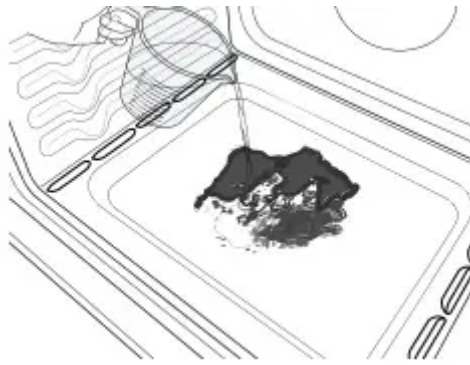

IMPORTANT: Do not use chemicals or other additives with the water. Do not open the oven door during the Clean cycle. The water on the oven bottom is hot.

3. Press AQUALIFT SELF CLEAN and then START on the oven control panel.

4. Allow 40 minutes for cleaning and cooldown. A beep will sound when the Self-Cleaning cycle is complete.

5. Press CANCEL at the end of the cycle. Cancel may be pressed at any time to stop the Clean cycle.

6. Remove the residual water and loosened soils with a sponge or cloth immediately after the Clean cycle is complete. Much of the initial 2 cups (16 oz [500 mL]) of water will remain in the oven after the cycle is completed. If additional soils remain, leave a small amount of water in the oven bottom to assist with the cleaning.

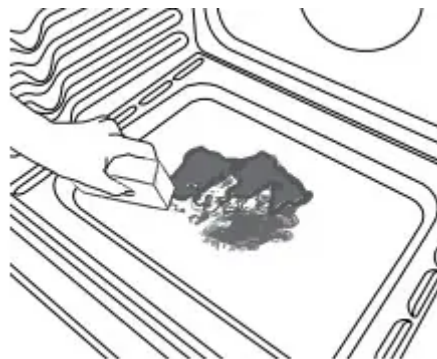

7. If any soils remain, remove them with a non-scratch scrubbing sponge or plastic scraper. Additional Clean cycles may be run to help remove the stubborn soils.

IMPORTANT: Do not use oven cleaners. The use of chemicals, including commercial oven cleaners or metal scouring pads, may cause permanent damage to the porcelain surface of the oven interior.

NOTES:

- The range should be level to ensure that the entire surface of the bottom of the oven cavity is covered by water at the beginning of the Clean cycle.
- For best results, use distilled or filtered water. Tap water may leave mineral deposits on the oven bottom.

- Before removing the residual water and loosened soils at the end of the Clean cycle, insert a cloth or paper towel between the lower edge of the oven door and the front frame to keep water from spilling onto the front of the range and the floor.
- Soil baked on through several cooking cycles will be more difficult to remove with the Clean cycle.
- Nonabrasive scrub sponges or eraser-style cleaning pads (without cleaners) can be effective for cleaning the oven cavity walls, oven door, and oven bottom for difficult soils. For best results, moisten the pads and sponges before use.
- Run an additional Clean cycle for stubborn soils.
- affresh® Kitchen Appliance Cleaner and affresh® Cooktop Cleaner may be used to clean the oven bottom, walls, and door when the oven has finished the cycle and returned to room temperature. If affresh® Cooktop Cleaner is used, it is recommended to wipe out the cavity with distilled water as well. Refer to the “Accessories” section for information on ordering.
- Additional AquaLift® Technology Cleaning Kits may be obtained by ordering Part Number W10423113RP. See the “Accessories” section for more information.

General Cleaning

IMPORTANT: Before cleaning, make sure all controls are off and the oven and cooktop are cool. Always follow label instructions on cleaning products.

EXTERIOR PORCELAIN ENAMEL SURFACES (on some models)

Food spills containing acids, such as vinegar and tomato, should be cleaned as soon as the entire range is cool. These spills may affect the finish.

Cleaning Method:

- Glass cleaner, mild liquid cleaner, or nonabrasive scrubbing pad: Gently clean around the model/serial/rating plate because scrubbing may remove numbers.
- affresh® Kitchen and Appliance Cleaner Part Number W10355010 (not included): See the “Accessories” section for more information.

STAINLESS STEEL (on some models)

NOTE: To avoid damage to stainless steel surfaces, do not use soap-filled scouring pads, abrasive cleaners, Cooktop Cleaner, steel-wool pads, gritty washcloths or abrasive paper towels. Damage may occur to stainless steel surfaces, even with one-time or limited use.

Cleaning Method:

Rub in direction of grain to avoid damaging.

- affresh® Stainless Steel Cleaner Part Number W10355016 (not included): See the “Accessories” section for more information.

METALLIC PAINT (on some models)

Do not use abrasive cleaners, cleaners with bleach, rust removers, ammonia or sodium hydroxide (lye) because paint surface may stain.

PORCELAIN-COATED GRATES AND CAPS

Food spills containing acids, such as vinegar and tomato, should be cleaned as soon as the cooktop, grates and caps are cool. These spills may affect the finish.

To avoid chipping, do not bang grates and caps against each other or hard surfaces such as cast iron cookware.

Do not reassemble caps on burners while wet.

Cleaning Method:

- Nonabrasive plastic scrubbing pad and mildly abrasive cleanser: Clean as soon as cooktop, grates and caps are cool.
- Dishwasher (grates only, not caps): Use the most aggressive cycle. Cooked-on soils should be soaked or scrubbed before going into a dishwasher. Although the burner grates are durable, they may lose their shine and/or discolor when washed in a dishwasher.
- Gas Grate and Drip Pan Cleaner Part Number 31617 (not included): See the “Accessories” section for more information.

SURFACE BURNERS

Food spills containing acids, such as vinegar and tomato, should be cleaned as soon as the cooktop, grates and caps are cool.

These spills may affect the finish.

To avoid chipping, do not bang grates and caps against each other or hard surfaces such as cast iron cookware.

Do not reassemble caps on burners while wet.

Do not clean in the Self-Cleaning cycle.

Do not clean in dishwasher.

Cleaning Method:

- Nonabrasive plastic scrubbing pad and mildly abrasive cleanser: Clean as soon as cooktop, grates, burners and caps are cool.
- Gas Grate and Drip Pan Cleaner (not included).

COOKTOP CONTROLS

To avoid damage to the cooktop controls, do not use steel wool, abrasive cleansers or oven cleaner.

To avoid damage, do not soak knobs. When replacing knobs, make sure knobs are in the Off position.

On some models, do not remove seals under knobs.

Cleaning Method:

- Soap and water: Pull knobs straight away from control panel to remove.

GRIDDLE

To avoid damaging the nonstick surface, do not use steel wool or abrasive cleaners.

Cleaning Method:

- Mild detergent
- Dishwasher: Although the griddle is durable, it may lose its shine and/or iscolor when washed in a dishwasher.

CONTROL PANEL AND OVEN DOOR EXTERIOR

To avoid damage to the control panel, do not use abrasive cleaners, steel-wool pads, gritty washcloths or abrasive paper towels.

Cleaning Method:

- Glass cleaner and soft cloth or sponge: Apply glass cleaner to soft cloth or sponge, not directly on panel.
- affresh® Kitchen and Appliance Cleaner Part Number W10355010 (not included): See the “Accessories” section for more information.

OVEN RACKS

Cleaning Method:

- Steel-wool pad
- For racks that have discolored and are harder to slide, a light coating of vegetable oil applied to the rack guides will help them slide.
- Dishwasher (steam rack water reservoir only, not racks): Although the water reservoir is durable, it may lose its shine and/or discolor when washed in a dishwasher.

DOWNDRAFT VENTILATION SYSTEM

Vent Grate

Cleaning Method:

- Remove the burner grates.
- Lift the vent grate off the cooktop



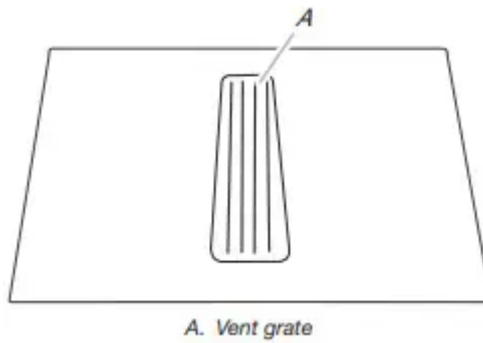

- Wipe clean or wash in sink: Nonabrasive plastic scrubbing pad and mildly abrasive cleanser
- Dishwasher: Use mild detergent.

Filter

The filter is a permanent type and should be cleaned when soiled.

Cleaning Method:

- Turn off the downdraft ventilation system before removing the filter.
- Remove vent grate, and then lift the filter out of the vent chamber.

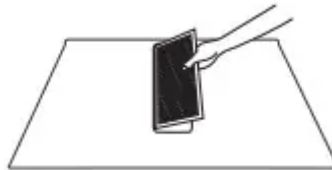

- Clean the filter in the sink with warm water and detergent or in the dishwasher.
- Replace the filter. The filter should always be placed at an angle. As you face the front of the range, the top of the filter should rest against the right side of the vent opening. The bottom of the filter should rest against the left side of the vent chamber at the bottom. If the filter is flat against the fan wall, ventilation effectiveness will be reduced.



Ventilation Chamber

The ventilation chamber, which houses the filter, should be cleaned in the event of spills or when it becomes coated with a film of grease.

Cleaning Method:

- Mild household detergent or cleanser and paper towel, damp cloth or sponge: Apply detergent or cleanser to paper towel, damp cloth or sponge, not directly to the ventilation chamber.



Troubleshooting



Problem	Possible Causes and/or Solutions
Nothing will operate	<ul style="list-style-type: none"> • Power supply cord is unplugged - Plug into a grounded outlet. • ENERGY SAVE is active, and the display is blank - Press any keypad on the control to display the time of day. See the “Electronic Oven Controls” section for more information. • Household fuse is blown or a circuit breaker is tripped - Replace the fuse or reset the circuit breaker. If the problem continues, call an electrician. • The control displays an F9 or F9 E0 error code - The electrical outlet in the home may be miswired. Contact a qualified electrician to verify the electrical supply.
Surface burners will not operate	<ul style="list-style-type: none"> • The control knob is not set correctly - Push in knob before turning to a setting. • Air in the gas lines - If this is the first time the surface burners have been used, turn on any one of the surface burner knobs to release air from the gas lines. • Clogged burner ports - See the “Sealed Surface Burners” section.
Surface burner flames are uneven, yellow and/ or noisy	<ul style="list-style-type: none"> • Clogged burner ports - See the “Sealed Surface Burners” section. • Burner caps positioned improperly - See the “Sealed Surface Burners” section. • Range converted improperly - If propane gas is being used, contact a service technician or see the “Warranty” section for contact information.
Excessive heat around cookware on cooktop	<ul style="list-style-type: none"> • Cookware and flame are not matched - The cookware should be centered above the burner with the bottom sitting level on the grate. The flame should be adjusted so that it does not extend up the sides of the pan.
Cooktop cooking results not what expected	<ul style="list-style-type: none"> • Improper cookware - Ideal cookware should have a flat bottom, straight sides and a well fitting lid, and the material should be of a medium to heavy thickness.



	<ul style="list-style-type: none"> • Control knob set to incorrect heat level - See the “Cooktop Use” section. • Range is not level - Level the range. See the Installation Instructions.
Oven will not operate	<ul style="list-style-type: none"> • Delay Start is set - See the “Cook Time” section. • Control is locked - Press and hold START for 3 seconds to unlock. • The range is in Demo mode - Demo mode will deactivate all oven elements. See “Demo Mode” in the “Electronic Oven Controls” section. • Electronic oven control set incorrectly - See the “Electronic Oven Controls” section.
Oven temperature too high or too low	<ul style="list-style-type: none"> • Oven temperature needs adjustment - See “Oven Temperature Control” in the “Electronic Oven Controls” section.
Display shows messages	<ul style="list-style-type: none"> • Power failure (display shows flashing time) - Clear the display. On some models, reset the clock, if needed. See “Clock” keypad feature in the “Feature Guide” section. • Error code (display shows letter followed by number) - Depending on your model, press CANCEL to clear the display. See “Control Display” in the “Electronic Oven Controls” section. If it reappears, call for service. See the “Warranty” section for contact information. • Start needs to be pressed so a cycle can begin (display shows “PUSH” or “PSH”) - See the “Start” keypad feature in the “Feature Guide” section. • Range is in Sabbath mode (display shows “SAb”) - Press CANCEL to exit Sabbath mode.
Clean cycle did not work on all spills	<ul style="list-style-type: none"> • Several cooking cycles between Clean cycles or spills on oven walls and doors - Run additional Clean cycles. Use the AquaLift® Technology Cleaning Kit. affresh® Kitchen and Appliance Cleaner or affresh® Cooktop Cleaner can be used for stubborn soils. See the “Accessories” and “Clean Cycle” sections for more information.



Mineral deposits are left on the oven bottom after the Clean cycle

- Tap water was used in the Clean cycle - Use distilled or filtered water in the Clean cycle. To remove deposits, use a cloth soaked with vinegar. Then use a cloth dampened with water to thoroughly remove any vinegar residue.
- Range is not level - Mineral deposits will collect on dry areas of the oven bottom during the Clean cycle. Level the range. See the Installation Instructions. To remove deposits, use a cloth soaked with vinegar. Then use a cloth dampened with water to thoroughly remove any vinegar residue.



<p>Oven cooking results not what expected</p>	<ul style="list-style-type: none"> • Range is not level - Level the range. See the Installation Instructions. • The set temperature was incorrect - Double-check the recipe in a reliable cookbook. • Oven temperature needs adjustment - See “Oven Temperature Control” in the “Electronic Oven Controls” section. • Oven was not preheated - See the “Baking and Roasting” section. • Racks were positioned improperly - See the “Positioning Racks and Bakeware” section. • Not enough air circulation around bakeware - See the “Positioning Racks and Bakeware” section. • Darker browning of food caused by dull or dark bakeware - Lower oven temperature 25°F (15°C) or move rack to a higher position in the oven. • Lighter browning of food caused by shiny or light colored bakeware - Move rack to a lower position in the oven. • Batter distributed unevenly in pan - Check that batter is level in the pan. • Incorrect length of cooking time was used - Adjust cooking time. • Oven door was not closed - Be sure that the bakeware does not keep the door from closing. • Oven door was opened during cooking - Oven peeking releases oven heat and can result in longer cooking times. • Rack is too close to bake burner, making baked items too brown on bottom - Move rack to higher position in the oven. • Pie crusts browning too quickly - Use aluminum foil to cover the edge of the crust and/or reduce baking temperature.
<p>Ventilation system not capturing smoke efficiently</p>	<ul style="list-style-type: none"> • Poor cross ventilation in the room or makeup air - See the Installation Instructions. • Outside wall cup shut or blocked - Check outside wall cup. • Range or air filter installed incorrectly - See the Installation Instructions
<p>Noises</p>	



Surface burner making popping noises	Wet burner - Allow it to dry
---	------------------------------

Warning

This content is compiled from multiple sources and is provided for reference purposes only. It may not be complete or fully applicable to all situations. If you are unable to resolve your issue, please contact the product manufacturer or an authorized service provider for official support.

