

Before using for the first time

Opening the door

At the end of programs with a drying phase (see “Program overview”) the door will open automatically a little in order to help the drying process. This function can be deactivated, if preferred (see “Programming options, AutoOpen”).

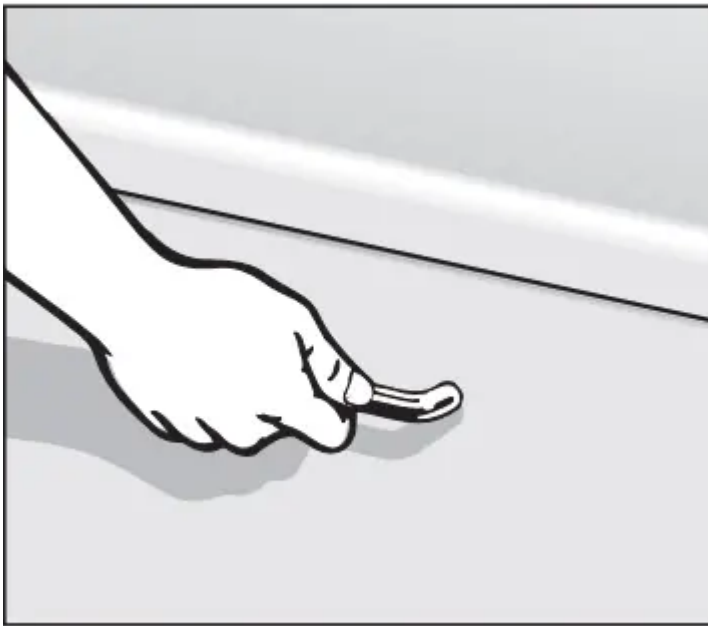

- Pull the handle to open the door.
- Open the door fully so that the door locking pins retract again.

If the door is opened during operation, all functions are automatically interrupted.



Water in the dishwasher may be hot. Danger of scalding!

Only open the door during operation if absolutely necessary and exercise extreme caution when doing so.



Keep the area around the door free of obstructions.

Closing the door

- Push the baskets in.
- Then lift the door upwards and push until it clicks into position.



Danger of crushing injuries!

Do not put your hand inside the door as it is closing.

Water softener

In order to achieve good cleaning results, the dishwasher needs to operate with soft water. Hard water results in a build-up of calcium deposits on dishware and in the dishwasher.

Water supplies with a hardness level higher than 4 gr/gal (4 °d) needs to be softened. This takes place automatically in the integrated water softener. The water softener in the dishwasher is suitable for a water hardness level of up to 73 gr/gal (70 °d).

- The water softener requires dishwasher salt. Depending on the water hardness level (< 22 gr/gal, or 21 °d), dishwasher salt is not required if combination tablets are being used (see “Operation - Detergent”).
- The dishwasher must be programmed for the water hardness in your area.
- Your local water supplier can tell you the water hardness level in your area.
- Where the water hardness fluctuates e.g. between 10 - 16 gr/gal (10 - 15 °d), always program the dishwasher to the higher value (16 gr/gal or 15 °d in this example).

It is useful to know your water hardness so that you can provide the service technician with this information in the event of any service calls.

Enter the water hardness below: _____ gr/gal (°d)

The dishwasher is programmed at the factory for a water hardness level of 1 gr/gal (1 °d).

If this setting corresponds to the hardness of your water, you do not need to do anything more.

However, if you have a different water hardness, you must adjust the water softener to match your water hardness.

Rinse aid

Rinse aid is needed to prevent spotting on dishes and glassware. The rinse aid is filled in the reservoir and the set amount will be automatically dosed.



Filling the rinse aid reservoir with detergent will damage the reservoir. Only pour rinse aid formulated for residential dishwashers into the reservoir.

When using “Tab” detergents rinse aid is not needed.

Adding rinse aid

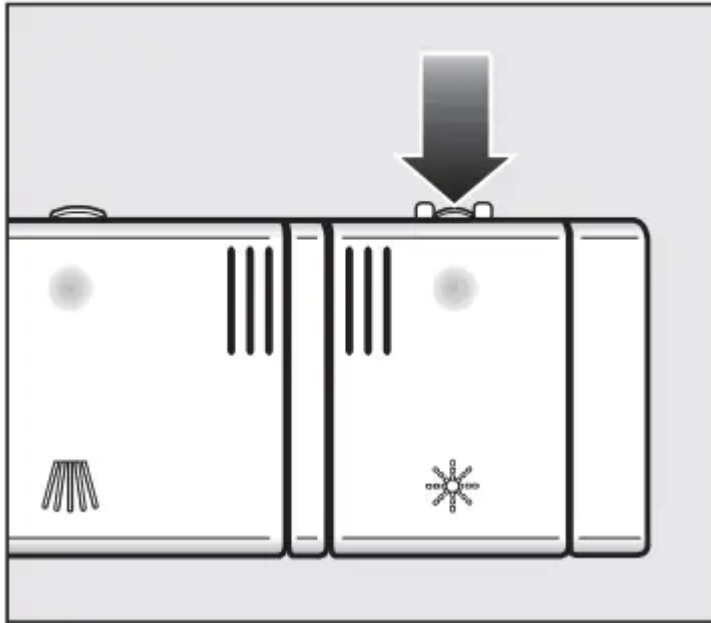

- Press the button on the lid of the rinse aid reservoir in the direction of the arrow until the flap springs open.

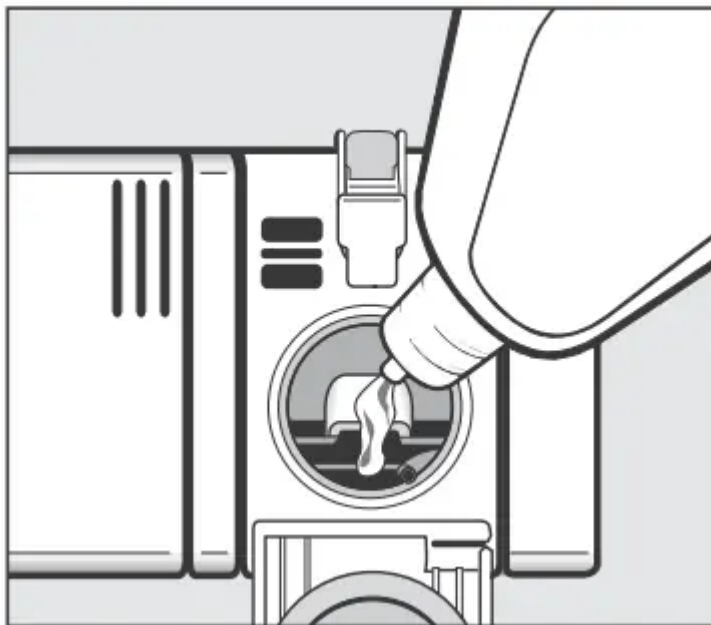

- Add rinse aid only until it is visible in the opening.

The rinse aid reservoir holds approx. 3.7 oz. (110 ml).

- Close the flap firmly so that it clicks into place. Otherwise water can enter the rinse aid reservoir during a program.
- Wipe up any spilled rinse aid. This prevents over-foaming occurring during the next program.

Loading the dishwasher

Tips

Remove coarse food residues from the dishes.

There is no need to rinse items under running water!



Do not wash items soiled with ash, sand, wax, grease, or paint in the dishwasher. These will damage the dishwasher.

Dishes can be loaded anywhere in the baskets, but the following notes should be observed:

- Do not place dishes or cutlery inside other pieces. They will cover each other.
- Load the dishes so that water can access all surfaces. This ensures that they get properly cleaned.
- Make sure that all items are securely positioned.
- Hollow items such as cups, glasses, pans, etc. must be inverted in the basket.
- Tall, narrow, hollow items, e.g., champagne glasses, should be placed in the center of the basket to ensure better water coverage.
- Concave items such as mugs or bowls should be placed at an angle so that the water can run off.
- The spray arms must not be blocked by items which are too tall or hang through the baskets. If in doubt, test for free movement by manually rotating the spray arms.
- Make sure that small items cannot fall through the holders in the baskets.
- Small items, e.g., lids, should therefore be placed in the cutlery tray or cutlery basket (depending on model).

Some foods may contain natural dyes, e.g., carrots, tomatoes or tomato sauce. Plastic items in the dishwasher may discolor if large quantities of these foodstuffs find their way into the dishwasher on the dishes. The stability of plastic items is not affected by this discoloration. Cleaning silver cutlery in the dishwasher may also cause plastic items to discolor.

Loading examples

Loading for 10 standard place settings with cutlery tray

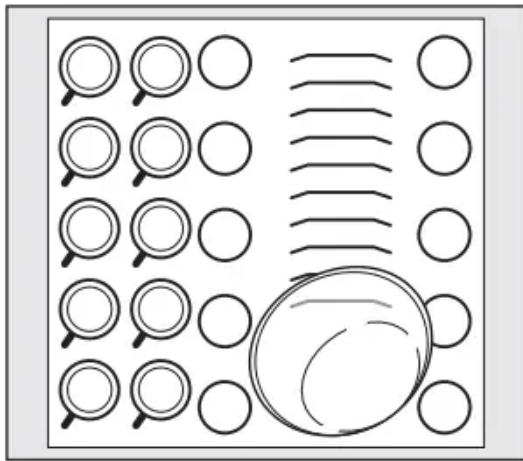

Upper basket



Lower basket

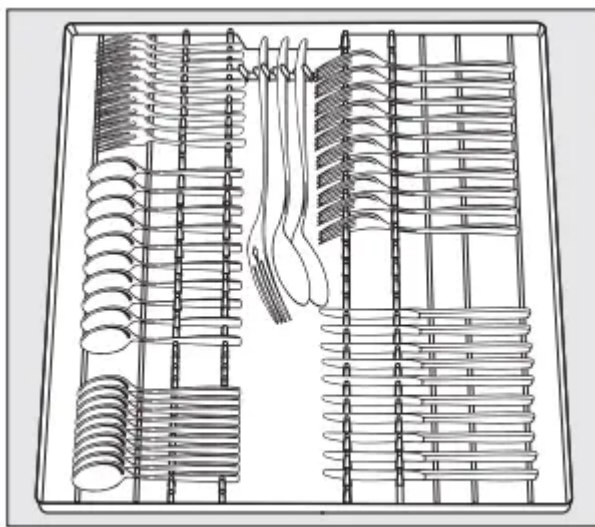

Cutlery tray (depending on model)

Loading for 16 standard place settings with cutlery tray

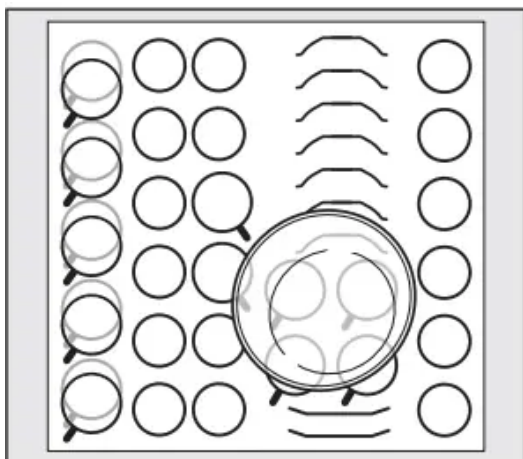

Upper basket

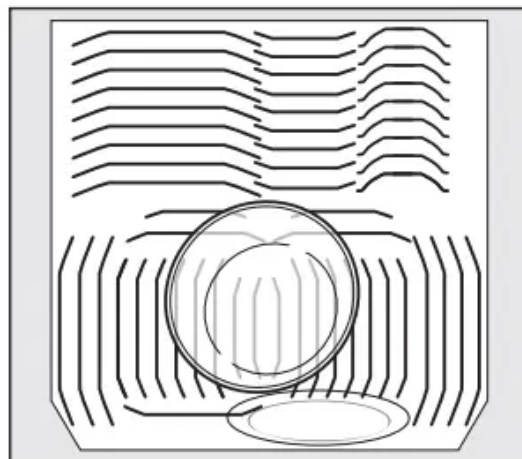

Lower basket



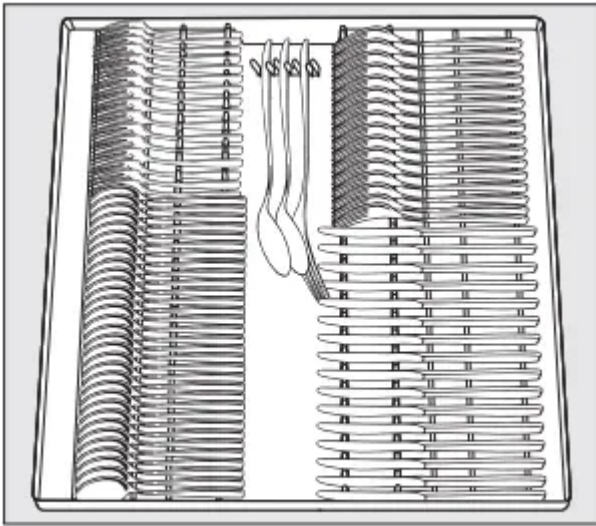

Cutlery tray (depending on model)

Loading for 10 standard place settings with cutlery basket

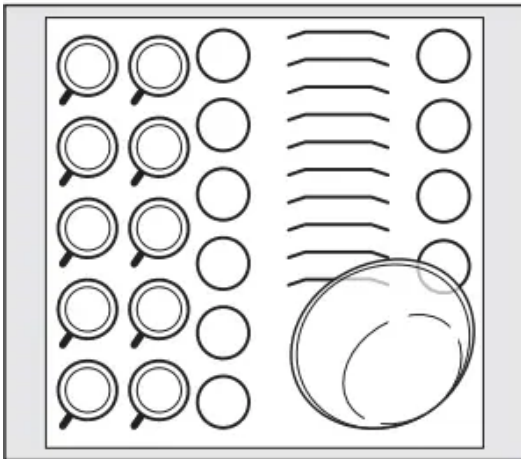

Upper basket

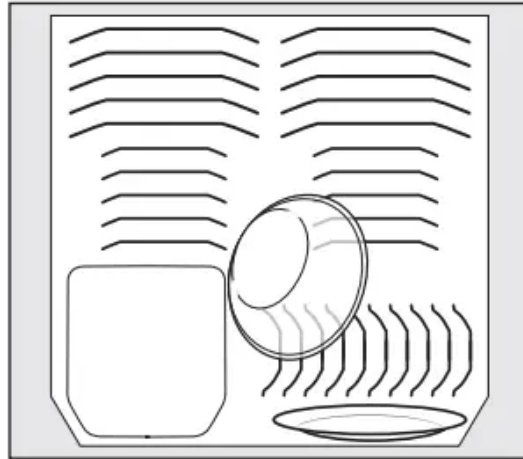

Lower basket

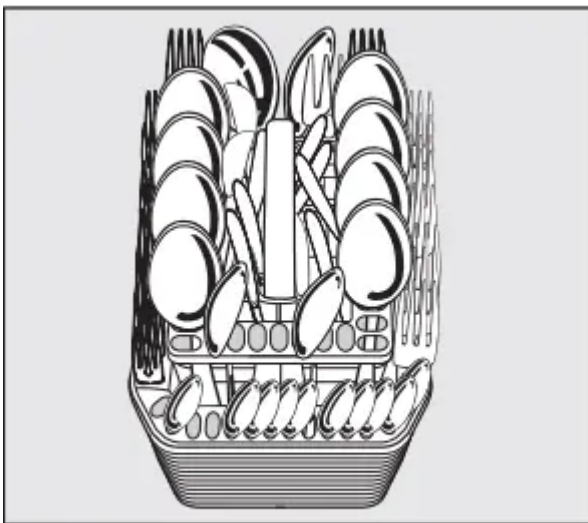

Cutlery basket

Loading for 13 standard place settings with cutlery basket



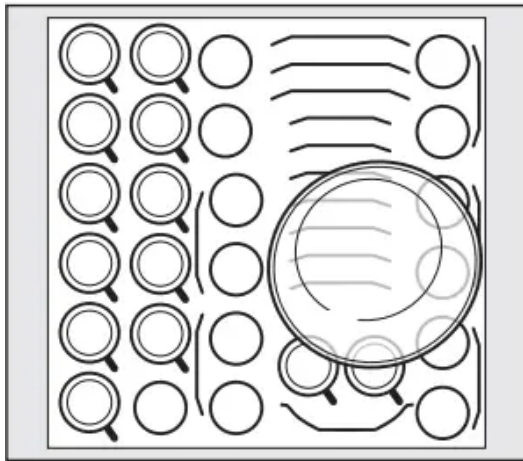

Upper basket

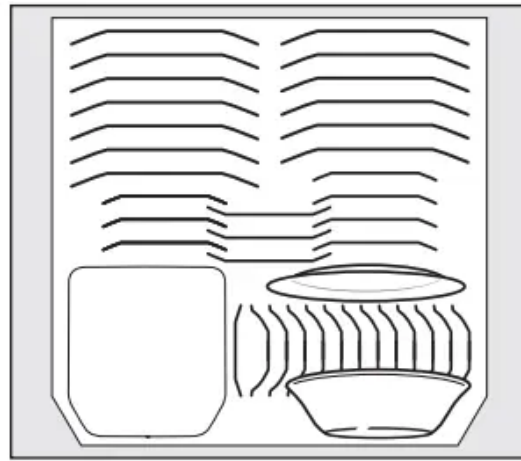

Lower basket

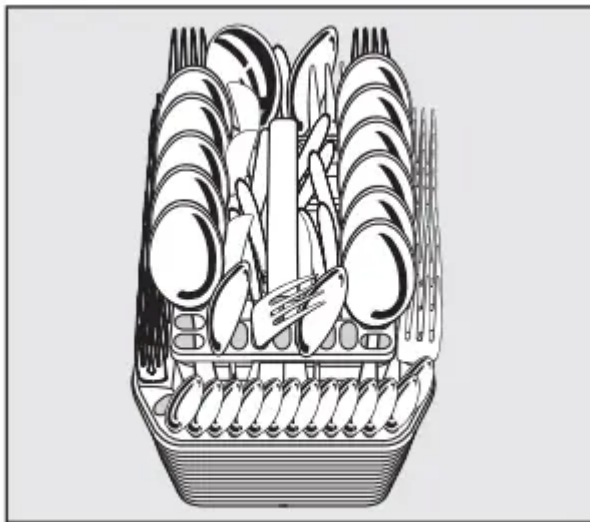

Cutlery basket

Operation

Adding detergent

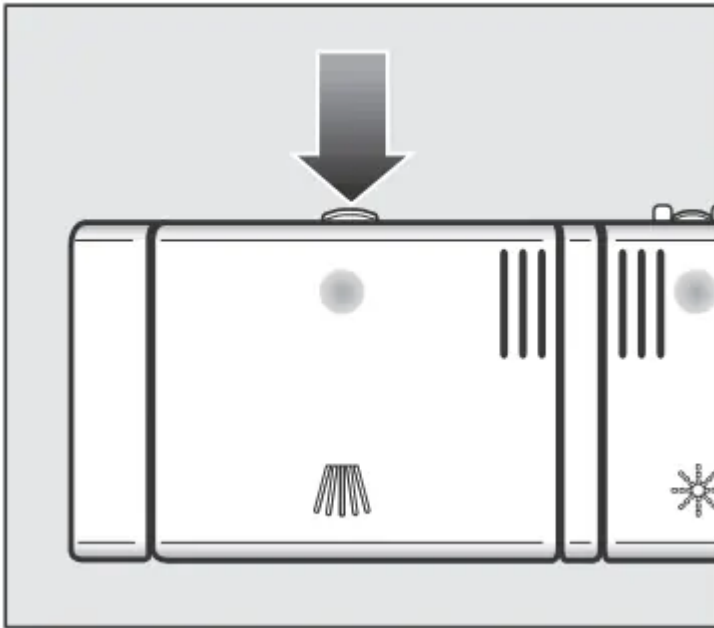

- Press the opening catch on the detergent dispenser. The flap will spring open.

The flap is always open at the end of a program.

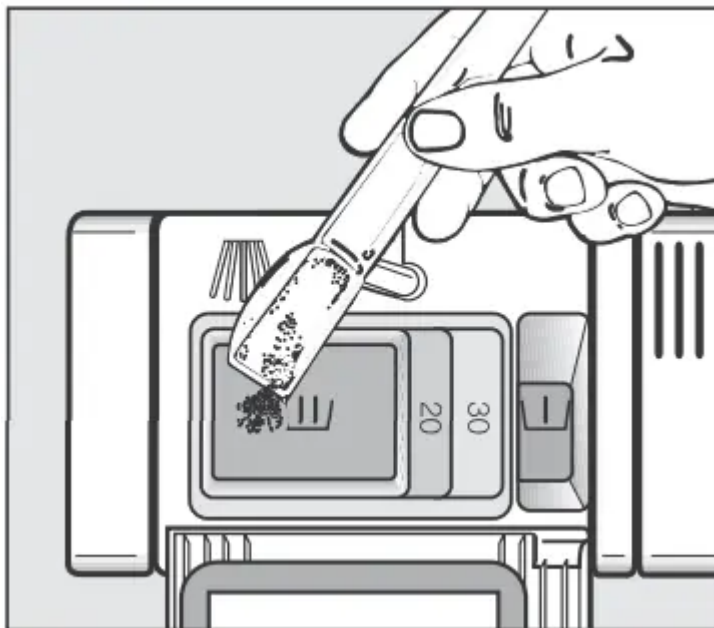

- Add the required amount of detergent and close the flap.
- Make sure that the detergent packaging is properly closed after use to avoid it getting damp and becoming lumpy.

Dispensing aid

Compartment I holds a maximum of 2 teaspoons (10 ml),

Compartment II holds a maximum of 3 ½ tablespoons (50 ml) of detergent.

The marks in compartment II indicate the levels of approximately 1 ¼ and 2 tablespoons (20 and 30 ml) respectively. The marks indicate the approximate fill level in ml when the door is open in a horizontal position.

Turning on

- Turn on the water supply if it is turned off.
- Open the door.
- Make sure the spray arms are not obstructed.
- Turn the dishwasher on with the  button.

The indicator light next to the program selected will come on.

Selecting a program

Choose your program according to the type of load and the degree of soiling.

The different programs and their uses are described in the Program Overview chapter.

- Use the program selection button  to select the program required.

The indicator light for the program selected will light up.

The program duration will appear in hours and minutes in the display.

You can now select program options (see “Options”).

If any program options are selected, the appropriate indicator lights will also light up.

Starting a program

- Start the program by closing the door within four seconds of the last press of a button.

The program will begin.

The Optical Interface comes on to show that a program has been started.

If you do not close the door within four seconds, the indicator light of the selected program and the time display will flash.

The program cannot be started until you press the program selection button and close the door within four seconds.

A program should only be canceled in the first few minutes, if at all. Otherwise important program stages could be omitted.

Time display

The duration of the program selected appears in hours and minutes in the display before the program begins. During the program, the time left until the end of the program can only be viewed when the door is open.

The program duration displayed may vary with the same program. It is influenced by, among other things, the water temperature at each intake, the reactivation process, the softener assembly, the type of detergent, the amount of dishes, and the amount of soiling.

When a program is selected for the first time, the display will show the average program duration for a cold water intake.

The times shown in the program overview refer to standard test loads and temperatures.

Each time a program is run, the electronic module calculates the program duration required depending on the temperature of the water taken into the dishwasher and the amount of dishes.

Energy management

To save energy, the dishwasher will switch off automatically 10 minutes after the last time a button has been pressed or 10 minutes after the end of the program (see “Options, Optimize Standby”).

- Press the  button to switch the dishwasher back on.

The dishwasher will not turn off while a program is running, during the delay start period, or if there is a fault.

At the end of the program

At the end of a program, the In-operation indicator light will be visible flashing slowly with the door shut. The buzzer might also be sounding.

The In-operation indicator light or time display will go out 10 minutes after the program has finished.

During the drying phase, the door may open slightly and briefly show how long the program still has to run. The time display will then go out and the indicator light  will start to flash.

Press any button to see how long the program still has to run.

Once the program has ended, **0.00** appears in the time display.

In the QuickIntenseWash program, the door will not open until a few minutes after the program has finished.

The drying fan may continue to run for a few minutes at the end of the program.

- Open the door fully so that the door locking pins retract again.

You can now empty the dishwasher.

 If you have deactivated the automatic door opening function (see “Programming options, AutoOpen”), and would like to open the door as soon as the program has finished, make sure that you open the door fully.

Otherwise steam from the dishwasher could damage the edge of the counter because the fan is no longer running.

Turning off the dishwasher

Turning off the dishwasher

- At the end of a program:
- Open the door.

The dishwasher can be switched off at any time using the  button.

Switching the dishwasher off during a program stops the program.

Turning the dishwasher off during the run-up to a delay start time (FlexiTimer) will also stop the process.

If the dishwasher is not going to be used for a longer period of time, e.g., while on vacation, the water supply should be turned off.

Unloading the dishwasher

Dishes tend to break and chip more easily when they are hot. Allow the dishes to cool until they are comfortable enough to handle before unloading them.

The dishes will cool much faster if you open the door when the program has ended.

First unload the lower basket, then the upper basket, and finally the cutlery tray (depending on model).

This will prevent water drops from the upper basket and cutlery tray from falling onto the dishes in the lower basket.

Interrupting a program

The program will be interrupted as soon as you open the door.

After four seconds, the indicator light of the selected program and the time display will flash.

- Press the program selection button and close the door within four seconds.

The program will continue from the point at which it was interrupted.



 Water in the dishwasher may be hot. Danger of scalding!

Only open the door if absolutely necessary and exercise extreme caution when doing so. Before closing the door again, leave it ajar for approx. 20 seconds. This will enable the temperature in the wash cabinet to settle. After that, press the program selection button and close the door within four seconds.

Changing a program

If the detergent dispenser flap has already opened, do not change the program.

If a program has already started and you wish to change it, proceed as follows:

- Open the door.
- Turn the dishwasher off with the  button.
- Turn the dishwasher on again with the  button.
- Select the desired program.
- Start the program by closing the door within four seconds.

The Optical Interface comes on to show that a program has been started.



Options

Short

The “Short”  option reduces the duration of programs in which this option is available (see “Program overview”).

In order to achieve optimum cleaning results, consumption rates are increased with this option.

When used in combination with the “QuickIntenseWash” program, the Short  option results in a rinse cycle without drying or automatic opening of the door (if available).

- Open the door.
- Turn the dishwasher on with the  button.
- Select a program.
- Press the  button.





The  indicator light will light up.

- The program can now be started.

The option selected will remain active for that particular program until the setting is changed.

Turning off the refill indicators

If you consistently use a Tab detergent, you can deactivate the refill indicators if you wish.

- Open the door.
- Turn the dishwasher off with the  button, if it is turned on.
- Press the program selection button  and, simultaneously switch the dishwasher on using the  button. Keep the program selection button  pressed in for at least four seconds until the lower right program indicator light comes on.

If this does not happen, start the procedure from the beginning again.

- Press the  button 9 times.

The  indicator light will flash 9 times at short intervals.

The flashing sequence in the time display will show whether the refill indicators are switched on or off.

- **P1** : Refill indicators activated
- **P0** : Refill indicators deactivated
- Press the program selection button  to change the setting.

The setting is now stored in memory.

- Turn the dishwasher off with the  button.

If you switch to using detergent that does not contain salt or rinse aid, it is important to remember to add dishwasher salt and rinse aid and to switch the indicators back on.

Delay Start

You can set the start time for a program, e.g., to take advantage of night time electricity rates. The start time can be delayed between 30 minutes and 24 hours.

The delay period is shown in 30 minutes increments for a delay period between 30 minutes and 9 hours 30 minutes. It is shown in hours for periods longer than this.

When using the Delay Start function, make sure that the detergent compartment is dry before adding detergent. Wipe dry with a cloth if necessary. If the compartment is wet, powder detergent can become lumpy and stick to the dispenser, with the result that it is not fully dispensed.



Do not use liquid detergent when selecting Delay Start, as it can run into the dishwasher before it is required.

- Open the door.
- Turn the dishwasher on with the  button.
- Select the desired program.

- Press the  button.

The last delay start time used will appear in the time display. The  indicator light will light up.

- Set the required delay start time using the  button.

If you keep the  button pressed, the time will increase automatically up to **24** hours. To get back to **0.30** hours, press the  button twice.

- Close the door within four seconds.

If you do not close the door within four seconds, the indicator light of the selected program and the time display will flash.

The program cannot be started until you press the program selection button and close the door within four seconds.

- Open the door if you need to check how long the delay period has left to run.

The time up until the program starts will count down in the display in hours for durations above 10 hours, and in minutes for durations below 10 hours.

When the set time is reached, the program selected will start automatically. The time remaining will appear in the time display and the  indicator light will go out.

How the Delay Start time is shown in the display:

up to 59 minutes:

e.g., 30 minutes = **0.30**



1 hour up to 9 hours 30 minutes:

e.g., 5 hours = **5.00**

over 10 hours: e.g., 15 hours = **15**

If you open the door during the delay start time, you must then press the program selection button and close the door within four seconds in order to continue the delay start time.

A program can be started before the delay start period has elapsed. Proceed as follows:

- Open the door.
- Turn the dishwasher off with the  button.
- Turn the dishwasher on again with the  button.
- Select the program you want.
- Start the program by closing the door within four seconds.

The Optical Interface comes on to show that a program has been started.





If you do not close the door within four seconds, the indicator light of the selected program and the time display will flash.

The program cannot be started until you press the program selection button and close the door within four seconds.

AutoOpen

At the end of programs with a drying phase (see “Program overview”), the door will open automatically a little in order to help the drying process.

This function can be deactivated if wished.

- Open the door.
- Turn the dishwasher off with the  button, if it is turned on.
- Press the program selection button  and simultaneously switch the dishwasher on using the  button. Keep the program selection button  pressed in for at least four seconds until the lower right program indicator light comes on.

If this does not happen, start the procedure from the beginning again.

Press the  button seven times.

The  indicator light will flash briefly seven times at short intervals.

The flash pattern in the time display indicates whether the “AutoOpen” function is activated or not:

– *P 1*: “AutoOpen” activated

– *P 0*: “AutoOpen” is deactivated

- Press the program selection button  to change the setting.

The setting is now saved.

- Turn the dishwasher off with the  button. 

 If you have deactivated the automatic door opening function and would like to open the door as soon as the program has finished, make sure that you open the door fully. Otherwise steam from the dishwasher could damage the edge of the counter because the fan is no longer running.

Cleaning and care

Cleaning the wash cabinet

Generally, the wash cabinet is self cleaning if the correct amount of detergent is used.

If, however, there are limescale or grease deposits in the wash cabinet, these can be removed with a special cleaning agent (available from Miele). Follow the instructions on the packaging.

If you mainly use low temperature programs (< 120°F/50 °C), there is a risk of bacteria and unpleasant odors building up in the wash cabinet. To prevent this happening the dishwasher will automatically increase the temperature in the final rinse of the selected program after several programs using low temperatures have been run.

- Clean the filters in the wash cabinet regularly

Cleaning the door and the door seal

Bacteria could build up on the door seal and the sides of the dishwasher door as these surfaces are outside the wash cabinet and are not accessed and cleaned by the spray arm jets.

- Wipe the door seals regularly with a damp cloth to remove food deposits.
- Wipe off any food or drink residues which may have dripped onto the sides of the dishwasher door before closing it.

Cleaning the control panel

- The control panel should only be wiped with a damp cloth.

Cleaning the indicator reflector panel

The indicator reflector panel for the Optical Interface / TimeControl function (depending on model) is situated in the cover plate underneath the counter.

- The indicator reflector panel should only be wiped with a damp cloth or a suitable cleaning agent designed for use on plastic.

Cleaning the door front



If soiling remains longer, it may happen that the surfaces can become discolored or changed. Remove any soiling immediately.

- Clean the front with a solution of warm water and a little dishwashing liquid applied with a soft sponge. Wipe the surfaces dry using a soft cloth.



Glass cleaners may be used to clean the exterior. However do not allow them to sit or “puddle”, this can cause damage to the surface. Remove the cleaner promptly.

Filter system

The filter system in the base of the wash cabinet prevents food from being redeposited on dishes. It also protects the circulation pump from damage caused by foreign objects.



This dishwasher must not be used without all the filters in place!

Collection of coarse soil may cause the filters to clog. The level of soiling and time it takes before the filters need cleaning will vary depending on use.

- Check the condition of the filters regularly and clean them if necessary

Filter system

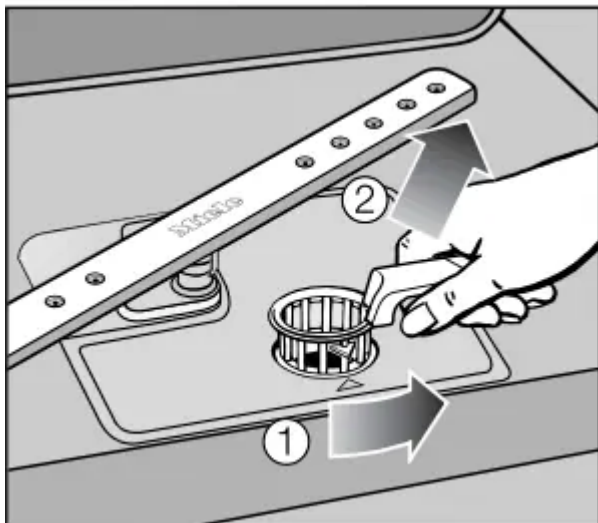

- Turn the handle counter-clockwise to release the filter system ①.
- Lift the filter system out of the dishwasher ②. Remove any coarse particles and rinse the filter well under running water.

Use a nylon brush if necessary.

⚠ Ensure that coarse soil does not get into the circulation system and cause a blockage.

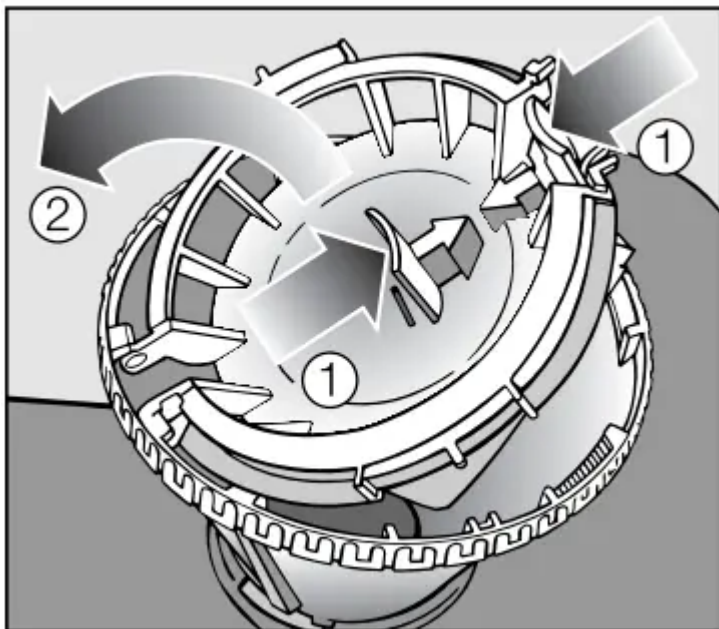

To clean the inside of the filter, the flap must be opened:

- Press catches ① together in the direction of the arrows as shown, and open the filter ②.

- Rinse all the filters under running water.
- Then close the flap so that the catch engages.

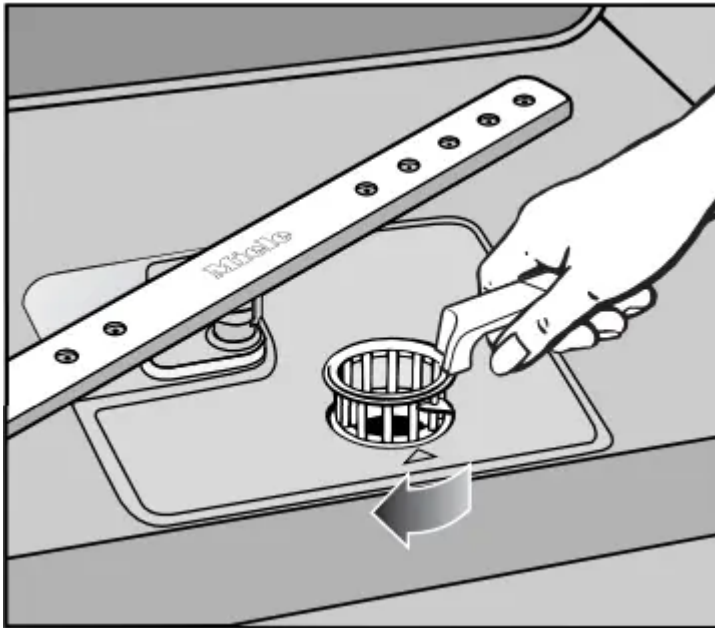

- Replace the filter system so that it lies flat in the base of the wash cabinet.
- Then turn the handle clockwise until both arrows point towards each other. This will lock the filter system in place.

 Take care when you are fitting the filter system that it is secured in position correctly.

Otherwise coarse soil could get into the circulation system and cause a blockage.

Cleaning the spray arms

Particles of food can get stuck in the spray arm jets and bearings. The spray arms should therefore be inspected and cleaned regularly (approx. every 4 - 6 months).

- Turn the dishwasher off.

Remove the spray arms as follows:

- Take out the cutlery tray (if your dishwasher is fitted with one).
- Push the top spray arm upwards to engage the inner ratchet. Then unscrew the spray arm.

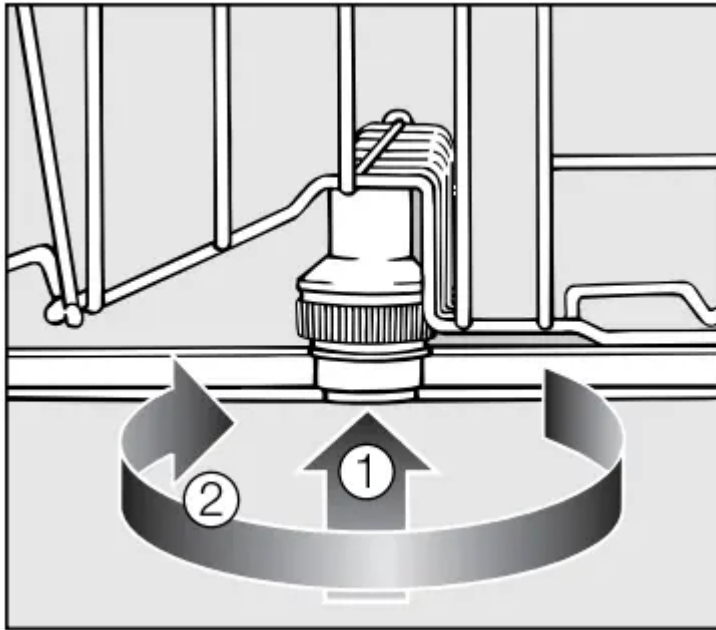

- Push the middle spray arm upwards **1** to engage the ratchet. Then unscrew the spray arm **2**.
- Remove the lower basket.

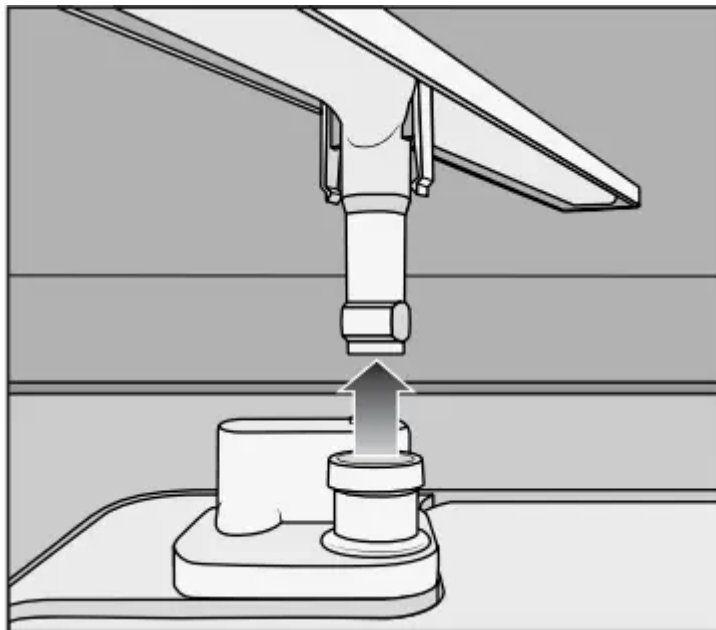

- Pull the lower spray arm firmly upwards to remove it.

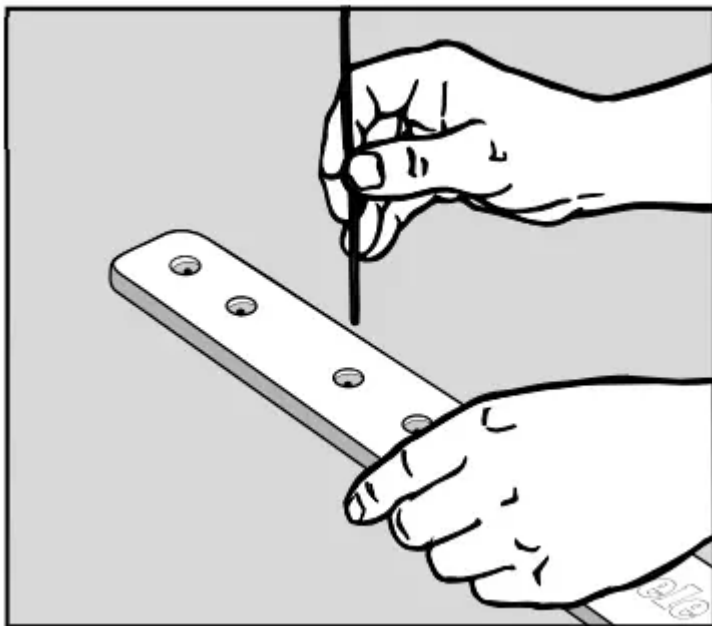

- Use a pointed object to push the food particles that are stuck in the spray arm jets into the spray arm.
- Rinse the spray arms thoroughly under running water.
- Replace the spray arms and check that they rotate freely

Frequently Asked Questions

With the help of the following guide, minor faults in the performance of the appliance, some of which may result from incorrect operation, can be put right without contacting Miele Service. This will save time and money.

The following guide may help you to find the reason for a fault, and to correct it. You should, however, note the following:

 Unauthorized or incorrect repairs could cause personal injury or damage to the appliance.

Repair work to electrical appliances must only be carried out by a suitably qualified and competent person in strict accordance with current local and national safety regulations. The manufacturer cannot be held liable for unauthorized work.

Technical problems	
Problem	Possible cause and solution
The dishwasher does not start.	The door is not properly closed. <ul style="list-style-type: none"> ■ Push the door firmly shut.
	The dishwasher is not plugged in. <ul style="list-style-type: none"> ■ Insert the plug.
	The circuit breaker has tripped. <ul style="list-style-type: none"> ■ Reset the fuse (see data plate for the correct fuse rating).
	The dishwasher is not switched on. <ul style="list-style-type: none"> ■ Turn the dishwasher on with the  button.
The dishwasher stops during a program.	The circuit breaker has tripped. <ul style="list-style-type: none"> ■ Reset the fuse (see data plate for the correct fuse rating). ■ If the circuit breaker trips again, contact Miele Service.
After the program has started, the Optical Interface is not visible.	The indicator reflector panel was not correctly fitted. <ul style="list-style-type: none"> ■ Refit the indicator reflector panel correctly (see the installation plan).
The buzzer is sounding. The program will not start. The In-operation indicator light is not lit up.	The door has not closed properly, because it had not been fully opened after the door had been opened automatically. <ul style="list-style-type: none"> ■ Open the door fully so that the door locking pins retract again. ■ Then close the door.

Problem	Possible cause and solution
<p>The Optical Interface is flashing quickly.</p> <p>The buzzer is sounding. All the program indicator lights flash when the door is open.</p> <p>Fault code FXX appears in the display.</p>	<p>There may be a technical fault.</p> <ul style="list-style-type: none"> ■ Turn the dishwasher off with the ⓘ button. ■ Turn the dishwasher back on after a few seconds. ■ Select the desired program. ■ Close the door. <p>If the indicator lights flash again, there is a technical fault.</p> <ul style="list-style-type: none"> ■ Contact Miele Service.
<p>Fault F70:</p> <p>The buzzer is sounding continuously.</p> <p>The drain pump may also be running, even with the door open.</p>	<p>The WaterProof System has reacted.</p> <ul style="list-style-type: none"> ■ Turn off the water supply. ■ Contact Miele Service.
<p>Fault F78:</p>	<p>A fault has occurred in the circulation pump.</p> <ul style="list-style-type: none"> ■ Turn the dishwasher off for at least 30 seconds with the ⓘ button. ■ Turn the dishwasher back on. ■ Select the desired program. ■ Close the door. <p>If the fault message appears again, there is a technical fault.</p> <ul style="list-style-type: none"> ■ Contact Miele Service.

Water intake fault	
Problem	Possible cause and solution
<p>The In-operation indicator light is flashing quickly.</p> <p>The buzzer is sounding. The <i>Intake/ Drain</i> indicator light is flashing on and off.</p>	<p>The water supply is turned off.</p> <ul style="list-style-type: none"> ■ Turn on the water supply fully.
<p>The In-operation indicator light is flashing quickly.</p> <p>The buzzer is sounding. The <i>Intake/ Drain</i> indicator light is flashing.</p> <p>The fault code <i>F12</i> or <i>F13</i> has appeared in the display.</p>	<p>Before fixing the fault:</p> <ul style="list-style-type: none"> ■ Turn the dishwasher off with the  button. <p>There is a problem with the water intake.</p> <ul style="list-style-type: none"> ■ Turn on the water supply fully and start the program again. ■ Clean the water intake filter (see “Frequently asked questions”). ■ The flow pressure at the connection point is lower than 7.25 psi. <p>Contact a plumber.</p>

Water drainage fault

Problem	Possible cause and solution
<p>The Optical Interface is flashing quickly.</p> <p>The buzzer is sounding. The <i>Intake/Drain</i> indicator light is flashing and fault code F11 has appeared in the display.</p>	<p>Before fixing the fault:</p> <ul style="list-style-type: none"> ■ Turn the dishwasher off with the ⓘ button. <hr/> <p>There is a problem with the water intake.</p> <p>There might be water in the wash cabinet.</p> <ul style="list-style-type: none"> ■ Clean the filter system (see “Cleaning and care -Filter system”). ■ Clean the drain pump (see “Frequently asked questions”). ■ Clean the non-return valve (see “Frequently asked questions”). ■ Remove any kink or loop in the drain hose.

General problems

Problem	Possible cause and solution
<p>The Optical Interface is flashing quickly.</p> <p>The warning buzzer is sounding.</p> <p>The indicator light of the selected program and the time display flash.</p> <p>The dishwasher does not start or the delay start time stops running.</p>	<p>The safe mode of the dishwasher was activated.</p> <p>The following takes place:</p> <ul style="list-style-type: none"> - If you do not close the door within four seconds of the last press of a button at program start - If the door is open for longer than four seconds during a program or within the delay start time. <p>■ Press the program selection button and close the door within four seconds.</p>
<p>Detergent residue is left in the dispenser at the end of a program.</p>	<p>The dispenser was still damp when detergent was added.</p> <p>■ Make sure the dispenser is dry before adding detergent.</p>
<p>The dispenser cover cannot be closed.</p>	<p>Detergent residue is blocking the latch. ■ Remove the detergent residue.</p>
<p>The inside of the door and/or the interior walls are wet after a program has finished.</p>	<p>This is caused by the drying system and does not indicate a fault. The moisture will dissipate after a while.</p>
<p>Water remains in the wash cabinet at the end of a program.</p>	<p>Before fixing the fault:</p> <p>■ Turn the dishwasher off with the  button.</p>
	<p>The filter system in the wash cabinet is clogged.</p> <p>■ Clean the filter system (see “Cleaning and care -Filter system”).</p>
	<p>The drain pump or non-return valve is blocked.</p> <p>■ Clean the drain pump or the non-return valve (see “Frequently asked questions”).</p>
	<p>The drain hose is kinked.</p>

- Remove the kink.

Noises

Problem	Possible cause and solution
<p>There is a knocking noise in the wash cabinet.</p>	<p>A spray arm is hitting the dishes.</p> <ul style="list-style-type: none"> ■ Interrupt the program, and rearrange the items which are obstructing the spray arm.
<p>There is a rattling noise in the wash cabinet.</p>	<p>Dishes is moving around in the wash cabinet.</p> <ul style="list-style-type: none"> ■ Interrupt the program and rearrange loose pieces.
	<p>A foreign object (e.g., a cherry pit) has become lodged in the drain pump.</p> <ul style="list-style-type: none"> ■ Remove the foreign object from the drain pump (see “Maintenance - Cleaning the drain pump and non-return valve”).
<p>There is a knocking noise from the water pipe</p>	<p>This may be caused by the installation or the diameter of the water pipe.</p> <ul style="list-style-type: none"> ■ This has no influence on dishwasher function. If in doubt, contact a suitably qualified plumber.

Poor cleaning results

Problem	Possible cause and solution
<p>The dishes are not clean.</p>	<p>The dishes were not loaded correctly.</p> <ul style="list-style-type: none"> ■ See notes in “Loading the dishwasher”.
	<p>The program was not powerful enough.</p> <ul style="list-style-type: none"> ■ Select a more intensive program (see “Program overview”).
	<p>Not enough detergent was dispensed.</p> <ul style="list-style-type: none"> ■ Use more detergent, or change your detergent.
	<p>Items are blocking the path of the spray arms.</p> <ul style="list-style-type: none"> ■ Rearrange the items so that the spray arms can rotate freely.
	<p>The filter system in the base of the wash cabinet is not clean or is not correctly fitted.</p> <p>This may cause the spray arm jets to get blocked.</p> <ul style="list-style-type: none"> ■ Clean and/or fit the filter system correctly. ■ Clean the spray arm jets if necessary (see “Cleaning and care - Cleaning the spray arms”).
	<p>The non-return valve is open and blocked. Dirty water has flowed back into the wash cabinet.</p> <ul style="list-style-type: none"> ■ Clean the drain pump and the non-return valve (see “Frequently asked questions”).
<p>Smearing appears on glassware and cutlery. There is a bluish sheen on the surface of glassware; film can be wiped off.</p>	<p>The rinse aid dosage is set too high.</p> <ul style="list-style-type: none"> ■ Decrease the dosage (see “Before using for the first time - Rinse aid”).

Frequently Asked Questions



Problem	Possible cause and solution
<p>Dishes is not dry or cutlery and glasses are spotty.</p>	<p>The rinse aid dosage is set too low or the rinse aid reservoir is empty.</p> <ul style="list-style-type: none"> ■ Replenish the reservoir, increase the dosage, or change the brand of rinse aid (see “Before using for the first time - Rinse aid”). Dishes was taken out of the cabinet too soon. ■ Leave it in for longer (see “Operation”). Combination tabs have been used which have impaired drying performance. ■ Change your detergent, or replenish the rinse aid (see “Before using for the first time - Rinse aid”).
<p>Glasses have a brownish-blue discoloration; the deposit cannot be wiped off.</p>	<p>Detergent deposits.</p> <ul style="list-style-type: none"> ■ Switch to another detergent.
<p>Glasses are dull and discolored; the deposit cannot be wiped off.</p>	<p>The glassware is not dishwasher-safe. The surfaces are affected.</p> <ul style="list-style-type: none"> ■ There is no remedy. <p>Purchase glassware which is dishwasher-safe.</p>
<p>Tea or lipstick stains have not been completely removed.</p>	<p>The wash temperature of the selected program was too low.</p> <ul style="list-style-type: none"> ■ Select a program with a higher wash temperature. The bleaching effect of the detergent is too low. ■ Switch to another detergent.
<p>Plastic parts are discolored.</p>	<p>Natural dyes, e.g., from carrots, tomatoes, or ketchup may be the cause. The amount of detergent used or its bleaching effect was not sufficient to deal with natural dyes.</p> <ul style="list-style-type: none"> ■ Use more detergent (see “Operation - Detergent”). Discoloration is irreversible.

Problem	Possible cause and solution
<p>White residue is visible on dishes and cutlery, clouding occurs on glassware; this film can be wiped off.</p>	<p>The rinse aid dosage is too low.</p> <ul style="list-style-type: none"> ■ Increase the dosage (see “Before using for the first time, Rinse aid”).
	<p>The salt reservoir is empty.</p> <ul style="list-style-type: none"> ■ Fill the salt reservoir (see “Before using for the first time, Dishwasher salt”).
	<p>The salt reservoir cap has not been screwed on correctly.</p> <ul style="list-style-type: none"> ■ Replace it, making sure that it screws back on correctly.
	<p>An unsuitable Tab detergent has been used.</p> <ul style="list-style-type: none"> ■ Change your detergent.
	<p>The softener assembly is programmed too low for the water hardness level.</p> <ul style="list-style-type: none"> ■ Program the softener assembly for harder water (see “Before using for the first time, Softener assembly”).
<p>There are rust stains on the cutlery.</p>	<p>The affected items are not corrosion resistant.</p> <ul style="list-style-type: none"> ■ There is no remedy. <p>Purchase cutlery which is dishwasher-safe.</p>
	<p>A program was not run after dishwasher salt was added. Traces of salt have got into the wash cycle.</p> <ul style="list-style-type: none"> ■ Always run the QuickIntenseWash program with the Short programming option selected and without any dishes in the dishwasher after adding dishwasher salt.



The salt reservoir cap has not been screwed on correctly.

- Replace it, making sure that it screws back on correctly.

Cleaning the drain pump and non-return valve

If the water has not been pumped away at the end of a program, the drain pump or the non-return valve might be blocked. They are, however, easy to clean.

- Disconnect the dishwasher from the electrical supply. Turn off the dishwasher and withdraw the plug.
- Take the filter system out of the wash cabinet (see “Cleaning and care, Cleaning the filters”).
- Scoop the water out of the wash cabinet using a suitable container or utensil.

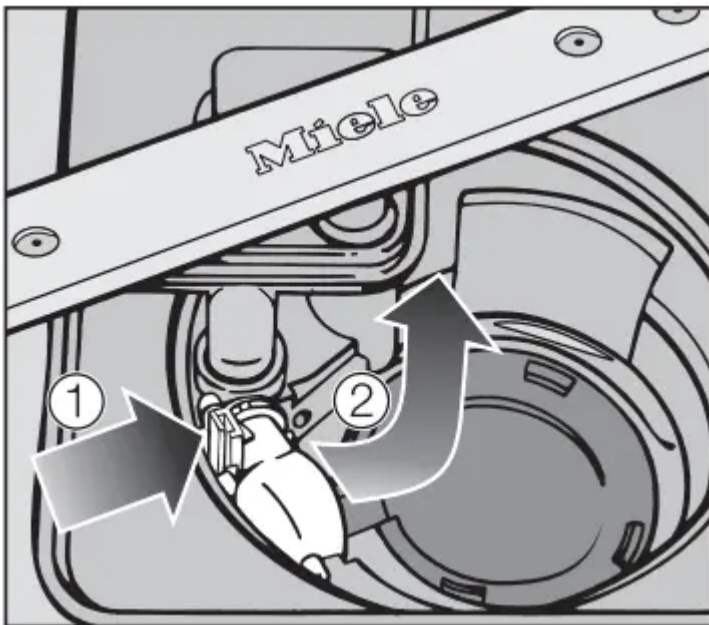

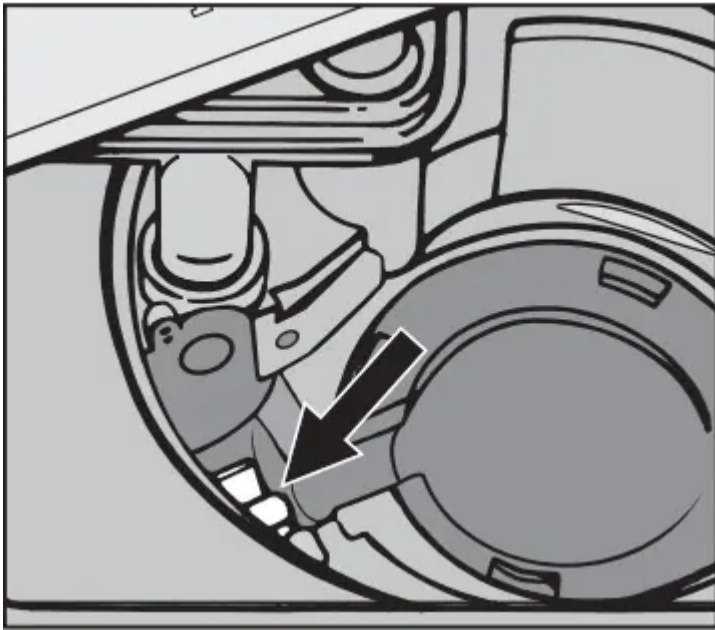

- Press the catch for the non-return valve inwards ①.
- Tilt the non-return valve inwards until it is released ②.
- Rinse it thoroughly under running water and remove any dirt from the nonreturn valve.



The drain pump is located underneath the non-return valve (see arrow).

- Remove all foreign objects from the drain pump (glass or bone splinters). Before returning the non-return valve, check that the drain pump is not blocked. Spin the impeller several times in both directions to check for obstructions.
- Carefully reinsert the non-return valve and secure it with the locking clamp.

 Make sure the locking clamp clicks into place!

 Be careful not to damage any delicate components when cleaning the drain pump and the non-return valve.

Warning

This content is compiled from multiple sources and is provided for reference purposes only. It may not be complete or fully applicable to all situations. If you are unable to resolve your issue, please contact the product manufacturer or an authorized service provider for official support.