

FEATURES AND BENEFITS

KEY PARTS AND COMPONENTS

A. INVERTER DIRECT DRIVE MOTOR

The inverter motor, which is directly connected to the tub, produces less noise and vibration while offering outstanding durability and a long lifespan.

B. COMPACT CAPACITY STAINLESS STEEL TUB

The efficient design provides capacity in a compact space

C. FRONT TOUCH PANEL

The simple LED display shows cycle options, setting, cycle status and estimated time remaining. The touch buttons offer more convenience and a premium design aesthetic.

D. KENMORE CONNECT™

Should you experience any problems with your washing machine, it has the capability of transmitting data via your telephone to the Kenmore Connect Team. The data transmitted from the machine can be used to analyze the issue, providing a fast and effective diagnosis.

E. REMOTE CONTROL

Don't want to bend down to reach the controls? Set cycles with the touch of a button on the available remote control. (Included accessory on some models or available for purchase online or in stores.)

Included Accessory



2 Inlet Hoses-Short



2 Inlet Hose Y-Connectors



Drain Hose Y-Connector



Drain Hose



Non-Skid Pads



Wrench



2 Tie Straps



2 Wire clamps and 1 Band clamp

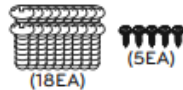

Screws



Detergent Dispenser

Required Accessory



2 Inlet Hoses

NOTE: For a list of Kenmore front-loading washers which are compatible with the pedestal washer, see the pedestal washer product pages at the Kenmore website

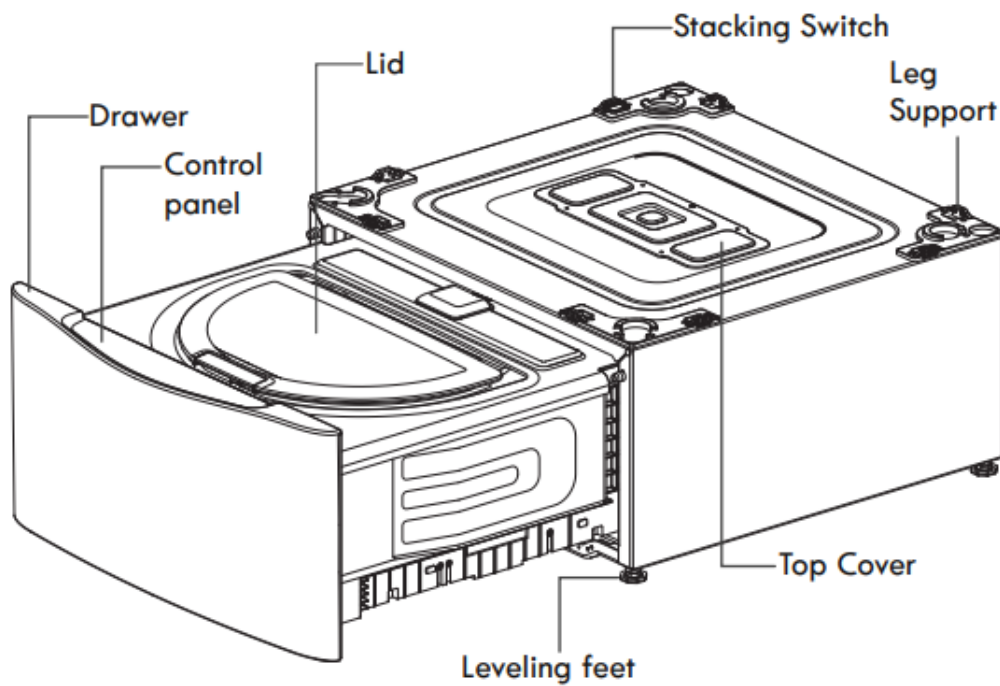

Appearance and specifications may vary without notice to improve the quality of the product.

KEY DIMENSIONS AND SPECIFICATIONS

Description	Top-Loading Compact Pedestal Washer
Electrical Requirements	120 VAC @ 60 Hz.
Max. Water Pressure	20~120 PSI (138~827 kPa)
Dimensions	5197* 27" (W) x 30 3/4" (D) x 14 1/8"(H), 50 1/2"(D with drawer open) 5199* 29" (W) x 30 7/8" (D) x 14 1/8"(H), 50 9/16"(D with drawer open)
Net Weight	5197* 100 lb (45.4kg), 5199* 105 lb (47.8kg)
Max. Spin Speed	700 RPM

HOW TO USE

CONTROL PANEL FEATURES

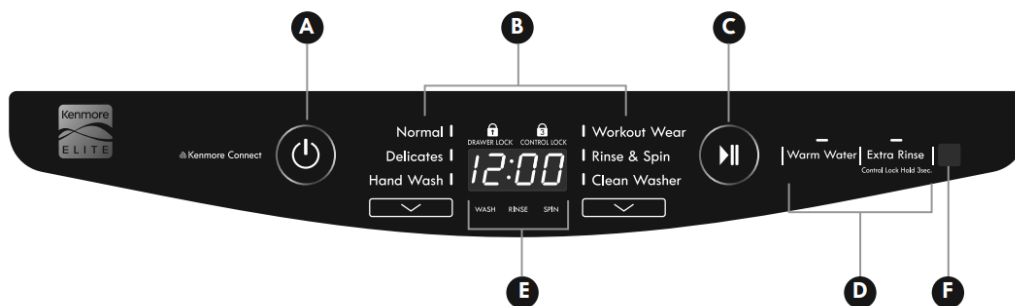

A. POWER (ON/OFF) BUTTON

Press to turn the washer ON. Press again to turn the washer OFF. Pressing the POWER button during a cycle will cancel that cycle and any load settings will be lost. The drawer will unlock after a brief pause.

NOTE:

- If there is any water remaining in the tub after the washer shuts off, it will drain following 4-minutes delay. The washer can be restarted any time before the drain begins. However, once the water begins to drain, all functions will be suspended until the water has been completely drained and the washer shuts off.
- When the Power button is pressed, the Normal cycle is selected by default. To modify the default options or choose another cycle, press the cycle selector (v) button to illuminate the display

B. CYCLE SELECTOR BUTTON

Press this button to select the desired cycle. Once the desired cycle has been selected, the standard presets will appear in the display. These settings can be adjusted using the cycle setting buttons any time before starting the cycle.

NOTE: To protect your clothing, not all settings are available on all cycle selections.

C. START/PAUSE BUTTON

Press this button to start the selected cycle. If the washer is running, use this button to pause the cycle without losing the current settings.

NOTE: If you do not press the START/PAUSE button within 4 minutes of selecting a cycle, the washer automatically turns OFF and all cycle settings are lost. Any water remaining in the tub will be drained.

D. OPTION BUTTONS

Use these buttons to adjust the settings for the selected cycle. The setting lights above the buttons illuminate to show the current selection.

E. TIME AND STATUS DISPLAY

The display shows the cycle status and estimated time remaining.

F. REMOTE CONTROL SENSOR

Use the remote to set the controls without bending down to reach the control panel.

OPERATING THE WASHER



1. SORT LAUNDRY AND LOAD THE WASHER

Sort laundry by fabric type, soil level, color and load size, as needed. Slide the pedestal washer drawer forward, open the lid and load items into the washer.



2. CLEANING PRODUCTS

Measure High-Efficiency (HE) detergent with the dispenser and pour it into the washer.



3. TURN ON THE WASHER

Press the POWER button to turn ON the washer. The cycle lights illuminate and a chime sounds.



4. SELECT A CYCLE



Press the cycle selector button to select the desired cycle. When you press Power the Normal cycle is selected by default. To modify the options, press the cycle selector button to activate the display. The optional remote control can also be used to select the desired cycle.



5. ADJUST SETTINGS

Default settings for the selected cycle can now be changed, if desired, using the option buttons.

NOTE: Not all options are available on all cycles. A different chime will sound and the light will not turn on if the selection is not allowed.

	<p>6. BEGIN CYCLE</p> <p>Press down gently on the lid handle until it clicks and slide the pedestal washer drawer closed. Press START/PAUSE to begin the cycle. The drawer locks, and the washer starts the cycle. If the START/PAUSE button is not pressed within 4 minutes, the washer shuts off and all settings are lost.</p>
	<p>7. ADD FABRIC SOFTENER</p> <p>A repeated chime sounds before the final rinse. When the chime sounds, pause the machine and add liquid fabric softener within three minutes, if desired. See Detergent and Dispenser Use for instructions on adding softener.</p>
	<p>8. END OF CYCLE</p> <p>When the cycle is finished, a melody will sound. Immediately slide the pedestal washer drawer out, open the lid, and remove the clothing from the washer to reduce wrinkling.</p>

CYCLE GUIDE

The cycle guide below shows the default settings, available options and recommended fabric types for each cycle. Allowable modifier adjustments are shown below the default setting for each cycle.

Key	
	Default
⦿	Available option

Cycle	Cycle Use	Est. Time	Wash Temp.	Extra Rinse	Control Lock
Normal	Lightly soiled cotton, t-shirts, towels, jeans, mixed loads.	39 ~ 116	Warm	⊙	⊙
			Cold		
Delicates	Lingerie, underwear, pajamas, delicates, etc.	47 ~ 103	Warm	⊙	⊙
			Cold		
Hand Wash	Sweaters, knits, items labeled hand-washable, etc.	47 ~ 103	Warm	⊙	⊙
			Cold		
Workout Wear	Specially designed/treated performance clothing.	43 ~ 103	Warm	⊙	⊙
			Cold		
Rinse & Spin	Pre-treats stains, or rinses off soap and drains tub	8 ~ 90		⊙	⊙
Clean Washer	Cleans tub and removes mildewy odor.	58	Warm		⊙
			Cold		

SPECIAL DRAIN FEATURE

This washer is equipped with a special feature that is designed to make the washer as safe as possible. If the washer is paused or shut off while there is still water in the tub, the water will drain automatically after several minutes of inactivity. This helps keep children safe by reducing the possibility of water remaining in the tub.

Any water remaining in the tub will automatically drain four minutes after the washer has shut off. If the washer is paused and the START/PAUSE button is not pressed within 4 minutes, the washer will shut off and all cycle settings will be lost. Any water remaining in the tub will be drained.

The washer can be turned on or restarted any time before the drain begins. However, once the washer begins to drain, all controls and functions will be disabled until the water has been completely drained and the washer shuts off.

TIME AND STATUS DISPLAY

The time and status display shows the estimated time remaining and cycle progress.

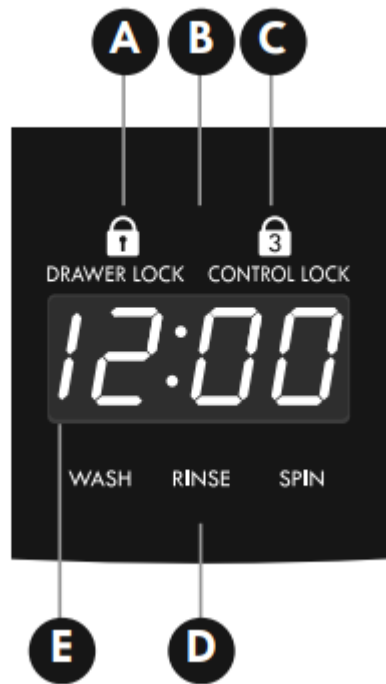

A. DRAWER LOCK INDICATOR

The DRAWER LOCK indicator will illuminate once a cycle has started. The indicator light will stay on until the cycle is paused, stopped or has finished.

B. LID OPEN

If the lid is open, the LED blinks. Close the lid, shut the drawer, and press START/PAUSE to start the cycle. Some models do not have the LID OPEN indicator. If the lid is closed and the lid error message is displayed, call for service.

C. CONTROL LOCK

When the Control Lock function is activated, the LED lights up. When the Control Lock function is set, except for the POWER button, the other functions are disabled. Once the Control Lock function is disabled, the LED will turn off.

D. CYCLE STATUS INDICATOR

These LEDs will illuminate when a cycle is selected to indicate which stages will run. When a cycle is running, the LED for the active stage will blink, and the LEDs for the remaining stages will remain steady. Once a stage is complete, the LED will turn off. If a cycle is paused, the active stage LED will stop blinking.

E. ESTIMATED TIME REMAINING

When a cycle is selected, the default time for that cycle is displayed. This time will change as modifiers or options are selected.

NOTE: The time shown is only an estimate. This time is based on normal operating conditions. Several external factors (load size, room temperature, incoming water temperature, water pressure, etc.) can affect the actual time.

CARE AND CLEANING

REGULAR CLEANING

CLEANING THE EXTERIOR

Proper care of your washer can extend its life. The outside of the machine can be cleaned with warm water and a mild, nonabrasive household detergent. Immediately wipe off any spills with a soft, damp cloth.

IMPORTANT: Do not use solvents, cleaning alcohols or similar products. Never use steel wool or abrasive cleaners because they can damage the surface.

CARE AND CLEANING OF THE INTERIOR

Use a towel or soft cloth to wipe around the washer lid opening and lid glass. Always remove items from the washer as soon as the cycle is complete. Leaving damp items in the washer can cause wrinkling, color transfer, and odor. Run the Clean Washer cycle once a month, or more often if needed, to remove detergent buildup and other residue.

CLEAN WASHER CYCLE

Some environmental and usage conditions can cause a residue to build up in the tub over time and can lead to a mildewy or musty smell. The Clean Washer cycle is specially designed to remove this buildup using bleach or other cleaners designed specifically for cleaning washing machines. Run the Clean Washer cycle once a month, or more often under heavy use conditions or if odor is present.

1. Remove any clothing from the tub.
2. Dilute 1/4 cup of liquid chlorine bleach in 1 quart of water and pour the mixture in the tub. Do not use any more than 1/4 cup of liquid bleach. Do not let bleach sit in the tub for a long period before running the Clean Washer cycle.

NOTE: For other tub cleaning products, follow the cleaner manufacturer's instructions and recommendations.

3. Close the lid and drawer and press the POWER button to turn the washer ON. Select the Clean Washer cycle then press the START/PAUSE button to begin the cycle. Selecting any other cycle after Clean Washer has been selected will cause the Clean Washer cycle to be cancelled.

4. After the cycle ends, open the lid and allow the tub interior to dry completely

REMOVING MINERAL BUILDUP

If you live in an area with hard water, mineral scale can form on internal components of the washer.

Use of a water softener is recommended in areas with hard water. Use a descaler, such as Washer Magic®, to remove visible mineral buildup. After descaling, always run the Clean Washer cycle before washing clothing.

Mineral scale and other spots may be removed from the stainless steel tub using a stainless steel cleaner. Do NOT use steel wool or abrasive cleaners.

LEAVE THE LID OPEN

If the washer will not be used for several days, pull the washer drawer open, raise the lid, and leave the lid and drawer open to allow the tub to dry.

MAINTENANCE

CLEANING THE WATER INLET FILTERS

If the washer does not fill properly, an error message will show on the display. The inlet valve filter screens could be plugged by hard water scale, sediment in the water supply, or other debris.

NOTE: The inlet screens protect the delicate parts of the inlet valve from being damaged by particles that could enter the valves with the water supply. Operating the washer with these filters removed could cause a valve to stick open resulting in flooding and/or property damage.

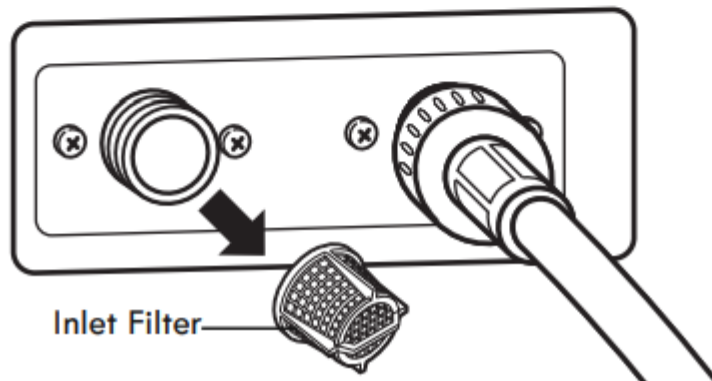
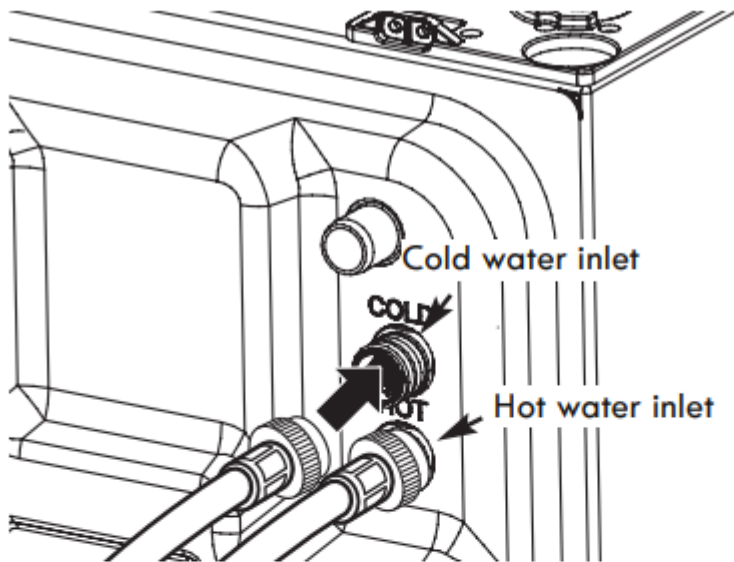

1. Turn OFF both water faucets completely. Unscrew the hot and cold water lines from the back of the washer.
2. Carefully remove the filters from the water valves and soak them in white vinegar or a lime scale remover, following the manufacturer's instructions. Be careful not to damage the filters while cleaning.
3. Rinse thoroughly before reinstalling. Press the filters back into place.
4. Before reattaching the hoses, flush the hoses and water lines by running several gallons of water into a bucket or drain, preferably with the faucets wide open for maximum flow.

STORING THE WASHER

If the washer will not be used for an extended period of time and is in an area that could be exposed to freezing temperatures, perform the following steps to protect the washer from damage.

1. Turn OFF the water supply.
2. Disconnect the hoses from the water supply and drain water from the hoses.
3. Plug the power cord into a properly grounded electrical outlet.

4. Add 1/4 gallon of nontoxic recreational vehicle (RV) antifreeze to the empty tub and close the lid. Never use automotive antifreeze.
5. Press the POWER button, then select the Spin Only cycle (see page 20). Press the START/PAUSE button to activate the drain pump. Allow the drain pump to run for one minute, then press the POWER button to shut off the washer. This will expel some of the antifreeze, leaving enough to protect the washer from damage.
6. Unplug the power cord, dry the tub interior with a soft cloth, and close the lid.
7. Store the washer in an upright position.
8. To remove the antifreeze from the washer after storage, run a complete wash cycle using detergent. Do not add laundry to this cycle.

TROUBLESHOOTING

FAQS: FREQUENTLY ASKED QUESTIONS

Q: Can the pedestal washer and the front-loading washer be run at the same time?

A: Yes. The pedestal washer is designed to operate simultaneously under compatible Kenmore frontloading washers produced after 2009. It is not designed for operation under Kenmore top-loading washers, Kenmore dryers, non-compatible appliances, or as a standalone unit. For more information regarding compatibility, see the pedestal washer product pages at the website www.Kenmore.com

Q: How much clothing can be loaded in the pedestal washer?

A: The tub is designed to hold a maximum of 4 lb. (One thick bath towel weighs about one pound when dry.) Do not overload the washer tub. The clothing should fit loosely into the tub and the lid should close easily

Q: How much detergent, softener, or bleach should be used per load?

How/when is it added to the machine?

A: Detergent:

- The pedestal washer requires very little detergent. Most normal loads only require 1 tsp (5 g) of HE detergent. Use a maximum of 2 tsp (10 g) of HE detergent. Do not use a full detergent pod.
- Pour the detergent in the measuring device/dispenser provided with the machine. Place the dispenser in the tub with the clothing before beginning the cycle.
- If the dispenser is missing, place the 1–2 tsp. (5–10 g) detergent directly into the tub.
- For more information, see Detergent and Dispenser Use.

Fabric Softener:



- Use $\frac{1}{4}$ the amount recommended by the manufacturer for a normal load. Use the dispenser provided with the machine. For instructions, see Using Fabric Softener.

Bleach:

- Do not use liquid or powdered bleach to launder items in the pedestal washer. To safely and effectively launder items using bleach, use the bleach dispenser in the front-loading washer.

Q: Can I slide the drawer out while the cycle is running?

A: No. The drawer locks for safety during operation. Pause the cycle to open the drawer.

Q: What if I want to add an item after I've started the cycle?

A: Press the Start/Pause button to pause the cycle. After the drawer unlocks, add the item and press Start/Pause to restart the cycle. Wash performance may be affected if the item is added after the first few minutes.

Q: How do I dry out the tub after the cycle is finished?

How do I keep the tub free from mildew and odors?

A: For best care, wipe the lid and tub dry with a soft cloth or towel after use. Leave the drawer and the lid open to allow maximum air circulation after use. Run the Clean Washer cycle once a month or more frequently as needed. TCL is displayed after every 30 cycles as a reminder.

NORMAL SOUNDS YOU MAY HEAR

The following sounds may be heard while the washer is operating. They are normal.

CLICKING:

Lid lock relay when the lid locks and unlocks.

SPRAYING OR HISSING:

Water spraying or circulating during the cycle.

HUMMING OR GURGLING:

Drain pump is pumping water from the washer at times during a cycle

WATER SLOSHING SOUND:

A liquid in the balance ring around the wash basket helps the basket spin smoothly.

SOUND OF WATER BEING ADDED AFTER THE WASHER HAS ALREADY BEEN IN OPERATION

- The washer adapts to the load size and type to add more water to the cycle as needed.
- The wash load may be unbalanced. If the washer senses that the load is unbalanced, it will stop and refill to redistribute the load.

- The washer may be diluting laundry additives to add to the wash load.

BEFORE CALLING FOR SERVICE

Your washing machine is equipped with an automatic error-monitoring system to detect and diagnose problems at an early stage. If your washer does not function properly or does not function at all, check the following before you call for service:

Problem	Possible Cause	Solutions
Rattling and clanking noise	Foreign objects, such as keys, coins, or safety pins may be in tub .	Stop washer, check tub for foreign objects. If noise continues after washer is restarted, call for service.
Thumping sound	Heavy wash loads may produce a thumping sound.	This is normal. If sound continues, washer is probably out of balance. Stop and redistribute wash load.
	Wash load may be out of balance.	Pause the cycle and redistribute the load after the lid unlocks.
Vibrating noise	Packaging materials were not removed.	See the Unpacking and Removing Shipping Material section in the installation requirements section.
	Wash load may be unevenly distributed in the tub.	Pause the cycle and redistribute the load after the lid unlocks.
	Not all leveling feet are resting firmly and evenly on the floor.	See Leveling the Washer in the Installation Instructions section.
	Floor not rigid enough.	Make sure that the floor is solid and does not flex. See Flooring in the Installation Requirements section.
Water leaking	Inlet hose connection is loose at faucet, washer, or Y-connector.	Check hoses and Y-connectors for leaks, cracks and splits. Check and tighten hose connections.
	House drain pipes are clogged.	The washer pumps out water very rapidly. Check for water backing up out of the drain pipe during drain. If water is seen coming out of the drain, check for proper drain hose installation and check for restrictions in the drain. Contact a plumber to repair drain pipe.



	Drain hose has come out of drain connector or is not inserted far enough.	Tie drain hose to inlet hose or standpipe to prevent it from coming out during drain. For smaller drain pipes, insert the drain hose into the pipe as far as the drain hose flange. For larger drain pipes, insert the drain hose into the pipe 1-2 inches past the flange.
	Load is too large for the tub.	Reduce the load or use the full-size washing machine. Use the BULKY/ BEDDING cycle on the front-loading washer for large or bulky items. Stop the washer and check the load. Make sure the load fits loosely in the tub and the lid closes easily.
Wrinkling	Washer not unloaded promptly.	Always remove items from the washer as soon as the cycle is complete.
	Washer overloaded.	The washer can be fully loaded, but the tub should not be tightly packed with items. The lid of the washer should close easily.
	Hot and cold water inlet hoses are reversed. .	Hot water rinse can set wrinkles in garments. Check the inlet hose connections
Excessive sudsing	Too much detergent or incorrect detergent.	HE detergents are formulated specifically for High-Efficiency washers and contain suds-reducing agents. Only use detergent with the HighEfficiency (HE) logo. For detergent quantities refer to the How to Use section. If sudsing or detergent residue continue to be an issue, add an Extra Rinse.
Staining	Bleach or softener was added directly to the wash load in the tub.Washer was not unloaded promptly.	Always remove items from the washer as soon as possible after the cycle is complete.
	Clothes were not properly sorted.	Always wash dark colors separately from light colors and whites to prevent discoloration.



		Never wash heavily soiled items washed with lightly soiled items
Washer will not turn ON	Power cord is not properly plugged in.	Make sure that the plug is plugged securely into a grounded, 3-prong, 120-VAC, 60-Hz outlet.
	House fuse is blown, circuit breaker has tripped, or power outage has occurred.	Reset circuit breaker or replace fuse. Do not increase fuse capacity. If the problem is a circuit overload, have it corrected by a qualified electrician.
Wash cycle time is longer than usual	The washer automatically adjusts the wash time for the amount of laundry, water pressure and other operating conditions.	This is normal. The washer adjusts cycle time automatically to provide optimal results for the selected cycle. The time remaining shown in the display is only an estimate. Actual time may vary
Musty or mildewy odor in washer	Incorrect or too much detergent has been used.	Use only High-Efficiency (HE) detergent in accordance with the manufacturer's instructions. This machine requires very little detergent. 1-2 teaspoons is sufficient to wash a full load.
	Inside of tub was not cleaned properly.	Run the Tub clean cycle regularly.
Water leaks	Oversudsing of detergent.	Oversudsing may create leaks, and may be caused by the type and amount of detergent used. High-Efficiency detergent is the only detergent recommended. Always reduce the amount of detergent if the load is small or lightly soiled, or if your water is very soft. Never use more than the maximum amount shown in the dispenser provided.
Washer will not operate		This is normal. Press the POWER button to turn the washer on.



	Control panel has powered off due to inactivity.	
	Washer is unplugged.	Make sure cord is plugged securely into a working outlet.
	Water supply is turned off.	Turn both hot and cold faucets fully on.
	Controls are not set properly.	Make sure the cycle was set correctly, close the lid and press the START/PAUSE button.
	Lid or drawer is open	The washer will not operate if the lid is open. Close the lid and drawer make sure that nothing is caught under the lid preventing it from closing completely.
	Circuit breaker/fuse is tripped/ blown.	Check house circuit breakers/fuses. Replace fuses or reset breaker. The washer should be on a dedicated branch circuit. The washer will resume the cycle where it stopped once power is restored.
	Control needs to be reset.	Press the POWER button, then re-select the desired cycle and press the START/PAUSE button.
	START/PAUSE was not pressed after a cycle was set.	Press the POWER button then re-select the desired cycle and press the START/PAUSE button. The washer will shut off if the START/PAUSE button is not pressed within 4 minutes.
	Extremely low water pressure.	Check another faucet in the house to make sure that household water pressure is adequate.
	Washer is too cold.	If the washer has been exposed to temperatures below freezing for an extended period of time, allow it to warm up before pressing the POWER button. Otherwise, the display will not come on.
Washer not filling properly	Filter clogged.	Make sure the inlet filters on the fill valves are not clogged. Refer to the filter cleaning instructions.
	Inlet hoses may be kinked.	Check that inlet hoses are not kinked or clogged.



	Energy efficiency.	This is a High Efficiency (HE) washer. As a result, the water level settings for this washer may be different than for conventional washers.
	Insufficient water supply.	Make sure that both hot and cold water faucets are turned on all the way.
	lid and drawer are open.	The washer will not operate if the lid is open. Close the lid and make sure that nothing is caught under the lid preventing it from closing completely.
	Hot and cold inlet hoses are reversed.	Check inlet hose connections. Make sure the hot water supply is connected to the hot inlet valve, and the cold water supply is connected to the cold inlet valve.
	Water level is too low.	This is a high efficiency washer. The water will not normally cover the clothes. The fill level is optimized for the wash motion to achieve the best wash performance.
Washer will not drain water	Kinked drain hose.	Ensure that the drain hose is not kinked.
	Drain located higher than 96 in. (243.84 cm). above the floor.	Make sure that the drain hose is no higher than 8 ft. above the bottom of the washer and is no more than 5 ft. away from the washer.
Poor stain removal	Heavily soiled load.	The pedestal washer is designed to gently and effectively care for lightly soiled loads. Heavier soils and tougher stains may require the extra cleaning power of the features on the front-loading washer.
	Previously set stains.	Articles that have previously been washed may have stains that have been set. These stains may be difficult to remove and may require hand washing or pre-treating to aid in stain removal.
Water leaks every load	Hoses not installed correctly.	Check all fill and drain hose connections to ensure that they are tight and secure.

	<p>Hybrid dryer drain hose not installed properly</p>	<p>Do not insert hybrid dryer hose into Y-connector further than 3/4 in. See Connecting the Drain Hose.</p> <p>Check clamps and tie straps to ensure they are secure. Install clamps and tie straps if missing. See Connecting the Drain Hose.</p>
--	---	--

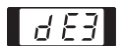
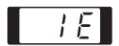

ERROR CODES

Problem	Possible Cause	Solutions
<p>The display shows:</p> 	<p>Drawer is not closed properly</p>	<p>Close the drawer and press START/PAUSE button to start the cycle.</p> <p>If the drawer is closed and the drawer lock error message is displayed, call for service</p>
<p>The display shows:</p> 	<p>Lid is not closed properly</p>	<p>Open the drawer and make sure the latch area is free of clothing or other obstructions.</p> <p>Close the lid, shut the drawer, and press START/PAUSE to start the cycle.</p> <p>If the lid is closed and the lid error message is displayed, call for service</p>
<p>Washer fills with water slowly or not at all, or the display shows:</p> 	<p>Water supply faucets are not fully open.</p>	<p>Make sure that the water faucets are fully open.</p>
	<p>Water line hoses are kinked, pinched, or crushed.</p>	<p>Make sure that the hoses are not kinked or pinched. Be careful when moving the washer during cleaning and maintenance.</p>
	<p>Water inlet filters are clogged.</p>	<p>Clean the inlet filters. See Maintenance in the Care and Cleaning section.</p>
	<p>Water supply pressure to faucet or house is too low.</p>	<p>Check another faucet in the house to make sure that household water pressure is adequate and flow is not restricted. Disconnect the inlet hose from the washer and run a few gallons of water through the hose to flush the water supply lines. If flow is too low, contact a plumber to have the water lines repaired.</p>
	<p>Water supply connected with leaklimiting hoses.</p>	<p>Hoses designed to limit leaks can trip falsely and prevent the washer from filling. The use of leak limiting hoses is not recommended.</p>
<p>Washer will not turn on</p>	<p>Power cord is not properly plugged in.</p>	<p>Make sure that the plug is plugged seruely into a grounderd, 3-prong. 120-VAC, 60-Hz. outlet.</p>

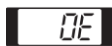
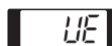
	House fuse is blown, circuit breaker has tripped, or power outage has occurred.	Reset circuit breaker or replace fuse. Do not increase fuse capacity. If the problem is a circuit overload, have it corrected by a qualified electrician.
Water in the washer drains slowly or not at all, or the display shows: 	Drain hose is kinked, pinched, or clogged	Make sure the drain hose is free of clogs, kinks, etc., and is not pinched behind or under the washer.
	Drain discharge is more than 53" (134.6 cm) above bottom of washer.	Adjust or repair drain. Maximum drain height is 53" (134.6 cm).
Washer chimes repeatedly before final rinse	This is not an error. This is an alert to allow the addition of liquid fabric softener before the final rinse.	See Using Fabric Softener, page 16, for instructions on adding liquid fabric softener to the load. To disable or enable the fabric softener alert, press and hold Warm Water and Extra Rinse at the same time for three seconds.
The display shows: 	If the rebalancing operation (see above) is not successful, this error will be displayed.	The automatic attempt to rebalance the load was not successful. The cycle has been paused to allow the load to be manually adjusted.
	The load is too small.	Small loads may need additional items to be added to allow the washer to balance the loads.
	Heavy articles are mixed with lighter items.	The load may have heavy items loaded with lighter items. Always try to wash articles of somewhat similar weight to allow the washer to evenly distribute the weight of the load for spinning.
	The load is out of balance.	

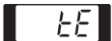
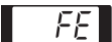
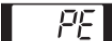
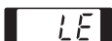
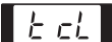
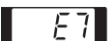
		Manually redistribute the load if articles have become tangled preventing the automatic distribution from working properly.
The display shows: 	Control error.	Unplug the power cord and contact your nearest service center.
The display shows: 	Water level is too high due to a faulty water valve.	Close the water faucets, unplug the washer, and call for service.
The display shows: 	The water level sensor is not working correctly.	Close the water faucets, unplug the washer, and call for service.
The display shows: 	A motor error has occurred.	Allow the washer to stand for 30 minutes and then restart the cycle. If the LE error code persists, call for service.
The display shows: 	It is time to run the Clean Washer cycle.	Empty the tub, add a diluted solution of 1/4 cup bleach to 1 qt. water to the tub, and select the Clean Washer cycle. To skip the Clean Washer cycle when alerted, press the cycle selector buttons. The message continues to appear for a few more wash cycles and then disappears until the next scheduled cleaning cycle.
The display shows: 	Pedestal washer is being operated without a full-size washer.	The pedestal washer will not operate as a standalone unit. It must be stacked under a full-size compatible Kenmore appliance.
	Stacking switch is not working properly.	The stacking switch will not operate properly if the unit is stacked under a non-compatible Kenmore appliance, or a Kenmore appliance manufactured before 2009.

Warning

This content is compiled from multiple sources and is provided for reference purposes only. It may not be complete or fully applicable to all situations. If you are unable to resolve your issue, please contact the product manufacturer or an authorized service provider for official support.

Document generated by [ManualsFile](#)