

IMPORTANT SAFETY INSTRUCTIONS

WARNING: When using the dishwasher, follow basic precautions, including the following:

- Read all instructions before using the dishwasher.
- Use the dishwasher only for its intended function.
- Use only detergents or rinse agents recommended for use in a dishwasher, and keep them out of the reach of children.
- When loading items to be washed:
 - 1) Locate sharp items so that they are not likely to damage the door seal; and
 - 2) Load sharp knives with the handles up to reduce the risk of cut-type injuries.
- Do not wash plastic items unless they are marked “dishwasher safe” or the equivalent. For plastic items not so marked, check the manufacturer's recommendations. g Do not touch the heating element during or immediately after use.
- Do not operate the dishwasher unless all enclosure panels are properly in place.
- Do not tamper with controls.
- Do not abuse, sit on, or stand on the door, lid, or dish racks of the dishwasher.
- To reduce the risk of injury, do not allow children to play in or on the dishwasher.
- Under certain conditions, hydrogen gas may be produced in a hot water system that has not been used for two weeks or more. **HYDROGEN GAS IS EXPLOSIVE.** If the hot water system has not been used for such a period, before using the dishwasher turn on all hot water faucets and let the water flow from each for several minutes. This will release any accumulated hydrogen gas. As the gas is flammable, do not smoke or use an open flame during this time.
- Remove the door or lid to the washing compartment when removing an old dishwasher from service or discarding it.

WARNING

Tip Over Hazard

- Do not use dishwasher until completely installed.
- Do not push down on open door.
- Doing so can result in serious injury or cuts.

GROUNDING INSTRUCTIONS

For a grounded, cord-connected dishwasher:

The dishwasher must be grounded. In the event of a malfunction or breakdown, grounding will reduce the risk of electric shock by providing a path of least resistance for electric current. The dishwasher is equipped with a cord having an equipment-grounding conductor and a grounding plug. The plug must be plugged into an appropriate outlet that is installed and grounded in accordance with all local codes and ordinances.

WARNING: Improper connection of the equipment grounding conductor can result in a risk of electric shock.

Check with a qualified electrician or service representative if you are in doubt whether the dishwasher is properly grounded. Do not modify the plug provided with the dishwasher; if it will not fit the outlet, have a proper outlet installed by a qualified electrician.

For a permanently connected dishwasher:

The dishwasher must be connected to a grounded metal, permanent wiring system, or an equipment-grounding conductor must be run with the circuit conductors and connected to the equipment-grounding terminal or lead on the dishwasher.

KEY USAGE TIPS

Filtration system and maintenance

Your dishwasher has the latest technology in dishwasher filtration.

This filtration system minimizes sound and optimizes water and energy conservation while providing superior cleaning.

The filter system consists of two parts, an upper filter assembly and lower filter.

IMPORTANT: To avoid damage to dishwasher, do not operate your dishwasher without filters properly installed. Be sure lower filter is securely in place and upper filter assembly is locked into place. If upper assembly turns freely, it is not locked into place.

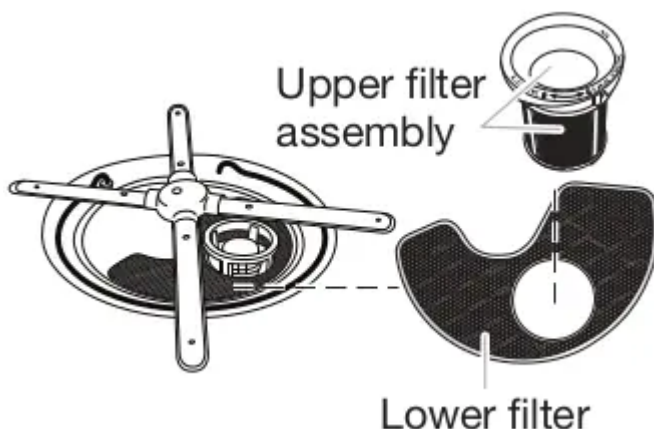

The filters may need to be cleaned when: u Visible objects or soils are on upper filter assembly.

Dishes feel gritty to the touch.

See the “Filtration System” section in the full online User Instructions for complete removal and maintenance schedule.

IMPORTANT: Do not use a wire brush, scouring pad, etc. as they may damage the filters. Rinse filter under running water until soils are removed. If you have hard to remove soils or calcium deposits because of hard water, a soft brush may be required.



Drying — Rinse aid is essential

You must use a drying agent such as a rinse aid for good drying performance. Rinse aid along with the Heat Dry.

Extended Heat Dry option will provide best drying and avoid excessive moisture in dishwasher interior.

Heat Dry

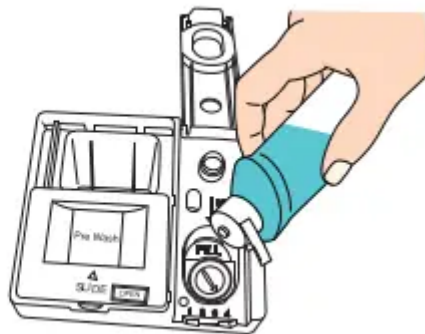

Energy efficiency

Energy efficiency is gained by extending cycle time and reducing the amount of wattage and water used during your dishwasher’s cycle. For exceptional cleaning, cycles are longer due to the soak and pauses.

Efficient dishwashers run longer to save water and energy. just as driving a car slower saves on gas. Your first cycle will run longer to calibrate the optical water sensor.

Premium Top Rack Adjuster

You can raise or lower the top rack to fit tall items in either the top or bottom rack. Adjusters are located on each side of the top rack.

To raise the rack: Press both rack adjuster thumb levers and lift the rack until it is in the up position and level.

To lower the rack: Press both rack adjuster thumb levers and slide the rack to its down position and level.

NOTE: The top rack must be level.

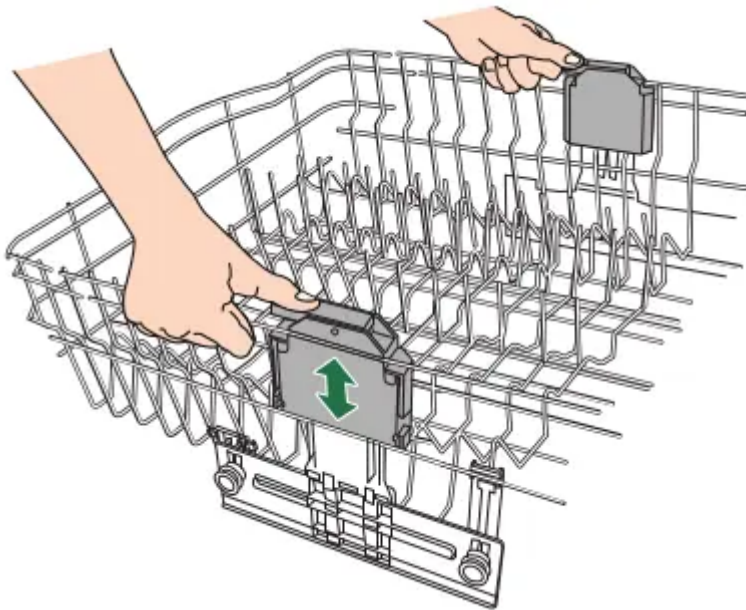

Touch START/RESUME every time you add a dish

IMPORTANT: If anyone opens the door (such as for adding a dish, even during the Delay option). Start/Resume must be touched each time to resume the cycle.

Push the door firmly closed within 4 seconds of touching Start/Resume. If the door is not closed within 4 seconds, the Start keypad light will flash, an audible tone will be heard, and the cycle will not start.

Start
RESUME

OPERATING YOUR DISHWASHER

1. Prepare and load the dishwasher

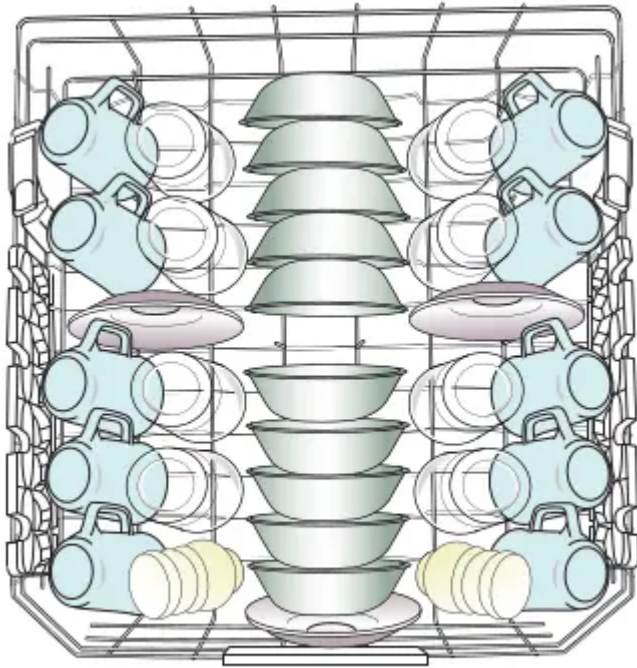

10-place load – upper rack

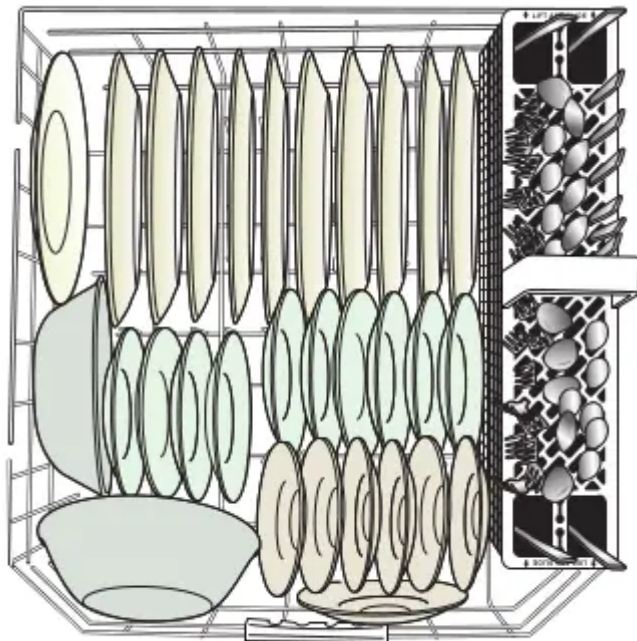

10-place load – lower rack

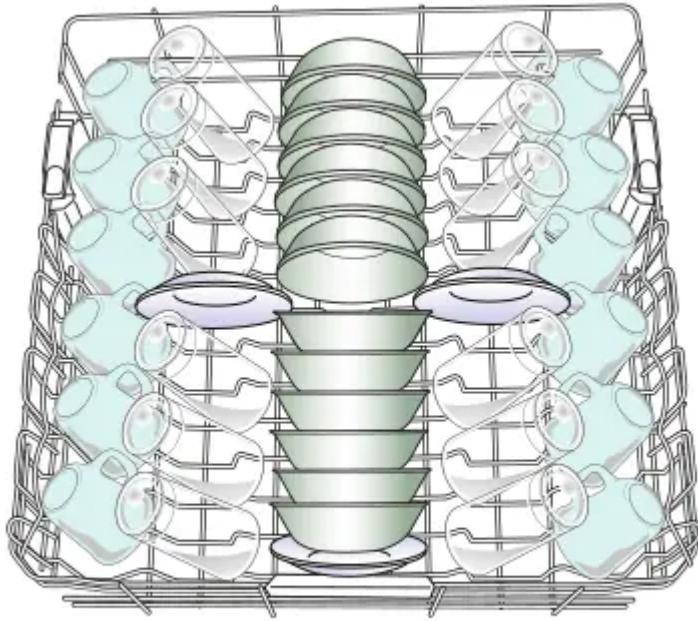

12-place load – upper rack

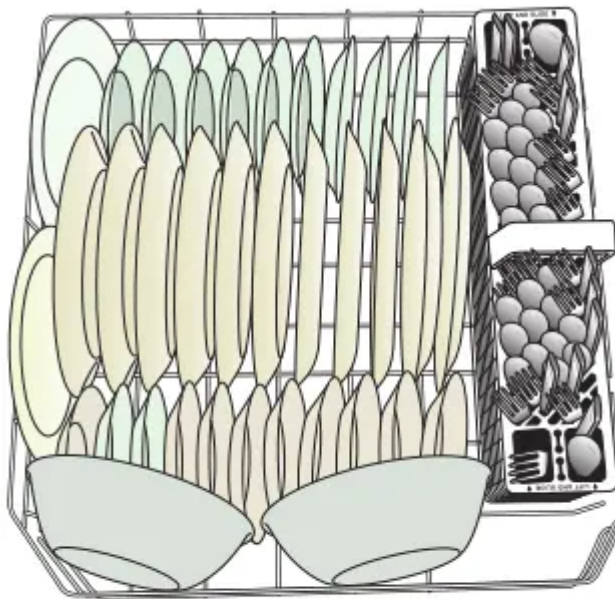

12-place load – lower rack

IMPORTANT: Remove leftover food, bones, toothpicks, and other hard items from dishes. Remove labels from containers before washing.

Make sure when the dishwasher door is closed no items are blocking detergent dispenser. Items should be loaded with soiled surfaces facing down and inward to the spray as shown in the graphics above. This will improve cleaning and drying results. Angle dirtiest dish surface downward, allowing space for water to flow up through rack and between dishes. Avoid overlapping items, like bowls or plates that may trap food. Place plastics, small plates, and glasses in upper rack.

Wash only items marked “dishwasher safe.”

To avoid thumping/clattering noises during operation. load dishes so they do not touch one another. Make sure lightweight load items are secured in racks.

Use the slots in the covers and suggested loading patterns to keep your silverware separated for optimum wash.

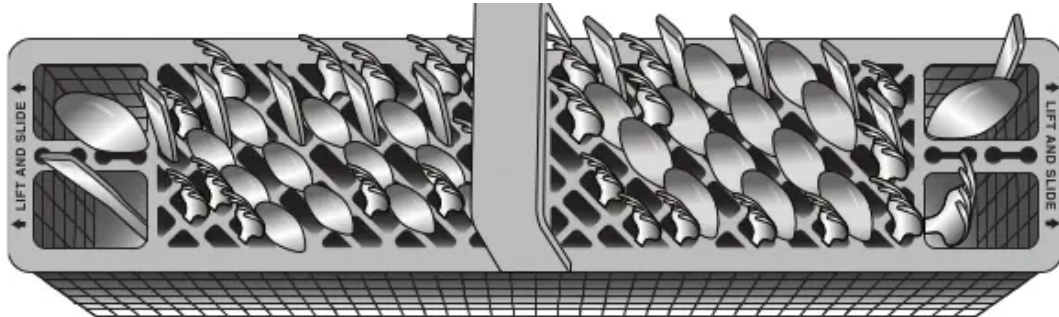

If your silverware does not fit into the designated slots. lift and slide covers off to remove them and mix silverware types to keep them separated.

When loading silverware. always place sharp items pointing down and avoid “nesting” as shown.



2. Check that all arms spin freely

Items in the rack can block the spray arms.

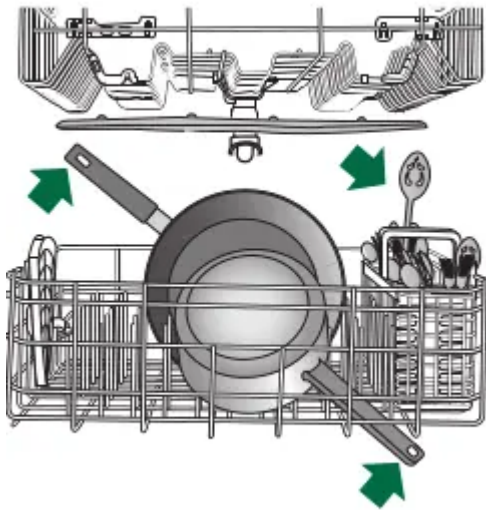

3. Add detergent

Premeasured Detergents

High-quality premeasured tablets and packs are recommended for improved performance.

Quality tablets and packs have been proven better than powder, liquid, or gel detergents at reducing filming on dishes.

Using tablets and packs over time will start to reduce or eliminate white film.

They are suitable for all water hardness and soil levels. Also, by using a rinse aid, you can minimize repeat buildup of white film (not all packs and tablets contain rinse aid). Always place premeasured detergents in main compartment and close lid.

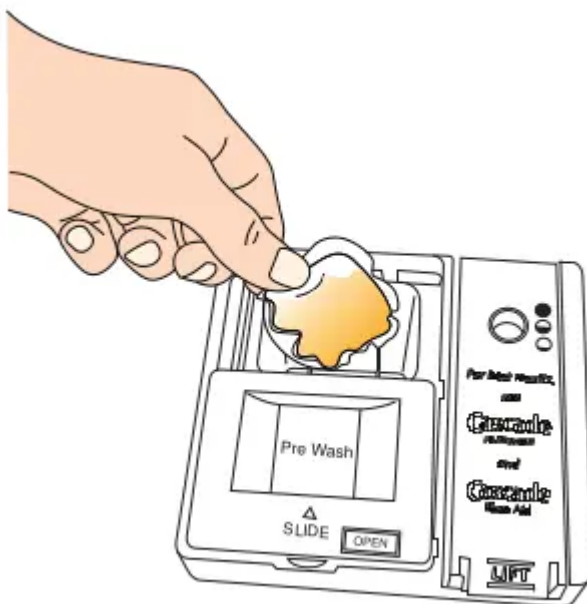

NOTE: Follow instructions on the package when using other dishwasher detergent types. See the complete User Instructions for more details about powders, liquids, and gels.

Use automatic dishwasher detergent only. Add detergent just before starting a cycle.

Fresh automatic dishwasher detergent results in better cleaning. Store tightly closed detergent container in a cool, dry place.

To close lid

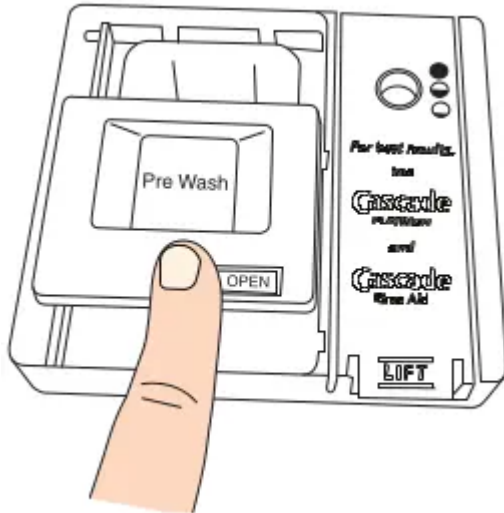

Place selected detergent in the dispenser. Place finger, as shown, and slide lid closed. Press firmly until it clicks.

To open lid

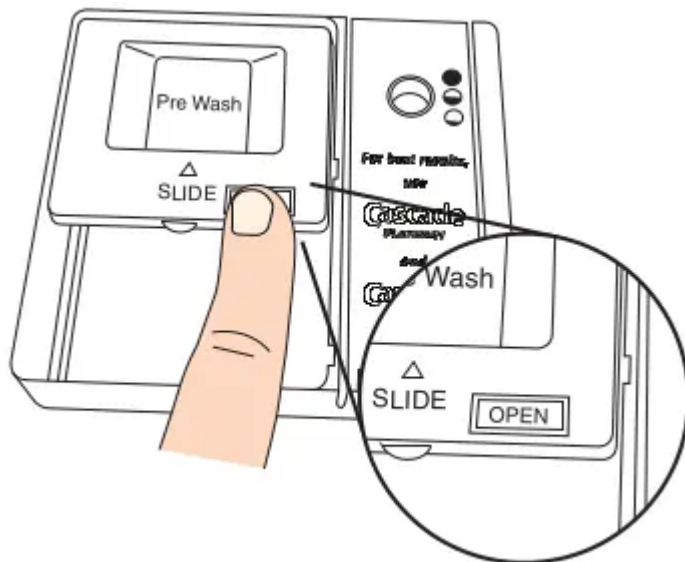

Push OPEN, as shown, and the lid will slide open.

4. Add rinse aid

- Your dishwasher is designed to use rinse aid for good drying performance. Without rinse aid, your dishes and dishwasher interior will have excessive moisture. The heating and drying options will not perform as well without rinse aid.

- Rinse aid keeps water from forming droplets that can dry as spots or streaks. It also improves drying by allowing water to drain off of dishes after final rinse. Rinse aid does not adhere to dishware. and when used. it is dispensed during each cycle.

- To add rinse aid. open the dispenser lid by gently pushing in the center of the lid with your thumb while lifting up on the edge.

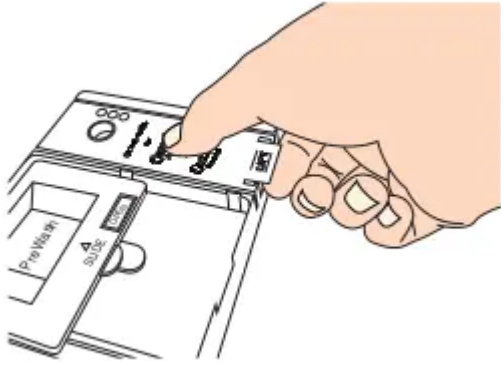

- Pour rinse aid into the opening until the indicator level shows that it is full.

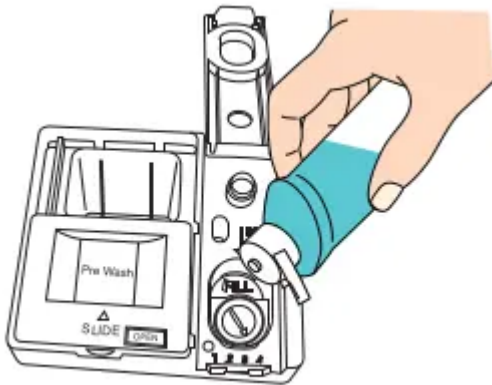

- Close dispenser by pushing down gently on the lid.

NOTE: For most water conditions. the factory setting will give good results.

- If you are experiencing poor drying performance. try a higher setting. Turn the arrow adjuster to the next higher number to increase the amount of rinse aid.





5. Select a cycle

Efficient dishwashers run longer to save water and energy, just as driving a car slower saves on gas. Typical cycle time is approximately 2½ hours but can take less or more time to complete depending on selections. Push door firmly closed and touch START to repeat the same cycle and options as in the previous wash cycle, or select another cycle appropriate for your load. See the Cycle Guide.

6. Select options

You can customize your cycles by selecting the options desired. See the Cycle Guide. If you change your mind, touch the option keypad again to turn off the option. Not all options are available for every cycle. If an invalid option is selected for a given cycle, the lights will flash. Adding options may increase the cycle time.

7. Start or resume a cycle

NOTE: If needed, run hot water at the sink nearest your dishwasher until water is hot. Turn off water. With door firmly closed, touch START.

IMPORTANT: If the door is opened for more than a few seconds after the cycle is started (even during the Delay time), the Start keypad must be touched again after the door is closed. If Start keypad is not touched, the Start keypad light will flash, and audible tone will be heard, and cycle will not resume.

8. Follow the progress of your dishwasher

The display will indicate cycle progress such as Washing, Drying, Clean, and Sanitized. The cycle has completed when the Clean light is lit. Refer to the Control chart in the Cycle Guide section for operation of the Sanitized indicator.

CYCLE GUIDE

IMPORTANT: The sensor in your dishwasher monitors the soil level. Cycle time and/or water usage can vary as the sensor adjusts the cycle for the best wash performance. If the incoming water is less than the recommended temperature or food soils are heavy, the cycle will automatically compensate by adding time, heat, and water as needed.

CYCLES		ESTIMATED WASH TIME* W/O OPTIONS (HR:MIN)	WATER USAGE GALLONS (LITERS)
ProWash Soil - Sense	This cycle senses the load size, soil amount, and toughness of soil, to adjust the cycle for improved cleaning, using only the amount of water and energy needed. The ProWash™ cycle is automatically selected if you first touch the Start keypad. Includes a heated drying option.*	2:10 to 3:15	3.38 to 7.4 (12.8 to 28.0)
Tough	Use for hard-to-clean, heavily soiled pots, pans, casseroles, and regular tableware. Includes a heated drying option.	2:45 to 3:25	7.4 (28.0)
Normal	This cycle is recommended for daily, regular, or typical use to completely wash and dry a full load of normally soiled dishes. This dishwasher's government energy certifications were based on the Normal cycle with only the Heat Dry option selected.**	2:00 to 3:10	2.4 to 7.4 (9.09 to 28.0)
Express Wash	For fast results, the Express Wash will clean dishes using slightly more water and energy. For improved drying, select a heated drying option. NOTE: Some detergents are not recommended for short wash cycles, please refer to your detergent packaging for more information. Includes a heated drying option.	0:55 to 1:05	7.87 (29.8)
Rinse Only	Use for rinsing dishes, glasses, and silverware that will not be washed right away. Do not use detergent.	0:18	2.0 (7.5)

* The government energy certifications are not based on this cycle. See the Normal cycle description for the government energy certification cycle. Using the ProWash™ cycle may increase your energy usage.

** No other washing and drying temperature options were selected, and the dishwasher was not subjected to truncated testing. Rinse aid was not used, and there was no detergent used in the prewash.

OPTIONS	CAN BE SELECTED WITH	WHAT IT DOES	ADDED TIME TO CYCLE (HR:MIN)	ADDED WATER GALLONS (LITERS)
Hi-Temp Wash Sound On/Off Hold 3 Sec	ProWash™ Normal	Raises the main wash temperature to improve cleaning for loads containing tough, baked-on food.	0:00 to 0:30	0 to 3.0 (0 to 11.2)
Extended Heat Dry Heat Dry	Available with any cycle except Rinse Only	Activates the heating element at the end of a wash cycle to speed drying times. Heat Dry defaults to On when any cycle is selected, except for Express Wash and Rinse Only.	Heat Dry: 0:10 to 0:50 Extended Heat Dry (includes Heat Dry time): 0:40 to 1:20	0
Extended Heat Dry Heat Dry	Available with any cycle except Rinse Only	Activates the heating element at the end of a wash cycle to speed drying times. Heat Dry defaults to On when any cycle is selected, except for Express Wash and Rinse Only.	Heat Dry: 0:10 to 0:50 Extended Heat Dry (includes Heat Dry time): 0:40 to 1:20	0
Sani Rinse	ProWash™ Normal	Sanitizes dishes and glassware in accordance with NSF International NSF/ANSI Standard 184 for Residential Dishwashers. Certified residential dishwashers are not intended for licensed food establishments. Only sanitizing cycles have been designed to meet the requirements of the NSF/ANSI 184 performance standard for soil removal and for sanitization efficacy. There is no intention, either directly or indirectly, that all cycles on a NSF/ANSI 184 certified dishwasher meet the NSF/ANSI 184 performance standard for soil removal and for sanitization efficacy. The Sani Rinse indicator glows at the end of the cycle if the Sani Rinse option was successfully completed. If the indicator does not activate, it is probably due to the cycle being interrupted.	0:00 to 2:20	1.2 to 6.2 (4.8 to 23.3)



2-4-8 Hr. Delay	Runs the dishwasher at a later time or during off-peak electrical hours. Select a wash cycle and options. Touch the Delay keypad. Touch START/RESUME. Close the door firmly. NOTE: Anytime the door is opened (such as, to add a dish), the Start/Resume keypad must be touched again to resume the delay countdown.	Available with any cycle	Delays the start of a cycle to the specified time.	0
Control Lock Hold 3 Sec	Use the Control Lock option to avoid unintended use of dishwasher between cycles, or cycle and option changes during a cycle. To turn on Control Lock, touch and hold CONTROL LOCK for 3 seconds. Control Lock light will stay on for a short time, indicating that it is activated. When the Lock indicator is lit, all keypad selections are disabled. If you touch any keypad selection while your dishwasher is locked, the light flashes three times. The dishwasher door can still be opened/closed while the controls are locked. To turn off Control Lock, touch and hold CONTROL LOCK for 3 seconds. Control Lock light turns off.			
CONTROL		PURPOSE		COMMENTS
Start RESUME	To start or resume a wash cycle.	If the door is opened during a cycle or the power is interrupted, the Start/Resume indicator flashes. Cycle will not resume until the door is closed and Start is touched.		
Cancel DRAIN	To cancel a wash cycle after it has been started	Close the door firmly. Touch and hold CANCEL/DRAIN for 3 seconds. The dishwasher starts a 2-minute drain (if needed). Let dishwasher drain completely.		
Hi-Temp Wash Sound On/Off Hold 3 Sec	To turn the audible tones on or off.	Touch and hold HI-TEMP WASH for 3 seconds to turn the audible tones on or off. Only audible tones for confirming keypad touches can be turned on/off. Important audible tones, such as indicating a cycle has been interrupted, cannot be deactivated.		
Washing Drying Clean Sanitized ■ ■ ■ ■	To indicate the status of the cycle.	The display will indicate cycle progress such as Washing, Drying, Clean, and Sanitized. The cycle has completed when the Clean light is lit. If you select the Sani Rinse option, when the cycle is finished, the Sanitized indicator glows. If the dishwasher did not properly sanitize your dishes, the Sanitized indicator flashes at the end of the cycle. This can happen if the cycle is interrupted or if water could not be heated to required temperature. The light goes off when you open and close door or touch CANCEL.		

DISHWASHER CARE

Cleaning the Exterior

Clean the exterior of the dishwasher with only a soft, damp cloth, and mild detergent. If your dishwasher has a stainless steel exterior, it may have a coating that is resistant to fingerprints. Avoid using abrasive cleaning products on the exterior of the dishwasher.

Cleaning and Maintaining the Interior

Many detergents may leave white spots or a white residue on dishware and on the interior of the dishwasher. Over time this residue can become unsightly and could affect dishwasher performance. Use of a dishwasher cleaning product, such as affresh Dishwasher Cleaner, can help to remove the residue. Monthly use of affresh Dishwasher Cleaner is recommended to help maintain the dishwasher. Follow package directions.

NOTE: KitchenAid recommends the use of high-quality, premeasured detergent tablets or packs and the use of rinse aid for dishwasher cleaning and daily care.

If you have a drain air gap, check and clean it if the dishwasher isn't draining well.

To Reduce Risk of Property Damage During Vacation or Extended Time Without Use:

When you will not be using the dishwasher during the summer months, turn off the water and power supply to the dishwasher.

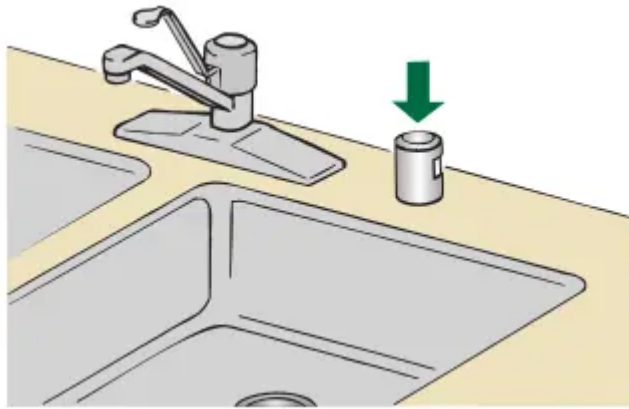

Make sure the water supply lines are protected against freezing conditions. Ice formations in the supply lines can increase water pressure and cause damage to your dishwasher or home. Damage from freezing is not covered by the warranty.

When storing your dishwasher in the winter, avoid water damage by having your dishwasher winterized by authorized service personnel.

TROUBLESHOOTING

The Clean light is flashing

Check the following:

- Was the cycle interrupted? Touch START/RESUME and close the door within 4 seconds.
- Is the overfill protection float able to move up and down freely? Press down to release.
- Be sure the water supply is turned on to the dishwasher. (This is very important following the new installation of your dishwasher.)
- Check for suds in the dishwasher. For more information on suds, see the “Dishwasher does not clean completely” section.

Dishes do not dry completely

NOTE: Plastic and items with nonstick surfaces are difficult to dry because they have a porous surface which tends to collect water droplets. Towel drying may be necessary.

Use of rinse aid along with the Heat Dry option is needed for proper drying.

Proper loading of items can affect drying.

For improved results, place items on the more slanted side of the rack.

Glasses and cups with concave bottoms hold water. This water may spill onto other items when you are unloading the dishwasher.

Unload the bottom rack first.

Spotting/Filming

NOTES:

Liquid rinse aid is necessary for drying and to reduce spotting.

Use the correct amount of detergent. If using powder or liquid/gel products, use package instructions.

Confirm that the cloudiness is removable by soaking the item in white vinegar for 5 minutes. If the cloudiness disappears, it is due to hard water. Adjust the amount of detergent and rinse aid. See the "Dishwasher Care" section. If it does not come clear, it is due to etching.

Be sure the incoming water temperature is set at 120°F (49°C).

Try using the Hi-Temp Wash or Sani Rinse option.

To remove spotting, see the "Dishwasher Care" section.

Dishwasher does not clean completely

Be sure the dishwasher is loaded correctly. Improper loading can greatly decrease the washing performance. See the "Operating Your Dishwasher" section.

Check filter to ensure it is properly installed. Ensure the water intake screen on the floor of the dishwasher is not plugged with food or debris. Clean if required.

Select the proper cycle for the type of soils. The ProWash cycle can be used for tougher loads.

Be sure the incoming water temperature is at least 120°F (49°C).

Use the proper amount of fresh detergent. More detergent is needed for heavier-soiled loads and hard water conditions.

Scrape food from dishes prior to loading (do not prerinse).

If foam or suds are detected by the dishwasher sensing system, the dishwasher may not operate properly or may not fill with water.

Suds can come from:

- Using the incorrect type of detergent, such as laundry detergent, hand soap, or dish detergent for hand-washing dishes.
- Not replacing the rinse aid dispenser cap after filling (or refilling) the rinse aid dispenser.
- Using an excessive amount of dishwasher detergent.

Warning

This content is compiled from multiple sources and is provided for reference purposes only. It may not be complete or fully applicable to all situations. If you are unable to resolve your issue, please contact the product manufacturer or an authorized service provider for official support.

