

## Installation

This dryer must be installed by a qualified technician. The installer is responsible for connecting the dryer to the main power while observing the relevant safety regulations of your area.

### What's included

Make sure all the parts are included in the product package. If you have a problem with the dryer or the parts, contact a local Samsung customer center or the retailer.

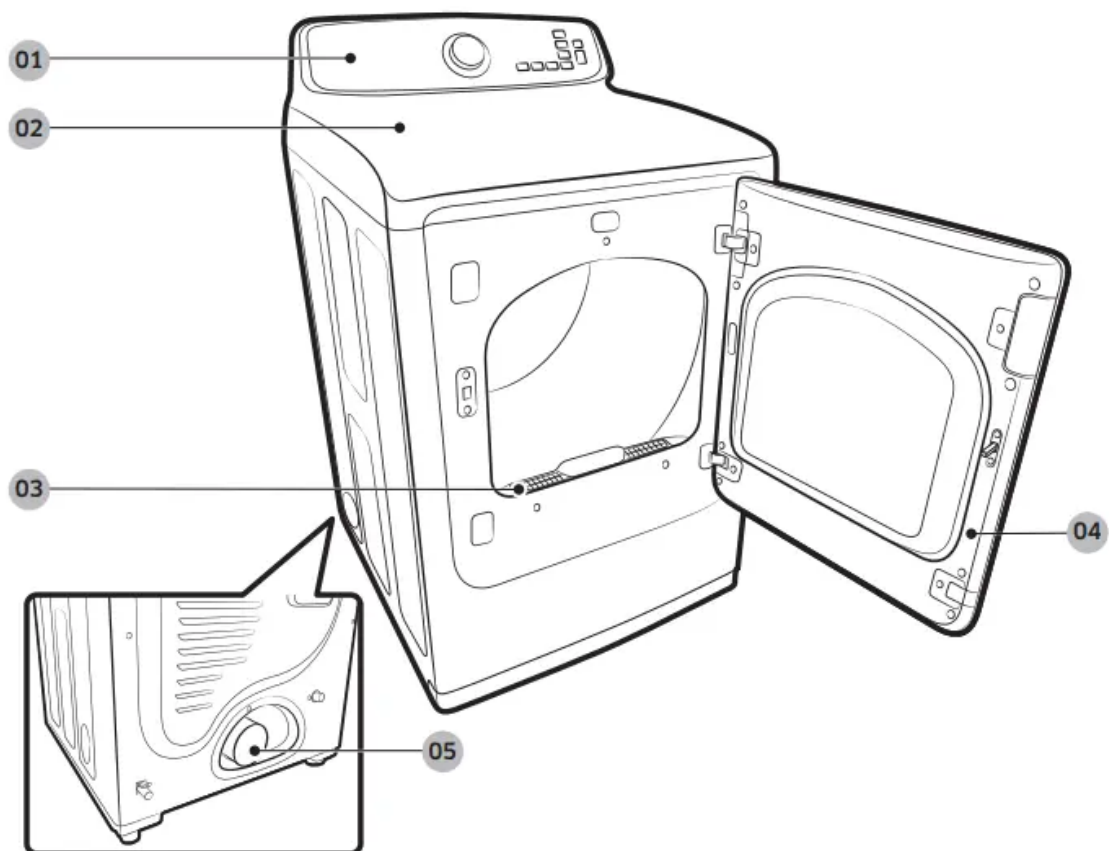

### Dryer at a glance

- 01 Control panel
- 02 Worktop
- 03 Filter
- 04 Door
- 05 Exhaust duct

### Accessories & tools

## Provided accessories



Y connector



Water hose  
(Canadian elec.  
models only)



Short water hose

## Required tools



Pliers



Cutting knife



Pipe wrench (gas  
models only)



Nut driver



Level



Philips screwdriver



Duct tape



Wrench



LPG-safe compound  
or Teflon Tape (for  
gas installation)

**WARNING:** Packing materials can be dangerous to children. Keep all packing materials (plastic bags, polystyrene, etc.) out of children's reach.

## Step-by-step installation

Make sure you have a qualified technician install the dryer. Step by step installation instructions start below.

- Do not remove the protective film on the door before completing the product installation. If you remove the protective film before the installation is complete, the door may get scratched or damaged during installation.
- Make sure the installation location allows enough space for the dryer door to be fully open.

### STEP 1 Install the exhaust system

1. Select a location and move the dryer to the site. For easy access, we recommend you install the dryer in the same location as your washer.

2. To change the door direction, see “Switching the door position” .
3. Install the exhaust system as instructed in the “Exhaust ducting guide” section.

**CAUTION:** Before installing your dryer, remove the packing in the duct.

**NOTE:**

- To move the dryer easily, lay two of the carton cushion-from the packaging on the floor. Tip the dryer on its side so it lies across both cushion-tops. Push the dryer so that it is near its final location, and then set the dryer upright.
- Secure room around the dryer to facilitate ducting and wiring.

## **STEP 2 Connect the gas line**

Before connecting the gas line, make sure you have read the “Gas requirements” section on page 16.

1. Remove the protective cap from the gas pipe.
2. Apply an LPG (Liquefied Petroleum Gas)-safe compound or 1.5 wraps of Teflon tape to all threaded connections.
3. Connect the gas supply to the dryer. An additional fitting is required to connect the 3/4” (1.9 cm) female thread end of a flexible connector to the 3/8” (1 cm) male threaded end on the dryer. Tighten up the fitting over all threads.
4. Turn on the gas supply, and check for any leaks using a soap solution. If a leak is found, tighten the connections and try again. Do not use an open flame to check for gas leaks.

## **STEP 3 Connect the electrical wiring**

First, read through the “Electrical requirements” section, and follow these steps

### **3-wire system**

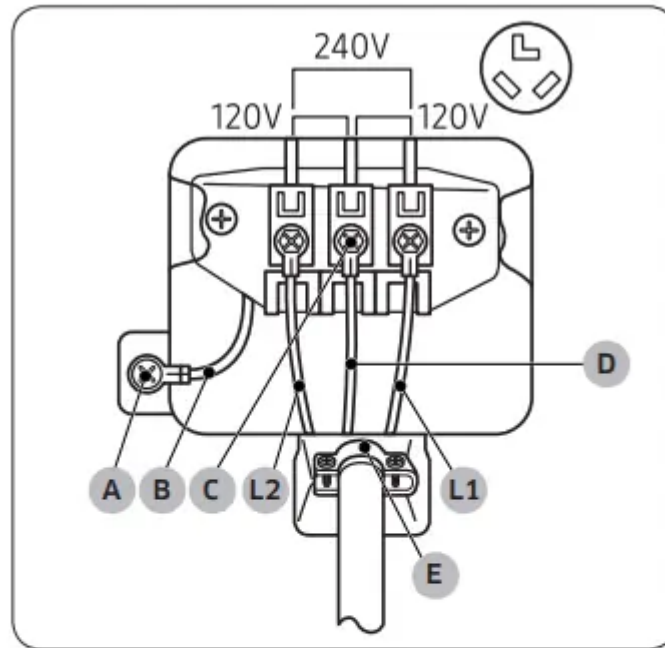

- A. External ground connector
- B. Neutral grounding wire (white)
- C. Center silver-colored terminal block screw
- D. Neutral wire (white or center wire)
- E.  $\frac{3}{4}$ " (1.9 cm) UL-listed strain relief

1. Loosen or remove the center terminal block.
2. Connect the neutral wire (white or center wire) of the power cable to the center, silver-colored terminal screw of the terminal block. Tighten the screws.
3. Connect the other wires to outer terminal block screws. Tighten the screws.
4. Tighten the strain relief screws.
5. Insert the terminal block cover into the rear panel of the dryer. Then, secure the cover with a hold-down screw.

**CAUTION:**

- To convert from the 4-wire system to 3-wire system, connect the ground strap to the terminal block support to ground the dryer frame to the neutral conductor.
- Ring-type terminals are recommended. If using strap terminals, make sure they are tightened.
- Before Installing the Dryer, confirm 240 V is present between L1 and L2 at the power receptacle. If the Voltage is low, it may not dry properly. Review the "Electrical requirements" section on page 17 if needed.

## 4-wire system

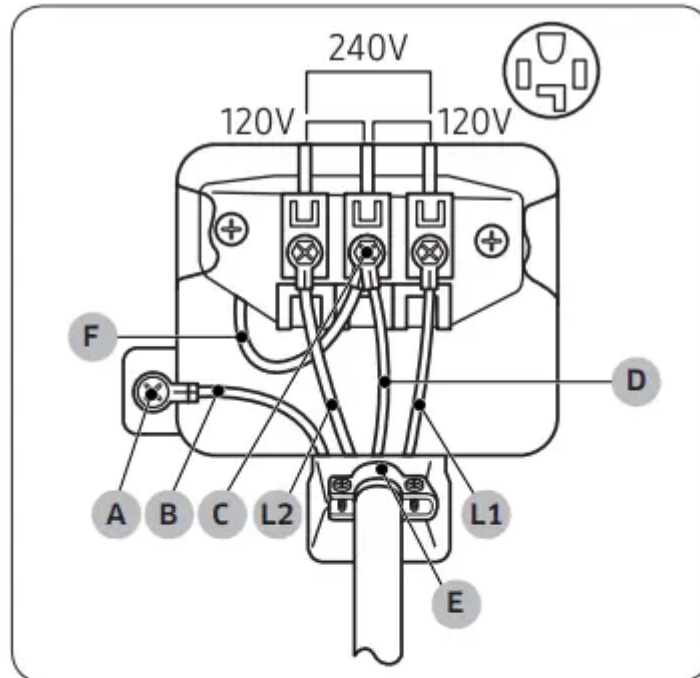

- A. External ground connector
- B. Neutral grounding wire (white)
- C. Center silver-colored terminal block screw
- D. Neutral wire (white or center wire)
- E.  $\frac{3}{4}$ " (1.9 cm) UL-listed strain relief
- F. Neutral wire (white or center wire)

1. Remove the external ground connector's screw and connect the ground wire (green or unwrapped) of the power cable to the screw.

### CAUTION:

- To connect the ground wire to the neutral position without through contact A (cabinet ground), contact a technician. This is not user serviceable.
- Ring-type terminals are recommended. If using strap terminals, make sure they are tightened.

2. Loosen or remove the screws from the center terminal block.

3. Connect the neutral wire (white or center wire) and ground wire (white) to the center screw of the terminal block. Tighten the screw.

4. Connect the other wires to the outer terminal block screws. Tighten the screws.

5. Tighten the strain relief screws.

6. Insert the tab of the terminal block cover into the rear slot of the dryer. Secure the cover with a hold-down screw.

**WARNING:**

- All U.S. models are designed for a 3-wire system connection. The dryer frame is grounded to the neutral conductor at the terminal block. A 4-wire system connection is required for new or remodeled construction, mobile homes, or if local codes do not permit grounding through neutral. If you use the 4-wire system, you cannot ground the dryer frame to the neutral conductor at the terminal block.
- Remove the terminal block cover plate. Insert the power cord with a UL-listed strain relief through the hole provided in the cabinet near the terminal block.
- A strain relief must be used. Do not loosen the nuts already installed on the terminal block. Be sure they are tight. Use a 3/8" (1 cm) deep well socket.

**STEP 4 Connect the water hose**

The dryer must be connected to a cold water tap using the provided water hoses.

1. Close the cold water tap. If you have a washer's cold water hose attached to the cold water tap, unscrew and remove the hose. Then, connect the female end of the Y-connector to the cold water tap.
2. Connect the straight end of the water hose to the Y-connector.
3. Using pliers, tighten the coupling an additional two-thirds turn. Do not overtighten because the coupling may be damaged.
4. Connect the angled end of the water hose to the filling valve at the bottom of the rear frame. Turn the coupling manually until it is tight.
5. Using pliers, tighten the coupling an additional two-thirds turn. Do not overtighten because the coupling may be damaged.
6. If you detached the cold water hose from your washer, attach the hose to the open end of the Y-connector, tighten the coupling by hand until it is tight, and then, using a pliers, tighten an additional two-thirds turn.
7. Open the cold water tap, and then check for any leaks.

If the Y-connector cannot be directly connected to the cold water tap, use the short hose. See the "Using the short hose as an extension" section on page 26.

Using the short hose as an extension

1. Close the cold water tap. If you have a washer's cold water hose attached to the cold water tap, unscrew and remove the hose. Then, connect the short hose (B) to the cold water tap. Turn the coupling by hand until it is tight.



2. Using pliers, tighten the coupling an additional two-thirds turn. Do not overtighten because the coupling may be damaged.
3. Connect the Y-connector (A) to the brass male end of the short hose. Turn the coupling by hand until it is tight.
4. Using pliers, tighten the coupling an additional two-thirds turn. Do not overtighten because the coupling may be damaged.
5. Connect the angled end of the water hoses (C) to the filling valve at the bottom of the rear frame. Turn the coupling manually until it is tight.
6. Using pliers, tighten the coupling an additional two-thirds turn. Do not overtighten because the coupling may be damaged.
7. If you detached the cold water hose from your washer, attach the hose to the free end of the Y-connector, tighten the coupling by hand until it is tight, and then, using a pliers, tighten an additional two-thirds turn.
8. Open the cold water tap, and then check for any leaks.

### **STEP 5 Level the dryer**

To ensure optimal performance, the dryer must be level.



1. Using a level (A), check if the dryer is level side to side and then front to back. If the dryer is not level, adjust the leveling feet (B) at the bottom of the dryer. Then, check if the dryer is level again.

#### **NOTE**

- To set the dryer to the same height as your washer, fully retract (A) the leveling feet by turning them counterclockwise, then loosen (B) the feet by turning them clockwise. Once the dryer is the same height as the washer, follow the directions above to level the dryer.
- Adjust the leveling feet only as much as necessary to level the dryer. Extending the leveling feet more than necessary can cause the dryer to vibrate.

### **STEP 6 Power on (Gas models)**

Make sure all gas connections, the exhaust line, and all wiring is connected correctly. Then, plug the power cord into a power source and check the dryer's installation and operation using the final checklist in Step 7 below.

### **STEP 7 Final check**

When installation is complete, confirm that:

- The dryer is plugged into an electrical outlet and grounded properly.
- The exhaust ductwork is connected, and the joints are taped.
- You have used rigid or stiff-walled flexible metal duct material, not plastic flexible duct.
- The dryer is level and is sitting firmly on the floor.
- The dryer starts, runs, heats, and shuts off properly.

#### **For gas models:**

- The gas is supplied properly with no leaks.

**CAUTION:** The burner may not ignite initially due to air in the gas line. Allowing your dryer to operate on a heat setting will purge the line. If the gas does not ignite within 5 minutes, turn your dryer off and wait 5 minutes. Be sure the gas supply to your dryer has been turned on. To confirm gas ignition, check the exhaust for heat.

### **Vent blockage test**

After the dryer is installed, start the Vent Blockage Test to check if the duct system is properly installed. The Vent Blockage Test automatically detects the status of the ducts and reports any blockage or problems. Proper ducting can reduce drying time and save energy.

**NOTE:** The Vent Blockage Test must run when the dryer is cool. If the dryer warms up after the installation check, run the AIR FLUFF cycle for several minutes to reduce its internal temperature.

## Running the vent blockage test

1. Make sure the drum is empty, and then close the door. (If there are any clothes or other items in the drum, the test will not give accurate results.)
2. Press the Power button to turn the dryer on, then simultaneously press and hold the Adjust Time  $\wedge$  and Dryness buttons for 3 seconds. "InS or In" appears in the dryer's display. (If you have started other procedures before the Vent Blockage Test, the dryer will not enter the Vent Blockage Test mode.)
3. . Press the START/PAUSE button. The Vent Blockage Test starts immediately. During the test, the number indicator makes a circle in 6 clockwise steps. The test takes about 2 minutes. Do not open the door during the test.
4. After 2 minutes, when the test is complete, the results is displayed and the dryer sounds a tone. If status of the duct system is normal, "End or 0" appears and the dryer sounds a completion tone.

If the duct system cannot exhaust properly, the check code appears, and the dryer sounds an alarm tone. For description about the code, see the "Installation check codes" section on page 30

If there are any other problems, an information code appears in the display. For description about the code, see the "Information codes" section on page 49

- To stop or cancel the Vent Blockage Test, press the Power button to turn off your dryer.

- The results remain on the display for about 5 minutes and then automatically turn off. You can turn the results off immediately by pressing the Power button.

### NOTE:

- During or after the test, the internal drum is hot. Use caution to prevent burns. The Vent Blockage Test is used to check for problems to the current duct system when the dryer is installed for the first time.
- If the test result displays check code (the duct system is blocked ), refer to the "Ducting requirements" section on page 14 and the "Exhaust ducting guide" section below, and then take proper measures to correct any problems. If the test is suspended, it could result in incorrect results. Follow the proper procedures when testing the dryer
- Even if the test result is normal ("End or 0"), the duct system could be blocked slightly. Properly install all duct work according to the installation instructions in this manual.

## Exhaust ducting guide

### Ducting

1. Make sure the dryer is installed properly so the air exhausts freely.

2. Use 4-inch rigid metal ducts. Tape all joints including the dryer connection. Never use lint-trapping screws.
3. To facilitate the exhaust, keep the ducts as straight as possible.

### **Cleaning**

Clean all old ducts before installing the dryer, and make sure the vent flap opens and closes freely. We recommend that you to clean the exhaust system annually or on a regular basis.

### **WARNING:**

- To prevent fire, do not use plastic, thin-foil, or non-metal flexible ducts of any kind.
- Do not use a poor exhaust system because it slows down the dryer's performance.
- Do not use excessively long ducts that have multiple elbows.
- Do not use crushed or clogged venting or ducts.

### **Switching the door position**

To reverse the direction of the door, we recommend that you contact a qualified technician. It is recommended to put a soft rug on the floor to prevent scratches on the door.

1. Put a soft rug on the floor to rest the door on after you have removed it. This will prevent the door from being scratched.
2. Unplug the power cord of the dryer.
3. Remove the four hinge screws from the door, and then remove the door by lifting it up slightly.
4. Remove the two screws from the lever holder, and then remove the holder cover.
5. Put the lever holder on the other side as shown, and then tighten the screws. Install the holder cover on the opposite side as shown.
6. Use a flat-head screwdriver to remove the two hinge covers from the original side. Install the hinge covers on the opposite side as shown.
7. Locate and remove the 10 screws as shown. Note that screw B (x2) is longer than the others.
8. Remove the glass holder, and switch the positions of:
  - a. the hinge cover and the door handle.
  - b. the hinge holder and the glass-guide holder
9. Remove the door lever, and then move it to the other side as shown.
10. Remove the hole cover (C), and then insert and tighten the glass holder using the removed 10 screws.
11. Install the hole cover on the opposite side as shown.

**12.** Reinstall the door on the front frame, and then carefully insert and tighten the 4 hinge screws.

## Before you start

Here are a few things you should know before starting your dryer.

### Sort and load

- Put one wash load in the dryer at a time.
- Do not mix heavy and lightweight items together.
- To improve drying efficiency for one or two items, add a dry towel to the load.
- For best results, untangle items before inserting them into the dryer.
- Tangled items may degrade the drying efficiency or cause the door to open.
- Overloading reduces the tumbling performance, resulting in uneven drying and wrinkling.
- Unless recommended on the care label, do not dry woolens or fiberglass items.
- Avoid drying unwashed items.
- Do not dry items soiled with oil, alcohol, gasoline, etc.

### Functional prerequisite

#### Lint filter

To prevent a risk of fire, make sure to clean the lint filter before or after every load.

1. Turn off the dryer.
2. Open the door and pull out the lint filter (A) from inside the drum.
3. Remove the lint, and then clean the lint filter.
4. Reinsert the lint filter, and then close the door.

#### CAUTION:

- Do not operate the dryer without the lint filter in place.
- Do not use a damaged or broken lint filter. This may reduce performance and/or cause fire.

## Operations

**WARNING:** To reduce the risk of fire, electric shock, or injury to persons, read the “Safety information” before operating this appliance.

## Feature panel

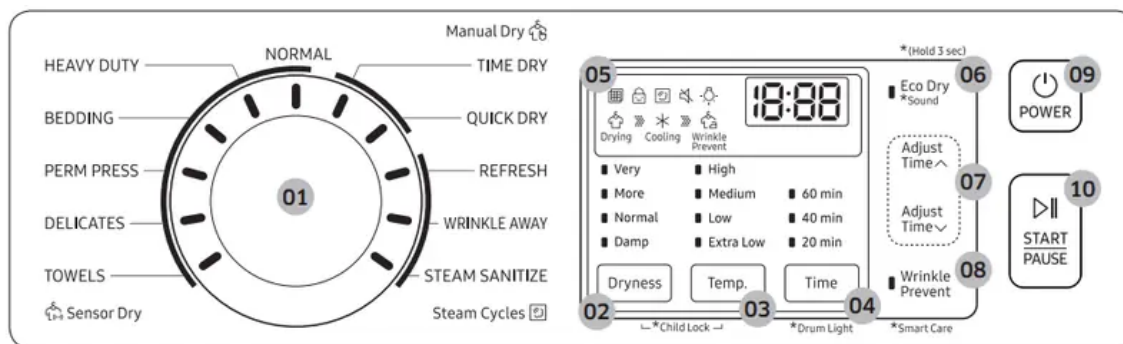

### 01. Cycle Selector

Turn the Cycle Selector to select a desired cycle. When a cycle is selected, the cycle indicator lights up.

- **Steam Cycles:** The dryer sprays water into the drum to deodorize clothes and reduce static electricity and wrinkles.
- **Manual Dry:** The drying time is fixed.

### 02. Dryness

Press to select a dry level. You can select from 5 different options (Less to More). Please refer to following recommendations to select the appropriate dryness.

- Larger or bulkier loads may require Very Dry or More Dry for complete dryness.
- Damp Dry is designed to partially dry items. Use for items that lay flat or hang to dry.

**NOTE:** This option is not available with REFRESH, WRINKLE AWAY, STEAM SANITIZE, TIME DRY and QUICK DRY

### 03. Temp.

Temperature can only be adjusted in TIME DRY cycle. Press to change the temperature of the current cycle. You can select from 4 different options. Please select the appropriate temperature depending on the items in the load.

- **High:** For sturdy cottons or those labeled Tumble Dry.
- **Medium:** For permanent press, synthetics, lightweight cottons, or items labeled Tumble Dry Medium.
- **Low:** For heat sensitive items labeled Tumble Dry Low or Tumble Dry Warm. Provides the lowest heated drying temperature possible.
- **Extra Low:** Provides the lowest heated drying temperature possible.

### 04. Time

Press to adjust the drying time for the Manual Dry cycles. This is not available with the Sensor Dry cycles because the dryer determines the drying time by sensing the current moisture level of the load.

#### **05. Digital Graphic Display**

Displays all cycle information, including the cycle time, information code, and operating status.

#### **06. Eco Dry**

This function is available with NORMAL and TIME DRY. With the Eco Dry activated, drying takes a longer time but the power consumption is reduced.

The drying time can be extended by up to 3 times depending on the temperature and load. The Eco Dry function is enabled by default.

#### **07. Adjust Time**

You can change the set time in the Manual Dry cycles (TIME DRY, QUICK DRY) and WRINKLE AWAY. To change the cycle time, press  $\wedge$  or  $\vee$  until the desired time is displayed.

#### **08. Wrinkle Prevent**

Wrinkle Prevent provides approximately 180 minutes of intermittent tumbling in unheated air at the end of the cycle to reduce wrinkling. Press Wrinkle Prevent to activate this feature.

The load is dry, and can be removed at any time during the Wrinkle Prevent cycle.

#### **09. POWER**





Press to turn on/turn off the dryer.

#### **10. START/PAUSE**

Press to start or stop operation.

**NOTE** Extremely tangled items finished by the washer may degrade the drying efficiency or cause the door to open. We recommend that you untangle the items before drying.

#### **Icon description**

	Filter Check	This icon displays after every load as a reminder to clean the lint filter. Clean the lint filter before every cycle and make sure the filter is properly inserted before starting a cycle.
	Steam	This icon appears when the dryer is in steam process. The dryer sprays water into the drum to deodorize clothes and reduce static electricity and wrinkles.
	Child Lock	This icon indicates that Child Lock is on. For more information on Child Lock, see page 43.
	Sound On/Off	This icon indicates that the sound is off. For more information on Sound On/Off, see page 43.
	Drum Light	This icon indicates that Drum Light is on. For more information on Drum Light, see page 43.

## Simple steps to start

1. Press **POWER** to turn on the dryer.
2. Turn the **Cycle Selector** to select a cycle.
3. Change the cycle settings (**Dryness** and **Time**) as necessary.
4. Optionally, you can activate options available by pressing the relevant button (**Eco Dry** and/or **Wrinkle Prevent**).
5. Press **START/PAUSE**. The dryer indicator turns on with an estimated cycle time on the display.

## To change the cycle during operation

1. Press Start/Pause (Hold to Start) to stop operation.
2. Select a different cycle, and repeat steps 2-4 above if necessary.
3. Press and hold Start/Pause (Hold to Start) again to start the new cycle.

## Special features

### Child Lock

Child Lock prevents children from playing with the dryer. When Child Lock is activated, all buttons except for the Power button are disabled.

To activate/deactivate Child Lock, simultaneously press and hold Dryness and Temp. for seconds.

**NOTE:** Once Child Lock is activated, it will remain active even after you restart the dryer. If other buttons, except for the Power button, do not respond, check the Child Lock indicator. If the indicator is on, follow the instructions above to turn Child Lock off.

### Drum Light

To turn on the drum light while the dryer is running, press and hold **Time** for 3 seconds.

#### **NOTE**

After 5 minutes of inactivity, the drum light automatically turns off.

#### **Sound On/Off**

To turn off the dryer's notification beeps and melodies, press and hold **Eco Dry** for 3 seconds.

To unmute the dryer, press and hold **Dryness** again for 3 seconds.

#### **NOTE**

This function remains active even after you restart the dryer.

#### **Smart Care**

If the dryer displays an information code, you can use Smart Care to check the status of the dryer on a smartphone. To use Smart Care, you must have the Samsung Smart Care app installed on your smartphone

#### **NOTE**

Smart Care is optimized for Samsung Galaxy and Apple iPhones. (Not compatible with some models).

Download the Samsung Smart Care app from the Google Play Store or Apple App store (Search word: "**Samsung Smart Washer/Dryer**"), and install it on your smartphone.

If an information code appears on the dryer, follow these steps:

1. Press and hold **Wrinkle Prevent** for 3 seconds to activate Smart Care. The Smart Care indicator turns on.
2. Open the Smart Care app on your smartphone.
3. Put the smartphone's camera close to the display of the dryer. The app automatically recognizes the information code, and displays suggestions on your smartphone.
4. If the smartphone fails to recognize the information code more than twice, type the information code manually into the Smart Care app.

#### **CAUTION**

- If light is reflected on the display of the dryer, the smartphone may not recognize the information code.
- If you hold the smartphone at an angle to the dryer's display, the dryer may not recognize the information code.

For best results, hold the smartphone so that the front of the panel and the smartphone are parallel or nearly parallel.

- After you use this function, the dryer will delete the record of the information code from its code log.

## Maintenance

Keep the dryer clean for best performance and to lengthen its life cycle.

**WARNING:** Certain internal parts are intentionally not grounded and may present a risk of electric shock only during servicing. Service Personnel - Do not contact the following parts while the appliance is energized: Control board and inlet valve.

### Cleaning

#### Feature panel

- Clean with a soft, damp cloth. Do not use abrasive substances.
- Do not spray liquid cleaning agents directly onto the dryer display.
- Some laundry pre-treatment soil and stain removers may damage the control panel.
- When using liquid cleaning agents, apply them to the cleaning cloth. Do not apply them directly to the dryer. Wipe up any spills or overspray immediately.

#### Tumbler

- Remove any stains from the tumbler with an all-purpose cleaner.
- Tumble old towels or rags to remove any remaining stains or cleaning substances. Stains may be still visible, but will not affect subsequent loads.

#### Powder coat tumbler

To clean the powder coat tumbler, use a damp cloth with a mild, non-abrasive cleaner suitable for easily marred surfaces. Remove cleaner residue and dry with a clean cloth.

#### Dryer exterior

- Clean with a soft, damp cloth. Do not use abrasive substances.
- Protect the surface from sharp objects.
- Do not place any heavy or sharp objects or a detergent container on the dryer. They can scratch or damage the top cover of the dryer.
- The dryer has a high-gloss finish on the entire surface. Be careful not to scratch or damage the surface.

#### Exhaust system

- Check and clean the exhaust system on a regular basis to maintain optimum performance.
- The external exhaust hood must be cleaned frequently to ensure proper air flow.

# Troubleshooting

## Checkpoints

If the dryer operates abnormally, first check the list of problems in the table below and try the suggested actions.

Problem	Action
<b>Does not run.</b>	<ul style="list-style-type: none"><li>• Make sure the door is latched shut.</li><li>• Make sure the power cord is plugged into a live electrical outlet.</li><li>• Check your home's circuit breakers or fuses.</li><li>• Press or tap <b>START/PAUSE</b> again if the door is opened during a cycle.</li><li>• Clean the lint filter.</li></ul>
<b>Does not heat.</b>	<ul style="list-style-type: none"><li>• Check your home's circuit breakers or fuses.</li><li>• Some cycles do not require heat. Check the selected cycle again.</li><li>• For a gas dryer, make sure the gas supply is on.</li><li>• Clean the lint filter and exhaust duct.</li><li>• The dryer may have moved into the cool-down phase of the cycle.</li><li>• Turn off the Eco Dry option for the <b>NORMAL</b> or <b>TIME DRY</b> cycles. When the Eco Dry option is on, the dryer performs an air dry process in the beginning of the cycle to reduce energy consumption. The air dry process does not use heated air, so you may feel that the dryer is not being heated, but this is normal.</li></ul>



<p><b>Does not dry.</b></p>	<ul style="list-style-type: none"> <li>• Check all of the above, plus...</li> <li>• Make sure the exhaust hood outside your home can open and close freely.</li> <li>• Check the exhaust system for lint buildup. Ducting should be inspected and cleaned annually.</li> <li>• Use a 4" rigid metal exhaust duct.</li> <li>• Do not overload. 1 wash load = 1 dryer load.</li> <li>• Dry heavy items and light weight items separately.</li> <li>• Large, bulky items, such as blankets or comforters, may require repositioning to ensure even drying.</li> <li>• Make sure that your washer is draining properly and extracting adequate water from the load.</li> <li>• The load may be too small to tumble properly. Add a few towels and restart the dryer.</li> <li>• The load may be too large to tumble properly. Remove some items and restart the dryer.</li> <li>• Clean the lint filter.</li> </ul>
<p><b>Is noisy.</b></p>	<ul style="list-style-type: none"> <li>• Check the load for objects such as coins, loose buttons, nails, etc. Remove promptly.</li> <li>• It is normal to hear the dryer gas valve or heating element cycle on and off during the drying cycle.</li> <li>• Make sure the dryer is leveled properly as outlined in the installation instructions.</li> <li>• It is normal for the dryer to hum due to the high velocity of air moving through the dryer drum, fan, or exhaust system.</li> </ul>
<p><b>Dries unevenly.</b></p>	<ul style="list-style-type: none"> <li>• Seams, pockets, and other similarly heavy areas may not be completely dry when the rest of the load has reached the selected dryness level. This is normal. You can choose a higher dryness level or a cycle that involves a higher dryness level.</li> <li>• If one heavy item is dried with a light weight load, such as one towel with sheets, it is possible that the heavy item will not be completely dry when the rest of the load has reached the selected dryness level.</li> </ul>



- For the best drying results, dry heavy items and light weight items separately.



<p><b>Has odors.</b></p>	<ul style="list-style-type: none"> <li>• Household odors from paint, varnish, strong cleaners, etc. may enter the dryer with the surrounding room air. This is normal as the dryer draws the air from the room, heats it, pulls it through the tumbler, and exhausts it outside.</li> <li>• When these odors linger in the air, completely ventilate the room before using the dryer.</li> <li>• Use a cycle featuring the Refresh function. If odors persist, wash and dry the item again.</li> </ul>
<p><b>Lint on clothes.</b></p>	<ul style="list-style-type: none"> <li>• Make sure the lint filter is cleaned before every load. For clothes that naturally build up lint, clean the filter during the cycle.</li> <li>• Some fabrics are lint producers (for example, a fuzzy white cotton towel) and they must be dried separately from clothes that are lint trappers (for example, a pair of black linen pants).</li> <li>• Divide larger loads into smaller loads for drying.</li> <li>• Check pockets thoroughly before drying, then dry clothes.</li> <li>• Remove lint inside the drum before drying.</li> </ul>
<p><b>Items still wrinkled after WRINKLE PREVENT (WRINKLE-CARE, WRINKLE RELEASE).</b></p>	<ul style="list-style-type: none"> <li>• Small loads of 1 to 4 items work best.</li> <li>• Load fewer items. Load similar-type items.</li> <li>• Take out the items immediately after drying is complete.</li> </ul>
<p><b>Water drips from the nozzle when STEAM CARE starts.</b></p>	<ul style="list-style-type: none"> <li>• This is steam condensation. The dripping water will stop after a short time.</li> </ul>
<p><b>Sprayed water is not visible during STEAM CARE.</b></p>	<ul style="list-style-type: none"> <li>• Sprayed water is difficult to see when the door is closed.</li> </ul>
<p><b>Extended time.</b></p>	<ul style="list-style-type: none"> <li>• Sensor Dry automatically senses the moisture in the load and shuts the dryer off when the selected dryness level is reached.</li> </ul> <p>The drying time can change according to the type and amount of laundry. See the cycle chart for reference.</p>



## Information codes

If the dryer fails to operate, you may see an information code on the display panel. To determine what you should do, check the list of codes in the table below, and then try the suggested actions

Code	Action
<b>dC</b>	<p>Operating the dryer with the door open.</p> <ul style="list-style-type: none"> <li>• Make sure the door is properly closed.</li> <li>• Make sure laundry is not caught in the door.</li> </ul>
<b>FC</b>	<p>Invalid power source frequency</p> <ul style="list-style-type: none"> <li>• Try restarting the cycle.</li> <li>• If this information code remains, contact a Samsung service center.</li> </ul>
<b>AC</b>	<p>Electronic control problem (Invalid Communication).</p> <ul style="list-style-type: none"> <li>• Contact a Samsung service center.</li> </ul>
<b>HC</b>	<p>High temperature heating check</p> <ul style="list-style-type: none"> <li>• Clean the lint filter.</li> <li>• If this information code remains, contact a Samsung service center.(enter the line test mode)</li> </ul>
<b>9C1</b>	<p>The electronic control needs to be checked.</p> <ul style="list-style-type: none"> <li>• Check if power is supplied properly.</li> <li>• If the information code remains, contact a Samsung service center.</li> </ul>
<b>tC</b>	<p>The Thermistor1 resistance is very low or high.</p> <ul style="list-style-type: none"> <li>• Check for a clogged lint screen</li> <li>• Check if the vent system is restricted.</li> <li>• If this information code remains, contact a Samsung service center.</li> </ul>
<b>tC5</b>	<p>The Thermistor2 resistance is very low or high.</p> <ul style="list-style-type: none"> <li>• Check for a clogged lint screen.</li> <li>• Check if the vent system is restricted.</li> </ul>



	<ul style="list-style-type: none"><li>• If this information code remains, contact a Samsung service center.</li></ul>
<b>dF</b>	<p>Incorrect door switch.</p> <ul style="list-style-type: none"><li>• Contact a Samsung service center.</li></ul>

**Warning**

This content is compiled from multiple sources and is provided for reference purposes only. It may not be complete or fully applicable to all situations. If you are unable to resolve your issue, please contact the product manufacturer or an authorized service provider for official support.

