

OPERATION

Operation Overview

Using the Appliance

Before the first wash, select the Cotton wash programme and add a half amount of the detergent. Start the appliance without laundry. This will remove possible residues and water from the drum that may have been left during manufacturing.

1. Sort laundry and load items.
 - Sort laundry by fabric type, soil level, colour and load size as needed. Open the door and load items into the appliance.
2. Add detergent or softener.
 - Add the proper amount of detergent to the detergent dispenser drawer. If desired, add bleach or fabric softener to the appropriate areas of the dispenser.
3. Turn on the appliance.
 - Press the Power button to turn on the appliance.
4. Choose the desired cycle.
 - Press the cycle button repeatedly or turn the cycle selector knob until the desired cycle is selected.
 - Now select a wash temperature and spin speed. Pay attention to a fabric care label of your clothes.
5. Begin cycle.
 - Press the Start/Pause button to begin the cycle. The appliance will agitate briefly without water to measure the weight of the load. If the Start/Pause button is not pressed within 15 minutes, the appliance will shut off and all settings will be lost.
6. End of cycle.
 - When the cycle is finished, a melody will sound. Immediately remove your clothing from the appliance to reduce wrinkling. Check around the door seal when removing the load for small items that may be caught in the seal.

Preparing the Laundry

Sort laundry for best washing results, and then prepare laundry according to the symbols on the care labels.





Sorting the Clothes

- For best washing results, sort your clothes according to a care label stating fabric type and washing temperature. Adjust the spin speed to wash them.
- Soil level (Heavy, Normal, Light): Separate clothes according to soil level. If possible, do not wash heavily soiled items with lightly soiled ones.
- Colour (White, Lights, Darks): Wash separately dark or dyed clothes from whites or light colours. Mixing dyed clothes with light clothes can result in dye transfer or discolouration of lighter clothes.
- Lint (Lint producers, Collectors): Wash separately lint producing fabrics from lint collecting fabrics. Lint producers can result in pilling and linting on the lint collectors.

Checking the Fabric Care Label

Symbols on the care labels

The symbols tell you about the fabric content of your clothes and how it should be washed.

Symbol	Wash / Fabric type
	<ul style="list-style-type: none">• Normal Wash• Cotton, Mixed Fabrics
	<ul style="list-style-type: none">• Easy Care• Synthetic, Mixed Fabrics
	<ul style="list-style-type: none">• Special Delicate Wash• Delicates
	<ul style="list-style-type: none">• Hand Wash Only• Wool, Silk
	<ul style="list-style-type: none">• Do not wash

NOTE

- The dashes under the symbol give you information about the type of fabric and the maximum allowance of mechanical stress.

Checking the Clothes before

Loading

- Combine large and small items in a load. Load large items first. Large items should not be more than half of total load.
- Do not wash single small items. Add 1-2 similar items to the load to prevent an out-of-balance load.

- Make sure to empty all pockets. Items such as nails, hair clips, matches, pens, coins and keys can damage both your appliance and clothes.

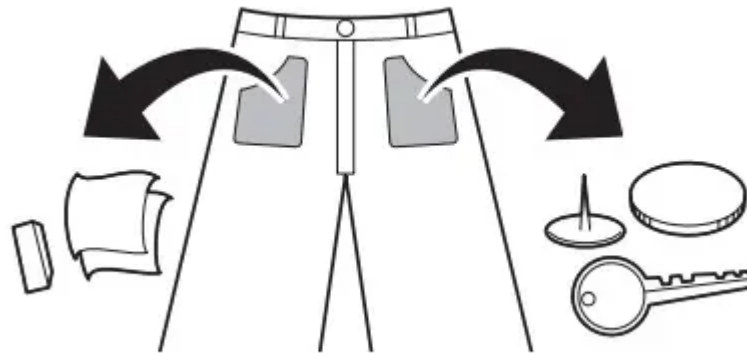

- Wash delicates (stockings, underwired bras) in a wash net.
- Close zippers, hooks and strings to make sure that these items do not snag other clothes.
- Pre-treat dirt and stains by saturating the dirt and stains with dissolved detergent and brushing them in order to remove dirt.
- Check the folds of the flexible gasket (gray) and remove any small items.

CAUTION

- Check if the laundry gets stuck between the door and the seal, otherwise the laundry may get damaged while washing.

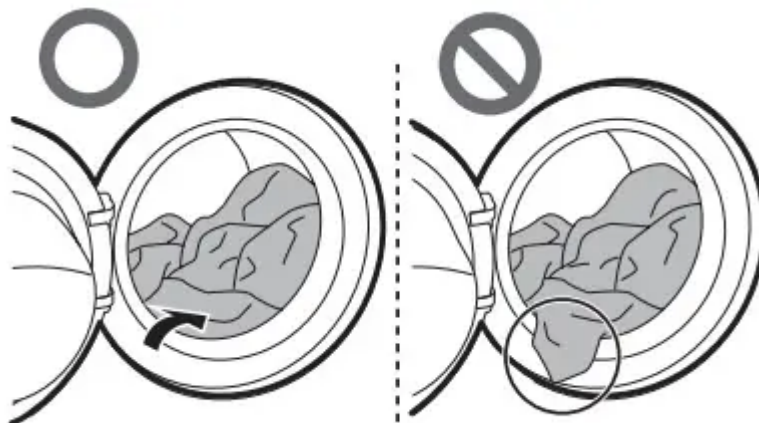

- Remove items from the flexible gasket to prevent clothing and door seal damage.

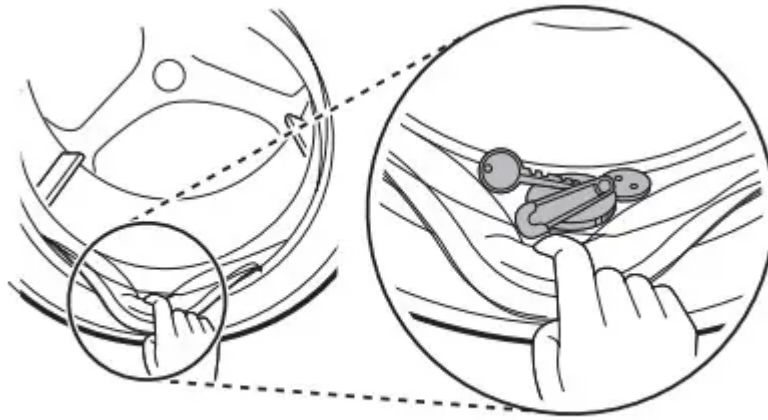

Adding Detergents and Softeners



Detergent Dosage

- Detergent should be used according to the instruction of the detergent manufacturer and selected according to type, colour, soiling of the fabric and the washing temperature.
- Reduce the amount of detergent if too many suds are formed.
- Too much detergent results in excessive suds which cause poor washing.
- When you use liquid detergent, follow the guidelines provided by the detergent manufacturer.
- You can pour liquid detergent directly into the main detergent drawer if you are starting the wash cycle immediately.
- Do not use liquid detergent if you are using Delay End function, or if you have selected Pre Wash option, as the liquid may harden.
- Detergent usage may need to be adjusted for water temperature, water hardness, size and soil level of the laundry. For best results, avoid oversudsing.
- Refer to the label of the clothes, before choosing the detergent and water temperature.
- Use only suitable detergents for the respective type of clothing:
 - Liquid detergent is often designed for special applications, e.g. for coloured fabric, wool, delicate or dark laundry.
 - Powdered detergent is suitable for all types of fabric.
 - For better washing results of white and pale clothes, use powdered detergent with bleach.
 - Detergent is dispensed from the dispenser at the beginning of the wash cycle.

NOTE

- Do not let the detergent harden. Doing so may lead to blockages, poor rinse performance or odour.
- Full load: According to manufacturer's recommendation
- Part load: $\frac{3}{4}$ of the normal amount
- Minimum load: $\frac{1}{2}$ of full load

Adding Detergent

- Detergent for main wash ① only → 
- Detergent for pre wash ② and main wash ① →  ● 

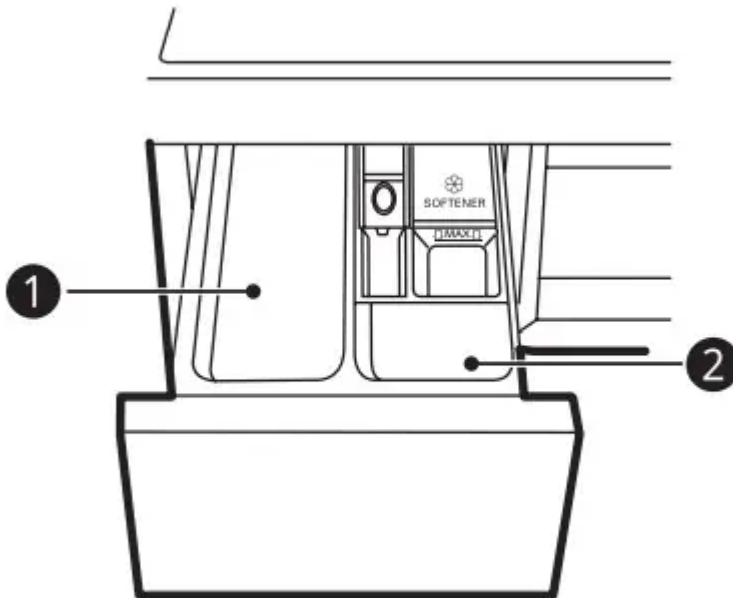

NOTE

- Use the appropriate amount of detergent. Too much detergent, bleach or softener may cause an overflow.
- When selecting Pre Wash, divide the dosage into $\frac{1}{3}$ for pre wash and $\frac{2}{3}$ for main wash.

Adding Detergent Tablet

Detergent tablet is also available when washing laundry.

1. Open the door and put detergent tablets into the drum.

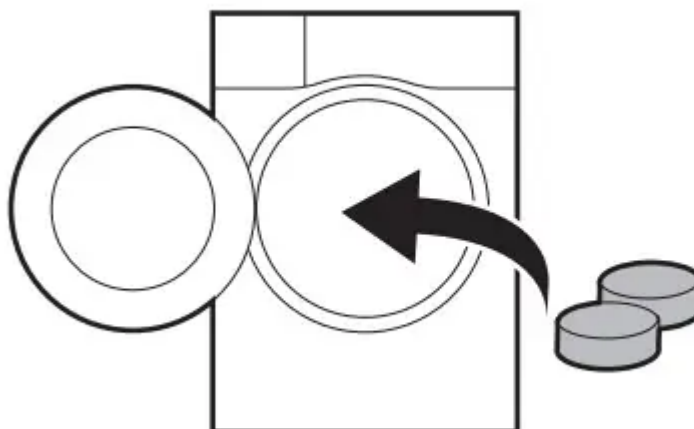

2. Load the laundry into the drum and close the door.

NOTE • Do not put tablets into the drawer.

Adding Fabric Softener

- Add a fabric softener to the maximum fill line.

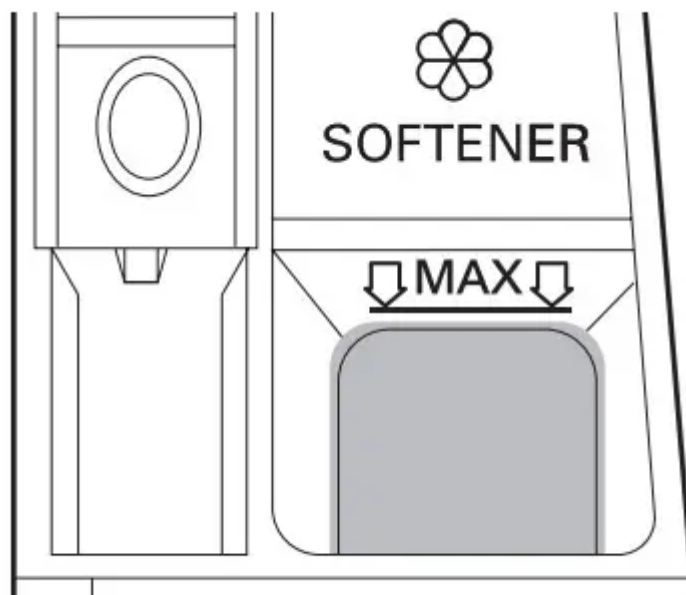

- Close the dispenser drawer gently.
- Do not leave the fabric softener in the detergent drawer for more than 2 days. Fabric softener may harden.

- Softener will automatically be added during the last rinse cycle.
- Do not open the drawer when water is being supplied.
- Solvents (e.g. benzene, etc.) must not be used.

NOTE

- Pouring excessive fabric softener over the maximum fill line can cause it to dispense too early, which may stain clothes.
- Do not pour fabric softener directly onto the laundry, which may stain the laundry.

Adding Water Softener

A water softener, such as anti-limescale can be used to cut down on the use of detergent in areas with high water hardness level.

- First add detergent, and then the water softener. Dispense according to the amount specified on the packaging.

Control Panel

Control Panel Features

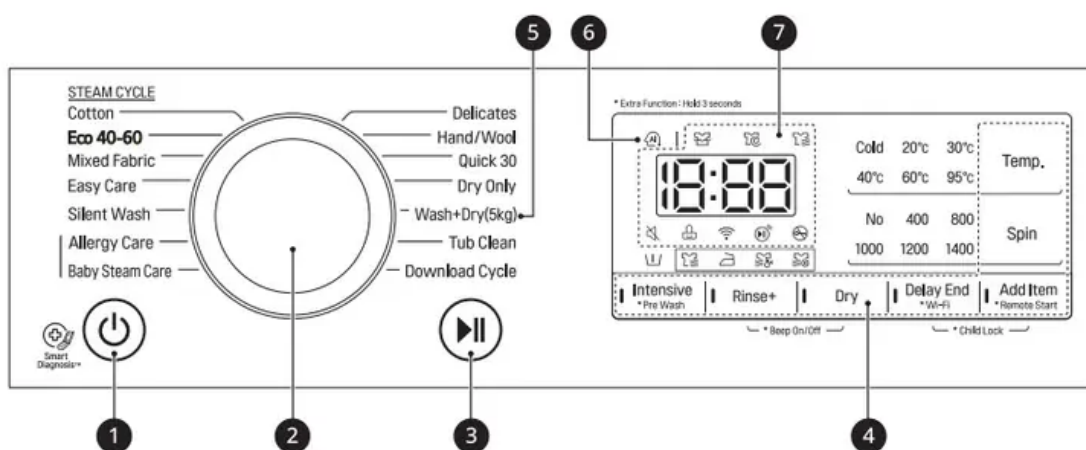

1. Power Button

- Press the Power button to turn on or off the appliance.

2. Programme Knob

- Programmes are available according to the laundry type.
- The lamp will light up to indicate the selected programme.

3. Start/Pause Button

- Press the Start/Pause button to start or pause a wash cycle.
- Press the Start/Pause button to stop a wash cycle temporarily.



4. Extra Options and Functions

- You can use the extra options and functions to customize the programmes.
 - To use the extra functions, press and hold the corresponding button for 3 seconds. The corresponding symbol lights up in the display.
 - In order to use the Remote Start function, refer to SMART FUNCTIONS.
 - This allows you to select an additional programmes and will light when selected.
-  : This icon turns on when the appliance is connected to Wi-Fi network at home.





5. Wash+Dry ()

- () indicates the drying capacity, which varies on the models.

6. AI DD

- AI DD  provides the desired washing and spinning.
-  is activated when Cotton, Mixed Fabric and Easy Care programmes are selected and operated.

7. Display

- The display shows the settings, remaining estimated time, options, and status messages. When the appliance is turned on, the default settings in the display will light up.
- 18:88: When a programme is selected, the default time for that programme is displayed. The default time can be changed according to the selected option.
 -  : When the laundry is being washed, this icon is illuminated.
 -  : When the laundry is being rinsed after completion of washing programme, this icon is illuminated.
 -  : When the laundry is spun to remove the water in the laundry, this icon is illuminated.
 -  : When this icon is illuminated, the door cannot be opened.

Programme Table

Washing Programme

Programme	Cotton	Max. Load	Rating
Description	Washes the laundry by combining various drum motions. Use for coloured fast items (shirts, nightdresses, pajamas, etc.) and normally soiled cotton load (underwear).		
Proper Temperature	40 °C (Cold to 95 °C)		
Max. Spin Speed	1400 rpm		

Programme	Eco 40 - 60	Max. Load	Rating
Description	Washes the large amount of laundry with less energy consumption than other washing programmes. Use for coloured fast items (shirts, nightdresses, pajamas, etc.) and normally soiled cotton items (underwear).		
Proper Temperature	60 °C (Cold to 60 °C)		
Max. Spin Speed	1400 rpm		

Programme	Mixed Fabric	Max. Load	3.0 kg
Description	Enables various fabrics to be washed simultaneously. Use for various kind of fabrics except special items (silk/delicate, sports wear, dark clothes, wool, duvet/curtains).		
Proper Temperature	40 °C (Cold to 60 °C)		
Max. Spin Speed	1400 rpm		

Programme	Easy Care	Max. Load	3.0 kg
Description	Washes laundry that do not need ironing after washing. Use for Polyamide, acrylic, polyester.		
Proper Temperature	40 °C (cold to 60 °C)		
Max. Spin Speed	1400 rpm		

Programme	Silent Wash	Max. Load	4.5 kg
Description	Washes laundry with less noise and vibration than other washing programmes. Use for coloured fast garments (shirts, nightdresses, pajamas, etc.) and lightly soiled white cotton (underwear).		
Proper Temperature	40 °C (Cold to 60 °C)		
Max. Spin Speed	1000 rpm		

Programme	Allergy Care	Max. Load	3.0 kg
Description	Reduces house dust mite allergens. Use for cotton, underwear, pillow covers, bed sheets, baby wear.		
Proper Temperature	60 °C		
Max. Spin Speed	1400 rpm		

Programme	Baby Steam Care	Max. Load	4.5 kg
Description	Washes clothes with gentle motions using steam.		
Proper Temperature	60 °C		
Max. Spin Speed	1000 rpm		

Programme	Delicates	Max. Load	2.0 kg
Description	Washes machine-washable lingerie, sheer and lacy clothes. Use for cotton, underwear, pillow covers, bed sheets, baby wear.		
Proper Temperature	20 °C (Cold to 40 °C)		
Max. Spin Speed	800 rpm		

Programme	Hand/Wool	Max. Load	1.5 kg
Description	Washes hand- and machine-washable delicate clothes such as washable wool, lingerie, dresses etc. (Use detergent for machine washable woolens.) Use for cotton, underwear, pillow covers, bed sheets, baby wear.		
Proper Temperature	30 °C (Cold to 40 °C)		
Max. Spin Speed	800 rpm		

Programme	Quick 30	Max. Load	2.0 kg
Description	Provides fast washing time for small loads and lightly soiled clothes.		
Proper Temperature	20 °C (Cold to 40 °C)		
Max. Spin Speed	1400 rpm		

Programme	Dry Only	Max. Load	Rating (Dry)
Description	Uses the automatic programmes to dry most loads. For most drying, make sure all laundry are similar in material and thickness.		
Proper Temperature	-		
Max. Spin Speed	1400 rpm		

NOTE

- Select the proper wash temperature and spin speed for the desired programmes.
- When washing, always pay attention to the care label of your clothes.
- Actual maximum spin speed may vary depending on the model, programme, and load conditions.

Drying Programme

Programme	Normal 
Description	Reduces the drying time and energy usage during dry cycle for cottons. Use for cotton or linen fabrics such as cotton towels, T-shirts.
Max. Load	Rating

Programme	Iron 
Description	Suitable for ironing to dry clothes easily in damp condition. Use for cotton or linen fabrics which is ready to get ironing at the end of programme.
Max. Load	Rating

Programme	Low Temp. 
Description	Suitable for drying in low temperature for less clothes damage. Use for easy care textiles, synthetic fabrics.
Max. Load	3.5 kg

Programme	Normal Eco 
Description	Suitable for energy dry programme. Use for cotton or linen fabrics such as cotton towels, T-shirts.
Max. Load	Rating

Programme	Time Dry 30 min.	Time Dry 60 min.	Time Dry 120 min.
Description	You can change the drying time according to the maximum load.		
Max. Load	1 kg	2 kg	4 kg

Set programme at 'Wash : Eco 40 - 60 , 60 °C, and 'Dry : Nomal Eco Dry (())' for test in accordance with EN50229.

NOTE

- Select maximum selectable spin speed of washing programme to ensure drying results.
- Where the amount of laundry to be washed and dried in one programme does not exceed the maximum weight permitted for the drying programme, washing and drying in one continuous sequence is recommended.

NOTE

- The test results depend on water pressure, water hardness, water inlet temperature, room temperature, type and amount of laundry, type and amount of detergent and fluctuations in the main electricity supply and chosen additional options.
- Neutral detergent is recommended.
- The actual washing temperature may differ from the temperature of washing programmes stated in the table.

Extra Options

Programme	Pre Wash	Delay End	Add Item	Rinse+	Intensive	Dry
Cotton	●	●	●	●	●	●
Eco 40 - 60	●	●	●	●		●
Mixed Fabric	●	●	●	●	●	●
Easy Care	●	●	●	●	●	●
Silent Wash		●	●	●	●	●
Allergy Care		●	●	●	●	●
Baby Steam Care		●	●	●	●	●
Delicates		●	●	●	●	
Hand/Wool		●	●	●	●	
Quick 30	●	●	●	●	●	●
Dry Only		●	●			●
Wash+Dry(5kg)	●	●	●	●	●	●
Tub Clean						
Download Cycle		●	●	●		●

* This option is automatically inserted in the programme and cannot be deselected.

SMART FUNCTIONS

LG ThinQ Application

The LG ThinQ application allows you to communicate with the appliance using a smartphone.

LG ThinQ Application Features

Communicate with the appliance from a smartphone using the convenient smart features.

Washer Cycle (Remote Start, Download Cycle)

Set or download any preferred cycle and operate by remote control.

Tub Clean Coach

This function shows how many cycles remain before running the Tub Clean function.

Energy Monitoring

This function checks the energy consumption of the recently used cycles and monthly average.

Smart Diagnosis

This function provides useful information for diagnosing and solving issues with the appliance based on the pattern of use.

Settings

Allows you to set various options on the appliance and in the application.

Push Alert

When the cycle is complete or the appliance has problems, you have the option of receiving push notifications on a smartphone. The notifications are triggered even if the LG ThinQ application is off.

NOTE

- If you change your wireless router, Internet service provider, or password, delete the registered appliance from the LG ThinQ application and register it again.
- The application is subject to change for appliance improvement purposes without notice to users.
- Functions may vary by model.

Before Using LG ThinQ Application

1. Check the distance between the appliance and the wireless router (Wi-Fi network).
 - If the distance between the appliance and the wireless router is too far, the signal strength becomes weak. It may take a long time to register or installation may fail.
2. Turn off the Mobile data or Cellular Data on your smartphone.
 -

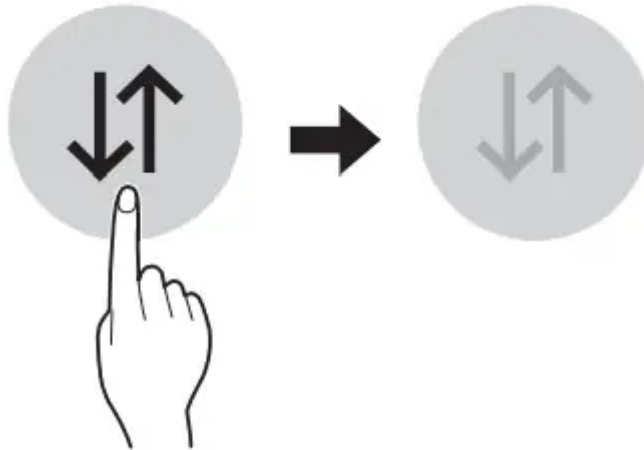

3. Connect your smartphone to the wireless router.

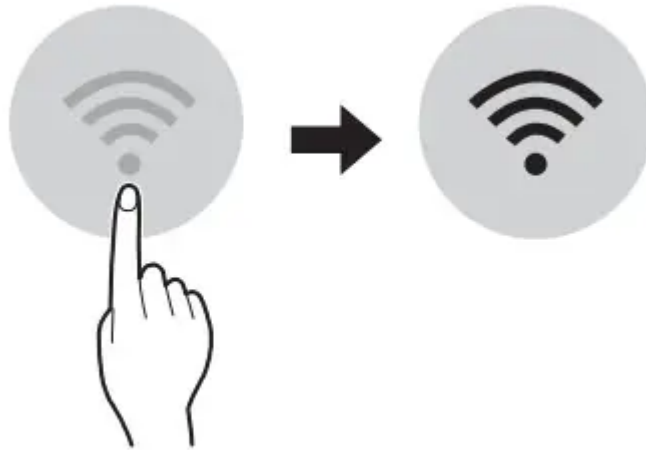

NOTE

- To verify the Wi-Fi connection, check that the Wi-Fi icon on the control panel is lit.
- The appliance supports 2.4 GHz Wi-Fi networks only. To check your network frequency, contact your Internet service provider or refer to your wireless router manual.
- LG ThinQ is not responsible for any network connection problems or any faults, malfunctions, or errors caused by network connection.

NOTE

- If the appliance is having trouble connecting to the Wi-Fi network, it may be too far from the router. Purchase a Wi-Fi repeater (range extender) to improve the Wi-Fi signal strength.
- The Wi-Fi connection may not connect or may be interrupted because of the home network environment.
- The network connection may not work properly depending on the Internet service provider.
- The surrounding wireless environment can make the wireless network service run slowly.
- The appliance cannot be registered due to problems with the wireless signal transmission. Unplug the appliance and wait about a minute before trying again.
- If the firewall on your wireless router is enabled, disable the firewall or add an exception to it.
- The wireless network name (SSID) should be a combination of English letters and numbers. (Do not use special characters.)
- Smartphone user interface (UI) may vary depending on the mobile operating system (OS) and the manufacturer.

- If the security protocol of the router is set to WEP, you may fail to set up the network. Please change it to other security protocols (WPA2 is recommended) and register the product again.

Installing the LG ThinQ Application

Search for the LG ThinQ application from the Google Play Store or Apple App Store on a smartphone. Follow instructions to download and install the application.

Using the Appliance Remotely

Remote Start

Use a smartphone to control your appliance remotely. You can also monitor your cycle operation so you know how much time is left in the cycle.

Using this function

1. Put the laundry into the drum and add detergent into the detergent dispenser drawer.
 - If desired, add bleach or fabric softener to the appropriate areas of the dispenser.
2. Press the Power button.
3. Press and hold Remote Start button for 3 seconds to enable the remote control function.
4. Start a cycle from the LG ThinQ application on your smartphone.

NOTE

- Once this function is enabled, you can only start a cycle from the LG ThinQ smartphone application. If the cycle is not started, the appliance will wait to start the cycle until it is turned off remotely from the application or this function is disabled.
- If the door has been opened, you can not start a cycle remotely

Disable this function manually

When this function is activated, press and hold the Remote Start button for 3 seconds.

Download Cycle



You can download new and special cycles that are not included in the basic cycles on the appliance. Appliances that have been successfully registered can download a variety of specialty cycles specific to the appliance.

Once cycle download is completed in the appliance, the product keeps the downloaded cycle until a new cycle is downloaded.

NOTE • Only one downloaded cycle can be stored on the appliance at a time.

Using Audible Diagnosis to Diagnose Issues

Follow the instructions below to use the audible diagnosis method.

- Launch the LG ThinQ application and select the Smart Diagnosis feature in the menu. Follow the instructions for audible diagnosis provided in the LG ThinQ application.
1. Press the Power button to turn on the appliance.
 - Do not press any other buttons.
 2. Place the mouthpiece of your smartphone close to the  or  logo.

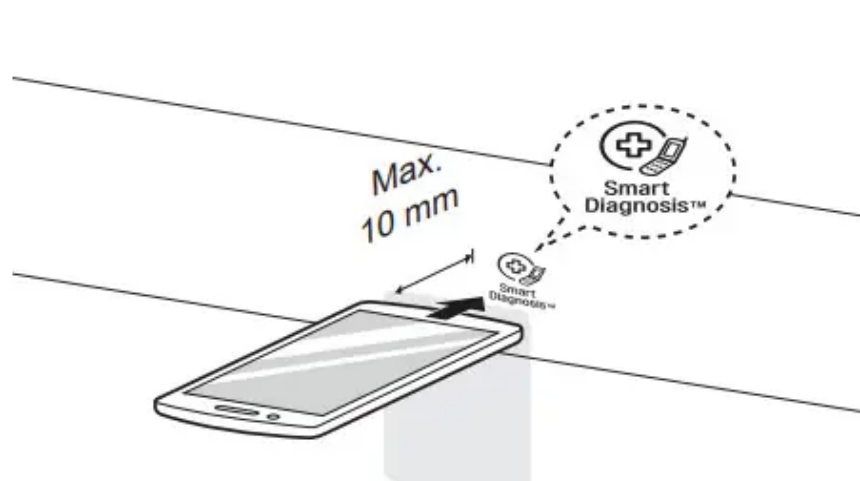

3. Press and hold the Temp. button for 3 seconds or longer while holding the smartphone mouthpiece to the logo until the data transfer is complete.
 - Keep the smartphone in place until the data transfer has finished. Time remaining for data transfer is displayed.
4. After the data transfer is complete, the diagnosis will be displayed in the application.

NOTE • For best results, do not move the smartphone while the tones are being transmitted

MAINTENANCE

WARNING

- Unplug the appliance before cleaning to avoid the risk of electric shock. Failure to follow this warning may result in serious injury, fire, electric shock, or death.
- Never use harsh chemicals, abrasive cleaners, or solvents to clean the appliance. They may damage the finish.

Cleaning After Every Wash

Care After Wash

- After the wash cycle is finished, wipe the door and door seal to remove any moisture.
- Leave the door slightly open to dry the drum.
- Wipe the appliance with a dry cloth to remove any moisture.

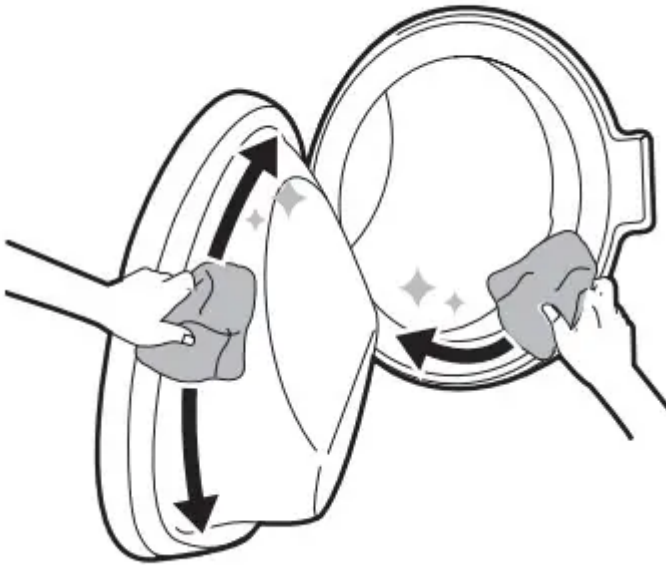

WARNING • Leave the door open to dry the drum interior but only if it is safe and any children are supervised.

Cleaning the Exterior

Proper care of the appliance can extend the service life.

Exterior

- Immediately wipe off any spills. Wipe with a damp cloth.
- Wipe with a damp cloth and then again with a dry cloth ensuring there is no moisture in cabinet joints or crevices.
- Do not press on the surface on the display with sharp objects.

Door

Wash with a damp cloth on the outside and inside and then dry with a soft cloth.

WARNING Do not attempt to separate any panels or disassemble the appliance. Do not apply any sharp objects to the control panel in order to operate the appliance.

Cleaning the Interior

- Use a towel or soft cloth to wipe around the door opening and door glass.

- Always remove items from the appliance as soon as the cycle is complete. Leaving damp items in the appliance can cause wrinkling, colour transfer, and odour.

Cleaning the Appliance Periodically

Tub Clean

Use this function to clean inside of the appliance.

A higher water level is used in this programme at higher spin speed. Run this function once a month (or more often if needed) to remove detergent buildup and other residue.

1. Remove any clothing or items from the appliance and close the door.
2. Open the dispenser drawer and add anti-limescale powder to the main wash compartment.

- Put tablets into the drum.

3. Close the dispenser drawer slowly
4. Turn on the power, and then select the Tub Clean.

-  will be displayed on the display.

5. Press the Start/Pause button to start.
6. After the programme is complete, leave the door open to dry the door opening, gasket, and door glass.

WARNING • Leave the door open to dry inside of the appliance only if the children are supervised at home.

Cleaning the Water Inlet Filter

Water inlet filter collects lime or any small objects that may be in water supplied to the appliance. Clean the water inlet filter regularly

NOTE

- Turn off the supply tap to the appliance if the appliance is to be left for a certain period of time (e.g. holiday), especially if there is no floor drain (gully) in the immediate vicinity.
-  error message will be displayed on the control panel when water is not entering the detergent drawer.

- If the water is very hard or contains traces of limescale, the filter on the water inlet may be clogged.

1. Turn off the water tap and unscrew the water inlet hose.

◦

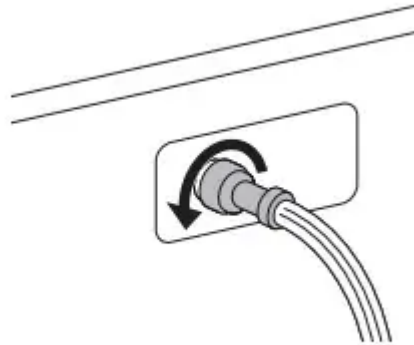

2. Clean the filter using a medium bristle tooth brush.

◦

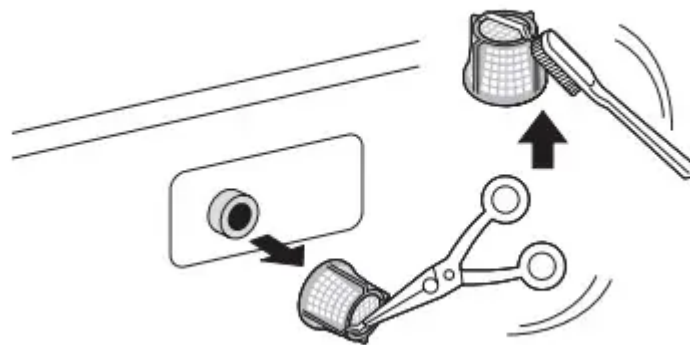

Cleaning the Drain Pump Filter

The drain filter collects threads and small objects left in the laundry. Check regularly that the filter is clean to ensure smooth running of your appliance. Allow the water to cool before cleaning the drain pump filter. Open the door in an emergency or perform a emergency evacuation.

1. Unplug the appliance.

2. Open the cover cap and pull out the hose.

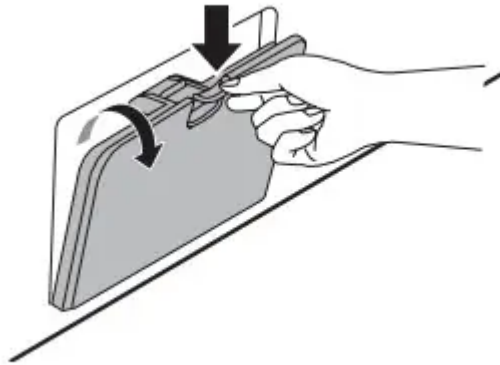

3. Unscrew the drain plug **1**, and then drain the water. Slowly unscrew the drain pump filter **2** to drain the water and remove small objects.

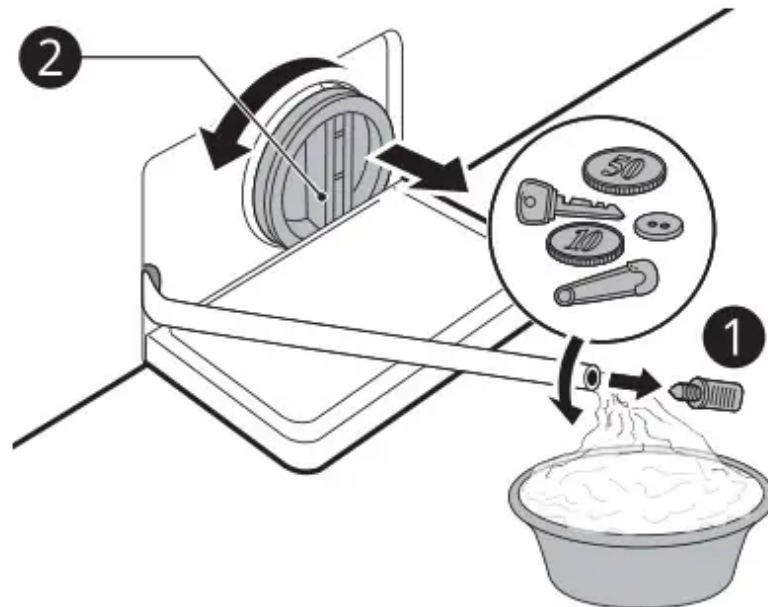

4. After cleaning the drain pump filter, take the drain pump filter out and insert the drain plug.

5. Close the cover cap.

CAUTION

- Be careful when draining, as the water may be hot.
- Run the drum cleaning programme once a month (or more often, as needed) to remove excess detergent and other debris.

Cleaning the Dispenser Drawer

Detergent and fabric softener may build up in the dispenser drawer. Remove the drawer and the components of the drawer in the drawer and check for build-up of detergents or softeners once or twice a month.

1. Remove the detergent dispenser drawer by pulling the drawer straight out until the drawer stops.
 - Remove the drawer while pressing the release button on the inside of the detergent drawer.
 -

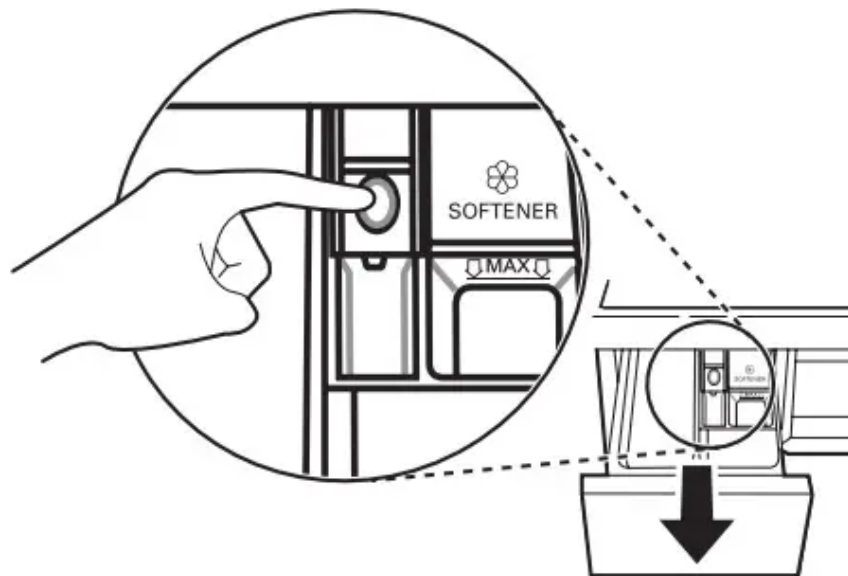

2. Remove the build-up of detergent and softener.
 - Rinse the drawer and the components of the drawer with warm water to remove the buildup from detergent and softener. Use only water to clean the dispenser drawer. Dry the drawer and the components of the drawer with a soft cloth or towel.
3. To clean the drawer opening, use a cloth or small, non-metal brush to clean the recess.
 - Remove all residue from the upper and lower parts of the recess.
4. Wipe any moisture off the detergent drawer recess with a soft cloth or towel.
5. Re-assemble the components of the drawer to the proper compartments and insert the drawer

TROUBLESHOOTING

Error Messages

The appliance is equipped with an automatic error-monitoring system to detect and diagnose problems at an early stage. If this appliance does not function properly or does not function at all, check the following before you call LG Electronics service centre.

1. **IE** INLET ERROR

- Water supply is not adequate in that location. Water does not enter appliance or it enters slowly.
 - Check another tap in the house.
- Water supply tap is not completely open. Water does not enter the appliance or it enters slowly.
 - Open fully tap.
- Water supply hose(s) are kinked.
 - Straighten hose or reinstall the water inlet hose
- The filter of the supply hose(s) are clogged.
 - Check and clean the filter of the inlet hose.

2. **OE** WATER OUTLET ERROR

- Drain hose is kinked or clogged. Water in the appliance does not drain or drains slowly.
 - Clean and straighten the drain hose.
- The drain filter is clogged.
 - Check and clean the drain filter.

3. **UE** UNBALANCE ERROR

- The appliance has a system which detects and corrects the unbalance of the appliance.
 - The laundry may be too wet at the end of the cycle, rearrange the laundry to allow proper spinning. Close the door and press Start/ Pause button. It may take a few moments before the appliance begins to spin. The door must be locked before spin can be achieved.

- Load is too small. This system may stop spinning or even interrupt the spin cycle altogether if individual heavy items (e.g. bath mat, bath robe, etc.) are loaded.
 - Add 1 or 2 similar items or items to help balance the laundry. Close the door and press Start/Pause button. It may take a few moments before the appliance begins to spin. The door must be locked before spin can be achieved.

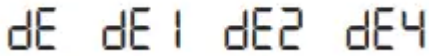
4.  DOOR ERROR

- Door sensor malfunctions.
 - Please call LG Electronics service centre. You can find your local LG Electronics service centre phone number in the warranty card.

5.  CONTROL ERROR

- This is a control error.
 - Unplug the power plug and call for service.

6.  MOTOR LOCKED ERROR

- Over load in motor
 - Let the appliance wait for 30 minutes until the motor is cooled down and then, restart the cycle

7.  PRESSURE SENSOR ERROR

- Water level sensor malfunctions.
 - Close the water tap.
 - Unplug the power plug.
 - Call for service.

8.  VIBRATION SENSOR ERROR

- Vibration sensor malfunctions.
 - Call for service.

9. | **FS** FROZEN FAILURE

- Is supply/drain hose or drain pump frozen?
 - Supply warm water into the drum in order to unfreeze the drain hose and the drain pump. Cover the supply hose with wet and warm towel.

10. **AE** WATER LEAKAGE

- Water leaks.
 - Call for service.

11. **PF** POWER FAILURE

- The appliance experienced a power failure.
 - Restart the cycle.

12. **dHE** DRY ERROR

- Does not dry.
 - Call for service.

Noises You Might Hear

1. Rattling and clanking noise

- Foreign objects, such as keys, coins, or safety pins may be in the drum.
 - Stop the appliance, check the drum for foreign objects. If the noise continues after the appliance is restarted, call for service.

2. Thumping sound

- Heavy laundry may produce a thumping sound. This is usually normal.
 - If the sound continues, the appliance is probably out of balance. Stop and redistribute the laundry.
- The laundry may be out of balance.
 - Pause the cycle and redistribute the laundry after the door unlocks.

3. Vibrating noise

- Package materials are not removed.
 - Remove package materials.

- The laundry may be unevenly distributed in the drum.
 - Pause the cycle and redistribute the laundry after the door unlocks.
- Not all leveling feet are resting firmly and evenly on the floor.
 - See the Leveling the Appliance to adjust the leveling of the appliance.
- Floor not rigid enough.
 - Check if the floor is solid and does not flex. See the Installation Place Requirements to select the proper location.

Operation

1. Water is leaking.

- House drain pipes are clogged.
 - Unclog the drain pipe. Contact plumber if necessary.
- Leakage is caused by improper installation of drain hose or clogged drain hose.
 - Clean and straighten the drain hose. Check and clean the drain filter regularly.

2. Appliance does not operate.

- Control panel has powered off due to inactivity.
 - This is normal. Press the Power button to turn the appliance on.
- Appliance is unplugged.
 - Make sure that the cord should be plugged securely into a working outlet.
- Water supply is turned off.
 - Turn the water supply tap completely

3. Appliance does not operate.



- Controls are not set properly.
 - Make sure that the cycle should be correctly set. Close the door and press the Start/Pause button.
- Door is open.
 - Close the door and make sure that nothing should be caught under the door preventing it from closing completely.

- Circuit breaker/fuse is tripped/blown.
 - Check house circuit breakers/fuses. Replace fuses or reset breaker. The appliance should be on a dedicated branch circuit. The appliance will resume the cycle where it stopped once power is restored.
- Control needs to be reset.
 - Press the Power button, then reselect the desired programme and press the Start/Pause button.
- Start/Pause was not pressed after a cycle was set.
 - Press the Power button, then reselect the desired programme and press the Start/Pause button. The appliance is turned off if the Start/Pause button is not pressed within 15 minutes.
- Extremely low water pressure.
 - Check another tap in the house to make sure that household water pressure should be adequate.
- Appliance is heating the water or making steam.
 - The drum may stop operating temporarily during certain cycles, while water is safely heated to a set temperature.

4. Buttons may not function properly

- The door cannot be opened for safety reasons once the appliance starts.
 - Check if the  is illuminated. You can safely open the door after the Door Lock icon turns off.

5. Door does not open.

- The door cannot be opened for safety reasons once the appliance starts.
 - Check if the  icon is illuminated. You can safely open the door after the  icon turns off.

6. Appliance is not filling properly

- Filter clogged.
 - Make sure the inlet filters on the fill valves are not clogged.
- Inlet hoses may be kinked.
 - Check that inlet hoses are not kinked or clogged.

- Insufficient water supply.
 - Make sure that both hot and cold water taps should be turned on all the way.
- Hot and cold inlet hoses are reversed.
 - Check inlet hose connections.

7. Appliance does not drain water.

- Kinked drain hose.
 - Ensure that the drain hose is not kinked.
- Drain located higher than 1.2 m above the floor.
 - Make sure that the drain hose should not be higher than 1.2 m above the bottom of the appliance.

8. Detergent is not dispensed incompletely or not dispensed at all.

- Too much detergent is used.
 - Follow the guidelines provided by the detergent manufacturer.

9. Cycle time is longer than usual.

- The load is too small.
 - Add more items to allow the appliance to balance the laundry.
- Heavy items are mixed with lighter items.
 - Always try to wash items with similar weight in order to allow the appliance to evenly distribute the weight of the laundry for spinning.
- The load is out of balance.
 - Manually redistribute the laundry if items have become tangled.

10. Duration is delayed

- Unbalance is detected or suds removing programme is on.
 - This is normal. The time remaining shown on the display is only an estimated duration. Actual time may vary

Performance

1. Poor stain removal

- Previously set stains.
 - Items that have been previously washed may have stains which have been set. These stains may be difficult to remove and may require hand washing or pre-treating to aid in stain removal.

2. Staining

- Bleach or softener is dispensed too soon.
 - Dispenser compartment is overfilled. It makes bleach or softer dispensed rapidly. Always measure bleach or softener to prevent overfilling.
 - Close the dispenser drawer gently.
- Bleach or softener was added directly to the laundry in the drum.
 - Always use the dispensers to ensure that laundry products are properly dispensed at the right time in the cycle.
- Clothes were not properly sorted.
 - Always wash dark colours separately from light colours and whites to prevent discolouration.
 - Never wash heavily soiled items with lightly soiled items.

3. Wrinkling

- Appliance is not unloaded promptly.
 - Always remove items from the appliance as soon as the cycle is complete.
- Appliance is overloaded.
 - The appliance can be fully loaded, but the drum should not be tightly packed with items. The door of the appliance should be closed easily.
- Hot and cold water inlet hoses are reversed.
 - Hot water rinse can set wrinkles in garments. Check the inlet hose connections.

4. Musty or mildewy odour in appliance

- Inside of drum is not cleaned properly.
 - Run the Tub Clean function regularly.
- The drain hose is not properly installed, causing siphoning (water flowing back inside of the appliance).
 - When installing the drain hose, make sure that it does not get kinked or blocked.
- The detergent dispenser drawer is not cleaned regularly.
 - Clean the detergent dispenser drawer, especially the top and the bottom of the drawer's opening.

- Odours can occur due to the rubber attached to the appliance.
 - It is the normal odour of new rubber and will disappear after operating the appliance several times.
- If the rubber door gasket and door seal area are not cleaned regularly, odors can occur due to mold or foreign substances.
 - Be sure to clean the gasket and door seal regularly and check under the door seal for small items when unloading the appliance.
- Odors can occur due to foreign substances left in the drain pump filter.
 - Be sure to clean the drain pump filter regularly.
- When using the drying function, odours can occur due to lint and other laundry matters sticking to the heater. (Dryer model only)
 - This is not a malfunction.
- A particular odour can occur when drying wet clothes with hot air. (Dryer model only)
 - The odour will immediately disappear.

Drying

1. Not drying

- Depending on the type and thickness of fabric, drying time and performance may be different.
 - Dry again with Time Dry cycle.
- After drying cycle, warm clothes may be wet a little to prevent damage or wrinkle.
 - Hang out the clothes in cool place.
- The appliance is overloaded.
 - Check the load capacity for the selected cycle. If necessary, add Time Dry cycle.
- Drying performance can be decreased for blankets or bulky clothes due to little movement space while drying.
 - Rearrange clothes and use Time Dry cycle.
- Clothes are stuck in the drum after spinning.
 - Rearrange clothes and use Time Dry cycle. The spin speed is too low or spin cycle is not used.
 - Select the highest spin speed allowed for the washing cycle.

- Water pressure is weak or water is not supplied.
 - Check if the water supply tap is closed or not.
 - Check if the drain hose is kinked or not.
 - Check if the inlet valve filter is blocked or not.
- Water does not drain properly.
 - Check if the drain pump filter is clogged or not.
 - Check if the drain hose is kinked or not.

2. Long drying time

- The actual drying time may vary according to the drying time estimated by the sensor of drying cycle. Drying time may vary depending on the type of fabric, load, and selected dry level.
 - This is normal.

Wi-Fi

1. Your home appliance and smart phone are not connected to the Wi-Fi network.

- The password for the Wi-Fi that you are trying to connect to is incorrect.
 - Find the Wi-Fi network connected to your smartphone and remove it, then register your appliance on LG ThinQ.
- Mobile data for your smartphone is turned on.
 - Turn off the Mobile data of your smartphone and register the appliance using the Wi-Fi network.
- The wireless network name (SSID) is set incorrectly.
 - The wireless network name (SSID) should be a combination of English letters and numbers. (Do not use special characters).
- The router frequency is not 2.4 GHz.
 - Only a 2.4 GHz router frequency is supported. Set the wireless router to 2.4 GHz and connect the appliance to the wireless router. To check the router frequency, check with your internet service provider or the router manufacturer.
- The distance between the appliance and the router is too far.
 - If the distance between the appliance and the router is too far, the signal may be weak and the connection may not be configured correctly. Move the location of the router so that it is closer to the appliance.

Warning

This content is compiled from multiple sources and is provided for reference purposes only. It may not be complete or fully applicable to all situations. If you are unable to resolve your issue, please contact the product manufacturer or an authorized service provider for official support.

Document generated by [ManualsFile](#)