

TV Installation

Mounting the TV on a wall

If you mount this TV on a wall, follow the instructions exactly as set out by the manufacturer. If it is not correctly mounted, the TV may slide or fall and cause serious injury to a child or adult and serious damage to the TV

- Refer to the installation manual included with the Samsung wall mount kit.
- You can mount the TV on the wall using a wall mount kit (sold separately).

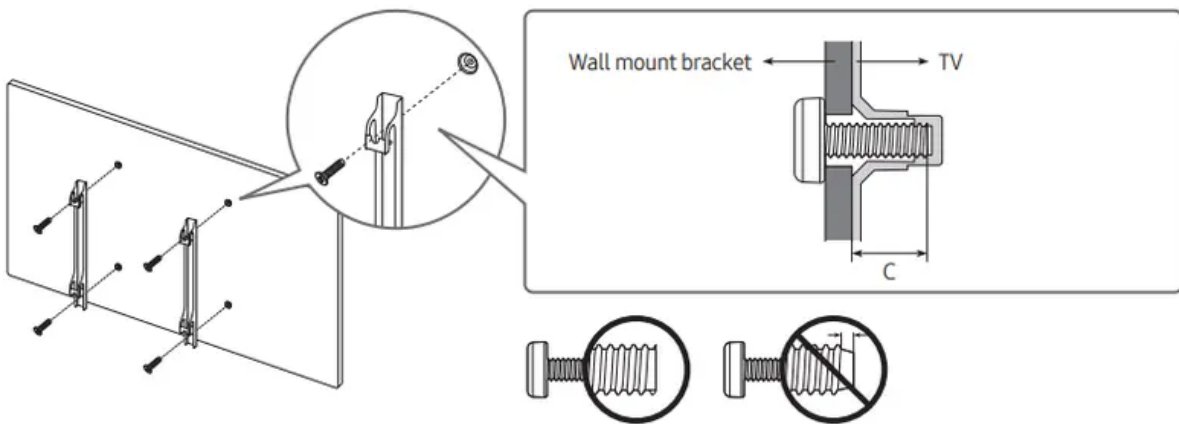

- Samsung Electronics is not responsible for any damage to the product or injury to yourself or others if you choose to install the wall mount on your own.
- To order the wall mount kit, contact Samsung service center at 1-800-SAMSUNG (1-800-726-7864).
- You can install your wall mount on a solid wall perpendicular to the floor. Before attaching the wall mount to surfaces other than plaster board, contact your nearest dealer for additional information. If you install the TV on a ceiling or slanted wall, it may fall and result in severe personal injury.
- When installing a wall mount kit, we recommend you fasten all four VESA screws.
- If you want to install a wall mount kit that attaches to the wall using two top screws only, be sure to use a Samsung wall mount kit that supports this type of installation. (You may not be able to purchase this type of wall mount kit, depending on the geographical region.)
- Standard dimensions for wall mount kits are shown in the table on the next page.
- If you are installing a third-party wall mount, note that the length of the screws you can use to attach the TV to the wall mount is shown in column C in the table on the next page.

Series	Inches	VESA screw hole specs (A * B) in millimeters	C (mm)	Standard Screw	Pitch (mm)	Quantity
Q60T Q6DT Q70T Q7DT	43 50 55	200 x 200	39-41	M8	1.25	4
	58 65	400 x 300				
	75	400 x 400				
	82 85	600 x 400				
	49 55	200 x 200				
65	400 x 300					
75	400 x 400					
Q80T Q8DT	85	600 x 400	25-27			

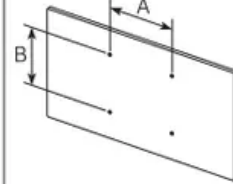

- Do not use screws that are longer than the standard dimension or do not comply with the VESA standard screw specifications. Screws that are too long may cause damage to the inside of the TV set.
- For wall mounts that do not comply with the VESA standard screw specifications, the length of the screws may differ depending on the wall mount specifications.
- Do not fasten the screws too firmly. This may damage the product or cause the product to fall, leading to personal injury. Samsung is not liable for these kinds of accidents.
- Samsung is not liable for product damage or personal injury when a non-VESA or non-specified wall mount is used or when the consumer fails to follow the product installation instructions.
- Do not mount the TV at more than a 15 degree tilt.
- Always have two people mount the TV onto a wall. For 82 inch or larger models, have four people mount the TV onto a wall

Providing proper ventilation for your TV

When you install your TV, maintain a distance of at least 4 inches (10 cm) between the TV and other objects (walls, cabinet sides, etc.) to ensure proper ventilation. Failing to maintain proper ventilation may result in a fire or a problem with the product caused by an increase in its internal temperature.

- When you install your TV with a stand or a wall mount, we strongly recommend you use parts provided by Samsung Electronics only. Using parts provided by another manufacturer may cause difficulties with the product or result in injury caused by the product falling.

Preventing the TV from falling

1. Using the appropriate screws, firmly fasten a set of brackets to the wall. Confirm that the screws are firmly attached to the wall. You may need additional material such as wall anchors depending on the type of wall.
2. Using the appropriately sized screws, firmly fasten a set of brackets to the TV. For the screw specifications, refer to "Standard Screw" in the table.
3. Connect the brackets fixed to the TV and the brackets fixed to the wall with a durable, heavy-duty string, and then tie the string tightly. Install the TV near the wall so that it does not fall backwards. Connect the string so that the brackets fixed to the wall are at the same height as or lower than the brackets fixed to the TV

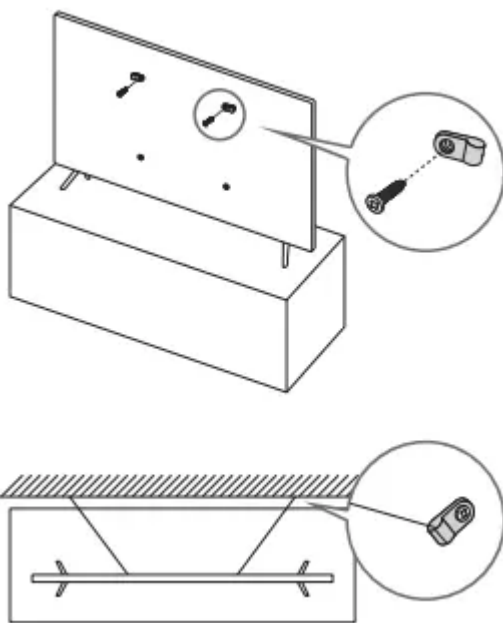

- The product color and shape may vary depending on the model.

The Samsung Smart Remote

About the Buttons on the Samsung Smart Remote

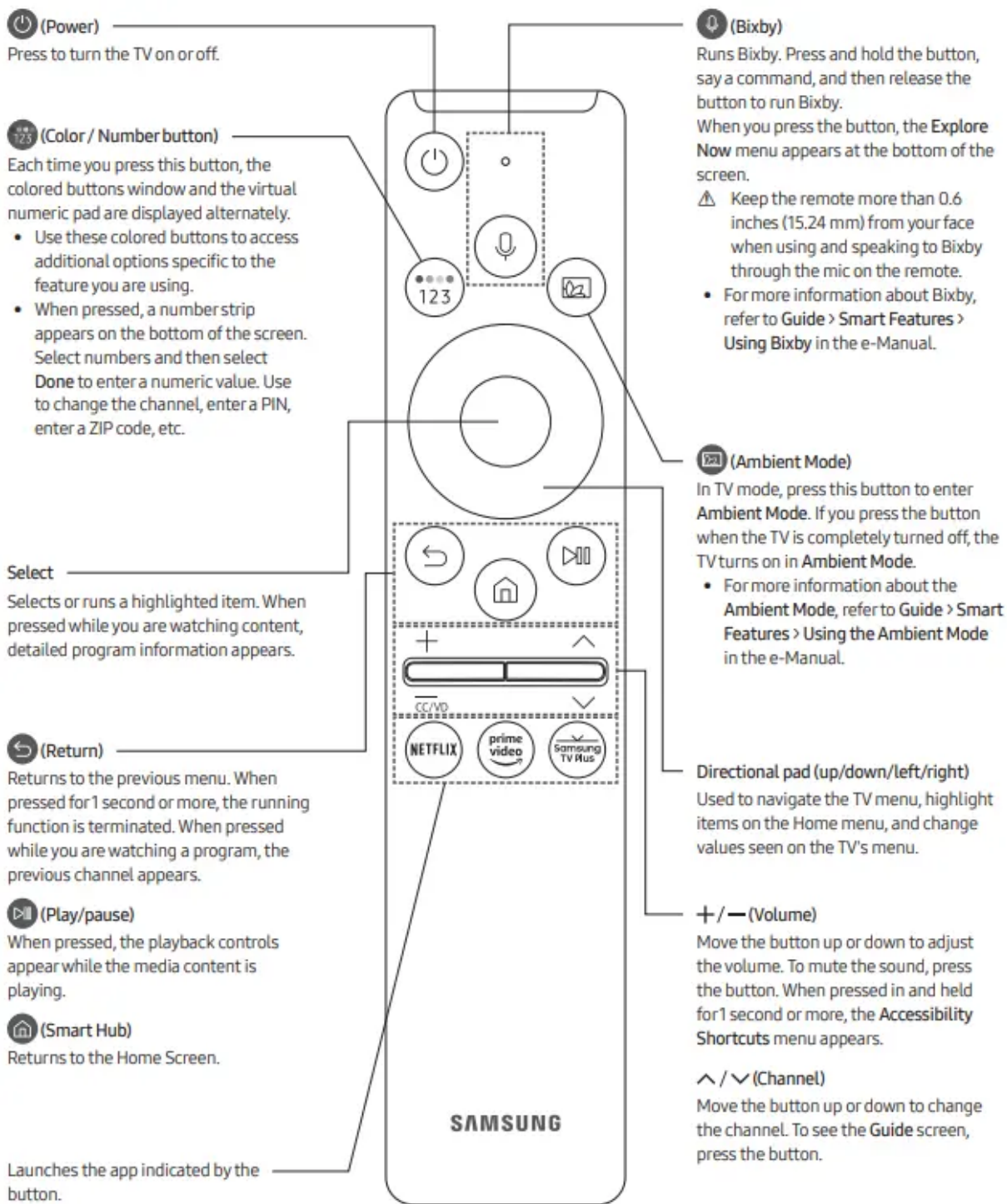

- The images, buttons, and functions of the Samsung Smart Remote may differ depending on the model.
- The Universal Remote function operates normally only when you use the Samsung Smart Remote that comes with the TV.

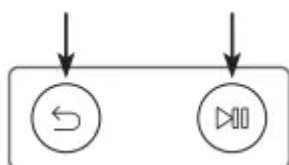

Pairing the TV to the Samsung Smart Remote



When you turn on the TV for the first time, the Samsung Smart Remote pairs to the TV automatically. If the Samsung Smart Remote does not pair to the TV automatically, point it at

the remote control sensor of the TV, and then press and hold the buttons labeled  and  as shown in the figure on the left simultaneously for 3 seconds or more

Installing batteries into the Samsung Smart Remote

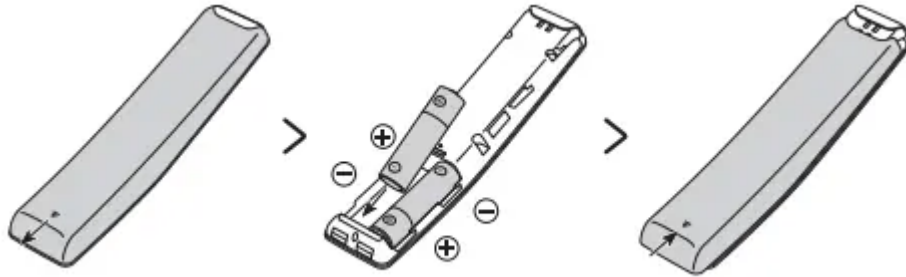

To install the batteries, push the rear cover open in the direction of the arrow at the bottom of the illustration, and then insert the batteries as shown in the figure. Make sure that the positive and negative ends are facing in the correct direction. Close the rear cover as shown.

- Alkaline batteries are recommended for longer battery life.

Initial Setup

When you turn on your TV for the first time, it immediately starts the Initial Setup. Follow the instructions displayed on the screen and configure the TV's basic settings to suit your viewing environment.

- To perform the Initial Setup using the SmartThings app, you must connect your mobile device via Wi-Fi.
- If the pop-up for setup does not appear automatically in the SmartThings app on your mobile device, manually add the TV using Add Device on the dashboard of the SmartThings app, and then continue with the set up process.
- The SmartThings app is available for mobile devices running Android 6.0 or higher or iOS 10 or higher.
- Noise may occur temporarily when the TV communicates with mobile devices

Using the TV Controller

You can turn on the TV with the **TV Controller** button at the bottom of the TV, and then use the **Control menu**. The **Control menu** appears when the **TV Controller** button is pressed while the TV is On. For more information about its usage, refer to the figure below.

- The screen may dim if the protective film on the SAMSUNG logo or the bottom of the TV is not removed. Please remove the protective film.

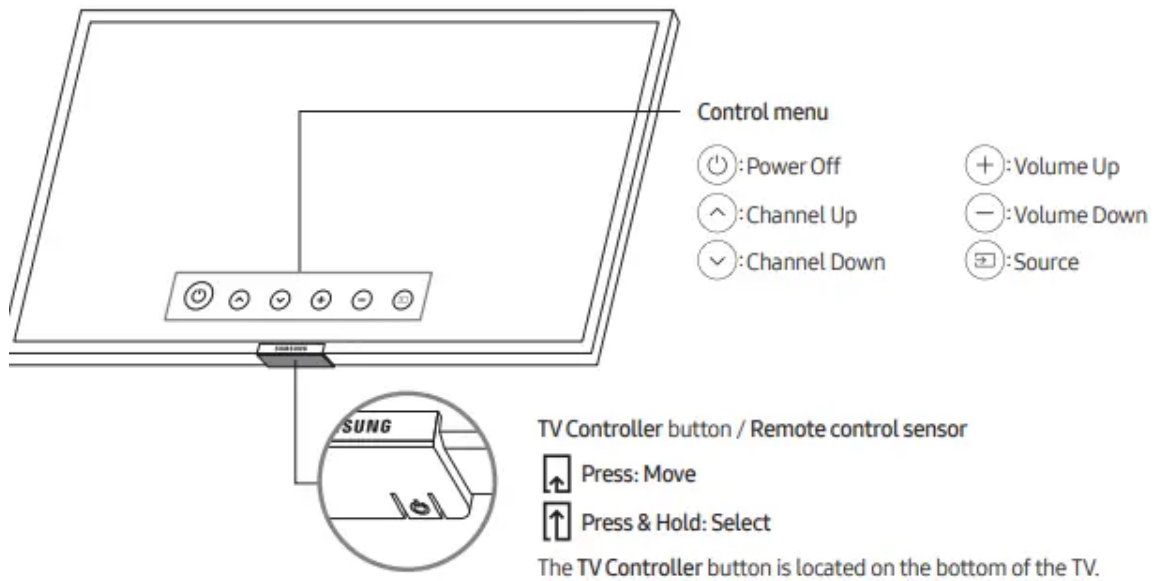

Setting the sound sensor

- This function is supported only in Q70T, Q80T models.



You can turn on or off the sound sensor by using its button at the bottom of the TV.

With the TV on, you can push the button to the left (or backward) to turn on the sound sensor or to the right (or forward) to turn off it.

See the pop-up window on the TV to check whether the sound sensor is turned on or off.



- The position and shape of the sound sensor may differ depending on the model.
- During analysis using data from the sound sensor, the data is not saved.

Troubleshooting and Maintenance

Troubleshooting

If the TV seems to have a problem, first review this list of possible problems and solutions. Alternatively, review the Troubleshooting or FAQ Section in the e-Manual. If none of the







troubleshooting tips apply, please visit "www.samsung.com" and click Support or contact the Samsung service center listed on the back cover of this manual.

- For detailed information on troubleshooting, watch the troubleshooting videos at www.samsung.com/spsn.
- This TFT LED panel is made up of sub pixels which require sophisticated technology to produce. There may be, however, a few bright or dark pixels on the screen. These pixels will have no impact on the performance of the product.
- To keep your TV in optimum condition, upgrade to the latest software. Use the Update Now or Auto Update functions on the TV's menu ( >  Settings > Support > Software Update > Update Now or Auto Update).

The TV won't turn on.

- Make sure that the AC power cord is securely plugged in to the TV and the wall outlet.
- Make sure that the wall outlet is working and the power indicator at the bottom of the TV is lit and glowing a solid red.
- Try pressing the  button at the bottom of the TV to make sure that the problem is not with the remote control. If the TV turns on, refer to "The remote control does not work."

There is no picture/video/sound, or a distorted picture/video/sound from an external device, or "Weak or No Signal" is displayed on the TV, or you cannot find a channel.

- Perform a TV self diagnosis to determine if the problem is caused by the TV or the device ( >  Settings > Support > Device Care > Self Diagnosis > Picture Test or Sound Test).
- If the test results are normal, make sure the connection to the device is correct and that all cables are fully inserted.
- Remove and reconnect all cables connected to the TV and the external devices. Try new cables if possible and confirm that the correct input source has been selected ( >  Source).
- Reboot the connected devices by unplugging each device's power cord and then plugging it in again. If the issue persists, refer to the connection guide in the user manual of the connected device.
- If you are not using a cable box or satellite box, and your TV is receiving TV signals from an antenna or a cable wall connector, run Auto Program to search for channels ( >  Settings > Broadcasting > Auto Program).



The remote control does not work.

- Check if the power indicator at the bottom of the TV blinks when you press the remote's Power button. If it does not, replace the remote control's batteries.
- Make sure that the batteries are installed with their poles (+/-) in the correct direction.
- Try pointing the remote directly at the TV from 5 ft. to 6 ft. (1.5-1.8 m) away.
- If your TV came with a Samsung Smart Remote (Bluetooth Remote), make sure to pair the remote to the TV.



The cable box or satellite box remote control doesn't turn the TV on or off or adjust the volume.

- Program the cable box or satellite box remote control to operate the TV. Refer to the cable box or satellite box user manual for the SAMSUNG TV code.

The TV settings are lost after 5 minutes.

- The TV is in the Retail Mode. Change the Usage Mode in the System Manager Menu to Home Mode ( >  Settings > General > System Manager > Usage Mode > Home Mode).



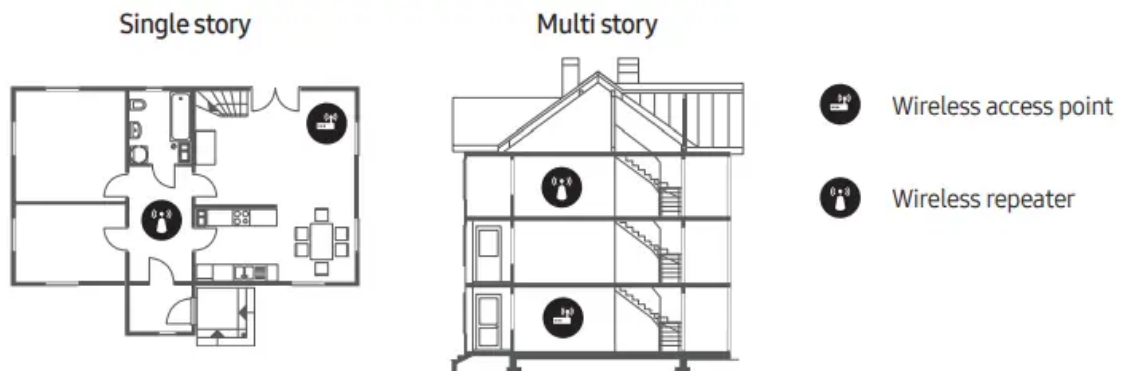

Intermittent Wi-Fi

- Make sure the TV has a network connection ( >  Settings > General > Network > Network Status).
- Make sure the Wi-Fi password is entered correctly.
- Check the distance between the TV and the modem or access point. The distance should not exceed 50 ft (15.2 m).
- Reduce interference by not using or turning off wireless devices. Also, verify that there are no obstacles between the TV and the modem or access point. (The Wi-Fi strength can be decreased by appliances, cordless phones, stone walls/fireplaces, etc.)



- Contact your Internet Service Provider (ISP) and ask them to reset your network circuit to re-register the MAC addresses of your new modem or access point and the TV.

Video Apps problems (Youtube etc)

- Change the DNS to 8.8.8.8. Select  >  Settings > General > Network > Network Status > IP Settings > DNS Setting > Enter manually > DNS Server > enter 8.8.8.8 > OK.
- Reset by selecting  >  Settings > Support > Device Care > Self Diagnosis > Reset Smart Hub.



What is Remote Support?

Samsung Remote Support service offers you one-on-one support with a Samsung Technician who can remotely:

- Diagnose your TV
- Adjust the TV settings for you
- Perform a factory reset on your TV
- Install recommended firmware updates

How does Remote Support work?



You can easily get Samsung Remote Support service for your TV.

1. Call the Samsung service center and ask for remote support.
2. Open the menu on your TV, and then go to the Support menu. ( >  Settings > Support)
3. Select Remote Management, then read and agree to the service agreements. When the PIN screen appears, provide the PIN number to the technician.
4. The technician will then access your TV.

Eco Sensor and screen brightness



Eco Sensor adjusts the brightness of the TV automatically. This feature measures the light in your room and optimizes the brightness of the TV automatically to reduce power

consumption. If you want to turn this off, go to  >  Settings > General > Eco Solution > Ambient Light Detection.

- If the screen is too dark while you are watching TV in a dark environment, it may be due to the Ambient Light Detection function.

- The eco sensor is located at the bottom of the TV. Do not block the sensor with any object. This can decrease picture brightness.

Caring for the TV

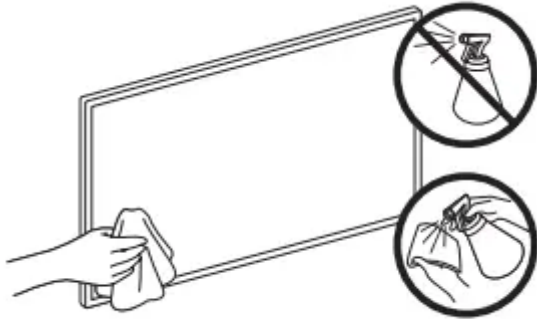

- If a sticker was attached to the TV screen, some debris can remain after you remove the sticker. Please clean the debris off before watching TV.
- The exterior and screen of the TV can get scratched during cleaning. Be sure to wipe the exterior and screen carefully using a soft cloth to prevent scratches.
- Do not spray water or any liquid directly onto the TV. Any liquid that goes into the product may cause a failure, fire, or electric shock.
- To clean the screen, turn off the TV, then gently wipe away smudges and fingerprints on the panel with a micro-fiber cloth. Clean the body or panel of the TV with a micro-fiber cloth dampened with a small amount of water. After that, remove the moisture with a dry cloth. While cleaning, do not apply strong force to the surface of the panel because it can damage the panel. Never use flammable liquids (benzene, thinner, etc.) or a cleaning agent. For stubborn smudges, spray a small amount of screen cleaner on a micro-fiber cloth, and then use the cloth to wipe away the smudges.

Specifications and Other Information

Specifications

Model Name	QN43Q60T / QN43Q6DT	QN50Q60T / QN50Q6DT
Display Resolution	3840 x 2160	3840 x 2160
Screen Size Diagonal Measured Diagonally	43" Class 42.5 inches	50" Class 49.5 inches
Sound (Output)	20 W	20 W
Dimensions (W x H x D) Body With Stand	37.9 x 22.0 x 2.2 inches (963.5 x 557.7 x 56.8 mm) 37.9 x 24.8 x 7.7 inches (963.5 x 629.4 x 195.2 mm)	44.0 x 25.3 x 2.2 inches (1116.4 x 642.9 x 57.1 mm) 44.0 x 28.4 x 9.6 inches (1116.4 x 720.5 x 243.3 mm)
Weight Without Stand With Stand	19.8 lbs (9.0 kg) 20.3 lbs (9.2 kg)	28.4 lbs (12.9 kg) 28.9 lbs (13.1 kg)
Model Name	QN55Q60T / QN55Q6DT / QN55Q70T	QN55Q7DT
Display Resolution	3840 x 2160	3840 x 2160
Screen Size Diagonal Measured Diagonally	55" Class 54.6 inches	55" Class 54.6 inches
Sound (Output)	20 W	20 W
Dimensions (W x H x D) Body With Stand	48.4 x 27.8 x 2.3 inches (1230.1 x 705.9 x 57.4 mm) 48.4 x 30.9 x 9.6 inches (1230.1 x 783.7 x 243.3 mm)	48.4 x 27.8 x 2.3 inches (1230.1 x 705.9 x 57.4 mm) 48.4 x 31.1 x 10.4 inches (1230.1 x 788.8 x 264.1 mm)
Weight Without Stand With Stand	37.9 lbs (17.2 kg) 38.4 lbs (17.4 kg)	37.9 lbs (17.2 kg) 42.3 lbs (19.2 kg)

Model Name	QN58Q60T / QN58Q6DT	QN65Q60T / QN65Q6DT / QN65Q70T
Display Resolution	3840 x 2160	3840 x 2160
Screen Size Diagonal Measured Diagonally	58" Class 57.5 inches	65" Class 64.5 inches
Sound (Output)	20 W	20 W
Dimensions (W x H x D) Body With Stand	50.8 x 29.4 x 2.3 inches (1290.6 x 748.0 x 57.5 mm) 50.8 x 32.5 x 9.6 inches (1290.6 x 826.4 x 243.3 mm)	57.1 x 32.6 x 2.3 inches (1449.6 x 829.3 x 57.6 mm) 57.1 x 35.7 x 11.4 inches (1449.6 x 907.7 x 289.1 mm)
Weight Without Stand With Stand	40.6 lbs (18.4 kg) 41.0 lbs (18.6 kg)	49.2 lbs (22.3 kg) 49.8 lbs (22.6 kg)
Model Name	QN65Q7DT	QN75Q60T / QN75Q6DT / QN75Q70T
Display Resolution	3840 x 2160	3840 x 2160
Screen Size Diagonal Measured Diagonally	65" Class 64.5 inches	75" Class 74.5 inches
Sound (Output)	20 W	20 W
Dimensions (W x H x D) Body With Stand	57.1 x 32.6 x 2.3 inches (1449.6 x 829.3 x 57.6 mm) 57.1 x 35.9 x 12.1 inches (1449.6 x 911.9 x 307.2 mm)	66.0 x 37.8 x 2.4 inches (1675.4 x 959.6 x 60.4 mm) 66.0 x 41.3 x 13.9 inches (1675.4 x 1049.4 x 352.3 mm)
Weight Without Stand With Stand	49.2 lbs (22.3 kg) 54.7 lbs (24.8 kg)	79.4 lbs (36.0 kg) 80.0 lbs (36.3 kg)
Model Name	QN75Q7DT	QN82Q6DT / QN82Q70T / QN82Q7DT
Display Resolution	3840 x 2160	3840 x 2160
Screen Size Diagonal Measured Diagonally	75" Class 74.5 inches	82" Class 81.5 inches
Sound (Output)	20 W	20 W
Dimensions (W x H x D) Body With Stand	66.0 x 37.8 x 2.4 inches (1675.4 x 959.6 x 60.4 mm) 66.0 x 41.0 x 12.7 inches (1675.4 x 1040.6 x 323.0 mm)	72.1 x 41.1 x 2.4 inches (1830.6 x 1044.2 x 60.7 mm) 72.1 x 45.3 x 15.4 inches (1830.6 x 1149.8 x 392.1 mm)
Weight Without Stand With Stand	79.4 lbs (36.0 kg) 87.1 lbs (39.5 kg)	96.3 lbs (43.7 kg) 99.0 lbs (44.9 kg)

Model Name	QN85Q60T / QN85Q6DT / QN85Q70T / QN85Q7DT	QN49Q80T / QN49Q8DT
Display Resolution	3840 x 2160	3840 x 2160
Screen Size Diagonal Measured Diagonally	85" Class 84.5 inches	49" Class 48.5 inches
Sound (Output)	20 W	40 W
Dimensions (W x H x D) Body With Stand	74.7 x 42.6 x 2.4 inches (1896.3 x 1082.5 x 59.9 mm) 74.7 x 46.7 x 15.4 inches (1896.3 x 1186.4 x 392.1 mm)	43.1 x 25.0 x 2.2 inches (1094.8 x 634.4 x 54.9 mm) 43.1 x 28.0 x 9.4 inches (1094.8 x 711.4 x 239.8 mm)
Weight Without Stand With Stand	104.7 lbs (47.5 kg) 107.4 lbs (48.7 kg)	28.9 lbs (13.1 kg) 38.6 lbs (17.5 kg)
Model Name	QN55Q80T / QN55Q8DT	QN65Q80T / QN65Q8DT
Display Resolution	3840 x 2160	3840 x 2160
Screen Size Diagonal Measured Diagonally	55" Class 54.6 inches	65" Class 64.5 inches
Sound (Output)	60 W	60 W
Dimensions (W x H x D) Body With Stand	48.3 x 27.8 x 2.1 inches (1227.6 x 706.7 x 53.9 mm) 48.3 x 30.8 x 10.1 inches (1227.6 x 783.4 x 255.8 mm)	56.9 x 32.7 x 2.1 inches (1446.5 x 829.8 x 53.9 mm) 56.9 x 35.7 x 11.4 inches (1446.5 x 905.7 x 289.1 mm)
Weight Without Stand With Stand	39.5 lbs (179 kg) 46.3 lbs (21.0 kg)	53.1 lbs (24.1 kg) 61.3 lbs (27.8 kg)
Model Name	QN75Q80T / QN75Q8DT	QN85Q80T / QN85Q8DT
Display Resolution	3840 x 2160	3840 x 2160
Screen Size Diagonal Measured Diagonally	75" Class 74.5 inches	85" Class 84.5 inches
Sound (Output)	60 W	60 W
Dimensions (W x H x D) Body With Stand	65.8 x 37.7 x 2.1 inches (1670.6 x 958.7 x 53.9 mm) 65.8 x 40.8 x 12.5 inches (1670.6 x 1036.2 x 316.8 mm)	74.5 x 42.6 x 2.2 inches (1892.8 x 1083.2 x 54.9 mm) 74.5 x 45.8 x 13.3 inches (1892.8 x 1163.1 x 338.8 mm)
Weight Without Stand With Stand	75.8 lbs (34.4 kg) 88.8 lbs (40.3 kg)	95.5 lbs (43.3 kg) 110.5 lbs (50.1 kg)

Environmental Considerations

Operating Temperature: 50°F to 104°F (10°C to 40°C)

Operating Humidity: 10% to 80%, non-condensing

Storage Temperature: -4°F to 113°F (-20°C to 45°C)

Storage Humidity: 5% to 95%, non-condensing

Notes

- Design and specifications are subject to change without prior notice.
- This device is a Class B digital apparatus.
- For information about the power supply, and more information about power consumption, refer to the information on the label attached to the product. On most models, the label is attached to the back of the TV. (On some models, the label is inside the cover terminal.)
- Your TV and its accessories may look different than the product images presented in this manual, depending on the model.
- All drawings are not necessarily to scale. Some dimensions are subject to change without prior notice. Refer to the dimensions before installing your TV. Not responsible for typographical or printed errors.
- To connect a LAN cable, use a CAT 7 (*STP type) cable for the connection. * Shielded Twisted Pair

Decreasing power consumption

When you shut the TV off, it enters Standby mode. In Standby mode, it continues to draw a small amount of power. To decrease power consumption, unplug the power cord when you don't intend to use the TV for a long time.

Dimensions

Back panel detail / Rear view

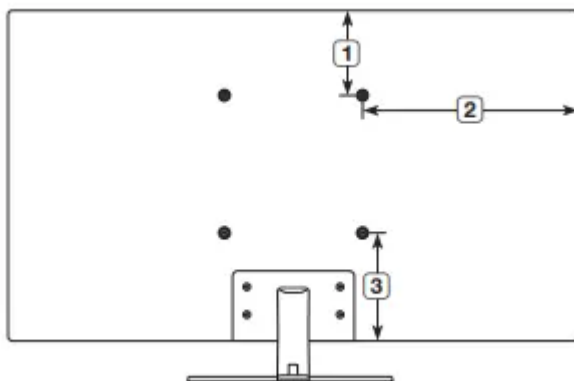

- The displayed image may differ from your TV, depending on the model.

(Unit: inches)

Model name	①	②	③
QN43Q60T / QN43Q6DT	3.3	14.9	10.7
QN50Q60T / QN50Q6DT	5.3	17.9	12.0
QN55Q60T / QN55Q6DT / QN55Q70T / QN55Q7DT	7.9	20.2	11.9
QN58Q60T / QN58Q6DT	6.2	17.4	11.3
QN65Q60T / QN65Q6DT / QN65Q70T / QN65Q7DT	8.8	20.6	12.0
QN75Q60T / QN75Q6DT / QN75Q70T / QN75Q7DT	9.9	25.0	12.0
QN82Q6DT / QN82Q70T / QN82Q7DT	8.8	24.2	16.5
QN85Q60T / QN85Q6DT / QN85Q70T / QN85Q7DT	10.3	25.5	16.5
QN49Q80T / QN49Q8DT	5.4	17.5	11.4
QN55Q80T / QN55Q8DT	8.1	20.2	11.5
QN65Q80T / QN65Q8DT	8.7	20.5	11.8
QN75Q80T / QN75Q8DT	8.3	24.9	13.4
QN85Q80T / QN85Q8DT	8.2	25.4	18.4

Warning

This content is compiled from multiple sources and is provided for reference purposes only. It may not be complete or fully applicable to all situations. If you are unable to resolve your issue, please contact the product manufacturer or an authorized service provider for official support.