

## setting up your dishwasher

Be sure to have your installer follow these instructions closely so that your new dishwasher works properly and that you're not at risk of injury when washing dishes.

### UNPACKING YOUR DISHWASHER

- Once your new dishwasher has been delivered to you, carefully unpack it and check for any damage. If the dishwasher has been damaged, make note of it on the waybill and keep a copy. Do not install the dishwasher, and contact Samsung Customer Service at the number listed below.
- If there is no damage to the product, you can proceed with the installation. If you are going to install it yourself, make sure to read through the installation guide and follow the directions inside.
- After unpacking your dishwasher, keep the packaging out of the reach of children to ensure their safety.

### CHECKING PARTS

When your dishwasher has been unpacked, make sure you've received all the parts shown below. If your dishwasher was damaged during shipping, or if you do not have all the parts, contact **Samsung Customer Service at 1-800-SAMSUNG (726-7864)**

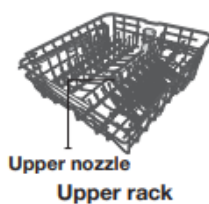
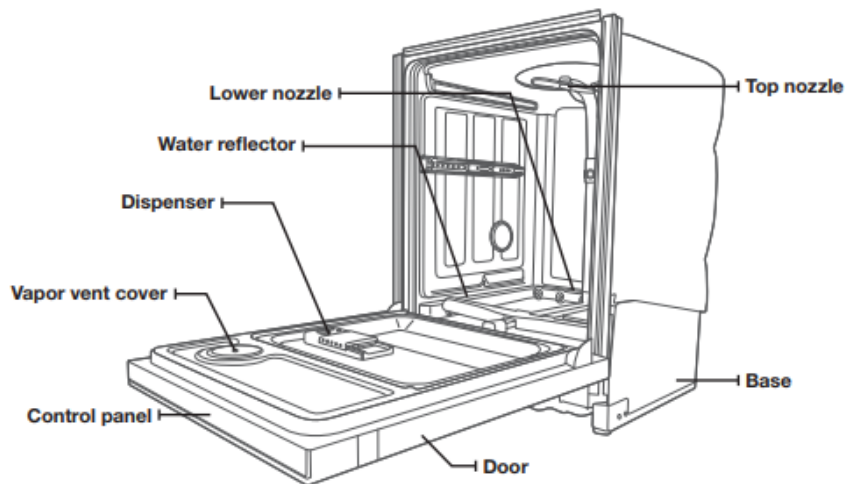



**Accessory parts - User/Installation manual, Installation Kit, Drain Hose, Holder Drain Hose, Hose Clamp, Kick Plate.**

## MEETING INSTALLATION REQUIREMENTS

### Electrical supply and grounding



To prevent the risk of fire, electric shock, or personal injury, all wiring and grounding must be done in accordance with the National Electrical Code ANSI/FNPA, No. 70 Latest Revision and local codes and ordinances. It is the personal responsibility of the appliance owner to provide adequate electrical service for this appliance.



**CAUTION** Never use an extension cord.

When preparing for installation, ensure that your power supply provides:

- An individual 120 Volt, 60Hz branch circuit serving only your dishwasher with a 15 AMP fuse or circuit breaker

Your dishwasher must be grounded. If your dishwasher malfunctions or breaks down, grounding will reduce the risk of electric shock by providing a path of least resistance for the electric current.



**CAUTION** Never connect the ground wire to plastic plumbing lines, gas lines, or hot water pipes.

## GROUNDING INSTRUCTIONS

### For a permanently connected appliance:

This appliance must be connected to a grounded metal, permanent wiring system, or an equipment-grounding conductor must be run with the circuit conductors and then connected to the equipment-grounding terminal or lead on the appliance.

### Water supply

The hot water supply line pressure must be between 20 ~ 120 psi (140 ~ 830 kPa). Adjust the water heater to deliver water between 120 °F (49 °C) ~ 149 °F (65 °C).



Most plumbing supply stores sell water supply lines of various lengths up to 10 feet (305 cm) long.

You can reduce the risk of leaks and water damage by:

- Making water faucets easily accessible.
- Turning off faucets when the dishwasher is not in use.
- Periodically checking for leaks at water supply line fittings.



Before using your dishwasher for the first time, check all connections at the water supply valve and faucets for leaks.

## Flooring

For safety, your dishwasher must be installed on a solidly constructed floor.

Never install your dishwasher on a platform or poorly supported structure.

Your dishwasher must be properly installed in accordance with the Installation Guide before you use it. If you did not receive an Installation Guide with your dishwasher, you can obtain one by visiting our website at [www.samsung.com](http://www.samsung.com).

## using your dishwasher



**WARNING:** To reduce the risk of fire, electric shock, or injury to persons, read the **IMPORTANT SAFETY INSTRUCTIONS** before operating this appliance.



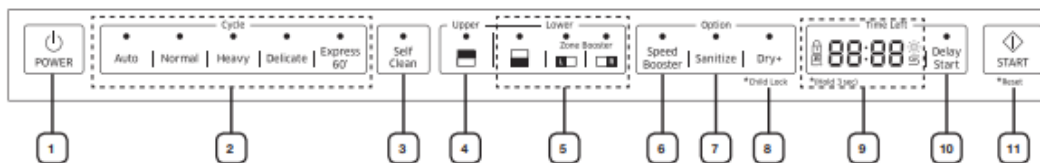

## CONTROL PANEL





### DW80H997 / DW80H995 Series





### DW80H993 Series





<p><b>1. Power</b></p>	<p>When you press the <b>Power</b> button, the light of the most recently finished cycle turns on. When the cycle you selected has finished, all other indicator lights are turned off and the "<b>End</b>" light is illuminated for some minutes. Then, the Power turns off automatically.</p>
<p><b>2. Cycle Selector</b></p>	<p>Select the appropriate wash cycle depending on the soil level of your dishes.</p> <p>After you select a cycle, the Cycle On light for that cycle lights.</p> <p>Also, the Upper and Lower zone lights turn on by default.</p> <p> If you want to change the cycle once it has started, press the Reset button and turn off the dishwasher. Then, turn on the dishwasher again and select a new cycle.</p> <p> The default cycle is Normal.</p> <p> When turning on the dishwasher after it has been reset, the last run cycle is selected by default.</p>
<p><b>3. Self Clean (for some models)</b></p>	<p>Select this option to clean the dishwasher TUB. Run with the dishwasher empty. The <b>Upper</b> and <b>Lower</b> options are turned off by default.</p>
<p><b>4. Upper (for some models)</b></p>	<p>When you select <b>Upper</b>, only the upper rack nozzle is activated. The lower nozzle will not operate.</p> <p>Use this feature to wash a small load of dishes or glasses placed in the upper rack.</p> <p> When you select <b>Upper</b>, place dishes, glasses, etc. in the upper rack only. The dishwasher will not wash items placed in the lower rack.</p> <p>Selecting <b>Upper</b> reduces both the cycle time and the amount of electricity consumed.</p>
<p><b>5. Lower (for some models) / Lower Rack - Only (for some models)</b></p>	<p>When you select <b>Lower (Lower Rack - Only)</b>, only the lower rack nozzle is activated. The upper nozzle will not operate.</p> <p>Use this feature to wash a small load of dishes or glasses placed in the lower rack.</p>

	<p> When you select <b>Lower (Lower Rack - Only)</b>, place items, glasses, etc. in the lower rack only. The dishwasher will not wash items placed in the upper rack.</p> <p>Selecting <b>Lower (Lower Rack - Only)</b> reduces both the cycle time and the amount of electricity consumed.</p> <p> If you want to wash heavily soiled items such as pots and pans, select the <b>Zone Booster</b> option. (This option consumes slightly more water and energy.)</p> <p>Select <b>Zone Booster L</b> option: Applies intensive washing power to the left part of the lower rack.</p> <p>Select <b>Zone Booster R</b> option: Applies intensive washing power to the right part of the lower rack.</p> <p>Select both <b>Zone Booster L &amp; R</b> options: Applies intensive washing power to the whole lower rack.</p> <p> Selecting a Zone Booster option does not turn off the Upper Nozzle</p>
<p><b>6. Speed Booster (for some models)</b></p>	<p>Select this option to reduce washing time.</p>
<p><b>7. Sanitize</b></p>	<p>With the <b>Sanitize</b> option selected, the water temperature is increased to 162 °F (72 °C) in the final rinse cycle for high temperature sanitization.</p> <p>If you select the <b>Sanitize</b> option, the "Sanitize" lamp blinks when the water temperature reaches the sanitary temperature (over 155 °F (68 °C)), and then remains illuminated until the <b>Sanitize</b> option ends. When you open the door or press the <b>Power</b> button, the "Sanitize" lamp turns off.</p> <p> You cannot select the <b>Sanitize</b> option if you select the Delicate cycle.</p> <p> The Sanitize feature operates in accordance with NSF/ANSI Standard 184 for Residential Dishwashers. Certified residential dishwashers are not intended for licensed food establishments. Your dishwasher is NSF Certified.</p> <p>The cycle that is NSF certified is the <b>Normal</b> Cycle with the Sanitize option selected.</p>



<p><b>8. Dry+ / Child Lock</b></p>	<p>Use this option when you want to dry your dishes more completely. The temperature rises to 162 °F (72 °C) in the final rinse cycle and dry time is increased.</p> <p>If you select the this option, electricity consumption is increased. The next time you use the dishwasher, the <b>Dry+</b> option will be selected automatically and applied to the next cycle. You can turn off the <b>Dry+</b> option by pressing the <b>Dry+</b> button.</p> <p> You cannot select the <b>Dry+</b> option if you select the Delicate cycle.</p> <p><b>*Child Lock</b> : This option allows you to lock the buttons on the control panel - except the <b>Power</b> button - so children cannot accidentally start the dishwasher by pressing the buttons on the panel. Only the <b>Power</b> button remains active.</p> <p><b>To lock or unlock</b> the buttons on the control panel, press and hold the <b>Dry+/Child Lock</b> button for three (3) seconds.</p> <ul style="list-style-type: none"> <li>- When the Power is On : Press and hold the "<b>Dry+/Child Lock</b>" button for three (3) seconds.</li> <li>- When the Power is Off : Push the <b>Power</b> button first, and then press and hold the "<b>Dry+/Child Lock</b>" button for three (3) seconds.</li> <li>- Child Lock remains active until you turn it off. You cannot select cycles or options or start the dishwasher when Child Lock is on.</li> </ul>
<p><b>9. Display</b></p>	<p>Displays cycle time and remaining hours and minutes, Delay Start hours, and Information codes.</p> <p>If a problem occurs during operation, an information code appears with a warning sound.</p> <p>Refer to the information codes page.</p> <p> Child Lock indicator</p> <ul style="list-style-type: none"> <li>- Turns on if the Child Lock is set (or the dishwasher is in the standby or pause modes).</li> <li>- Turns off while the dishwasher is operating.</li> <li>- When Child Lock is on, the Child Lock indicator blinks for several seconds if any button except the Power button is pressed.</li> </ul> <p> Self Clean indicator (for some models)</p>

	<ul style="list-style-type: none"> <li>- Turns on when the Self Clean option is enabled (or the dishwasher is in the standby or pause modes), but turns off while the dishwasher is operating.</li> <li>- Blinks for 5 seconds every 20 to 22 cycles.</li> <li>- The cycle counter disappears when the Self Clean operation is complete or when the dishwasher reaches the 23rd cycle without the Self Clean cycle being used. (The Reset or Self Clean operation is not counted by the cycle counter.)</li> </ul> <p style="text-align: center;"> Rinse Refill indicator</p> <ul style="list-style-type: none"> <li>- Turns on if the dishwasher runs out of rinse aid (or the dishwasher is in the standby or pause modes).</li> <li>- Turns off while the dishwasher is operating</li> </ul> <p style="text-align: center;"> Lack of salt indicator (*applicable models only)</p> <ul style="list-style-type: none"> <li>- Turns on when the water softener runs out of salt. (or the dishwasher is in the standby or pause modes.)</li> <li>- Turns off while the dishwasher is operating</li> </ul>
<p><b>10. Delay Start</b></p>	<p>Delay a cycle for up to 24 hours in one-hour increments. To increase the delay start time, press or hold the <b>Delay Start</b> button. The hour displayed indicates the time at which the wash will be started.</p> <ul style="list-style-type: none"> <li>- After setting the delay time, press the <b>Start</b> button, and then close the door to start the cycle.</li> <li>- If you want to change the delay time once the dishwasher has started, press the <b>Reset</b> button and turn off the dishwasher. Then, turn on the dishwasher again and select a new cycle with a new delay setting.</li> </ul>
<p><b>11. Start</b></p>	<p>To start a cycle, press the Start button before closing the door.</p> <p><b>*Reset</b> : To cancel a currently running cycle and drain the dishwasher, press and hold the <b>Start</b> button for three (3) seconds.</p> <p>Once the dishwasher is reset, select a cycle and option, and then press <b>Start</b> to restart the dishwasher.</p>



 You can select options (Self Clean, Upper, Lower, Speed Booster, Sanitize, Dry+, Delay Start) before starting a cycle. If you change the cycle after selecting an option, the original cycle is reset.

 To prevent the touchpad from losing response sensitivity, follow these instructions:

- Touch the center of each keypad using one finger. Do not push.
- Clean the touch control's surface regularly with a soft, damp cloth.
- Be careful not to touch more than one touch key pad at a time, except as directed.

 When you pause a cycle by opening the door during operation, press the **Start** button before closing the door to continue the cycle.



## CYCLE SELECTOR

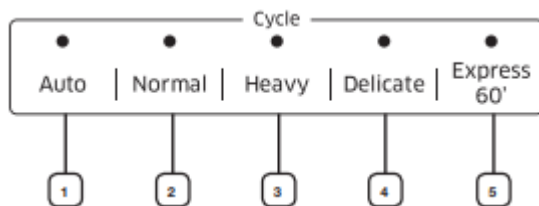

<b>1. Auto</b>	This cycle detects the level of soil and automatically initiates the optimal cycle after a few minutes of operation.
<b>2. Normal</b>	Use this cycle for normally soiled dishes. The energy-usage label is based on this cycle.
<b>3. Heavy</b>	Use this cycle for heavily soiled dishes
<b>4. Delicate</b>	Use this cycle for soiled fragile items such as glasses. You cannot select the <b>Zone Booster</b> , <b>Dry+</b> , or <b>Sanitize</b> option if you select this cycle.
<b>5. Express 60'</b>	Use this cycle when you need to wash dishes quickly. It takes about 1 hour. You cannot select the <b>Speed Booster</b> or <b>Zone Booster</b> option if you select this cycle.

## PROGRESS DISPLAYS

### DW80H997 Series



### DW80H995 Series



<b>1 Wash</b>		When the dishwasher is in a wash portion of a cycle, the first arrow light is illuminated and the remaining time is displayed.
<b>2 Rinse</b>		When the dishwasher is in a rinse portion of a cycle, the second arrow light is illuminated and the remaining time is displayed.
<b>3 Dry</b>		When the dishwasher is in a drying portion of a cycle, the third arrow light is illuminated and the remaining time is displayed.
<b>4 Clean</b>		After the dishwasher has completed all portions of a cycle, all other indicator lights are turned off. The dishwasher chimes and <b>End</b> is displayed for several minutes.



When the dishwasher starts a cycle, the light that corresponds to the current operation turns on to show the progress of the cycle.



## DW80H993 Series

On DW80H993 series dishwashers, the Pocket LED lights when the dishwasher operates.

### BASIC GUIDELINES

**1.** Open the door and load your dishes (see page **16 ~ 19**).

- Place dishes into the upper and lower racks, unless you have selected the **Upper** or **Lower (Lower Rack - Only)** option.
- Remove any food remains from the dishes before placing them in the rack(s).
- After placing the dishes into the racks, turn the upper nozzles to make sure none of the dishes will block nozzle rotation.
- Make sure the dishes will not prevent the detergent dispenser from opening.

**2.** Add detergent to the dispenser (see page **20**).

- Make sure to use only automatic dishwasher detergent.
- Refer to "**Using detergent**" on how to add detergent.

**3.** Press the **Power** button.

- When you press the **Power** button, the cycle light of the most recently finished cycle lights up.
- If "Rinse Refi II" Indicator is illuminated, you should refill the rinse aid dispenser to improve washing and drying performance.

**4.** Select an appropriate cleaning cycle depending on the soil level of the dishes. (see pages **12** and **24**).

- Press the appropriate Cycle button.
- When you press a Cycle button, the cycle indicator light is illuminated.
- For information about selecting a cycle according to the soil level of the dishes, see "**Cycle selector**".

**5.** Press the **Start** button, and then close the door.

- Push the racks back so that they are in place, and then press the **Start** button and close the door.
- Make sure to close the door firmly. If the door is slightly ajar, the selected cycle will not start automatically.
- The dishwasher will start draining after a few seconds, and then start the cycle you selected.

**6.** When the wash cycle is completed.

- The **"End"** light illuminates and the dishwasher sounds a chime.
- The power is automatically turned off after a few minutes.



If you want to load more dishes or pause the dishwasher while it is already running, make sure to open the door slowly and carefully as there is a possibility of injury from the hot steam or water inside the dishwasher.

(If the door is opened while the dishwasher is running, a safety mechanism is activated and stops the cycle.) To resume operation, press the **Start** button, and then close the door.

Note that adding dishes several minutes after the dishwasher started operating may affect the performance.



You should use rinse aids for better drying performance. You can further improve drying performance by also selecting the **Dry+** option.

## Touch Controls

Touch controls allow you to operate the dishwasher easily.

- They are convenient to operate, requiring only a soft touch.
- Have a simple and stylish design.
- Are easy to clean.

**If you have children or you want to clean the Control Interface, we recommend activating the Child Lock feature to lock the control buttons.**

- Children will not be able to accidentally start the dishwasher by touching the controls with this option selected.
- If a cycle is running, the buttons will not respond. (except the **Power** button and Child Lock & Reset options)
- If dishwasher is off, only the **Power** button responds.

## Delay Start

When you select the Delay Start option, your dishwasher will begin the selected cycle when the delay time expires.

## The Water Reflector Interference Alarm:

- The water reflector interference feature automatically detects obstacles in the tub. If it detects an obstacle, the display blinks and the dishwasher chimes for several minutes. If an obstacle is detected at the end a cycle, End blinks for several minutes.
- Remove any obstacles in the bottom of the dishwasher.

## Setting Mode

The Setting Mode lets you change the dishwasher's sound setting and LED brightness setting. To enter the Setting mode, press the **Delay Start + Sanitize** buttons for 3 seconds while the dishwasher is on. Press the **Sanitize** button to select a sub-setting menu and press the **Delay Start** button to change a setting.

- **Sound Setting:** Press the Sanitize button until "S on" or "SoFF" is displayed. To change the setting, press the Delay Start button. "SoFF" means that the sound is off for all cycles. The dishwasher maintains the Sound Setting you have selected until you change it.

- **Pocket LED Brightness Setting:** Press the **Sanitize** button until "B0 ~ B5" is displayed. The higher the number, the brighter the LEDs. To change the setting on an H9930 series dishwasher, press the **Delay Start** button.



When using the dishwasher, try to arrange the dishes properly as described on page 16.

- You should remove food remains such as bones, fruit seeds, etc. and any other waste such as toothpicks, paper, etc. from the dishes as these may cause damage to the dishes, create noise, or cause the dishwasher to malfunction.
- Select the appropriate cycle depending on the level of soil and the type of dishes.
- Use only the proper amount of detergent and rinsing agent.



Do not wash the following items

- **Acrylic or Aluminum items:** Acrylic and aluminum items can discolor dishes with printed gold rim decoration and mar other items.
- **Dishes treated with adhesive:** Treated plastics can come apart. Wood, ivory, copper, and tin glued to dishes can come loose.
- **Plastics with a temperature tolerance less than 194 °F (90 °C):** Thin plastics wash and dry poorly, and may be damaged by elevated wash temperatures.
- **Tin:** Tin should be washed by hand and dried immediately as it can rust.
- **Wooden utensils:** Wooden items can crack.

## ADJUSTING THE ANGLE OF THE PLATE SUPPORTS

You can adjust the angle of the tines in the upper rack to three different positions to match the size and shape of your dishes. To adjust the tines, grasp the handle at the back of the rack, and then push it left or right. See the illustration below.

In the lower rack, you can easily fold down the fold-down tines to make room for large items such as pots and pans. Remove the rack from the dishwasher, and then fold down the tines one at a time. See the illustration below.

### Upper rack

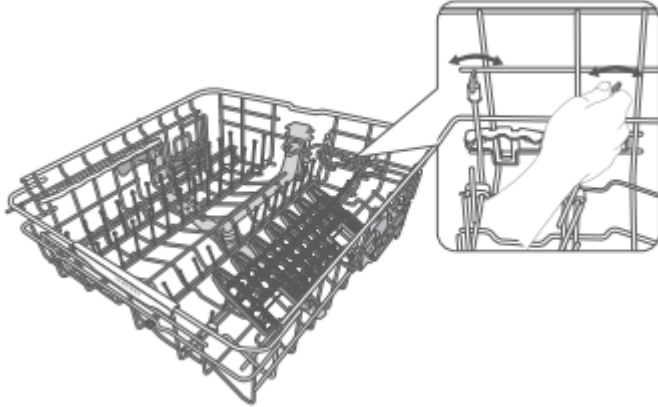

### Lower rack



## ADJUSTING THE HEIGHT OF THE UPPER RACK

You can adjust the height of the upper rack in your Samsung dishwasher so that the lower rack can accommodate larger sized dishes. Depending on where you set the upper rack height, the lower rack can accommodate plates up to 12 in. (30 cm) in diameter and the upper rack can accommodate plates up to 8 in. (20 cm) in diameter.

1. To lower the upper rack by 2 in. (5 cm), pull the adjust handles located at the left and right sides of the upper rack, and then push the upper rack downwards slightly at the same time.
2. To raise the upper rack, just pull the upper rack upwards. The adjuster handle will latch and the upper rack will move to the high position.

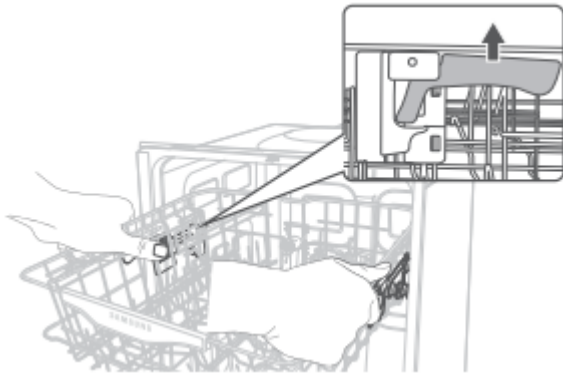

We recommend adjusting the height of the upper rack before loading dishes into the rack. If you adjust the the rack after loading the dishes, you may damage the dishes. If you do not adjust with left and right handle together, the dishwasher door may not close properly.

Pull out the upper rack from the tub until it is fully revealed before adjusting the upper rack.

## LOADING THE LOWER RACK

Load cookware (pots, pans, etc.), up to 12 in. (30 cm) in diameter into the lower rack. The lower rack has been especially designed for dinner dishes, soup bowls, plates, pots, lids, and casserole dishes.

Load your plates into the center column of the rack so that their top sides face each other. Load large items such as pans and pots into the dishwasher so their inner cavities face downwards. We recommend loading cups, stemware, and small plates into the upper rack.

See the recommended loading patterns below.



**8 place setting**



**10 place setting**



**12 place setting**

## Loading large items into the Zone Booster Areas

You can load large items such as pots and pans into the left and/or right sides of the lower rack - the Zone Booster areas - for more effective cleaning. When you select the Zone Booster option, an additional, powerful jet is activated and directed at items in the Zone Booster areas. Make sure pot handles and other items do not interfere with the rotation of the nozzles and the water reflector.



## LOADING THE UPPER RACK

The upper rack has been designed for small plates, mugs, glasses, and plastic items marked "dishwasher safe". Load your plates into the dishwasher so that their top sides face each other.

Make sure the loaded dishes do not interfere with the rotation of the nozzle which is located at the bottom of the upper rack. (Check this by rotating the nozzle by hand.)

When loading dishes, pull the upper rack out sufficiently so you can load it without striking the counter above.



**8 place setting**



**10 place setting**



**12 place setting**

## Using the glass support

You can load cups or glasses onto the glass support. This is also very convenient for washing wine glasses. Hang your wine glasses onto the pegs of the glass support.

You can fold the glass support back when it is not being used.

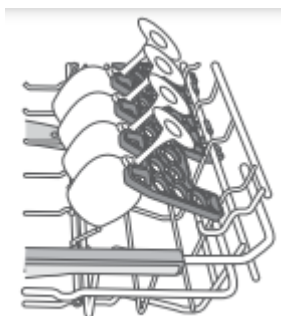

## USING THE 3RD (CUTLERY) RACK (FOR SOME MODELS)

### Loading the cutlery rack



<Place items randomly or regularly.>

In addition to the standard cutlery basket in the lower rack, some models come with a cutlery rack. The cutlery rack is best suited for flatware and cooking or serving utensils. You can place cutlery and utensils randomly or regularly on the cutlery rack.

Heavily soiled utensils or items with baked on foods should be placed in the lower cutlery basket for the most effective cleaning.

### Removing the Cutlery Rack

The entire cutlery rack can be removed if more space is needed on the upper rack for larger items.

### Loading the cutlery pad



<Place items randomly or regularly.>

Some models come with a removable, foldable cutlery pad along with a cutlery rack. To use, place the pad on the cutlery rack. and then place cutlery and serving and cooking utensils on the pad in a random or regular fashion. After a wash cycle is complete, and the cutlery and utensils are dry, you can fold the pad and carry the cutlery and utensils in the pad to their storage locations.



**WARNING** Use caution when folding and moving the rack with a long thin item inside the pad. The item may fall out in this process, causing physical injury.



It is advisable not to move the pad while it is wet. Wait until the pad is dry.

The pad dries quickly after a wash cycle when exposed to air for a few minutes.



## USING THE CUTLERY BASKET

The cutlery basket consists of two compartments.

You can place each knife, spoon, or fork separately into the cutlery stands in the basket's covers to prevent chipping and discoloration.



DO NOT let any item extend through the bottom.

1. Forks
2. Tea spoons
3. Dinner spoons
4. Knives
5. Serving spoons and Serving forks
6. Remaining items

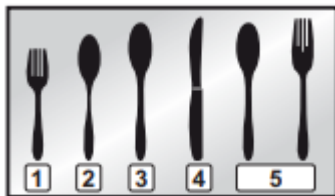

5 Serving spoons and Serving forks

6 Remaining items



8 place setting



10 place setting

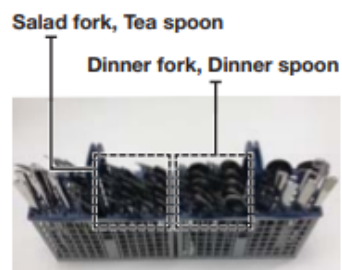

12 place setting

The cutlery stands as seen from above with the suggested placement of cutlery items. Match the numbers in the diagram to the numbers in the list of cutlery items above.

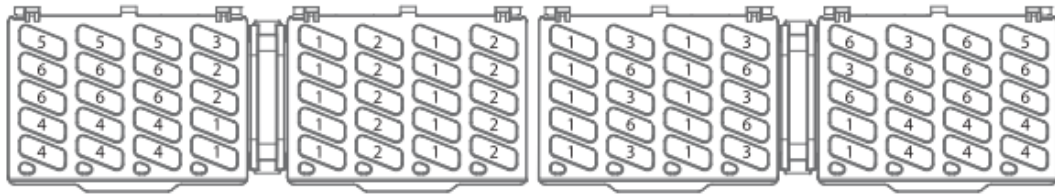

You can use the cutlery basket with the covers open. Refer to the illustration to the right.

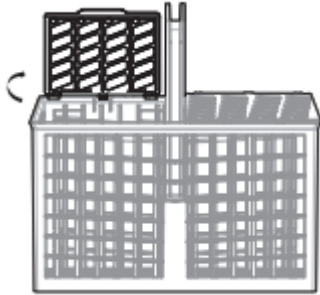

## USING DETERGENT

All dishwasher cycles require detergent in the detergent compartment.

Add the correct amount of detergent for the selected cycle to ensure the best performance.



Use dishwasher detergent only. Regular detergent produces too much foam, which may decrease the dishwasher's performance or cause it to malfunction.



Do not swallow dishwasher detergent. Avoid breathing in the fumes. Dishwasher detergent contains irritants and caustic chemicals that can induce respiratory conditions. If you have swallowed dishwasher detergent or inhaled the fumes, seek medical attention immediately.



Keep dishwasher detergent out of the reach of children.

## Filling the detergent dispenser

1. Open the detergent dispenser flap by pushing the detergent dispenser release catch.



The flap is always open at the end of a dishwashing cycle

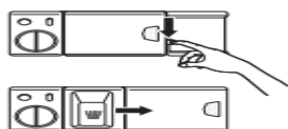

2. Add the recommended amount of detergent to the main wash detergent compartment.

3. Close the flap by sliding it to the left and then pressing it down.



4. For better cleaning result, especially if you have very dirt items, pour a small amount (about 1/2 of an ounce or 15 g) of detergent onto the door.

The additional detergent will activate during the pre-wash phase.

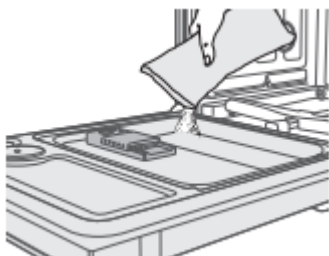

The cover opens automatically to dispense the detergent during the wash

CYCLE	AMOUNT OF DETERGENT	
	Main wash dispenser	Onto the door for pre-wash
Auto, Normal	3/4 oz (20 g)	1/3 oz (10 g)
Heavy, Express 60'	1 oz (30 g)	1/2 oz (15 g)
Delicate	3/4 oz (20 g)	1/5 oz (5 g)



The numbers inside the dispenser refer to grams

## USING RINSE AID

### Filling the rinse aid reservoir

When the Rinse Refill indicator lights up on the control panel, refill with rinse aid. Your dishwasher has been designed to use liquid rinse aid only.

Using a powdered rinse aid will clog the reservoir opening and cause the dishwasher to malfunction.

Rinse aid improves the drying performance of the dishwasher.



Do not add regular detergent to the rinse aid reservoir.

1. Remove the rinse aid reservoir cap by rotating it counterclockwise.

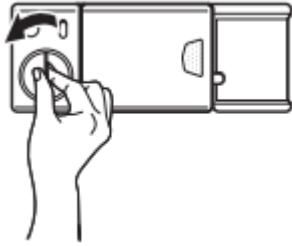

2. Fill the rinse aid reservoir with rinse aid.



Use the viewing port when filling the rinse aid reservoir.



Do not fill the reservoir above the full level indicator. Excess rinse aid can overflow during the wash cycle.

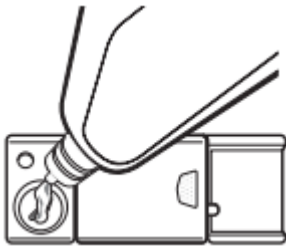

3. Turn the rinse aid indicator dial to a number between 1 and 6. The higher the number, the more rinse aid the dishwasher uses. If you are unable to rotate the rinse aid dial easily, try using a coin.

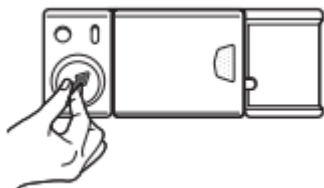

4. Close the rinse aid reservoir cap by rotating it clockwise

## cleaning and maintaining your dishwasher

Keeping your dishwasher clean improves its performance, reduces unnecessary repairs, and lengthens its life.

## CLEANING THE EXTERIOR

It's best to clean spills on the outside of your dishwasher as they occur. Use a soft, damp cloth on the control panel to gently wipe away spills and dust. Do not use benzene, wax, thinner, chlorine bleach, or alcohol. These materials may discolor the door panel and other outer surfaces and cause stains. Do not clean the dishwasher by sprinkling water over it and avoid letting water come into contact with any of the electrical parts.



If your dishwasher has a stainless steel door panel, you can clean it with a stainless steel cleaner for Home Appliances or similar product using a clean, soft cloth.

## CLEANING THE INTERIOR

Clean the interior of your dishwasher periodically to remove any dirt or food particles. Wipe the inside of the dishwasher and the inner part of the door with a wet dishcloth. We recommend filling the detergent dispenser with dishwasher soap, and then running the dishwasher empty periodically using the **Self Clean** option. To keep the cutlery pad clean, turn it over. This will keep your dishwasher clean.

If white spots and odor are still present in your dishwasher, run the **Self Clean** option with the dishwasher empty and without detergent until it flushes. Then, interrupt the cycle and put an 8 ounce cup of white vinegar into the lower basket. Close the dishwasher and let the cycle finish.



Do not remove the tub front seal (the long rubber seal enclosing the opening of the dishwasher).

## CLEANING THE NOZZLES

If your dishwasher does not seem to be cleaning adequately or the nozzles seem clogged, you can clean each of the nozzles. When removing the nozzles, take care as they may break.

### Upper nozzle

1. Pull the upper rack towards the front
2. Check whether the nozzle holes are clogged by food particles.
3. If cleaning is needed, remove the nozzle.
4. To remove the nozzle, unfasten and remove the nut, and then remove the nozzle.
5. Clean the nozzle, re-insert it, and fasten the nut.
6. When fastening the nut, turn it firmly by hand.
7. Check whether the nozzle is engaged correctly by rotating it by hand.

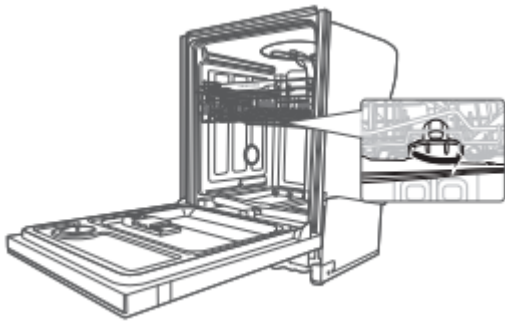

## Top nozzle

1. Check whether the nozzle holes are clogged by food particles.
2. If cleaning is needed, remove the nozzle.
3. To remove the nozzle, pull out the upper rack first, unfasten the nozzle cap by turning it counterclockwise, and then remove the upper nozzle.
4. Clean the nozzle, re-insert it, and then fasten the nozzle cap to the nozzle by turning the cap clockwise.
5. Check whether the nozzle is engaged correctly by rotating it by hand.

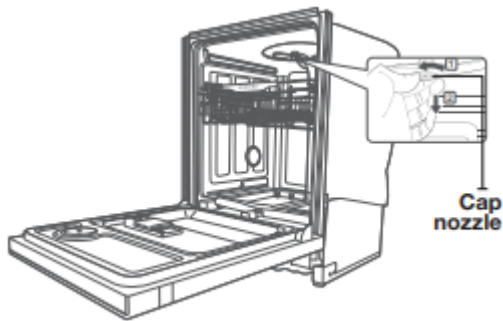

## CLEANING THE FILTER

1. Remove the lower rack first.
2. Rotate the filter handle counterclockwise to unfasten the filter compartment door.



3. Remove the filter door, and then the flat micro filter underneath.



4. Remove any dirt or other remains from the micro filter and the filter door, and then rinse them under running water.



5. Re-install the flat micro filter, and then the filter door.

6. Rotate the filter door handle clockwise to lock the filter door.



Once a month, clean the filter for better washing performance.



If the filter door does not close properly, cleaning performance will be decreased.

## STORING YOUR DISHWASHER

If you need to store your dishwasher for an extended period of time, first drain and disconnect it. If you leave water in the hoses and internal components, you can damage the dishwasher.

After draining and disconnecting the dishwasher, be sure to turn off the water supply valve and circuit breaker.

## troubleshooting

**CHECK THESE POINTS IF YOUR DISHWASHER...**

PROBLEM	POSSIBLE CAUSE	SOLUTION
<b>Will not start</b>	The door is not closed completely.	<p>Check if the door is latched and closed completely. Check whether the Upper Rack is properly joined with Duct Nozzle. Also, Check imbalance assembly of the Upper Rack.</p> 
	No cycle is selected.	Select a proper cycle
	The power cable is not connected.	Connect the power cable properly.
	The water supply does not work.	Check if the water supply valve is open.
	The Control Panel is locked	Unlock the child lock, (See page <b>10</b> .)
	A circuit breaker is open.	Reset the circuit breaker
<b>It's taking too long with an operation or cycle.</b>	Cold water is being supplied.	Check if the water supply line is connected to a hot water supply. (Additional time is required to heat cold water.)
<b>There are food particles remaining on dishes. (Not</b>	The cycle selected was unsuitable.	Select a cycle according to the number and soil level of the dishes, as directed in this manual

cleaning properly.)	The water temperature is low.	Connect the water supply line to a hot water supply. For best performance, the temperature of the supplied water should be 120 °F (49 °C).
	Low water pressure.	The water pressure should be between 20 and 120 psi (140 ~ 830 kPa).
	The water is too hard	Use a commercial dishwasher cleaner. Use high-quality, fresh detergent with rinse aid. Clean the filter at least once per month. (See page <b>23</b> .) Use a water softener additive designed for dishwashers.
	Dishwasher detergent was not used.	Use automatic dishwasher detergent. We recommend a powder or gel type dishwasher detergent.
	Detergent remains in the dispenser.	Make sure large items such as cookie sheets, cutting boards, or containers, etc. are not blocking the detergent dispenser and preventing it from opening properly. Rearrange the dishes so they do not interfere with detergent dispenser operation.
	There is no rinse aid.	Check the dispenser and add rinse aid. Use liquid type rinse aid.
	A nozzle is clogged.	Clean the nozzle. See pages <b>22</b> and <b>23</b> .
	The dishes are improperly loaded.  Too many dishes have been loaded.	Rearrange the dishes so they do not interfere with nozzle rotation and detergent dispenser operation. Load only an appropriate number of dishes. Load your dishes as recommended. (See page <b>16</b> .)

	<p>Filter could be clogged.</p> <p>(Food soils remain on the filter.)</p>	<p>Scrape food from dishes prior to loading. (Do not prerinse.)</p> <p>Clean the soils and filters. (See page 23.)</p>
<p><b>Leaves glasses with a light film.</b></p>	<p>The water supplied is soft and too much detergent was used.</p>	<p>Underload the dishwasher and use a rinse aid to minimize this.</p>
	<p>Aluminum dishes were included in the wash load.</p>	<p>Remove the marks on the dishes using a low sensitivity cleaner.</p>
<p><b>Leaves a yellow or brown film on the inside of the dishwasher.</b></p>	<p>This is caused by coffee and tea soils.</p>	<p>Remove the soils using a spot cleaner</p>
<p><b>Does not dry dishes well.</b></p>	<p>There is no rinse aid in the dispenser</p>	<p>Check the dispenser and add rinse aid.</p> <p>Use a liquid type rinse aid.</p>
	<p>The temperature of the water is low when the dishwasher is running.</p>	<p>Connect the water supply line to a hot water supply.</p> <p>Use rinse aid with the Sanitize option.</p>
		<p>Proper loading of items can affect drying.</p> <p>Load your dishes as recommended.</p>



	Too many dishes have been loaded.	(See page <b>16</b> .)
	Glasses and cups with concave bottoms hold water. This water may spill onto other items when unloading.	After finishing the cycle, empty the lower rack first and then the upper rack. This will prevent water dripping from the upper rack onto the dishes in the lower rack.
<b>Has a bad odor.</b>	Water was left over from an incomplete cycle.	Insert detergent without loading dishes, and run the Normal cycle to clean the dishwasher.
	The Drain Hose is obstructed	Contact a qualified service technician to remove any obstruction from the drain hose.
	The dishwasher is not used daily or soiled dishes are left in unit too long.	With the dishwasher empty and no detergent, place a glass with 8 ounces of vinegar upright into the lower rack, and then run a Normal cycle.
<b>Is too noisy.</b>	Sound is generated when the dispenser cover is open and the drain pump is operating in an early stage.	This is normal operation.



	The dishwasher is not level.	Ensure the dishwasher is level.
	Foreign material (a screw, a plastic piece) is in the pump chamber.	Contact a qualified service technician to remove foreign material from the pump chamber.
	There is a 'chopping' sound because a nozzle is bumping against the dishes.	Rearrange the dishes
<b>Does not have a smoothly rotating nozzle.</b>	The nozzle hole is clogged with food particles.	Clean the nozzle hole. See pages <b>22</b> and <b>23</b> .
	The nozzle is blocked by a dish or pot and cannot rotate.	After placing the dishes into the racks, rotate the nozzles by hand to check whether any of the dishes interfere with them.
<b>Water won't pump out of the dishwasher.</b>	The drain is clogged.	Contact a qualified service technician to remove any obstruction from the drain hose and drain hole inside the sump. After that check the drain pump operation.
<b>Has a bent upper rack after loading dishes.</b>	The dishes are not loaded properly	Load your dishes as recommended. (See page <b>16</b> .)

## **INFORMATION CODES**

The Control Panel displays information codes to help you understand what is occurring with your dishwasher.



Code	Action
OC	<p><b>Over-level water check</b></p> <ul style="list-style-type: none"> <li>• Functional check. Close the water supply valve and go to your house circuit breaker panel, set the dishwasher's circuit breaker switch to off, and then contact an authorized Samsung service centre.</li> </ul>
LC	<p><b>Leakage check</b></p> <ul style="list-style-type: none"> <li>• If a water supply valve connection leak occurs, close the water supply valve and go to your house circuit breaker panel, set the dishwasher's circuit breaker switch to off, and then contact the installer to fix. If the problem continues, contact an authorized Samsung service centre</li> </ul>
4C	<p><b>Water supply check</b></p> <ul style="list-style-type: none"> <li>• Check if the water supply valve is closed, the water supply is suspended, or the water inlet valve or line is frozen or clogged by foreign particles. If the problem continues, close the water supply valve, and then contact an authorized Samsung service centre</li> </ul>
5C	<p><b>Drain check</b></p> <ul style="list-style-type: none"> <li>• After closing the water supply valve, check whether the drain hose is clogged or folded. Also, check whether drain hole inside sump is clogged. If the problem continues, contact an authorized Samsung service centre.</li> </ul>
HC	<p><b>High temperature heating check</b></p> <ul style="list-style-type: none"> <li>• Functional check. With the dishwasher empty, add detergent, and then run a cycle. If the problem continues, go to your house circuit breaker panel, set the dishwasher's circuit breaker switch to off, and then contact an authorized Samsung service centre</li> </ul>
3C	<p><b>Pump operation check</b></p> <ul style="list-style-type: none"> <li>• Functional check. Turn off the dishwasher and try to start it again. If the problem continues, contact an authorized Samsung service center.</li> </ul>

For any codes not listed above, call 1-800-SAMSUNG (726-7864)



## SPECIFICATIONS

<b>Model</b>	<b>DW80H9970US / DW80H9950US / DW80H9930US</b>		
<b>Type</b>	Built-in Dishwasher	<b>Wash capacity</b>	15 place setting
<b>Power</b>	120 V / 60 Hz AC only, 15 A circuit breaker	<b>Used water pressure</b>	20 ~ 120 psi (140 ~ 830 kPa)
<b>Rated power usage</b>	Wash Motor : 60 ~ 100 W Heater : 1100 W		
<b>Dimensions</b> (Width x Depth x Height)	23 $\frac{7}{8}$ x 25 x 33 $\frac{7}{8}$ in. (605 x 636 x 860 mm)		
<b>Weight</b>	Unpacked 97 lb (44 Kg) [DW80H9970US / DW80H9950US / DW80H9930US]		

### Warning

This content is compiled from multiple sources and is provided for reference purposes only. It may not be complete or fully applicable to all situations. If you are unable to resolve your issue, please contact the product manufacturer or an authorized service provider for official support.