

## Operating Instructions

### How to install features.

*(Not all features are on all models.)*

### About the shelves and bins.

*(Not all features are on all models.)*

### Rearranging the Shelves

#### Refrigerator Shelves:

*To Remove*

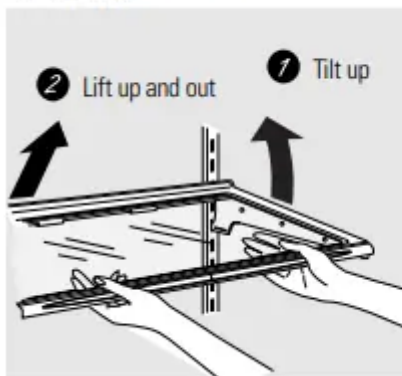

*To Replace*

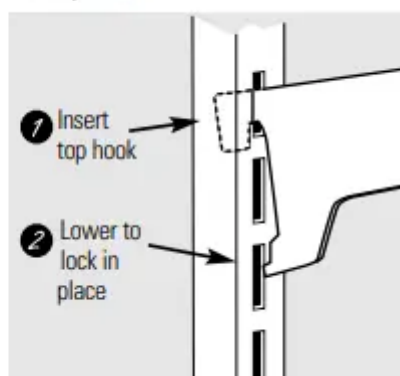

#### Freezer Pan:

To Remove

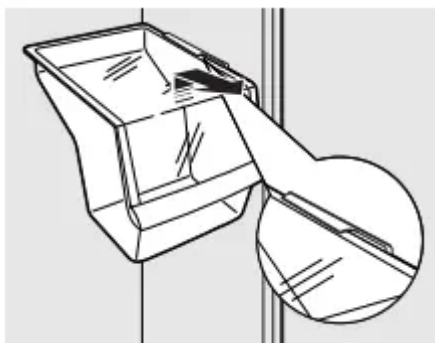

Remove the pan by pulling it forward, lifting up the front and sliding it past the stop location

#### Freezer Shelves

To Remove

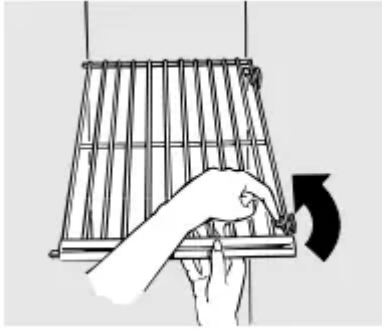

### **Slide-Out Spillproof Shelf (on some models)**

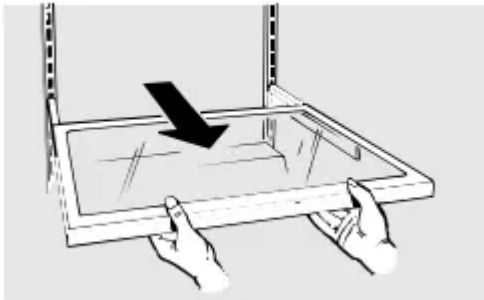

The slide-out spillproof shelf allows you to reach items stored behind others. The special edges are designed to help prevent spills from dripping to lower shelves.

**NOTE:** Make sure you push the shelves all the way back in before you close the door.

### **Spillproof Shelves (on some models)**

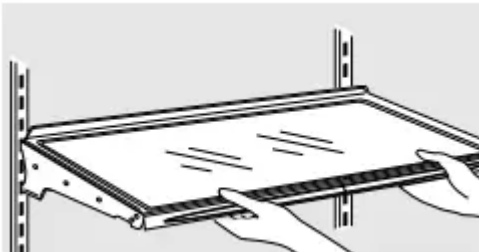

Spillproof shelves have special edges to help prevent spills from dripping to lower shelves.

### **About the crispers and pans.**

*(Not all features are on all models.)*

### **Adjustable Humidity Crispers and Snack Pan (on some models)**

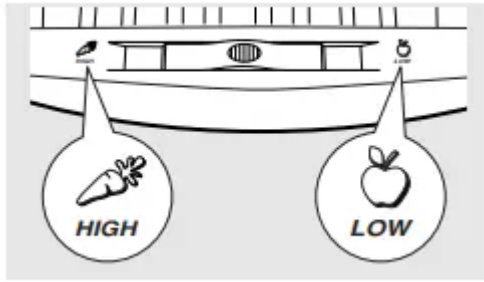

Slide the control all the way to the High setting to provide high humidity recommended for most vegetables.

Slide the control all the way to the Low setting to provide lower humidity levels recommended for most fruits.

### **Convertible Meat Pan (on some models)**

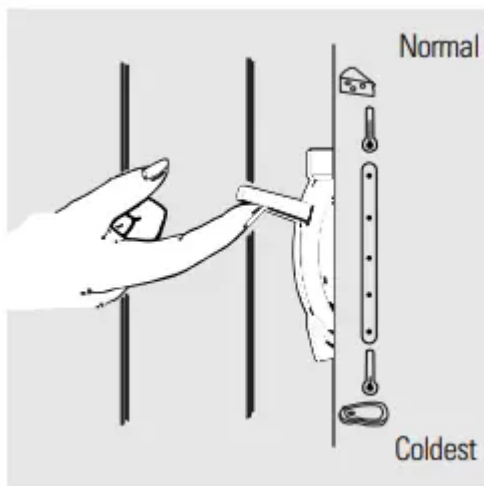

The convertible meat pan has its own cold air duct to allow a stream of cold air from the freezer compartment to flow around the pan.

The variable temperature control regulates the air flow from the freezer compartment.

Set control lever up to convert the pan to normal refrigerator temperature and provide extra vegetable storage space. Cold air duct is turned off. Variable settings between these extremes can be selected.

Set control lever down to the coldest setting to store fresh meats. If lever is left in meat position for a long period of time, some frost may form on the inside of the pan.

### **Crisper Removal**

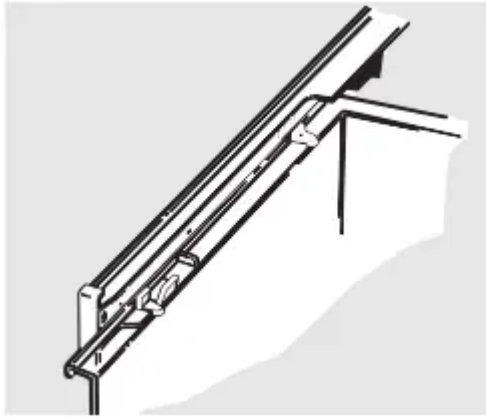

*When replacing the crispers, make sure you slide them through the crisper guides.*

Crispers can easily be removed by tilting up slightly and pulling past stop location.

If the door prevents you from taking out the crispers, the refrigerator will need to be rolled forward until the door opens enough to slide the crispers out. In some cases, when you roll the refrigerator out, you will need to move the refrigerator to the left as you roll it out.

## **About the controls on the refrigerator**

Your controls will look like one of the following:

### **Startup Steps for Proper Temperature Control**

STEP 1—Set Fresh Food Control on “5.”

STEP 2—Set Freezer Control on “5.”

STEP 3—WAIT 12 HOURS for temperature to stabilize.

STEP 4—If a change is needed, move the control one number at a time and allow 12 hours for temperature to stabilize.

**NOTE:** Turning the refrigerator to the 0 (off) setting via the controls does not shut off electrical power to the refrigerator.

Control settings will vary based on personal preferences, usage and operating conditions and may require more than one adjustment.

### **To Change Temperature Control Setting with Touch Pads:**

Freezer setting is on the left side of the display.

Refrigerator setting is on the right side of the display.

- Press the Warmer or Colder pad for compartment and direction desired.
- Present control setting number will illuminate.
- Each time the pad is touched, compartment setting changes one number.

A display of 1 is warmest and 9 is the coldest setting

## **To Turn Cooling Off:**

To stop cooling in the refrigerator and freezer compartments, first repeatedly press the Warmer pad for the freezer until its display continuously flashes "1". Then, using the refrigerator control, repeatedly press Warmer until both displays flash "0". "0" in both displays turns off the cooling system. On some models, it may be necessary to set only one control to 0 to turn off cooling in both compartments

NOTE: Turning the refrigerator to the 0 (off) setting via the controls does not shut off electrical power to the refrigerator

Control settings will vary based on personal preferences, usage and operating conditions and may require more than one adjustment.

The temperature controls are preset in the factory at 37°F for the refrigerator compartment and 0°F for the freezer compartment. Allow 24 hours for the temperature to stabilize to the preset recommended settings.

The temperature controls can display both the SET temperature as well as the actual temperature in the refrigerator and freezer. The actual temperature may vary slightly from the SET temperature based on usage and operating environment.

Setting either or both controls to OFF stops cooling in both the freezer and refrigerator compartments, but does not shut off electrical power to the refrigerator.

NOTE: The refrigerator is shipped with protective film covering the temperature controls. If this film was not removed during installation, remove it now.

## **About the water filter cartridge. (On some models.)**

### **Water Filter Cartridge**

The water filter cartridge is located in the back upper right corner of the refrigerator compartment.

### **When to Replace the Filter on Models With a Replacement Indicator Light**

There is a replacement indicator light for the water filter cartridge on the dispenser. This light will turn orange to tell you that you need to replace the filter soon.

The filter cartridge should be replaced when the replacement indicator light turns red or if the flow of water to the dispenser or icemaker decreases.

### **When to Replace the Filter on Models Without a Replacement Indicator Light**

The filter cartridge should be replaced every six months or earlier if the flow of water to the water dispenser or icemaker decreases.

### **Removing the Filter Cartridge**

If you are replacing the cartridge, first remove the old one by slowly turning it to the left. Do not pull down on the cartridge. A small amount of water may drip down.

## Installing the Filter Cartridge

1. If you are replacing a SmartWater cartridge with an adapter, it must be removed before installing the cartridge. To remove the adapter, turn it to the left about 1/4 turn.

If you are replacing a Water by Culligan cartridge, leave the adapter in place. This adapter will stay in the refrigerator when you replace future cartridges.

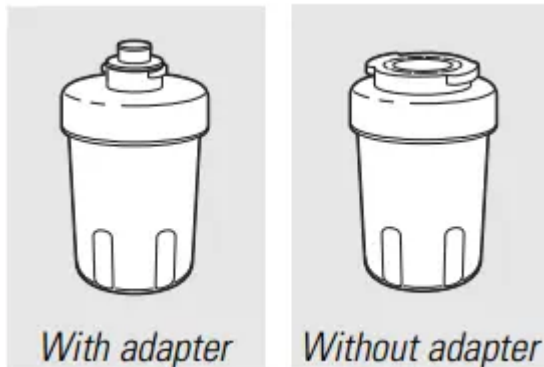

*(appearance may vary)*

2. On models without a replacement indicator light, apply the month and year sticker to the new cartridge to remind you to replace the filter in six months.

3. Fill the replacement cartridge with water from the tap to allow for better flow from the dispenser immediately after installation.

4. Line up the arrow on the cartridge and the cartridge holder. Place the top of the new cartridge up inside the holder. Do not push it up into the holder.

5. Slowly turn it to the right until the filter cartridge stops. DO NOT OVERTIGHTEN. As you turn the cartridge, it will automatically raise itself into position. The cartridge will move about 1/2 turn.

6. Run water from the dispenser for 1-1/2 gallons (about three minutes) to clear the system and prevent sputtering.

7. Press and hold the RESET WATER FILTER pad (on some models) on the dispenser for three seconds.

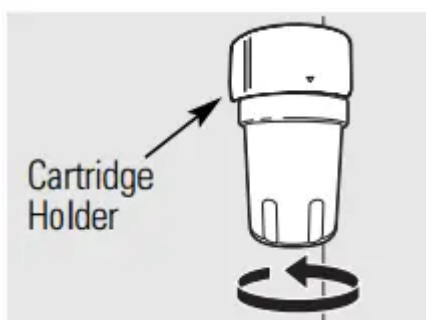

## Filter Bypass Plug

You must use the filter bypass plug when a replacement filter cartridge is not available. The dispenser and the icemaker will not operate without the filter or filter bypass plug

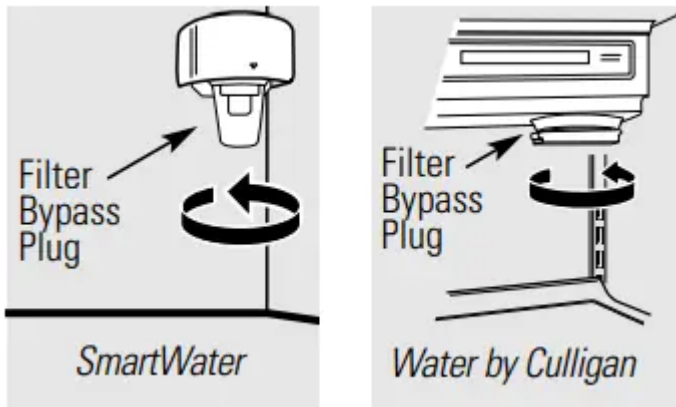

To use the filter bypass plug on Water by Culligan models, you must first remove the filter adapter from the cartridge holder by turning it to the left.

For the maximum benefit of your filtration system, GE recommends the use of GE branded SmartWater filters only. Using GE branded filters in GE and Hotpoint refrigerators provides optimal performance and reliability. GE branded SmartWater filters are always the right choice because they are patented and designed specifically for GE products. GE SmartWater filters meet rigorous industry NSF standards for safety and quality that are important for products that are filtering your water. GE has not qualified non-GE branded filters for use in GE and Hotpoint refrigerators and there is no assurance that non-GE branded filters meet GE's standards for quality, performance and reliability

### About the automatic icemaker

A newly-installed refrigerator may take 12–24 hours to begin making ice.

#### Automatic Icemaker (on some models)

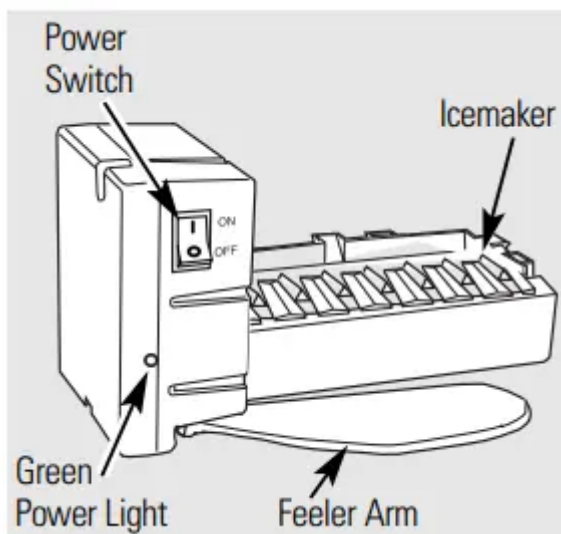

When the refrigerator has been connected to the water supply, slide the power switch to the ON position.

The icemaker will fill with water when it cools to 15°F. When the bin fills to the level of the feeler arm, the icemaker will stop producing ice.

Be sure nothing interferes with the sweep of the feeler arm.

Throw away the first few batches of ice to allow the water line to clear

The icemaker will produce seven cubes per cycle—approximately 100–130 cubes in a 24- hour period, depending on freezer compartment temperature, room temperature, number of door openings and other use conditions.

You will hear a buzzing sound each time the icemaker fills with water

It is normal for several cubes to be joined together. If ice is not used frequently, old ice cubes will become cloudy, taste stale, and shrink.

### Icemaker Accessory Kit

If your refrigerator did not come already equipped with an automatic icemaker, an icemaker accessory kit is available at extra cost. Check the back of the refrigerator for the specific icemaker kit needed for your model.

### About the ice and water dispenser. (On some models.)

#### To Use the Dispenser

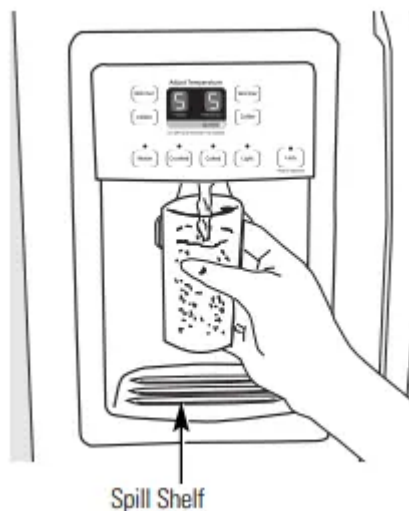

Select  Water  Crushed  OR  Cubed

Press the glass gently against the top of the dispenser cradle.

The spill shelf is not self-draining. To reduce water spotting, the shelf and its grille should be cleaned regularly.

## Locking the Dispenser (on some models)

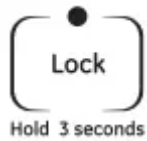

Press the Lock pad for 3 seconds to lock the dispenser and control panel. To unlock, press and hold the pad again for 3 seconds.

If no water is dispensed when the refrigerator is first installed, there may be air in the water line system. Press the dispenser arm for at least two minutes to remove trapped air from the water line and to fill the water system. To flush out impurities in the water line, throw away the first six glassfuls of water

**CAUTION:** Never put fingers or any other objects into the ice crusher discharge opening

## Dispenser Light



This pad turns the night light in the dispenser on and off. The light also comes on when the dispenser cradle is pressed. If this light burns out, it should be replaced with a 6 watt maximum, 12 volt DC bulb.

## Ice Storage Drawer on Dispenser Models

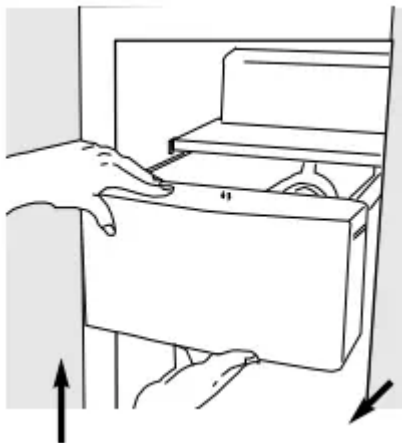

### To remove:

Slide the icemaker power switch to the OFF position. Pull the drawer straight out and then lift past the stop position.

### To replace:

When replacing the drawer, make sure to push it firmly into place. If it does not go all the way back, remove it and rotate the drive mechanism 1/4 turn. Then push the drawer back again.

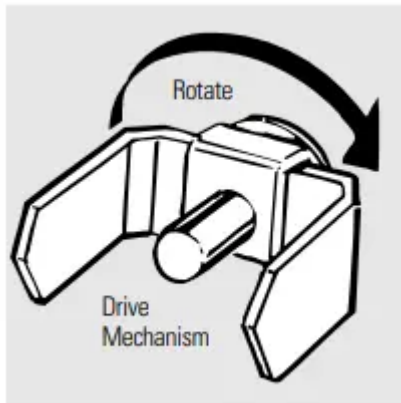

### Important Facts About Your Dispenser

- Do not add ice from trays or bags to the storage bin. It may not crush or dispense well.
- Avoid overfilling glass with ice and use of narrow glasses. Backed-up ice can jam the chute or cause the door in the chute to freeze shut. If ice is blocking the chute, poke it through with a wooden spoon.
- Beverages and foods should not be quick-chilled in the ice storage bin. Cans, bottles or food packages in the storage bin may cause the icemaker or auger to jam.
- To keep dispensed ice from missing the glass, put the glass close to, but not touching, the dispenser opening.
- Some crushed ice may be dispensed even though you selected Cubed. This happens occasionally when a few cubes have been left in the crusher.
- After crushed ice is dispensed, some water may drip from the chute.
- Sometimes a small mound of snow will form on the door in the ice chute. This condition is normal and usually occurs when you have dispensed crushed ice repeatedly. The snow will eventually evaporate.
- The first glass of water dispensed may be warmer than the following ones. This is normal.
- Dispensed water is not ice cold. For colder water, simply add crushed ice or cubes before dispensing water.

# Care and cleaning of the refrigerator

## Cleaning the Outside



The dispenser drip area, (on some models) beneath the grille, should be wiped dry. Water left in this area may leave deposits. Remove the deposits by adding undiluted vinegar to the well. Soak until the deposits disappear or become loose enough to rinse away.

The dispenser cradle (on some models). Before cleaning, lock the dispenser by pressing and holding the Lock pad for 3 seconds. Clean with warm water and baking soda solution—about a tablespoon (15 ml) of baking soda to a quart (1 l) of water. Rinse thoroughly and wipe dry

The door handles and trim. Clean with a cloth dampened with soapy water. Dry with a soft cloth.

Keep the outside clean. Wipe with a clean cloth lightly dampened with kitchen appliance wax or mild liquid dish detergent. Dry and polish with a clean, soft cloth.

The stainless steel door panels and handles.

The stainless steel panels can be cleaned with a commercially available stainless steel cleaner or a similar product using a clean, soft cloth. Do not use appliance wax, polish, bleach or products containing chlorine on stainless steel doors and handles.

For best results, GE recommends using stainless steel cleaner PM10X311 with the WX10X307 polishing cloth, or for convenience the SS cleaning wipes, part number WX10X10001.

Do not wipe the refrigerator with a soiled dish cloth or wet towel. These may leave a residue that can erode the paint. Do not use scouring pads, powdered cleaners, bleach or cleaners containing bleach because these products can scratch and weaken the paint finish.

## Cleaning the Inside

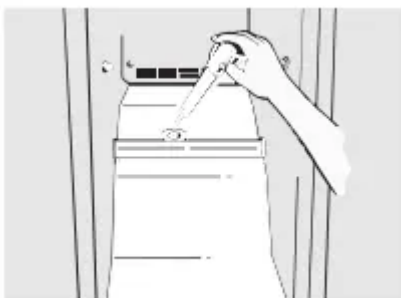

To help prevent odors, leave an open box of baking soda in the refrigerator and freezer compartments.

Unplug the refrigerator before cleaning. If this is not practical, wring excess moisture out of sponge or cloth when cleaning around switches, lights or controls.

Use warm water and baking soda solution—about a tablespoon (15 ml) of baking soda to a quart (1 l) of water. This both cleans and neutralizes odors. Rinse and wipe dry

After cleaning the door gaskets, apply a thin layer of petroleum jelly to the door gaskets at the hinge side. This helps keep the gaskets from sticking and bending out of shape.

Drain opening in freezer compartment. During yearly cleaning, remove bottom freezer pan and flush a solution of baking soda—1 teaspoon (5 ml) and 2 cups (500 ml) of hot (not boiling) water—through the drain line with the help of a meat baster. This will help eliminate odor and reduce the likelihood of a clogged drain line. If drain becomes clogged, use a meat baster and baking soda solution to force the clog through the drain line.

Avoid cleaning cold glass shelves with hot water because the extreme temperature difference may cause them to break. Handle glass shelves carefully. Bumping tempered glass can cause it to shatter. Do not wash any plastic refrigerator parts in the dishwasher.

## **Behind the Refrigerator**

Be careful when moving the refrigerator away from the wall. All types of floor coverings can be damaged, particularly cushioned coverings and those with embossed surfaces.

Pull the refrigerator straight out and return it to position by pushing it straight in. Moving the refrigerator in a side direction may result in damage to the floor covering or refrigerator.

When pushing the refrigerator back, make sure you don't roll over the power cord or icemaker supply line (on some models)

## **Preparing for Vacation**

For long vacations or absences, remove food and unplug the refrigerator. Clean the interior with a baking soda solution of one tablespoon (15 ml) of baking soda to one quart (1 l) of water. Leave the doors open.

Slide the icemaker power switch to the OFF position and shut off the water supply to the refrigerator.

## **Preparing to Move**

Secure all loose items such as grille, shelves and drawers by taping them securely in place to prevent damage.

Be sure the refrigerator stays in an upright position during moving.

## **Replacing the Light Bulbs**

**NOTE:** Turning the refrigerator to the 0 (off) setting via the controls does not shut off electrical power to the refrigerator.

1. Unplug the refrigerator.
2. Remove the shelf just below the light shield.
3. Replace with an appliance bulb of the same or lower wattage.
4. Reinstall the shelf and plug the refrigerator back in.

## Troubleshooting Tips

### Normal operating sounds

Newer refrigerators sound different from older refrigerators. Modern refrigerators have more features and use newer technology.

Do you hear what I hear? These sounds are normal.

**HUMMM...**  
**WHOOSH...**

- The new high efficiency compressor may run faster and longer than your old refrigerator and you may hear a high-pitched hum or pulsating sound while it is operating.
- Sometimes the refrigerator runs for an extended period, especially when the doors are opened frequently. This means that the Frost Guard™ feature is working to prevent freezer burn and improve food preservation.
- You may hear a whooshing sound when the doors close. This is due to pressure equalizing within the refrigerator

**WHIR!**  

- You may hear the fans spinning at high speeds. This happens when the refrigerator is first plugged in, when the doors are opened frequently or when a large amount of food is added to the refrigerator or freezer compartments. The fans are helping to maintain the correct temperatures.
- If either door is open for over 3 minutes, you may hear the fans come on in order to cool the light bulbs.
- The fans change speeds in order to provide optimal cooling and energy savings.

### CLICKS, POPS, CRACKS and CHIRPS

- You may hear cracking or popping sounds when the refrigerator is first plugged in. This happens as the refrigerator cools to the correct temperature.
- Electronic dampers click open and closed to provide optimal cooling and energy savings.
- The compressor may cause a clicking or chirping sound when attempting to restart (this could take up to 5 minutes).
- The electronic control board may cause a clicking sound when relays activate to control refrigerator components.
- Expansion and contraction of cooling coils during and after defrost can cause a cracking or popping sound.
- On models with an icemaker, after an icemaking cycle, you may hear the ice cubes dropping into the ice bucket.

## **WATER SOUNDS**



- The flow of refrigerant through the freezer cooling coils may make a gurgling noise like boiling water.
- Water dropping on the defrost heater can cause a sizzling, popping or buzzing sound during the defrost cycle.
- A water dripping noise may occur during the defrost cycle as ice melts from the evaporator and flows into the drain pan.
- Closing the door may cause a gurgling sound due to pressure equalization.

## Before you call for service...

Problem	Possible Causes	What To Do
Refrigerator does not operate	Refrigerator in defrost cycle.	• Wait about 30 minutes for defrost cycle to end.
	Freezer control in 0 (off) position.	• Move the freezer control to a temperature setting.
	Refrigerator is unplugged.	• Push the plug completely into the outlet.
	The fuse is blown/circuit breaker is tripped.	• Replace fuse or reset the breaker.
Refrigerator or freezer compartment too warm	Temperature control not set cold enough.	• See About the controls.
	Warm weather or frequent door openings.	• Set the temperature control one step colder. See About the controls.
	Door left open.	• Check to see if package is holding door open.



Vibration or rattling	Front rollers need adjusting.	<ul style="list-style-type: none"> <li>• See Rollers. Slight vibration is normal.</li> </ul>
Motor operates for long periods or cycles on and off frequently. (Modern refrigerators with more storage space and a larger freezer require more operating time. They start and stop often to maintain even temperatures.)	Normal when refrigerator is first plugged in.	<ul style="list-style-type: none"> <li>• Wait 24 hours for the refrigerator to complete down.</li> </ul>
	Often occurs when large amounts of food are placed in refrigerator.	<ul style="list-style-type: none"> <li>• This is normal.</li> </ul>
	Door left open.	<ul style="list-style-type: none"> <li>• Check to see if package is holding door open.</li> </ul>
	Hot weather or frequent door openings.	<ul style="list-style-type: none"> <li>• This is normal.</li> </ul>
	Temperature controls set at the coldest setting.	<ul style="list-style-type: none"> <li>• See About the controls.</li> </ul>
Frost or ice crystals on frozen food (frost within package is normal)	Door left open.	<ul style="list-style-type: none"> <li>• Check to see if package is holding door open.</li> </ul>
	Too frequent or too long door openings.	
Divider between refrigerator and freezer compartments feels warm	Automatic energy saver system circulates warm liquid around front edge of freezer compartment.	<ul style="list-style-type: none"> <li>• This helps prevent condensation on the outside.</li> </ul>
Automatic icemaker does not work (on some models)	Icemaker power switch is in the O (off) position.	<ul style="list-style-type: none"> <li>• Set the power switch to the I (on) position.</li> </ul>
	Water supply turned off or not connected.	<ul style="list-style-type: none"> <li>• See Installing the water line.</li> </ul>
	Freezer compartment too warm.	<ul style="list-style-type: none"> <li>• Wait 24 hours for the refrigerator to complete down.</li> </ul>
	Piled up cubes in the storage bin cause icemaker to shut off.	<ul style="list-style-type: none"> <li>• Level cubes by hand.</li> </ul>
	Ice cubes stuck in icemaker. (Green power light on icemaker blinking.)	<ul style="list-style-type: none"> <li>• Turn off the icemaker, remove cubes, and turn icemaker back on.</li> </ul>



Ice cubes have odor/ taste	Ice storage bin needs cleaning.	• Empty and wash bin. Discard old cubes.
	Food transmitting odor/taste to ice cubes.	• Wrap foods well.
	Interior of refrigerator needs cleaning.	• See Care and cleaning.
Small or hollow cubes	Water filter clogged.	• Replace filter cartridge with new cartridge or plug.
Slow ice cube freezing	Door left open.	• Check to see if package is holding door open.
	Temperature control not set cold enough.	• See About the controls.
Door not closing properly	Door gasket on hinge side sticking or folding over.	• Apply petroleum jelly on face of gasket.
Orange glow in freezer	Defrost heater is on.	• This is normal.
Cube dispenser does not work (on some models)	Icemaker or water supply turned off.	• Turn on icemaker or water supply.
	Ice cubes are frozen to icemaker feeler arm.	• Remove cubes.
	Irregular ice clumps in storage container.	• Break up with fingertip pressure and discard remaining clumps.
		• Freezer may be too warm. Adjust the freezer to a colder setting, one position at a time, until clumps do not form.
Dispenser is LOCKED.	• Press and hold the LOCK CONTROL pad for 3 seconds.	



Water has poor taste/odor (on some models)	Water dispenser has not been used for a long time.	<ul style="list-style-type: none"> <li>• Dispense water until all water in system is replenished.</li> </ul>
Water in first glass is warm (on some models)	Normal when refrigerator is first installed.	<ul style="list-style-type: none"> <li>• Wait 24 hours for the refrigerator to complete down.</li> </ul>
	Water dispenser has not been used for a long time.	<ul style="list-style-type: none"> <li>• Dispense water until all water in system is replenished.</li> </ul>
	Water system has been drained.	<ul style="list-style-type: none"> <li>• Allow several hours for replenished supply</li> </ul>
Water dispenser does not work (on some models)	Water supply line turned off or not connected.	<ul style="list-style-type: none"> <li>• See Installing the water line.</li> </ul>
	Water filter clogged.	<ul style="list-style-type: none"> <li>• Replace filter cartridge or remove filter and plug.</li> </ul>
	Air may be trapped in the water system.	<ul style="list-style-type: none"> <li>• Press the dispenser arm for at least two m</li> </ul>
	Dispenser is LOCKED.	<ul style="list-style-type: none"> <li>• Press and hold the LOCK CONTROL pad seconds.</li> </ul>
Water spurting from dispenser	Newly-installed filter cartridge.	<ul style="list-style-type: none"> <li>• Run water from the dispenser for 3 minutes (1/2 gallons).</li> </ul>
Water is not dispensed	Water in reservoir is frozen.	<ul style="list-style-type: none"> <li>• Call for service.</li> </ul>
No water or ice cube production	Supply line or shutoff valve is clogged.	<ul style="list-style-type: none"> <li>• Call a plumber.</li> </ul>
	Water filter clogged.	<ul style="list-style-type: none"> <li>• Replace filter cartridge or remove filter and plug.</li> </ul>
	Dispenser is LOCKED.	<ul style="list-style-type: none"> <li>• Press and hold the LOCK CONTROL pad seconds.</li> </ul>
Refrigerator has odor	Foods transmitting odor to refrigerator.	<ul style="list-style-type: none"> <li>• Foods with strong odors should be tightly v</li> <li>• Keep an open box of baking soda in the re</li> <li>• replace every three months.</li> </ul>
	Interior needs cleaning.	<ul style="list-style-type: none"> <li>• See Care and cleaning.</li> </ul>



	Defrost water drainage system needs cleaning.	<ul style="list-style-type: none"> <li>• See Care and cleaning.</li> </ul>
Moisture forms on outside of refrigerator	Not unusual during periods of high humidity.	<ul style="list-style-type: none"> <li>• Wipe surface dry.</li> </ul>
Moisture collects inside	Too frequent or too long door openings.	
Interior light does not work	No power at outlet.	<ul style="list-style-type: none"> <li>• Replace fuse or reset the breaker.</li> </ul>
	Light bulb burned out.	<ul style="list-style-type: none"> <li>• See Replacing the light bulbs.</li> </ul>
Water on kitchen floor or on bottom of freezer	Drain in the bottom of the freezer clogged.	<ul style="list-style-type: none"> <li>• See Care and cleaning.</li> </ul>
	Cubes jammed in chute.	<ul style="list-style-type: none"> <li>• Poke ice through with a wooden spoon.</li> </ul>
Hot air from bottom of refrigerator	<p>Normal air flow cooling motor.</p> <p>In the refrigeration process, it is normal that heat be expelled in the area under the refrigerator. Some floor coverings are sensitive and will discolor at these normal air temperatures.</p>	
CUBED ICE was selected but CRUSHED ICE was dispensed (on some models)	Last setting was CRUSHED ICE.	<ul style="list-style-type: none"> <li>• A few cubes were left in the crusher from the previous setting. This is normal.</li> </ul>
Frequent "buzzing" sound	Icemaker power switch is in the I (on) position but the water supply to the refrigerator has not been connected.	<ul style="list-style-type: none"> <li>• Set the power switch to the O (off) position. If it is in the I (on) position will damage the water filter.</li> </ul>

### Warning

This content is compiled from multiple sources and is provided for reference purposes only. It may not be complete or fully applicable to all situations. If you are unable to resolve your issue, please contact the product manufacturer or an authorized service provider for official support.

