

Getting to know your appliance

In this chapter, we will explain the indicators and controls. You will also find out about the various functions of your appliance.

Note: Depending on the appliance model, individual details and colours may differ.

Control panel

In the control panel, you can use the various buttons, touch fields and the rotary selector to set the different appliance functions. The current settings are shown on the display.

The overview shows the control panel when the appliance is switched on with a selected heating type.

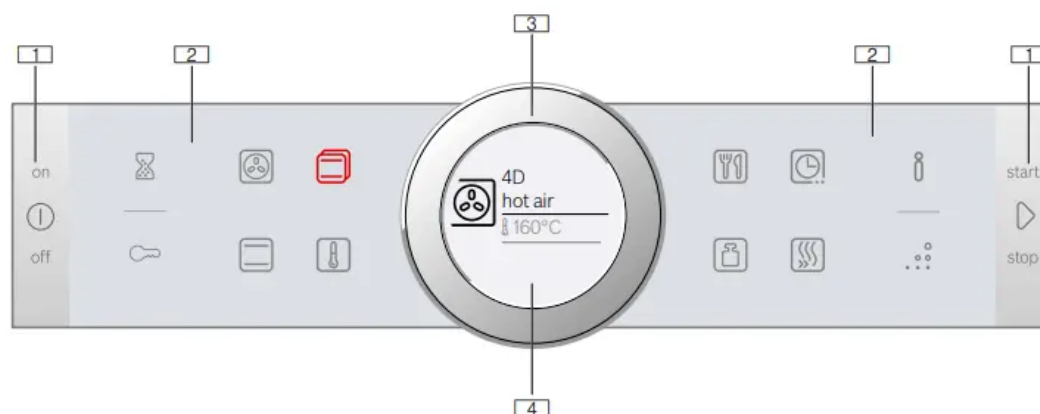

1. Buttons

The buttons on the left- and right-hand side of the control panel have a pressure point. Press these buttons to activate them.

For appliances that do not have a stainless steel front, these two button touch fields do not have a pressure point.

2. Touch fields

There are sensors under the touch fields. Simply touch the respective symbol to select the function.

3. Rotary selector

The rotary selector is fitted so that you can turn it indefinitely to the left or right. Press it lightly and move it in the direction required using your finger.

4. Display















You can see the current adjustment values, options or notes in the display.

Controls

The individual controls are adapted for the various functions of your appliance. You can set your appliance simply and directly.

Buttons and touch fields

Here you can find a short explanation of the various buttons and touch fields.

Symbol		Meaning
Buttons		
	on/off	Switching the appliance on and off
	Start/Stop	Starting, pausing or cancelling (hold down for approx. 3 secs) an operation
External touch fields		
	Timer	Selects the timer
	Childproof lock	Activating and deactivating (hold down for approx. 4 secs) the childproof lock
	Information	Display notes Hold down (approx. 3 secs) to call up the basic settings
	EcoClean	Selects the "cleaning function" operating mode
Internal touch fields		
	4D hot air	Selects the "4D hot air" heating type directly
	Top/bottom heating	Selects the "Top/bottom heating" heating type directly
	Heating types	Selects the "heating types" operating mode
	Temperature	Selects the temperature in the cooking compartment
	AutoCook	Selects the operating mode for dishes with cooking programmes
	Weight	Selects the weight for the operating mode for dishes
	Time-setting options	Select time-setting options
	Rapid heating	Starts or cancels Rapid heating for the cooking compartment

The touch field, which has a value on the display that can be changed or displayed in the foreground, lights up red.

Rotary selector

You can use the rotary selector to change the adjustment values shown on the display.

In most selection lists, such as the temperature, you have to turn the rotary selector back the other way if you reach the minimum or maximum value. However, for the heating types for example, the first selection follows the last.

Display

The display is structured so that the information can be read at a glance in any situation.

The value that you can currently set is in focus. It is displayed in white lettering and underlined in white. The value in the background is displayed in grey

Focus	<p>The value in focus can be changed directly without first being selected.</p> <p>After starting an operation, either the temperature or the level is always in focus. At the same time, the white line is the heating line and gradually turns red.</p>
Enlargement	<p>As you change the value in focus using the rotary selector, only this value is displayed larger.</p>



Display ring

The display ring can be found around the outside of the display.

If you change a value, the display ring shows you where you are in the selection list. Depending on the settings area and length of the selection list, the display ring may be continuous or divided into segments.

During operation, the display ring turns red at second-long intervals. After every full minute, the segments turn red again from the beginning. As the cooking time counts down, one segment disappears every second.

Temperature display

After the operation has started, the current cooking compartment temperature is displayed graphically on the display

Heating line	<p>The white line under the temperature turns red from left to right as the cooking compartment heats up. When you are preheating the appliance, the optimal time to place the food in the cooking compartment is when the line has completely turned red.</p> <p>For set levels, e.g. the grill setting, the heating line turns red immediately.</p>
Residual heat indicator	<p>When the appliance is switched off, the display ring shows the residual heat in the cooking compartment. As the residual heat cools down, the display ring becomes darker and disappears completely at some point.</p>

Note: Due to thermal inertia, the temperature displayed may be slightly different to the actual temperature inside the oven.

Operating modes

Your appliance has various operating modes which make your appliance easier to use.

You can find more precise descriptions of these in the corresponding sections.













Operating mode	Use
Heating types → <i>"Operating the appliance" on page 14</i>	There are various finely tuned heating types for the optimal preparation of your food.
AutoCook → <i>"Dishes" on page 28</i>	There are preprogrammed setting values which are suitable for many dishes
EcoClean → <i>"Cleaning function" on page 22</i>	The cleaning function cleans the cooking compartment almost by itself.

Types of heating

To enable you to find the correct type of heating for your dish, we have explained the differences and scopes of application here.

The symbols for each type of heating help you to remember them.

When cooking at very high temperatures, the appliance lowers the temperature slightly after an extended period.

Heating type	Temperature	Use
 4D hot air	30-275 °C	For baking and roasting on one or more levels. The fan distributes heat from the ring heating element in the back panel evenly around the cooking compartment.
 Top/bottom heating	30-300 °C	For traditional baking and roasting on one level. Especially suitable for cakes with moist toppings. Heat is emitted evenly from the top and bottom.
 Hot air eco	30-275 °C	For gently cooking selected types of food on one level without preheating. The fan distributes the heat from the ring-shaped heating element in the back panel around the cooking compartment. This heating function is most effective between 125 and 275 °C. This heating function is used to measure both the energy consumption in air recirculation mode and the energy efficiency class.
 Top/bottom heating eco	30-300 °C	For gently cooking selected types of food. Heat is emitted from above and below. This heating function is most effective between 150 and 250 °C. This heating function is used to measure the energy consumption in the conventional mode.
 Hot air grilling	30-300 °C	For roasting poultry, whole fish and larger pieces of meat. The grill element and the fan switch on and off alternately. The fan circulates the hot air around the food.
 Grill, large area	Grill settings: 1 = low 2 = medium 3 = high	For grilling flat items for grilling, such as steaks and sausages, for making toast, and for cooking au gratin. The whole area below the grill element becomes hot.
 Grill, small area	Grill settings: 1 = low 2 = medium 3 = high	For grilling small amounts of steaks or sausages, for making toast, and for cooking au gratin. The centre area under the grill heating element becomes hot.
 Pizza setting	30-275 °C	For preparing pizza and dishes which require a lot of heat from underneath. The bottom heating element and the ring heating element in the back panel heat up.
 Slow cooking	70-120 °C	For gentle and slow cooking of seared, tender pieces of meat in ovenware without a lid. The heat is emitted evenly from the top and bottom at low temperatures.
 Bottom heating	30-250 °C	For cooking in a bain marie and for the final baking stage. The heat is emitted from below.
 Defrosting	30-60 °C	For gently defrosting frozen food.
 Keeping warm	60-100 °C	For keeping cooked food warm.
 Preheating ovenware	30-70 °C	For preheating ovenware.

Default values

For each heating type, the appliance specifies a default temperature or level. You can accept this value or change it in the appropriate area.

Further information

In most cases, the appliance provides notes and further information on the action just carried out.

Touch the  field. The note is shown in the display for a few seconds. Use the rotary selector to scroll to the end of longer notes.

Some notes are displayed automatically, for example as confirmation, or to provide an instruction or warning.

Cooking compartment functions

The functions in the cooking compartment make your appliance easier to use. This, for example, enables the cooking compartment to be well lit and a cooling fan to prevent the appliance from overheating.

Opening the appliance door

If you open the appliance door during an on-going operation, the operation is paused. The operation continues to run when you close the door.

Interior lighting

When you open the appliance door, the interior lighting switches on. If the door remains open for longer than around 15 minutes, the lighting switches off again.

For most operating modes, the interior lighting switches on as soon as the operation is started. When the operation has finished, the lighting switches off.

Note: You can set the interior lighting not to come on during the operation in the basic settings. → "*Basic settings*" on page 19

Cooling fan

The cooling fan switches on and off as required. The hot air escapes above the door.

Caution!

Do not cover the ventilation slots. Otherwise, the appliance may overheat.

So that the cooking compartment cools down more quickly after the operation, the cooling fan continues to run for a certain period afterwards.

Note: You can change how long the cooling fan continues to run in the basic settings. → "*Basic settings*" on page 19

Before using for the first time

Before you can use your new appliance, you must make some settings. You must also clean the cooking compartment and accessories.

Initial use

After connecting the appliance to the power or following a power cut, the settings for initial use are shown on the display. It may take a few seconds for the instruction to appear.

Note: You can change these settings at any time in the basic settings. → "*Basic settings*" on page 19

Setting the language

The language is the first setting displayed. "German" is the preset language.

1. Turn the rotary selector to set the required language.
2. Press the  field to confirm.

The next setting appears.

Setting the time

The time starts at "12:00".

1. Set the time using the rotary selector
2. Press the  field to confirm.

A note appears on the display confirming that the initial use has been completed. The current time is displayed.

Cleaning the cooking compartment and accessories

Before using the appliance to prepare food for the first time, you must clean the cooking compartment and accessories.

Cleaning the cooking compartment

To remove the new-appliance smell, heat up the cooking compartment when empty and with the oven door closed.

Make sure that there is no leftover packaging, such as polystyrene pellets, in the cooking compartment and remove the adhesive tape that is in or on the appliance. Before heating up the appliance, wipe the smooth surfaces in the cooking compartment with a soft, wet cloth. Keep the kitchen ventilated while the appliance is heating up.

Adjust the settings indicated. You can find out how to set the heating type and the temperature in the next section. → "Operating the appliance" on page 14

Settings	
Heating type	4D hot air 
Temperature	maximum
Cooking time	1 hour

Switch off the appliance after the indicated cooking time using the  On/Off button.

After the cooking compartment has cooled down, clean the smooth surfaces with soapy water and a dish cloth.

Cleaning the accessories

Clean the accessories thoroughly using soapy water and a dish cloth or soft brush.

Operating the appliance

You have already learnt about the controls and how they work. Now we will explain how to set your appliance. You will learn about what happens when you switch the appliance on and off, and how to select the operating mode.

Switching the appliance on and off

Before you are able to set the appliance, you must switch it on.

Note: The childproof lock and the timer can also be set when the appliance is switched off. Certain displays and notes, such as those relating to the residual heat in the cooking compartment, remain visible on the display after the appliance has been switched off.

Switch off your appliance when you do not need to use it. If no settings are applied for a long time, the appliance switches itself off automatically.

Switching on the appliance

Press the  On/Off button to switch on the appliance.

All touch fields light up red. The Bosch logo appears on the display, and then the first heating type in the selection list.

Note: In the basic settings, you can specify which operating mode should appear after the appliance is switched on. → *"Basic settings" on page 1*

Switching off the appliance

Press the  On/Off button to switch off the appliance.

Any functions that may be running are cancelled.

The time, or if applicable, the residual heat indicator, appears on the display.

Note: In the basic settings, you can set whether the clock should be displayed when the appliance is switched off. → *"Basic settings" on page 19*

Starting the operation

You must press the  Start/Stop button to start each operation.

After starting the appliance, the time display is shown on the display along with the settings. The display ring and the heating line also appear.

Pausing the operation

You can also interrupt and then continue an operation using the  Start/Stop button.

If you press and hold the  Start/Stop button for approx. 3 seconds, the operation is cancelled and all settings are reset.

Note: The fan may continue to run after an operation has been paused or cancelled.

Selecting an operating mode

Once the appliance is switched on, the default operating mode is displayed. You can start this setting immediately using the  Start/Stop button.

If you want to select a different operating mode, you can find detailed descriptions of these modes in the relevant chapters.

The following always applies:

1. Touch the appropriate field.

The symbol lights up red

2. Turn the rotary selector to change the highlighted selection.

3. If necessary, apply other settings.

To do this, touch the appropriate text field and change the value using the rotary selector.

4. Press the  Start/Stop button to start.

The appliance starts the operation.

Setting the type of heating and temperature

If the "Types of heating" operating mode has not been selected, touch the  field. The symbol lights up red and the first type of heating with the default temperature appears on the display.

Example in the picture: Hot air eco  at 195 °C.

1. Set the type of heating using the rotary selector.

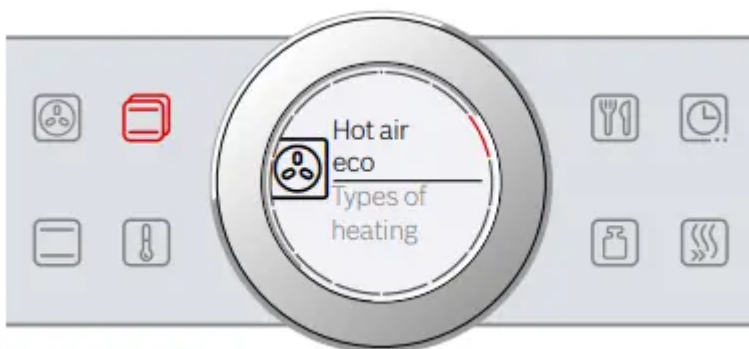

2. Touch the  field.

The temperature is highlighted white in the display.

3. Set the temperature using the rotary selector.

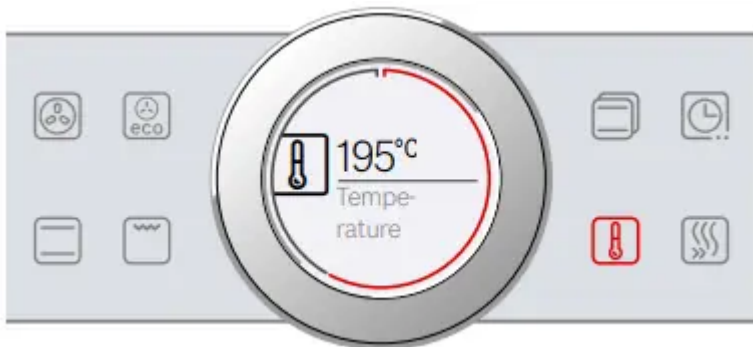

4. Press the  Start/Stop button to start.

The time on the display shows how long the operation has already been running.





The appliance begins to heat up.

When your dish is ready, switch off the appliance using the  On/Off button.

Note: You can set a cooking time and an end time for the operation on the appliance. →
"Time-setting options" on page 16

Changing

After starting the appliance, the temperature is highlighted. When you move the rotary selector, the temperature is changed and applied immediately.



To change the type of heating, first press the  Start/Stop button to interrupt the operation and then touch the  field. The first type of heating appears with the corresponding default temperature. Use the rotary selector to change the type of heating.

Note: When you change the type of heating, the other settings are also reset.

Directly selecting types of heating

You can select certain types of heating directly using the touch fields. This makes the appliance even easier and faster to set.

The types of heating that can be set directly are:

-  4D hot air
-  Top/bottom heating

Applying settings

1. Touch the field with the required type of heating.

The temperature is immediately highlighted white.

2. Set the temperature using the rotary selector.



3. Press the  Start/Stop button to start.

The appliance begins to heat up.

Rapid heating

With Rapid heating, you can shorten the heat-up time for some heating types.

The heating types suitable for Rapid heating are:

-  4D hot air
-  Top/bottom heating

To achieve an even cooking result, do not place your food or accessories into the cooking compartment until "Rapid heating" is complete.

Adjusting settings

Ensure you have selected a suitable heating type and set a temperature of at least 100 °C. Otherwise, Rapid heating cannot be activated.

1. Set the heating type and temperature.
2. Touch the  field.

The symbol lights up red. A confirmation note appears on the display.

When Rapid heating comes to an end, an audible signal sounds and a note appears on the display. The symbol is no longer lit up. Place your dish in the cooking compartment.



Note: The "Cooking time" time-setting option starts at the same time as Rapid heating. Therefore, only set a cooking time when Rapid heating has come to an end.



Cancelling

To cancel Rapid heating, touch the  field again. The symbol is no longer lit up.

Time-setting options

Your appliance has different time-setting options.

Time-setting option	Use
 Cooking time	After the set cooking time has elapsed, the appliance ends the operation automatically.
 End	Enter a cooking time and the required end time. The appliance starts automatically so that the operation ends at the required time.
 Timer	The timer functions like an egg timer. It runs independently of the operation and the other time-setting options. After the set time has elapsed, the appliance does not switch on or off automatically.

You can call up the cooking time and the end time after setting an operation using the  field. The timer has a separate  field and can be adjusted at any time.

A signal sounds after a cooking time or timed period has elapsed. You can cancel the signal early by touching the  field.

Note: You can change how long the signal sounds for in the basic settings. → "Basic settings" on page 19

Setting the cooking time

You can set the cooking time for your dish on the appliance. This means that the cooking time is not unintentionally exceeded and you do not need to interrupt other work in order to end the operation.

Applying settings

Depending on which direction you turn the rotary selector first, the cooking time starts at a particular default value: Left = 10 minutes, right = 30 minutes.

The cooking time can be set in one-minute increments up to one hour, and then in five-minute increments.

The maximum setting is 23 hours and 59 minutes.

Example in the picture: Cooking time of 45 minutes

1. Set the operating mode, and temperature or level.
2. Touch the  field before starting

The cooking time is highlighted white in the display.

3. Turn the rotary selector to set the cooking time.

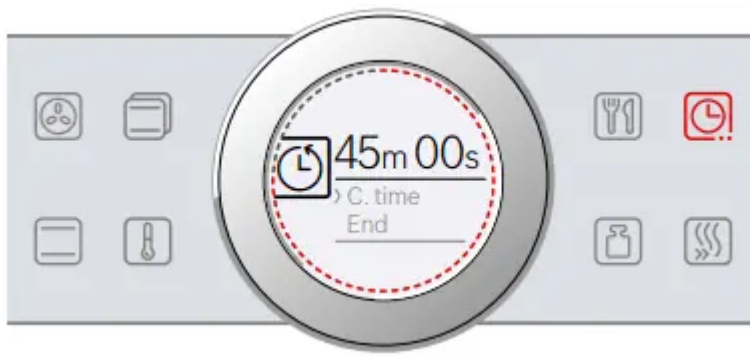

The value is applied after a few seconds, or touch the  field twice. The cooking time is shown on the display under the operating mode and temperature or level.



4. Press the  Start/Stop button to start.

The cooking time counts down on the display.





The appliance begins to heat up.

Once the cooking time has elapsed, an audible signal sounds. The appliance stops heating. The cooking time 00 m 00 s is shown on the display.

You can set another cooking time using the  field, or continue the operation without a cooking time using the  Start/Stop button.

When your dish is ready, switch the appliance off using the  On/Off button.

Changing and cancelling

To change the cooking time, touch the  field. The cooking time is highlighted white and can be changed using the rotary selector. Use the  field to accept the change.

If you want to cancel the cooking time, reset the cooking time to zero. After the change has been applied, you can continue the operation without a cooking time using the  Start/Stop button.

Setting the end time

You can delay the time that the cooking time ends. You can, for example, put your dish in the cooking compartment in the morning and set the cooking time so that it is ready at lunch time.

Notes

- Ensure that food is not left in the cooking compartment for too long as it may spoil.
- Do not adjust the end time once the operation has started. The cooking result would no longer be satisfactory.

Applying settings

The end of the cooking time can be delayed by a maximum of 23 hours and 59 minutes.

Example in the picture: It is 10:00, the set cooking time is 45 minutes and the dish should be ready at 12:00.

1. Set the operating mode, and temperature or level.
2. Set the cooking time.
3. Before starting the operation, touch the  field again once.

The end time is highlighted white in the display.

4. Set a later end time using the rotary selector.



The value is applied after a few seconds, or touch the  field again. The end time is shown in the display under the operating mode and temperature or level.



5. Press the  Start/Stop button to start.

The time at which the appliance will start is shown in the display





The appliance is in standby mode. When the appliance starts, the cooking time counts down on the display.

Once the cooking time has elapsed, an audible signal sounds. The appliance stops heating. The cooking time 00 m 00 s is shown on the display.

You can set another cooking time using the  field, or continue the operation without a cooking time using the  Start/Stop button.

When your dish is ready, switch the appliance off using the  On/Off button.

Changing and cancelling

To change the end time, interrupt the operation using the  Start/Stop button and then touch the  field twice. The end time is highlighted white and can be changed using the rotary selector. Continue the operation using the  Start/Stop button.

If you want to cancel the end time, reset the end time to zero. You can start the set cooking time immediately using the  Start/Stop button.

Note: The end time can only be changed if the cooking time has not elapsed. Otherwise the cooking result would no longer be satisfactory.

Setting the timer

The timer runs alongside other settings. You can set it at any time, even if the appliance is switched off. It has its own audible signal so that you can tell whether it is the timer or a cooking time which has elapsed.

Adjusting settings

The timer duration always starts at zero minutes.

The higher the value, the greater the time steps when setting the timer.

The maximum setting is 24 hours.

1. Touch the  field.

The symbol lights up red. On the display, the timer duration is shown in white and in focus.

2. Set the timer duration using the rotary selector.

3. Press the  field to start.

Note: After a few seconds, the timer also starts automatically.

The timer duration counts down.

The timer remains visible on the display if the appliance is switched off. When an operation is running, the settings for this operation are shown in the foreground. When you touch the  field, the timer duration is displayed for a few seconds.

When the timer duration comes to an end, an audible signal sounds and a note appears on the display. The symbol is no longer lit up.

Tip: If the set timer duration relates to the appliance operation, use the cooking time. The time is visible in the foreground and the appliance switches off automatically.

Changing and cancelling

To change the timer duration, touch the  field. The timer duration is displayed in white and in focus, and can be changed by using the rotary selector.

If you want to cancel the timer, reset the timer duration to zero. Once the change has been applied, the symbol is no longer lit up.

Childproof lock

Your appliance is equipped with a childproof lock so that children cannot switch it on accidentally or change any settings.



The control panel is locked and no settings can be made. The appliance can only be switched off using the  On/Off button.

Activating and deactivating

You can activate and deactivate the childproof lock when the appliance is switched on or off.

In each case, press the  field for approx. 4 seconds.

A confirmation note appears on the display.

The  field lights up red when the appliance is switched on. The  field does not light up when the appliance is switched off.

Basic settings

There are various settings available to you in order to help use your appliance effectively and simply. You can change these settings as required.

Changing the basic settings

The appliance must be switched off.

1. Touch the  field for approx. 3 seconds.

Notes on the process appear on the display.

2. Press the  field to confirm the notes.

The first setting "language" appears on the display.

3. Turn the rotary selector to change the setting as required.

4. Touch the  field.

The next setting is shown on the display and can be changed using the rotary selector.

5. Touch the  field to go through all the settings and use the rotary selector to make changes as required.

6. When finished, press and hold the  field for approx.

3 seconds to confirm the settings.

A note is shown on the display to confirm that the settings have been saved.

labelling

If you do not want to save the settings, you can press the  On/Off button to cancel. A note is shown on the display to confirm that the settings have not been saved.

List of basic settings

Depending on the features of your appliance, not all basic settings are accessible.

Setting	Options
Language	Additional languages are possible
Clock	Clock in 24-hour format
Audible signal	Short cooking time (30 sec.) Medium cooking time (1 min.)* Long cooking time (5 min.)
Button tone	Switched on Switched off* (tone remains for  On/ Off)
Display brightness	5 levels
Clock display	Off Digital*
Lighting	Off during operation On during operation*
Childproof lock	Button lock only* Door lock and button lock
Operation after switching on	Types of heating* AutoCook
Night-time darkening	Switched off* Switched on
Brand logo	Display* Do not display
Fan run-on time	Recommended* Minimum

Pull-out system	Not retrofitted* (for rails and single pull-out system) Retrofitted (for double and triple pull-out systems)
Sabbath mode	Switched on Switched off*
Factory settings	Restore Do not restore*

*** Factory setting (factory settings may vary depending on the appliance model)**

Note: Changes to the language, button tone and display brightness settings take effect immediately. All other changes take effect after the settings have been changed.

Power cut

The changes you make to the settings are saved even after a power cut.

You only have to reset the settings for the initial use following a long-term power cut. The appliance can bridge a short-term power cut.

Changing the time

If you want to change the time, for example from summer to winter time, you have to change the basic setting.

The appliance must be switched on.

1. Touch the  field for approx. 3 seconds.

Notes on the process appear on the display.

2. Press the  field to confirm the notes.

The first setting "language" appears in the display.

3. Touch the  field.

The setting for the clock appears.

4. Turn the rotary selector to change the clock time.

5. Press and hold the  field for approx. 3 seconds to confirm the setting.

A note is shown on the display to confirm that the settings have been saved.

Sabbath mode



With the Sabbath mode, a cooking time of up to 74 hours can be set. You can keep the food in the cooking compartment warm without having to switch the oven on or off.

Starting Sabbath mode

Before you are able to use the Sabbath mode, you must activate it in the basic settings. → *"Basic settings" on page 19*

When the basic setting has been changed accordingly, Sabbath mode is listed with the types of heating as the last type of heating.

The appliance heats up with top/bottom heating. You can set a temperature between 85 °C and 140 °C.

1. Set the  Sabbath mode type of heating using the rotary selector.
2. Touch the  field.

The temperature is highlighted white in the display.

3. Set the required temperature using the rotary selector.
4. Touch the  field before starting.

The cooking time is highlighted white in the display.

5. Set the required cooking time using the rotary selector.

Note: The end time cannot be delayed.

6. Press the  Start/Stop button to start.

The cooking time counts down on the display.

The appliance begins to heat up.



When the cooking time for Sabbath mode has ended, an audible signal sounds. The appliance stops heating. The cooking time 00 m 00 s is shown on the display.

Press the  On/Off button to switch off the appliance.

Note: The operation is not interrupted if you open the appliance door.

Changing and cancelling

After starting the appliance, the settings can no longer be changed.

If you would like to cancel Sabbath mode, switch the appliance off using the  On/Off button. You can no longer pause the operation using the  Start/Stop button.

Cleaning

With good care and cleaning, your appliance will retain its appearance and remain fully functioning for a long time to come. We will explain here how you should correctly care for and clean your appliance.

Suitable cleaning agents

To ensure that the different surfaces are not damaged by using the wrong cleaning agent, observe the information in the table. Depending on the appliance model, not all of the areas listed may be on/in your appliance.

Caution! Risk of surface damage

Do not use:

- Harsh or abrasive cleaning agents,
- Cleaning agents with a high alcohol content,
- Hard scouring pads or cleaning sponges,
- High-pressure cleaners or steam cleaners,
- Special cleaners for cleaning the appliance while it is hot.

Wash new sponge cloths thoroughly before use.

Tip: Highly recommended cleaning and care products can be purchased through the after-sales service. Observe the respective manufacturer's instructions.

Warning – Risk of burns!

The appliance becomes very hot. Never touch the interior surfaces of the cooking compartment or the heating elements. Always allow the appliance to cool down. Keep children at a safe distance.

Area	Cleaning
Appliance exterior	
Stainless steel front	<p>Hot soapy water:</p> <p>Clean with a dish cloth and then dry with a soft cloth.</p> <p>Remove flecks of limescale, grease, starch and albumin (e.g. egg white) immediately. Corrosion can form under such flecks.</p> <p>Special stainless steel cleaning products suitable for hot surfaces are available from our after-sales service or from specialist retailers. Apply a very thin layer of the cleaning product with a soft cloth</p>
Plastic	<p>Hot soapy water:</p> <p>Clean with a dish cloth and then dry with a soft cloth.</p> <p>Do not use glass cleaner or a glass scraper</p>
Painted surfaces	<p>Hot soapy water:</p> <p>Clean with a dish cloth and then dry with a soft cloth.</p>
Control panel	<p>Hot soapy water:</p> <p>Clean with a dish cloth and then dry with a soft cloth.</p> <p>Do not use glass cleaner or a glass scraper.</p>
Door panels	<p>Hot soapy water:</p> <p>Clean with a dish cloth and then dry with a soft cloth.</p> <p>Do not use a glass scraper or a stainless steel scouring pad.</p>
Door handle	<p>Hot soapy water:</p> <p>Clean with a dish cloth and then dry with a soft cloth.</p> <p>If descaler comes into contact with the door handle, wipe it off immediately. Otherwise, any stains will not be able to be removed.</p>
Appliance interior	

<p>Enamelled surfaces</p>	<p>Hot soapy water or a vinegar solution:</p> <p>Clean with a dish cloth and then dry with a soft cloth.</p> <p>Soften baked-on food remnants with a damp cloth and soapy water. Use stainless steel wire wool or oven cleaner to remove stubborn dirt.</p> <p>Caution!</p> <p>Never use oven cleaner in the cooking compartment when it is still warm. This may damage the enamel. Remove all food remnants from the cooking compartment and the appliance door before you next heat up the appliance.</p> <p>Leave the cooking compartment open to dry after cleaning it.</p> <p>It is best to use the cleaning function.</p> <p>→ "Cleaning function" on page 24</p> <p>Note: Food residues can cause white deposits to form. These are harmless and do not affect how the appliance works.</p> <p>Remove using lemon juice if required.</p>
<p>Glass cover for the interior lighting</p>	<p>Hot soapy water:</p> <p>Clean with a dish cloth and then dry with a soft cloth.</p> <p>If the cooking compartment is heavily soiled, use oven cleaner.</p>
<p>Door cover</p>	<p>made from stainless steel:</p> <p>Use stainless steel cleaner. Follow the manufacturers' instructions. Do not use stainless steel care products.</p> <p>made from plastic:</p> <p>Clean using hot soapy water and a dish cloth. Dry with a soft cloth. Do not use glass cleaner or a glass scraper.</p> <p>Remove the door cover for cleaning</p>
<p>Rails</p>	<p>Hot soapy water:</p> <p>Soak and clean with a dish cloth or brush.</p>
<p>Pull-out system</p>	<p>Hot soapy water:</p> <p>Clean with a dish cloth or a brush.</p>

	Do not remove the lubricant while the pull-out rails are pulled out – it is best to clean them when they are pushed in. Do not clean in the dishwasher
Accessories	Hot soapy water: Soak and clean with a dish cloth or brush. If there are heavy deposits of dirt, use a stainless steel scouring pad.
Meat thermometer	Hot soapy water: Clean with a dish cloth or a brush. Do not clean in the dishwasher

Notes

- Slight differences in colour on the front of the appliance are caused by the use of different materials, such as glass, plastic and metal.
- Shadows on the door panels, which look like streaks, are caused by reflections made by the interior lighting.
- Enamel is baked on at very high temperatures. This can cause some slight colour variation. This is normal and does not affect operation.

The edges of thin trays cannot be completely enamelled. As a result, these edges can be rough.

This does not impair the anti-corrosion protection.

Keeping the appliance clean

Always keep the appliance clean and remove dirt immediately so that stubborn deposits of dirt do not build up.

Warning – Risk of fire!

Loose food remnants, fat and meat juices may catch fire. Before using the appliance, remove the worst of the food remnants from the cooking compartment, heating elements and accessories.

Tips

- Clean the cooking compartment after each use. This will ensure that dirt cannot be baked on.

- Always remove flecks of limescale, grease, starch and albumin (e.g. egg white) immediately.
- Use the universal pan for baking very moist cakes.
- Use suitable ovenware for roasting, e.g. a roasting dish.

Cleaning function

Use the "Pyrolytic self-cleaning" function to clean the cooking compartment.

You can choose from three cleaning settings.

Setting	Cleaning level	Duration
1	Light	Approx. 1 hour, 15 minutes
2	Medium	Approx. 1 hour, 30 minutes
3	Intensive	Approx. 2 hours

The dirtier the cooking compartment and the longer the dirt has been there, the higher the cleaning setting should be. It is sufficient to clean the cooking compartment every two to three months. If required, you can clean the oven more frequently. A cleaning cycle requires only approx. 2.5 – 4.7 kilowatt hours.

Notes

- For safety reasons, the appliance door locks automatically once a certain temperature is reached. It cannot be reopened until the n symbol for the locking mechanism on the display goes out.
- The interior lighting does not come on during the cleaning function.

Warning Risk of burns!

- The cooking compartment becomes extremely hot during the cleaning function. Never open the appliance door. Allow the appliance to cool down. Keep children away from the appliance. Risk of burns!
-  The appliance will become very hot on the outside during the cleaning function. Never touch the appliance door. Allow the appliance to cool down. Keep children away from the appliance.

Warning Risk of harm to health!

The cleaning function heats up the cooking compartment to a very high temperature so that food remnants left over from roasting, grilling and baking will burn off. This process releases vapours, which can irritate the mucous membranes. While the cleaning function is running,

keep the kitchen well ventilated. Do not remain in the room for long periods. Keep children and pets away. Follow the instructions even when using the Delayed start function with a delayed end time.

Prior to initiating the cleaning function

While cleaning is in progress, you can clean an accessory at the same time, e.g. the universal pan or the baking tray. Before cleaning is started, remove the worst dirt. Slide the accessory in at level 2.

Clean the inside of the appliance door and along the surface edges of the cooking compartment in the area around the seal. Do not scrub the seal and do not remove!

Note: When using the cleaning function, you can clean the enamel accessory provided at the same time. You cannot clean any of the wire racks when using the

cleaning function. The wire racks are not suitable for cleaning using the cleaning function; this will discolour them. Further accessories suitable for cleaning using the cleaning function are listed in the table for special accessories. → *"Accessories" on page 12*

Warning Risk of fire!

- Loose food residues, grease and meat juices may catch fire during the cleaning function. Before starting the cleaning function, remove coarse dirt from the cooking compartment and from the accessories. Risk of fire!
- The appliance will become very hot on the outside during the cleaning function. Never hang combustible objects, e.g. tea towels, on the door handle. Do not place anything against the front of the appliance. Keep children away from the appliance. Risk of fire!
- If the door seal is damaged, a large amount of heat will be generated around the door. Do not scrub or remove the seal. Never operate the appliance if the seal is damaged or missing.

Warning – Risk of serious damage to health!

The appliance will become very hot during the cleaning function. The non-stick coating on baking trays and tins is destroyed and noxious gases are released. Never clean non-stick baking trays and baking tins using the cleaning function. Only clean enamelled accessories using the cleaning function.

Setting the cleaning function

Before setting the cleaning function, ensure that you have followed all instructions for preparation.

The duration of each cleaning setting is preset and cannot be changed.

1. Touch the **Menu** field.

The list of operating modes is displayed.

2. Touch the "Pyrolytic self-cleaning" text field.

The cleaning setting is highlighted in white in the display.

3. Turn the rotary selector to set the cleaning setting.

The end time is calculated automatically.

4. Press the  Start/Stop button to start.

The duration counts down in the display. The heating line does not appear for the cleaning function.

The cleaning function starts.

Ventilate the kitchen when the cleaning function is running.

The appliance door locks shortly after the function starts running. A message and the  symbol appear on the display.

When the cleaning function has ended, an audible signal sounds. The duration 00 m 00 s is shown in the display. Press the  On/Off button to switch off the appliance.

The appliance door cannot be reopened until the  symbol for the locking mechanism goes out.



Setting a later end time

You can set a later end time. Before starting the appliance, touch the "End" text field and set a later end time using the rotary selector.

The appliance switches to standby after it is started. The end time can no longer be changed.

Changing and cancelling

After starting the appliance, the cleaning setting can no longer be changed.

If you would like to cancel the cleaning function, switch the appliance off using the  On/Off button. You can no longer pause the operation using the  Start/Stop button.

The appliance door remains locked until the  symbol for the locking mechanism on the display goes out.

Once the cleaning function has ended

Once the cooking compartment has cooled down, use a damp cloth to wipe off the ash that has been left behind in the cooking compartment, in the accessories on the racks and around the appliance door.

Wipe the pull-out rails with a damp cloth. Then slide the pull-out rails in and out several times. After cleaning, some discolouration may remain on the pull-out rails. This has no effect on performance.

Note: Very bad soiling may cause white deposits to remain on the enamel surfaces. This is residue from the food and is harmless. It does not affect performance. You can remove these residues using lemon juice if required.

Rails

With good care and cleaning, your appliance will retain its appearance and remain fully functional for a long time to come. This will tell you how to remove the shelves and clean them.

Detaching and refitting the rails

Warning – Risk of burns!

The rails become very hot. Never touch the hot rails. Always allow the appliance to cool down. Keep children away from the appliance.

Detaching the rails

1. Lift the rail slightly at the front **a** , and detach it **b** (figure **1**).

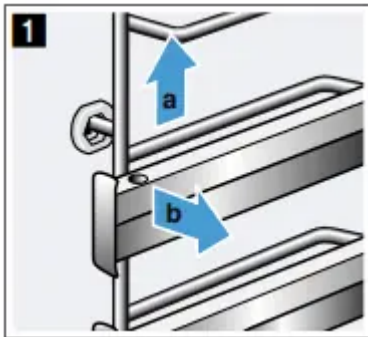

2. Then pull the whole rail towards you and take it out (figure **2**).

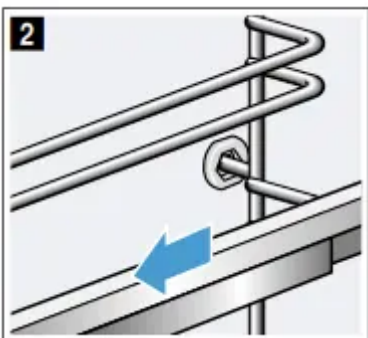

Clean the rails with cleaning agent and a sponge. For stubborn deposits of dirt, use a brush.

Attaching the rails

The rails only fit on the right or the left side. The pull-out rails must pull out towards you.

1. First, insert the rail in the middle of the rear socket **a**, until the rail rests against the cooking compartment wall, and push it back **b** (figure **1**).

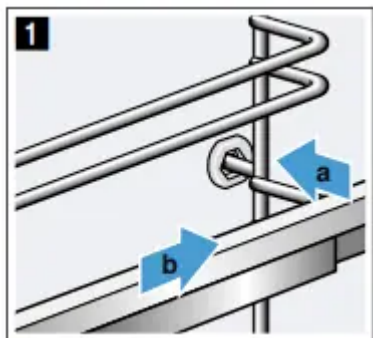

2. Then insert the rail into the front socket **c**, until the rail also rests against the cooking compartment wall here, and press it downwards **d** (figure **2**).

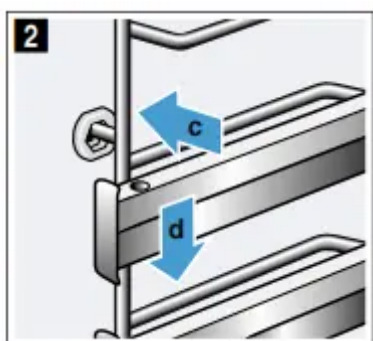

Appliance door

With good care and cleaning, your appliance will retain its appearance and remain fully functional for a long time to come. This will tell you how to remove the appliance door and clean it.

Removing and fitting the appliance door

For cleaning purposes and to remove the door panels, you can detach the appliance door.

The appliance door hinges each have a locking lever. When the locking levers are closed (figure **1**), the appliance door is secured in place. It cannot be detached.

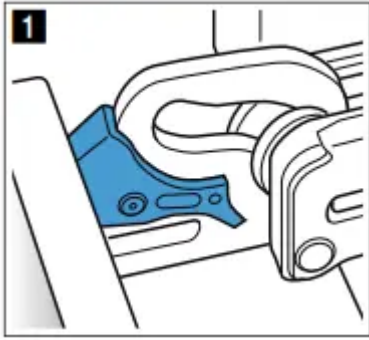

When the locking levers are open in order to detach the appliance door (figure **2**), the hinges are locked. They cannot snap shut.

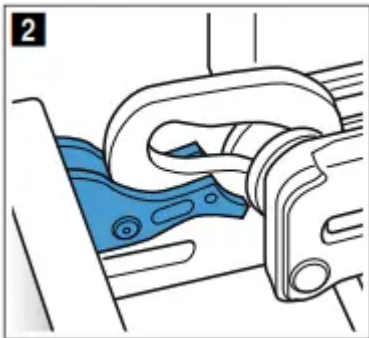

Warning Risk of injury!

- If the hinges are not locked, they can snap shut with great force. Ensure that the locking levers are always fully closed or, when detaching the appliance door, fully open. Risk of injury!
- The hinges on the appliance door move when opening and closing the door, and you may be trapped. Keep your hands away from the hinges.

Removing the appliance door

1. Open the appliance door fully and push it in the direction of the appliance.
2. Fold up the two locking levers on the left and right (figure **1**).

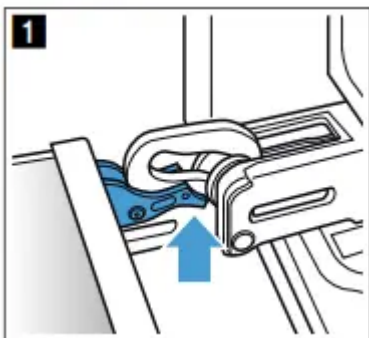

3. Close the appliance door as far as it goes **a**. With both hands, grip the door on the left- and right-hand side and pull it up and out (figure **2**)

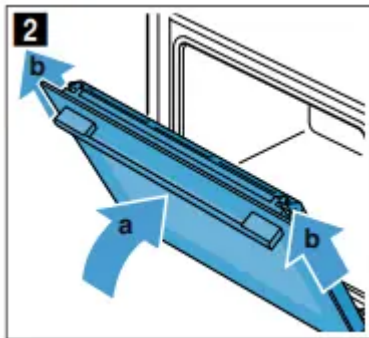

Fitting the appliance door

Reattach the appliance door in the opposite sequence to removal.

1. When attaching the appliance door, ensure that both hinges are inserted straight into the opening (figure **1**).

Place both hinges at the bottom on the outer panel and use this as a guide.

Ensure that the hinges are inserted into the correct opening. You must be able to insert them easily and without resistance. If you can feel any resistance, check that the hinges are inserted into the correct opening.

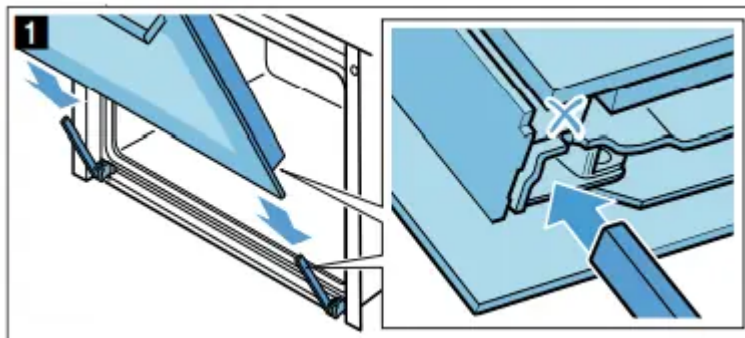

2. Open the appliance door fully. Fold both locking levers closed again (figure **2**).

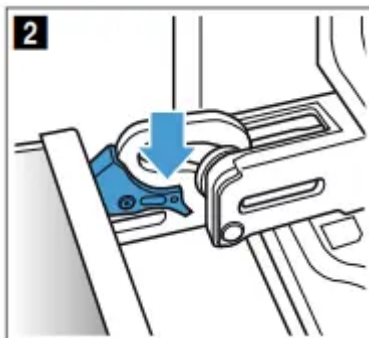

3. Close the cooking compartment door.

Removing the door cover

The stainless steel inlay in the door cover may become discoloured. To carry out thorough cleaning, you can remove the cover. → "Cleaning" on page 22

1. Open the appliance door slightly.
2. Press on the right and left side of the cover (figure **1**).

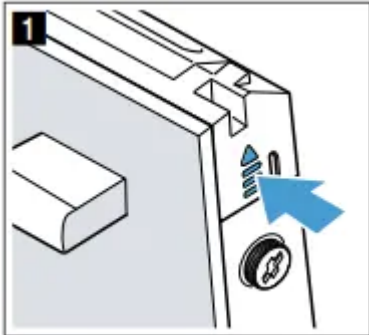

3. Remove the cover (figure **2**).

Close the appliance door carefully.

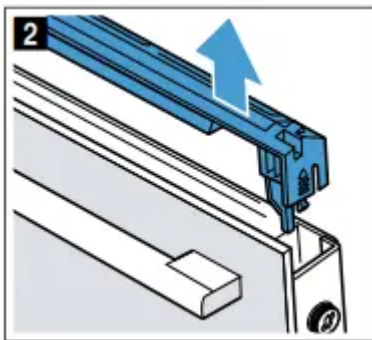

Note: Clean the stainless steel inlay in the cover with stainless steel cleaner. Clean the rest of the door cover with soapy water and a soft cloth.

4. Open the appliance door again slightly. Put the cover back in place and press on it until it clicks audibly into place (figure **3**).

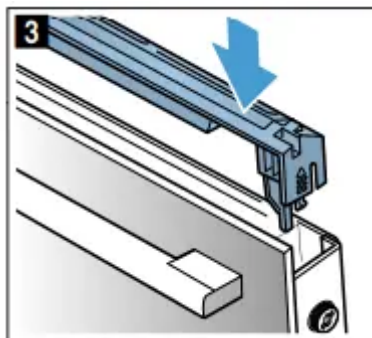

5. Close the appliance door.

Removing and installing the door panels

To facilitate cleaning, you can remove the glass panels from the appliance door.

Removing the door from the appliance

1. Open the appliance door slightly.
2. Press on the right and left side of the cover (figure **1**).

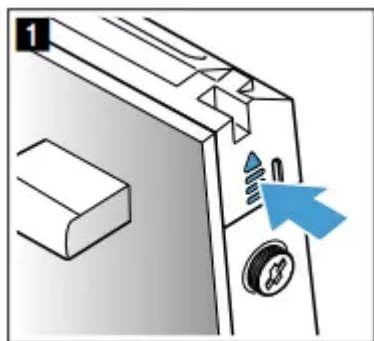

3. Remove the cover (figure **2**).

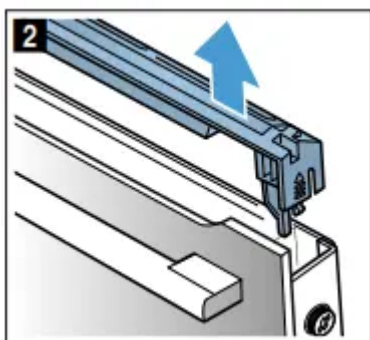

4. Loosen and remove the screws on the left and right of the appliance door (figure **3**).

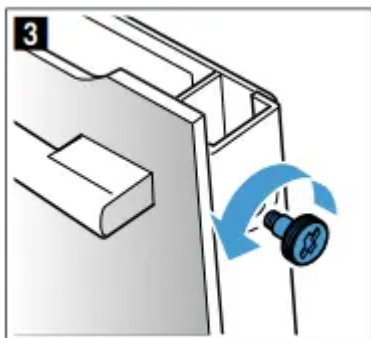

5. Before closing the door again, trap a tea towel which has been folded several times in the door (figure **4**). Pull out the front panel upwards and lay it on a flat surface with the door handle facing downwards.

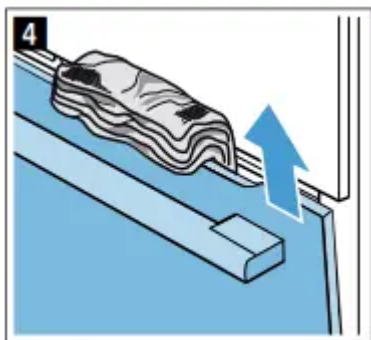

6. Push both retainers on the intermediate panel upwards, but do not remove it (figure **5**). Hold the panel with one hand. Remove the panel.

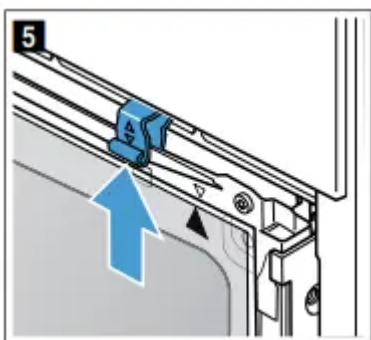

Clean the panels with glass cleaner and a soft cloth.

Warning Risk of injury!

- Scratched glass in the appliance door may develop into a crack. Do not use a glass scraper, sharp or abrasive cleaning aids or detergents.
- The hinges on the appliance door move when opening and closing the door, and you may be trapped. Keep your hands away from the hinges.

Fitting the door on the appliance

When fitting the intermediate panel, make sure that the arrow is in the top right of the panel and that it aligns with the arrow on the metal panel.

1. Insert the intermediate panel at the bottom into the retainer and push it in firmly at the top (figure **1**).

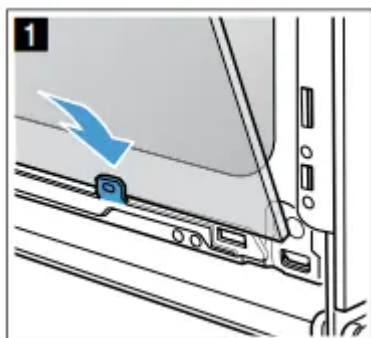

2. Push both retainers downwards (figure **2**).

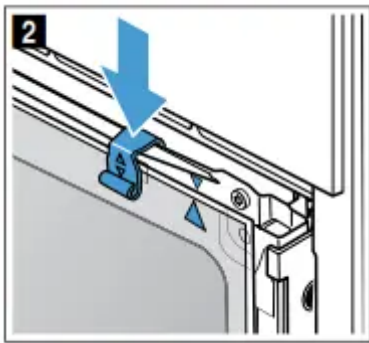

3. Insert the front panel at the bottom into the retainers (figure **3**).

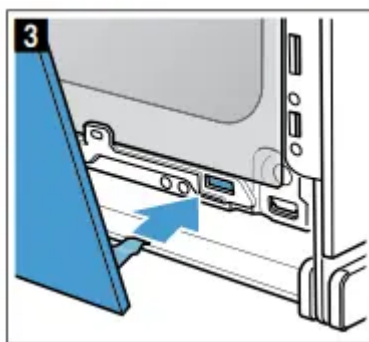

4. Close the front panel until both upper hooks are opposite the opening (figure **4**).

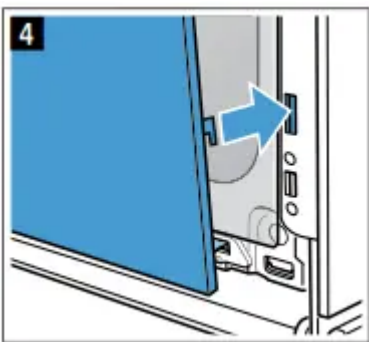

5. Press the front panel at the bottom until it clicks audibly into place (figure **5**).

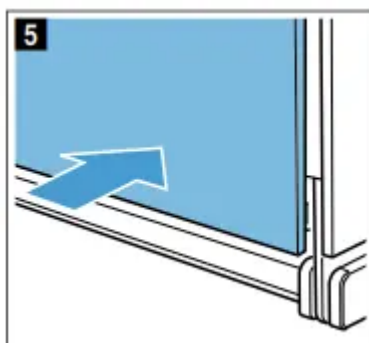

6. Open the appliance door again slightly and remove the tea towel.
7. Screw both screws back in on the left and right.
8. Put the cover back in place and press on it until it clicks audibly into place (figure **6**).

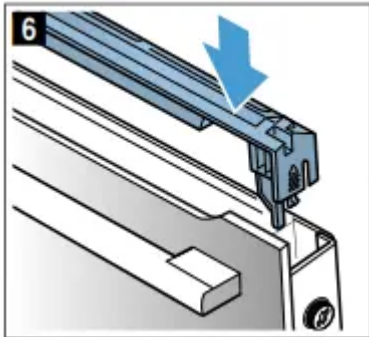

9. Close the appliance door.

Caution! Do not use the cooking compartment again until the panels have been correctly fitted.





Trouble shooting

If a fault occurs, there is often a simple explanation. Before calling the after-sales service, please refer to the fault table and attempt to correct the fault yourself.

Rectifying faults yourself

You can often easily rectify technical faults on the appliance yourself.

If a dish does not turn out exactly as you wanted, you can find many tips and instructions for preparation at the end of the operating manual. → *"Tested for you in our cooking studio" on page 32*

Fault	Possible cause	Notes/remedy
The appliance does not work	Faulty fuse	Check the circuit breaker in the fuse box.
	Power cut	Check whether the kitchen light or other kitchen appliances are working.
"Sprache Deutsch" appears on the display.	Power cut	Reset the language and the time
The time does not appear when the appliance is switched off.	Basic setting is changed.	Change the basic setting for the clock display
The appliance door cannot be opened.	The appliance door is locked with the childproof lock.	Deactivate the childproof lock by pressing the  field for approx. 4 seconds. The lock can be switched off in the basic settings
The appliance door cannot be opened; the  symbol lights up on the display.	The appliance door is locked due to the cleaning function.	Wait until the cooking compartment has cooled and the  symbol goes out.
The appliance does not heat up; the  symbol lights up on the display.	Demo mode is activated in the basic settings.	Briefly disconnect the appliance from the mains (switch off the circuit breaker in the fuse box) and then deactivate demo mode in the basic settings within 3 minutes.
The appliance will not start and "Cooking compartment too hot" appears on the display	The cooking compartment is too hot for the selected dish or type of heating	Allow the cooking compartment to cool down and start again
The rotary selector has fallen out of the support in the control panel.	The rotary selector has been accidentally disengaged.	The rotary selector can be removed. Simply place the rotary selector back in its support in the control panel and push it in so that it

		engages and can be turned as usual.
The rotary selector can no longer be turned easily.	There is dirt under the rotary selector.	<p>The rotary selector can be removed. To disengage the rotary selector, simply remove it from the support. Alternatively, press on the outer edge of the rotary selector so that it tips and can be picked up easily.</p> <p>Carefully clean the rotary selector and its support on the appliance using a cloth and soapy water. Dry with a soft cloth. Do not use any sharp or abrasive materials. Do not soak or clean in the dishwasher.</p> <p>Do not remove the rotary selector too often so that the support remains stable.</p>

Warning – Risk of injury!

Incorrect repairs are dangerous. Do not attempt to repair the appliance yourself. Repairs must only be carried out by one of our trained after-sales engineers. If the appliance is defective, call the after-sales service.

Warning – Risk of electric shock!

Incorrect repairs are dangerous. Repairs may only be carried out and damaged power cables replaced by one of our trained after-sales technicians. If the appliance is defective, unplug the appliance from the mains or switch off the circuit breaker in the fuse box. Contact the after-sales service.

Error messages on the display

When an error message appears on the display with "D" or "E", e.g. D0111 or E0111, switch the appliance off and on again using the  On/Off button.

If it was a one-off error, the display goes out. If the error message appears again, call the after-sales service and quote the exact error message.

Maximum operating time

If you do not change the settings on your appliance for several hours, the appliance stops heating up automatically. This prevents unwanted continuous operation.

The respective settings for the operating mode govern when the maximum operating time is reached.

Maximum operating time reached

A note appears on the display confirming that the maximum operating time has been reached.

To continue operation, touch any field or turn the rotary selector.

Switch the appliance off using the  On/Off button if you do not need to use it.

Tip: Set a cooking time so that the appliance does not switch off when you do not want it to, e.g. with an extremely long preparation time. The appliance heats up until the set cooking time has elapsed.

Replacing the bulb in the top of the cooking compartment

If the cooking compartment light bulb fails, it must be replaced. Heat-resistant, 40 watt, 230 V halogen bulbs are available from the after-sales service or specialist retailers.

When handling the halogen bulb, use a dry cloth. This will increase the service life of the bulb. Only use these bulbs.

Warning – Risk of electric shock!

When replacing the cooking compartment bulb, the bulb socket contacts are live. Before replacing the bulb, unplug the appliance from the mains or switch off the circuit breaker in the fuse box.

Warning – Risk of burns!

The appliance becomes very hot. Never touch the interior surfaces of the cooking compartment or the heating elements. Always allow the appliance to cool down. Keep children at a safe distance.

1. Place a tea towel in the cold cooking compartment to prevent damage.
2. Turn the glass cover anti-clockwise to remove it (figure .

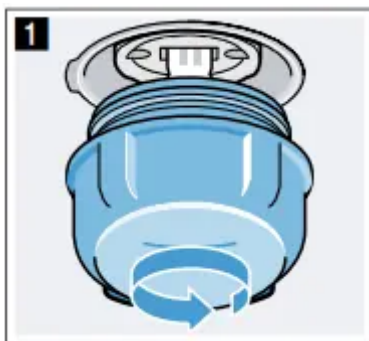

3. Pull out the bulb – do not turn it (figure .

Insert the new bulb, making sure that the pins are in the correct position. Push the bulb in firmly.

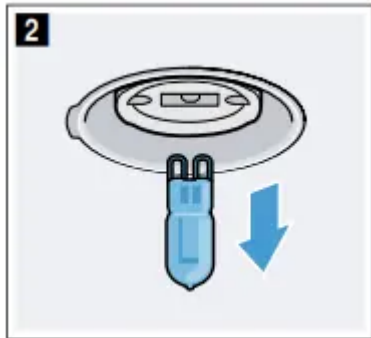

4. Screw the glass cover back on.

Depending on the appliance model, the glass cover may have a sealing ring. If the glass cover has a sealing ring, put it back in place before screwing the cover back on.

5. Remove the tea towel and switch on the circuit breaker.

Glass cover

If the glass cover of the halogen bulb is damaged, it must be replaced. You can obtain a new glass cover from the after-sales service. Please specify the E number and FD number of your appliance

Warning

This content is compiled from multiple sources and is provided for reference purposes only. It may not be complete or fully applicable to all situations. If you are unable to resolve your issue, please contact the product manufacturer or an authorized service provider for official support.