

USING THE REFRIGERATOR

Controls (on some models)

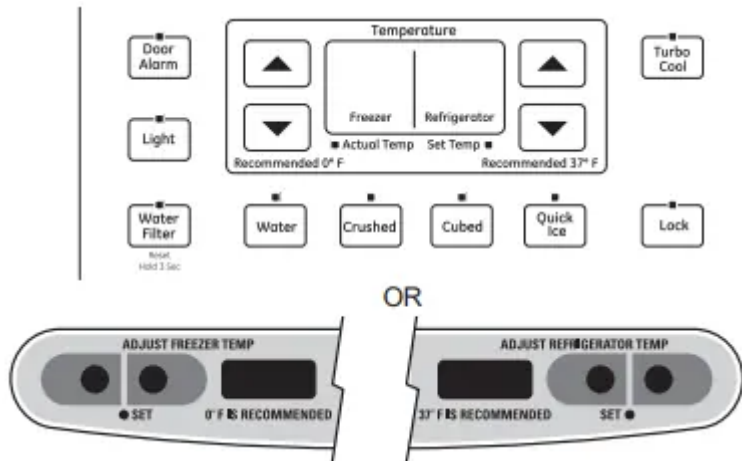

The temperature controls are preset in the factory at 37°F (2.8°C) for the refrigerator compartment and 0°F (-17.8°C) for the freezer compartment. Allow 24 hours for the temperature to stabilize to the preset recommended settings.

The temperature controls can display both the SET temperature as well as the actual temperature in the refrigerator and freezer. The actual temperature may vary slightly from the SET temperature based on usage and operating environment.

- On some models, setting both controls to the warmest setting until the display flashes (off) will stop cooling in both the freezer and refrigerator compartments.
- On other models, setting either control to the warmest setting until the display flashes (off) will stop the cooling to the freezer and refrigerator.
- **NOTE:** Turning the refrigerator off via the controls on the touch panel does not shut off electrical power to the refrigerator.

NOTE: The refrigerator is shipped with protective film covering the temperature controls. If this film was not removed during installation, remove it now.



Performance Air Flow System

The Performance Air-Flow System is designed to maximize temperature control in the refrigerator and freezer compartments. This unique special feature consists of the Air Tower along the back wall of the refrigerator and the Air Tunnel on the bottom portion of the freezer rear wall.

Placing food in front of the louvers on these components will not affect performance.

Although the Air Tower and the Air Tunnel can be removed, doing so will affect temperature performance.

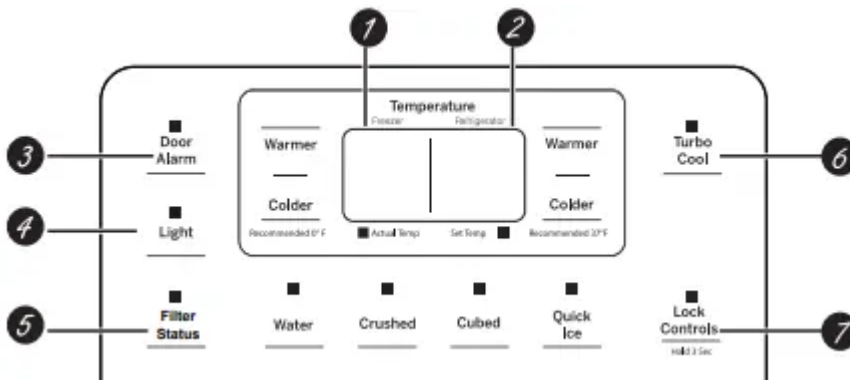

The temperature controls are preset in the factory at 37°F (2.8°C) for the refrigerator compartment and 0°F (-17.8°C) for the freezer compartment. Allow 24 hours for the temperature to stabilize to the preset recommended settings.

The temperature controls can display both the SET temperature as well as the actual temperature in the refrigerator and freezer. The actual temperature may vary slightly from the SET temperature based on usage and operating environment.

1. Freezer Compartment Temperature Control

Adjust freezer compartment temperature. The freezer temperature is preset in the factory at 0°F (-17.8°C). Allow 24 hours for temperature to stabilize to the preset recommended setting.

2. Refrigerator Compartment Temperature Control

Adjust Refrigerator compartment temperature. The refrigerator temperature is preset in the factory at 37°F (2.8°C). Allow 24 hours for temperature to stabilize to the preset recommended setting.

3. Door Alarm (on some models)

To set the alarm, press this pad until the indicator light comes on. This alarm will sound if either door is open for more than 3 minutes. The light goes out and the beeping stops when you close the door.

4. LED dispenser Light

Press the Light pad to turn your dispenser light on and off.

5. Filter Status

Press the Filter Status pad to display the water filter's life percentage (%).

6. TurboCool™ (on some models)

TurboCool™ rapidly cools the refrigerator compartment in order to more quickly cool foods. Use TurboCool™ when adding a large amount of food to the refrigerator compartment, putting away foods after they have been sitting out at room temperature or when putting away warm leftovers. It can also be used if the refrigerator has been without power for an extended period.

NOTES: The refrigerator temperature cannot be changed during TurboCool™.

The freezer temperature is not affected during TurboCool™.

When opening the refrigerator door during TurboCool™, the fans will continue to run if they have cycled on.

7. Lock Controls

Press and hold the Lock Controls pad for 3 seconds to lock out ice and water dispenser and all other controls. Press and hold to unlock the controls

COMPRESSOR

To turn off compressor:

1. Raise the freezer temperature above the highest setting by pressing the Freezer warmer pad until the display starts blinking.
2. Raise the refrigerator temperature above the highest setting until you see OFF.

To turn on the compressor:

1. Press Refrigerator or Freezer colder pad.

NOTE: Compartment lights and the user interface display will stay on.

TurboCool™ (on some models.)

How it Works

TurboCool™ rapidly cools the refrigerator compartment in order to more quickly cool foods. Use TurboCool™ when adding a large amount of food to the refrigerator compartment, putting away foods after they have been sitting out at room temperature or when putting away warm leftovers. It can also be used if the refrigerator has been without power for an extended period.

Once activated, the compressor will turn on immediately and the fans will cycle on and off at high speed as needed for eight hours. The compressor will continue to run until the refrigerator compartment cools to approximately 34°F (1°C), then it will cycle on and off to maintain this setting. After 8 hours, or if TurboCool™ is pressed again, the refrigerator compartment will return to the original setting.

How to Use

Press TurboCool™. The TurboCool™ temperature display will show Tc and the LED will be activated.

After TurboCool™ is complete, the TurboCool™ indicator light will go out.

NOTES: The refrigerator temperature cannot be changed during TurboCool™.

The freezer temperature is not affected during TurboCool™.

When opening the refrigerator door during TurboCool™, the fans will continue to run if they have cycled on.



Water Filter Cartridge - XWFE (On some models)

Water Filter Cartridge

The water filter cartridge holder is located in the back upper-right corner of the refrigerator refrigerator compartment.

Select models use radio frequency identification (RFID) to detect leaks and monitor filter status. The RFID technology is certified by the FCC.

When to Replace the Filter

If there is a replacement indicator light for the water filter cartridge on the dispenser, a red light will start blinking to tell you that you need to replace the filter soon. For models that don't have the indicator light, the filter cartridge should be replaced every six months, or earlier if the flow of water to the dispenser or icemaker decreases.

Removing the Filter

If you are replacing the filter, first remove the previous one by gently grasping the filter and slowly turning it to the left, about a 90° turn. The filter should automatically release itself when you have rotated it far enough to the left. A small amount of water may drip down.

Filter Bypass Plug

To reduce the risk of property damage due to water leakage, you **MUST** use the filter bypass plug when a replacement filter cartridge is not available. Some models do not come equipped with the filter bypass plug. To obtain a free bypass plug, call 800-GECARES. In Canada, call 800.561.3344. The dispenser and icemaker will not operate without either the filter or bypass plug installed. The bypass plug is installed in the same way as a filter cartridge.

Installing the Filter Cartridge in a Side by Side Refrigerator

1. Line up the arrow on the filter with the arrow on the filter cartridge holder. Gently push the top of the new filter up inside the holder.
2. Slowly turn the filter to the right until it stops. **DO NOT OVERTIGHTEN**. As you turn the filter, it will automatically raise itself into position. The filter will move about a 90° turn or 90 degrees.



3. Run water from the dispenser for 2 gallons (7.6 liters) or approximately 5 minutes to clear the system. Water may spurt out and air bubbles may be visible during this process.
4. Press and hold the **RESET WATER FILTER** button on the dispenser for 3 seconds. On select models, filter reset will be automatic when a new filter is installed.

Application Guidelines/Water Supply

Service Flow	0.5 gpm (1.89 lpm)
Water Supply	Potable Water
Water Pressure	25-120 psi (172-827 kPa)
Water Temperature	33°F-100°F (0.6°C-38°C)
Capacity	170 gallons (643.5 liters)

Shelves and Bins

Not all features are on all models.

Refrigerator Door Bins and Freezer Door Tilt-Out Bins

Large Bins

The larger refrigerator door bins and freezer tilt-out door bins are adjustable.

To remove: Lift the front of the bin straight up, then lift up and out.

To replace or relocate: Engage the back side of the bin in the molded supports of the door. Then push down on the front of the bin. Bin will lock in place.

Small Bins

To remove: Lift the front of the bin straight up then out.

To replace: Position the bin above the rectangular molded supports on the door. Then slide the bin down onto the support to lock it in place.

The snugger helps prevent tipping, spilling or sliding of small items stored on the door shelf. Place a finger on either side of the snugger near the rear and move it back and forth to fit your needs.

NOTE: Be careful when placing items in the top bin. Make sure that items do not block or fall into the ice chute.



Slide-Out Shelf (on some models)

The slide-out shelf allows you to reach items stored behind others. The special edges of the spillproof shelf are designed to help prevent spills from dripping to lower shelves.

Spillproof Shelf

To remove: Slide the shelf out until it reaches the stop, then press down on the tab and slide the shelf straight out.



To replace or relocate: Line the shelf up with the supports and slide it into place. The shelf can be repositioned when the door is at 90° or more. To reposition the shelf, slide the shelf past the stops and angle downward. Slide shelf down to the desired position, line up with the supports and slide into place. Make sure you push the shelves all the way back in before you close the door.



Edge-to-Edge Shelf

To remove: With door opened at an angle greater than 90°, slide the shelf out until it reaches the stop tab. Press down on the tab and slide the shelf out until it reaches the shelf's back trim. While keeping the left side of the shelf in contact with the cabinet, pull the shelf down and forward toward the left to remove.



To replace or relocate: With door opened at an angle greater than 90°, align the shelf's back trim against the shelf support. Keeping the left side against the cabinet, slowly lift and gently push the shelf back into place. Reposition the shelf past the stop tabs. Make sure you push the shelves all the way back in before you close the door.



Freezer Baskets (on some models)

To remove, slide out to the stop position, lift the front past the stop position, and slide out. Make sure you push the baskets all the way back in before you close the door.



Freezer Baskets (on some models)

To remove, push the basket all the way to the back of the freezer. Lift up until the back pins are disengaged. Lift the entire basket up and pull out.

Make sure you push the baskets all the way back in before you close the door.



QuickSpace™ Shelf (on some models)

This shelf splits in half and slides under itself for storage of tall items on the shelf below.

This shelf can be removed and replaced or relocated just like Slide-Out Spillproof Shelves.

On some models, this shelf can not be used in the lowest position.



Slide-Out Freezer Shelves

To remove, slide out to the stop position, lift the front past the stop position, and slide out from rib.

Make sure you push the shelves all the way back in before you close the door.



Fixed Freezer Shelves

To remove, lift the shelf up at the left side and then bring the shelf out.

NOTE FOR DISPENSER MODELS: : In order to take full advantage of the tilt-out ice bin (on some models), only store items on the shelf below the ice bin that are no taller than the lowest point on the bin.

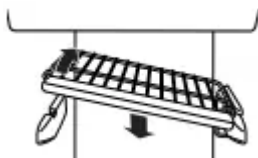

Door Wine/Beverage Rack (on some models)

This rack holds up to 5 cans, one bottle of wine or one 2-liter bottle of soda.

The rack hangs from the sides of the dairy bin.

To remove:

1. Empty the wine/beverage rack.
2. Holding the bottom of the dairy bin, lift the front straight up, then lift up and out.
3. To detach the rack from the dairy bin, pull the rack's side wires out of the holes on each side of the dairy bin.

To replace:

1. Reattach the rack to the sides of the bin.
2. Engage the back side of the bin in the molded supports on the door. Then push down on the front of the bin. The bin will lock into place.



ShelfSaver™ Rack (on some models)

Use this rack to store beverage cans for easy access.

It can also hold a 9" x 13" baking dish.



Door Can Rack (on some models)

This door rack holds up to 9 cans.

NOTE: This rack can only be mounted in the top position under the dairy bin.



Removable Beverage Rack (on some models)

The beverage rack is designed to hold a bottle on its side.

It can be attached to any slide-out shelf.

To install:

1. Line up the large part of the slots on the top of the rack with the tabs under the shelf.
2. Then slide the rack back to lock it in place.

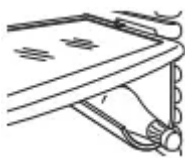

Refrigerator Doors

Refrigerator Doors (on some models)

The refrigerator doors may feel different than the ones you are used to. The special door opening/closing feature makes sure the doors close all the way and are securely sealed.

When opening and closing the door you will notice a stop position. If the door is opened past this stop point, the door will remain open to allow you to load and unload food more easily. When the door is only partially open, it will automatically close.

The resistance you feel at the stop position will be reduced as the door is loaded with food.

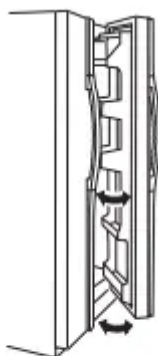

When the door is only partially open,
it will automatically close.
Beyond this stop the door will stay open.

Door Alignment

If doors are uneven, adjust the refrigerator door.

To remove the base grille, open the doors, remove the screw at each end of the base grille and then pull the grille straight out.

1. Using a 7/16" socket wrench, turn the door adjusting screw to the right to raise the door; to the left, to lower it. (A nylon plug, imbedded in the threads of the pin, prevents the pin from turning unless a wrench is used.)
2. After one or two turns of the wrench, open and close the refrigerator door and check the alignment at the top of the doors.

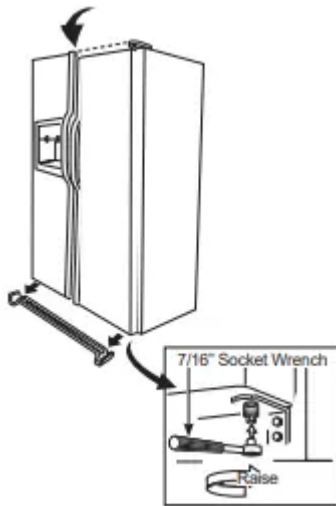

Crispers and Pans

Fruit and Vegetable Crispers

Excess water that may accumulate in the bottom of the drawers should be wiped dry.

On some models, the bottom drawer has full extension slides that allow full access to the drawer.



Adjustable Humidity Crispers

Slide the control all the way to the HI setting to provide high humidity recommended for most vegetables.

Slide the control all the way to the LO setting to provide lower humidity levels recommended for most fruits.



Crisper Removal

Crispers can easily be removed by pulling the drawer straight out and lifting the drawer up and over the stop location.

If the door prevents you from taking out the drawers, first try to remove the door bins. If this does not offer enough clearance, the refrigerator will need to be rolled forward until the door opens enough to slide the drawers out. In some cases, when you roll the refrigerator out, you will need to move the refrigerator to the left or right as you roll it out.



Convertible Deli Pan (on some models)

The convertible deli pan has its own cold air duct to allow a stream of cold air from the freezer compartment or refrigerator compartment to flow to the pan.

The variable temperature control regulates the air flow from the Climate Keeper.

Set the control to the coldest setting to store fresh meats. Set the control to cold to convert the pan to normal refrigerator temperature and provide extra vegetable storage space. The cold air duct is turned off. Variable settings between these extremes can be selected.

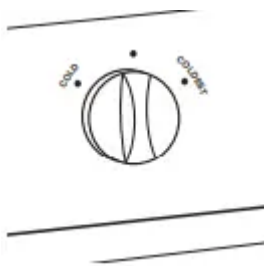

How to Remove and Replace the Drawer

To remove:

1. Pull the drawer out to the stop position.
2. Rotate all four swing locks to the unlock position.
3. Lift the front of the drawer up and out.



To replace:

Make sure all four swing locks are in the unlock position.

Place the sides of the drawer into the drawer supports, making sure the swing locks fit on the drawer slots.

Lock all four swing locks by rotating them to the lock position.



Automatic Icemaker

Automatic Icemaker

The icemaker will produce seven cubes per cycle— approximately 100-130 cubes in a 24-hour period, depending on freezer compartment temperature, room temperature, number of door openings and other use conditions.

If the refrigerator is operated before the water connection is made to the icemaker, set the power switch in the OFF position.

When the refrigerator has been connected to the water supply, set the power switch to the ON position.

The icemaker will fill with water when it cools to 15°F (-10°C). A newly installed refrigerator may take 12 to 24 hours to begin making ice cubes.

You will hear a buzzing sound each time the icemaker fills with water.

Throw away the first few batches of ice to allow the water line to clear.

Be sure nothing interferes with the sweep of the feeler arm.

When the bin fills to the level of the feeler arm, the icemaker will stop producing ice. It is normal for several cubes to be joined together.

If ice is not used frequently, old ice cubes will become cloudy, taste stale and shrink.



Special note about dispenser models:

- Some models have a tilt-out ice bin. The bin can be tilted out as shown in the illustrations, and it will hold itself up while you take ice out or turn the icemaker power switch on and off. Be sure to put the bin back in place before closing the door.
- To restore your ice level from an empty bucket stage, the following steps are recommended:

1. 12 hours after the first batch of ice has fallen into the bin, dispense 3 to 4 cubes.
2. After an additional 6 hours, dispense 3 to 4 cubes again.

These steps will restore your ice level in the shortest amount of time.

NOTE: In homes with lower than average water pressure, you may hear the icemaker cycle multiple times when making one batch of ice.

Accessing Ice and Reaching the Power Switch on Dispenser Models

There are two types of ice storage bins on dispenser models. One has a shelf above the bin, the other does not.

Special note for models with tilt-out ice bin:

There are two types of ice storage bins on dispenser models. One has a shelf above the bin, the other does not.

Special note for models with tilt-out ice bin:

- These models have a tilt-out ice bin. The bin can be tilted out as shown in the illustrations, and it will hold itself up while you take ice out or turn the icemaker power switch on and off. Be sure to put the bin back in place before closing the door.

NOTE: In order to take full advantage of the tilt-out ice bin, only store items on the shelf below the ice bin that are no taller than the lowest point on the bin.

Models with tilt out ice bin

To access ice and reach the icemaker power switch:

1. Lift the bin, then pull it forward until the bin stops.





2. Lower the bin to access ice or reach the power switch.



Models with a shelf above the ice bin

To access ice, pull the bin forward.

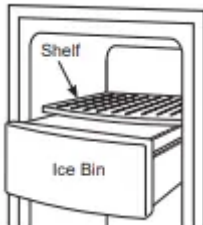

To reach the power switch, pull the shelf straight out. Always be sure to replace the shelf.



On some models, to access ice or reach the power switch:

1. Pull the bin forward until the bin stops.



2. Lower the bin to access ice or reach the power switch.



Removing Ice Bin (dispenser models)

CAUTION The ice bin is heavy when full.

Set the power switch to the OFF position before removing the bin.

When replacing the bin, be sure to press it firmly into place. If it does not go all the way back, remove it and rotate the drive mechanism 1/4 turn. Then push the bin back again.



Ice and Water Dispenser (on some models.)

Using the Dispenser

Select CUBED ICE .

CRUSHED ICE  or WATER .

Press the glass gently against the top of the dispenser cradle.

The spill shelf is not selfdraining. To reduce water spotting, the shelf and its grille should be cleaned regularly.

If no water is dispensed when the refrigerator is first installed, there may be air in the water line system. Press the dispenser arm for at least two minutes to remove trapped air from the water line and to fill the water system. To flush out impurities in the water line, throw away the first six glassfuls of water.



CAUTION Laceration Hazard

- Never put fingers or any other object into ice crusher discharge opening. Doing so can result in contacting the ice crushing blades and lead to serious injury or amputation
- Use a sturdy glass when dispensing ice. A delicate glass may break and result in personal injury.



Locking the Dispenser

Press the LOCK pad for 3 seconds to lock the dispenser and control panel. To unlock, press and hold the pad again for 3 seconds.

Dispenser Light

This pad turns the light in the dispenser on and off. The light also comes on when the dispenser cradle is pressed. For models with a bulb, if the light burns out, it should be replaced with a 6 watt 12V maximum bulb. For LED models, contact Factory Service.



Quick Ice (on some models)

When you need ice in a hurry, press this pad to speed up ice production. This will increase ice production for the following 48 hours or until you press the pad again.



Door Alarm (on some models)

To set the alarm, press this pad until the indicator light comes on. This alarm will sound if either door is open for more than 3 minutes. The light goes out and the beeping stops when you close the door.



Water Filter (on some models)

The Filter Indicator Light will turn yellow when the filter is nearing expiration., and red when the filter is expired. After you replace the water filter, press and hold the Reset Filter pad for 3 seconds until the light turns off to reset the timer.



Filter Status (on some models)

Press the Filter Status pad to display the water filter's life percentage (%).



Important Facts About Your Dispenser

- Do not add ice from trays or bags to the storage drawer. It may not crush or dispense well.
- Avoid overfilling glass with ice and use of narrow glasses. Backed-up ice can jam the chute or cause the door in the chute to freeze shut. If ice is blocking the chute, poke it through with a wooden spoon.
- Beverages and foods should not be quick-chilled in the ice storage drawer. Cans, bottles or food packages in the storage drawer may cause the icemaker or auger to jam.
- To keep dispensed ice from missing the glass, put the glass close to, but not touching, the dispenser opening.
- Some crushed ice may be dispensed even though you selected CUBED ICE. This happens occasionally when a few cubes accidentally get directed to the crusher.
- After crushed ice is dispensed, some water may drip from the chute.
- Sometimes a small mound of snow will form on the door in the ice chute. This condition is normal and usually occurs when you have dispensed crushed ice repeatedly. The snow will eventually evaporate

Care and Cleaning

Cleaning the Inside

To help prevent odors, leave an open box of baking soda in the refrigerator and freezer compartments. Unplug the refrigerator before cleaning. If this is not practical, wring excess moisture out of sponge or cloth when cleaning around switches, lights or controls.

Use warm water and baking soda solution— about a tablespoon (15 ml) of baking soda to a quart (1 liter) of water. This both cleans and neutralizes odors. Rinse and wipe dry.

Use of any cleaning solution other than that which is recommended, especially those that contain petroleum distillates, can crack or damage the interior of the refrigerator.

Do not clean glass shelves or covers with warm water when they are cold. Glass shelves and covers may break if exposed to sudden temperature changes or impact such as bumping or dropping. Tempered glass is designed to shatter into many small pieces if it breaks.

Do not wash any plastic refrigerator parts in the dishwasher.

The chill/thaw tray is dishwasher safe.

Behind the Refrigerator

Be careful when moving the refrigerator away from the wall. All types of floor coverings can be damaged, particularly cushioned coverings and those with embossed surfaces.

Pull the refrigerator straight out and return it to position by pushing it straight in. Moving the refrigerator in a side direction may result in damage to the floor covering or refrigerator.

When pushing the refrigerator back, make sure you don't roll over the power cord or icemaker supply line (on some models).

Preparing for Vacation

For long vacations or absences, remove food and unplug the refrigerator. Clean the interior with a baking soda solution of one tablespoon (15 ml) of baking soda to one quart (1 liter) of water. Leave the doors open.

Set the icemaker power switch to the OFF position and shut off the water supply to the refrigerator.

If the temperature can drop below freezing, have a qualified servicer drain the water supply system (on some models) to prevent serious property damage due to flooding.

Preparing to Move

Secure all loose items such as shelves and drawers by taping them securely in place to prevent damage.

When using a hand truck to move the refrigerator, do not rest the front or back of the refrigerator against the hand truck. This could damage the refrigerator. Handle only from the sides of the refrigerator.

Be sure the refrigerator stays in an upright position during moving.

Replacing the lights on models with LED lighting (on some models)

Setting the controls to OFF does not remove power to the light circuit. Not all features are on all models.

Refrigerator Compartment

There is an LED lighting display in the top and sides of the refrigerator compartment and in the rear and side of the freezer compartment on some models.

If this assembly needs to be replaced, call GE Appliances Service at 1.800.432.2737 in the United States or 1.800.561.3344 in Canada.



Troubleshooting Tips

Save time and money! Review the charts on the following pages first and you may not need to call for service.

Problem	Possible Causes	What To Do
Filter Status Indicator LED turns amber	Filter reaching expired state	Press the Filter Status pad to show remaining filter life.
Filter Status Indicator LED turns red	Filter expired	<p>Press the Filter Status pad to show remaining filter life.</p> <p>If the display shows 0%, the filter needs to be replaced.</p> <p>When the unit has detected a new filter (a filter has been replaced) the Filter Status LED will flash 3 times and then remain off to indicate the filter was successfully replaced.</p>
<p>LEAK or scrolling "LEAK" on the display Water is disabled</p> <p>Filter Status indicator LED flashing red Buzzer sound</p>	Filter leak detected	<p>Replace filter.</p> <p>Wipe off the filter/ surrounding area if there is any water from filter replacement.</p>
<p>"Err" on the display</p> <p>Water is disabled</p> <p>Filter Status indicator LED flashing red Buzzer sound</p>	<p>Filter is not detected</p> <p>No communication with filter</p>	<p>Verify you have the XWFE filter and not the XWF.</p> <p>Verify there are no scratches or filter label damage.</p> <p>Replace filter if filter label shows damage.</p>
Refrigerator beeps when pressing dispenser paddle	<p>Filter is not properly installed</p> <p>Filter water leak</p>	Replace filter or make sure the water filter is properly installed (see water filter section).
Refrigerator does not operate	Refrigerator in defrost cycle.	Wait about 30 minutes for defrost cycle to end.

	Freezer control in OFF position.	Move the freezer control to a lower temperature setting.
	Refrigerator is unplugged.	Push the plug completely into the outlet
	The fuse is blown/circuit breaker is tripped.	Replace fuse or reset the breaker.
	Refrigerator is in showroom mode.	Unplug the refrigerator and plug it back in.
Vibration or rattling (slight vibration is normal)	Rollers need adjusting.	See Rollers.
Motor operates for long periods or cycles on and off frequently. (Modern refrigerators with more storage space and a larger freezer require more operating time. They start and stop often to maintain even temperatures.)	Normal when refrigerator is first plugged in.	Wait 24 hours for the refrigerator to completely cool down.
	Often occurs when large amounts of food are placed in refrigerator.	This is normal.
	Door left open.	Check to see if package is holding door open.
	Hot weather or frequent door openings.	This is normal.
Refrigerator or freezer compartment too warm	Temperature controls set at the coldest setting.	See Controls.
	Temperature control not set cold enough.	See Controls.
	Warm weather or frequent door openings.	Set the temperature control one step colder. See Controls.
	Door left open.	Check to see if package is holding door open.
	Door left open	Check to see if package is holding door open.

Frost or ice crystals on frozen food (frost within package is normal)	Too frequent or too long door openings.	
Divider between refrigerator and freezer compartments feels warm	Automatic energy saver system circulates warm liquid around front edge of freezer compartment.	This helps prevent condensation on the outside
Automatic icemaker does not work	Icemaker switch is in the 2)) position.	Slide the switch to the ON position.
	Water supply turned off or not connected.	See Installing the water line.
	Freezer compartment too warm.	Wait 24 hours for the refrigerator to completely cool down.
	Piled up cubes in the storage bin cause icemaker to shut off.	Level cubes by hand.
	Ice cubes stuck in icemaker.	Turn off the icemaker, remove cubes and turn the icemaker back on.
	Filter is not properly installed. Filter water leak	Replace filter or make sure the water filter is properly installed (refer to water filter section).
Ice cubes have odor/taste	Ice storage bin needs cleaning.	Empty and wash bin. Discard old cubes.
	Food transmitting odor/taste to ice cubes.	Wrap foods well.
	Interior of refrigerator needs cleaning.	See Care and cleaning.
Small or hollow cubes	Water filter clogged.	Replace filter cartridge with new cartridge or with plug.
Slow ice cube freezing	Door left open.	Check to see if package is holding door open.

	Temperature control not set cold enough.	See Controls.
Frequent “buzzing sound”	Icemaker switch is in the ON position, but the water supply to the refrigerator has not been connected.	Set the switch to the OFF position. Keeping it in the ON position will damage the water valve.
Red / Orange glow in the freezer section, steam coming from vents. Popping/ hissing sound coming from the freezer area.	This is normal operation for glass defrost heater models. The heater is clearing out frost from your refrigerator evaporator for optimum operation.	Do not touch the vent area or unplug the refrigerator. It is normal operation and the heater will turn off once the frost has been cleared.
Cube dispenser does not work (on some models)	Icemaker or water supply turned off	Turn on icemaker or water supply.
	Ice cubes are frozen to icemaker feeler arm.	Remove cubes.
	An item is blocking or has fallen into the ice chute inside the top bin of the freezer.	Remove any item that might be blocking, or has fallen into the chute.
	Irregular ice clumps in storage container.	Break up with fingertip pressure and discard remaining clumps.
		Freezer may be too warm. Adjust the freezer control to a colder setting, one position at a time, until clumps do not form.
Dispenser is LOCKED.	Press and hold the Lock pad for 3 seconds.	
Water has poor taste/odor (on some models)	Water dispenser has not been used for a long time.	Dispense water until all water in system is replenished.
Water in first glass is warm (on some models)	Normal when refrigerator is first installed	

		Wait 24 hours for the refrigerator to completely cool down.
	Water dispenser has not been used for a long time.	Dispense water until all water in system is replenished.
	Water system has been drained.	Allow several hours for replenished supply to chill.
Water dispenser does not work (on some models)	Water supply line turned off or not connected.	See Installing the water line.
	Water filter clogged.	Replace filter cartridge or remove filter and install plug.
	Air may be trapped in the water system.	Press the dispenser arm for at least two minutes.
	Dispenser is LOCKED.	Press and hold the Lock pad for 3 seconds.
Water spurting from dispenser	Newly-installed filter cartridge.	Run water from the dispenser for 3 minutes (about 1 1/2 gallons).
Water is not dispensed (on some models) but icemaker is working	Water in reservoir is frozen.	Call for service.
	Refrigerator control setting is too cold.	Set to a warmer setting.
No water or ice cube production	Supply line or shutoff valve is clogged.	Call a plumber.
	Water filter clogged.	Replace filter cartridge or remove filter and install plug.
	Dispenser is LOCKED.	Press and hold the LOCK CONTROLS pad for 3 seconds.
	Filter is not properly installed.	Replace filter or make sure the water filter is properly



	Filter water leak	installed (refer to water filter section).
CUBED ICE was selected but CRUSHED ICE was dispensed (on some models)	Last setting was CRUSHED ICE.	A few cubes were left in the crusher from the previous setting. This is normal.
Refrigerator has odor	Foods transmitting odor to refrigerator.	Foods with strong odors should be tightly wrapped. Keep an open box of baking soda in the refrigerator; replace every three months.
	Interior needs cleaning.	See Care and cleaning.
Moisture forms on outside of refrigerator	Not unusual during periods of high humidity.	Wipe surface dry.
Moisture collects inside (in humid weather, air carries moisture into refrigerator when doors are opened)	Too frequent or too long door openings.	This is normal for the beverage center.
	Due to the higher humidity in the refrigerator, you may on occasion experience fog or small amounts of moisture in the refrigerator compartment	This is normal for the beverage center loads and environmental conditions change with a paper towel if desired.
Interior light does not work	No power at outlet.	Replace fuse or reset the breaker.
	Light bulb burned out.	See Replacing the light bulbs.
	For LED lights	Call Service.
Water on kitchen floor or on bottom of freezer	Cubes jammed in chute.	Poke ice through with a wooden spoon.
Hot air from bottom of refrigerator	Normal air flow cooling motor. In the refrigeration process, it is normal that heat be expelled in the area under the refrigerator. Some floor coverings are	This is normal.

	sensitive and will discolor at these normal and safe temperatures.	
Refrigerator never shuts off but the temperatures are OK.	Adaptive defrost keeps compressor running during door openings.	This is normal. The refrigerator will cycle off after the door remains closed for 2 hours.
Refrigerator is beeping	Door is open.	Close door.
Door not closing properly	Door gasket on hinge side sticking or folding over.	Apply petroleum jelly on face of gasket
Actual temperature not equal to Set temperature	Unit just plugged in.	Allow 24 hours for system to stabilize.
	Door open for too long	Allow 24 hours for system to stabilize.
	Warm food added to refrigerator	Allow 24 hours for system to stabilize.
	Defrost cycle is in process	Allow 24 hours for system to stabilize.

Warning

This content is compiled from multiple sources and is provided for reference purposes only. It may not be complete or fully applicable to all situations. If you are unable to resolve your issue, please contact the product manufacturer or an authorized service provider for official support.

