

Identification of Parts

Body

* Picture might be different by model.

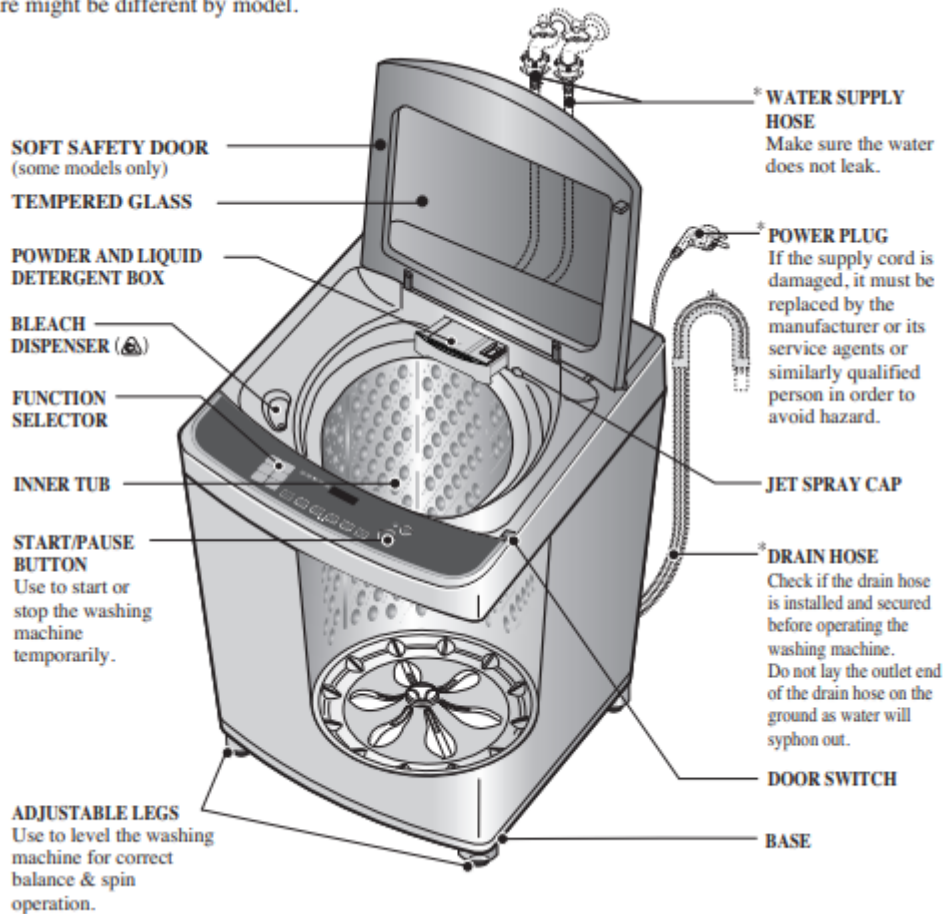

Use of Water, Dispenser Drawer, Detergent, Bleach and Softener

Using Water

Amount of WATER LEVEL

- This machine detects the weight of the of laundry automatically, then sets the Water Level and indicates the recommended amount of detergent to be added by the detergent level indicator.
- When you select a wash program, the Water Level will be shown on the control panel.
- The following table shows the amount of water.
- When the Water Level is automatically detected, it may differ depending on the quantity of laundry even though the same Water Level is indicated on the control panel. If bulky light weight items are loaded, then it may be necessary to increase the water level manually.



NOTE

[Minimum water amount]

The washer has the ability to detect the weight of the clothes to determine the appropriate water level, but cannot detect the volume of clothes, therefore it will be necessary to increase the water level manually to avoid linting and tangling when washing bulky light weight loads.

Water Temperature

- When washing in COLD water additional steps may be needed:
 - Adjust Detergent amount and pre-dissolve Detergent in WARM water
 - Pretreat spots and stains
 - Soak heavily soiled items
 - Use appropriate bleach

* Temperature below 18°C will not activate laundry additives and may cause linting & soap residue, poor cleaning, etc. In addition, Detergent manufactures and care labels define COLD water as 26~29°C. If the temperature of the water in the tub is too cold for your hands, the Detergent will not activate and clean effectively

NOTE If iron is present in the water the clothes may become an all-over yellow or they may be stained with brown or orange spots or streaks. Iron is not always visible. Installation of a water softener or an iron filter may be necessary for severe cases.

Using Dispenser Drawer

Using the Dispenser Drawer

- Liquid Fabric Softener
- Liquid or Powder Low-Sudsing, High-Efficiency Detergent

The dispenser automatically dispenses additives at the proper time in the wash cycle.

1. Slowly open the dispenser drawer by pulling the drawer out until it stops.
2. After adding laundry products, slowly close the dispenser drawer. Closing the drawer too quickly could result in early dispensing of additives.

- Avoid overfilling or splashing when adding laundry products to the dispenser. Doing so could result in early dispensing of laundry products.

At the end of the cycle, you may see water in the compartments. This is part of the normal operation of the washer.

NOTE: Do not use bleach in the dispenser drawer. Powdered detergent should only be used in the soap dispenser compartment. For optimum results, it may be necessary to dilute the Liquid Fabric softener before adding it to the softener dispenser.

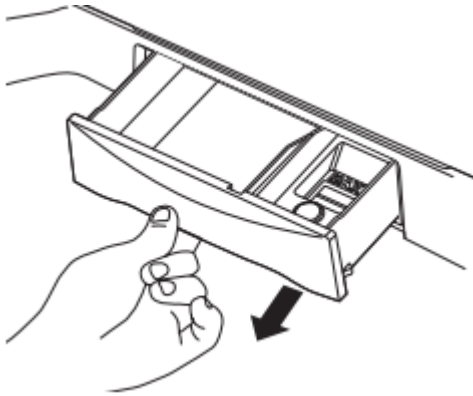

Using Detergent

Detergent

Follow the Detergent package directions. Using too little Detergent is a common cause of laundry problems.

Use more Detergent if you have hard water, large loads, greasy or oily soils or lower Water Temperature.

Choosing the right Detergent

We recommend the use of domestic Detergent, (powder, liquid or concentrated). Soap flakes or granulated soap powders should not be used in your washing machine. When washing woolens remember to use Detergent suitable for washing woolens.

How much Detergent

The correct amount of Detergent will vary depending on the amount of soil in your clothes (Jeans and work clothes may need more Detergent, while bath towels usually need less.).

For liquid and concentrated Detergents, follow the recommendations of the Detergent manufacturer.

Note: To check that you are using the correct amount of Detergent, lift the lid of your machine about half-way through the wash. There should be a thin layer of foam over the surface of the water. Lots of foam may look good, but it does not contribute to cleaning your clothes. No foam means not enough Detergent has been used; soil and lint can settle back on the clothes or the

washing machine. If excess Detergent is used, the rinse will not be as clean and efficient. Also, it could cause environmental pollution, so use it accordingly.

Adding Detergent

Add measured powdered detergent to the detergent compartment of the dispenser drawer.

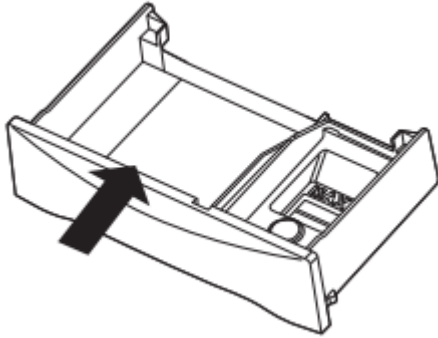

The dispenser drawer **MUST ALWAYS** be in place before you start your washer.

Detergent usage may need to be adjusted for water temperature, water hardness, size and soil level of the load. Avoid using too much detergent in your washer, as it can lead to oversudsing and detergent residue being left on the clothes.

Note : Using Liquid detergent

- Dilute Liquid detergent with water and pour into the tub, start the cycle.
- Delay wash course is not available if you use liquid detergent.



Attention Using liquid detergent without diluting, or leaving laundry for a long time after pouring diluted liquid detergent into the tub might cause damage, bleaching or discoloration of the clothes.

Using Liquid Bleach

- Check clothing care label for special instructions and separate the laundry to be bleached
- Dilute liquid chlorine bleach.
- Measure the recommended amount of liquid bleach carefully following instructions on the bottle.

- Before starting the washer, pour measured amount of bleach directly into bleach dispenser. Avoid splashing or overfilling. Powdered bleach should be mixed with water before pouring.

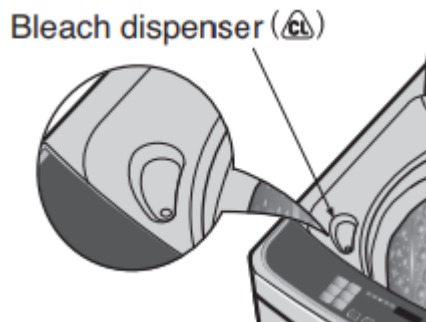

NOTE

- Never pour undiluted liquid bleach directly onto clothes or into the wash basket. This may cause change of color or damage the laundry.
- Do not pour powdered bleach into bleach dispenser.

Using Fabric Softener

If desired, pour the recommended amount of liquid fabric softener into the right-hand compartment.

Use only liquid fabric softener.

Dilute with water to the maximum fill line.

- Do not exceed the maximum fill line.

Overfilling can cause early dispensing of the fabric softener, which could stain clothes.

NOTE : Do not pour fabric softener directly on the wash load. It may stain the clothes.

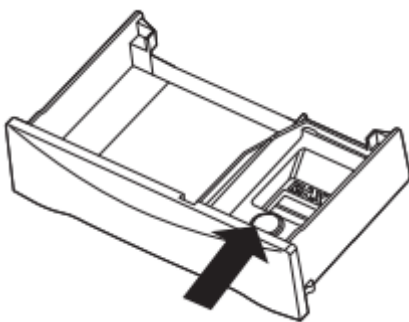

Attention

- Do not mix with Detergent or bleach.
- Never pour fabric softener directly on clothes. It may stain them.
- Do not stop the washer during the first spin for timely dispensing.
- Option washing is not designed to be used with fabric softener dispenser.

Scrud (Waxy Build up)

Scrud is the name given to the waxy build-up that can occur within any washer when the fabric softener comes into contact with Detergent. This build-up is not brought about by a fault in the machine.

If scrud is allowed to build-up in the machine it can result in stains on your clothes or an unpleasant smell in your washer.

If you wish to use fabric softener we recommend

- Using fabric softener sparingly.
- When filling the dispenser, do not splash or overfill.
- Clean dispenser as soon as the cycle is finished.
- Clean your machine regularly. (refer to page 22 or 36)
- Cold water washing increases the chance of this build-up occurring. We recommend a regular WARM or HOT wash e.g. every 5th wash should be at least a warm one.
- Fabric softener with a thinner consistency is less likely to leave residue on the dispenser and contribute to a build-up.

Function of each Button

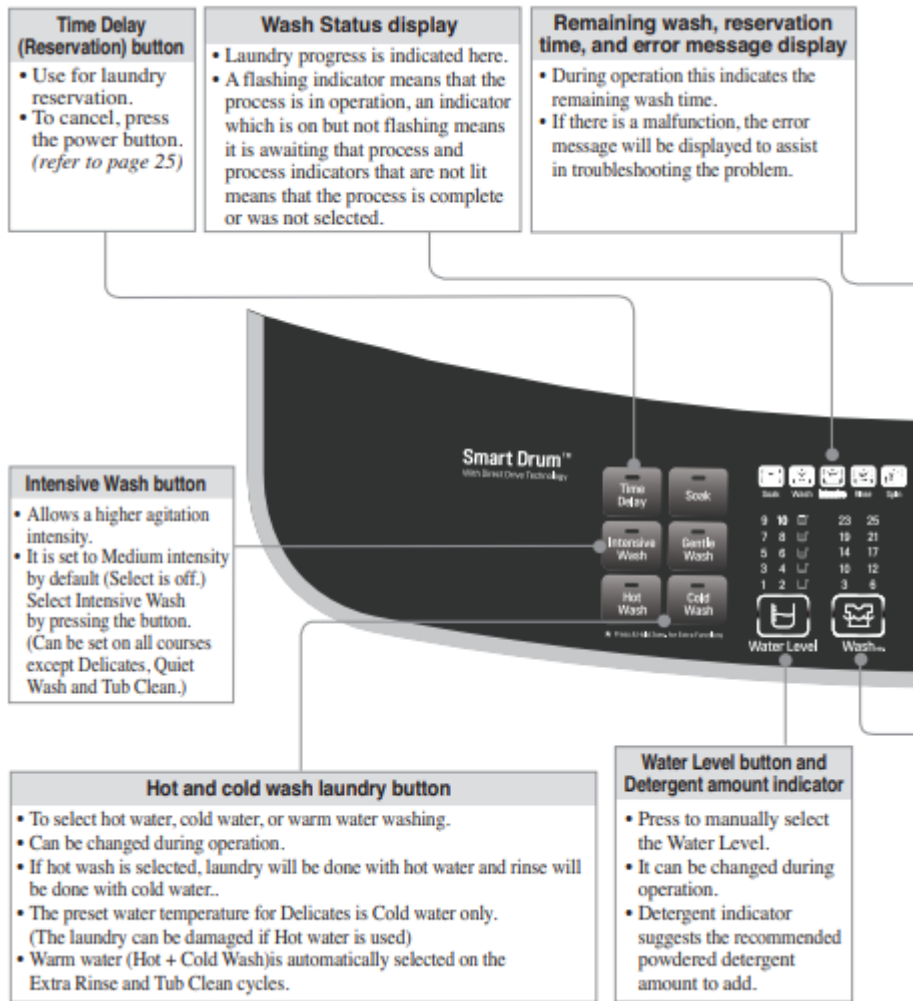

NOTE







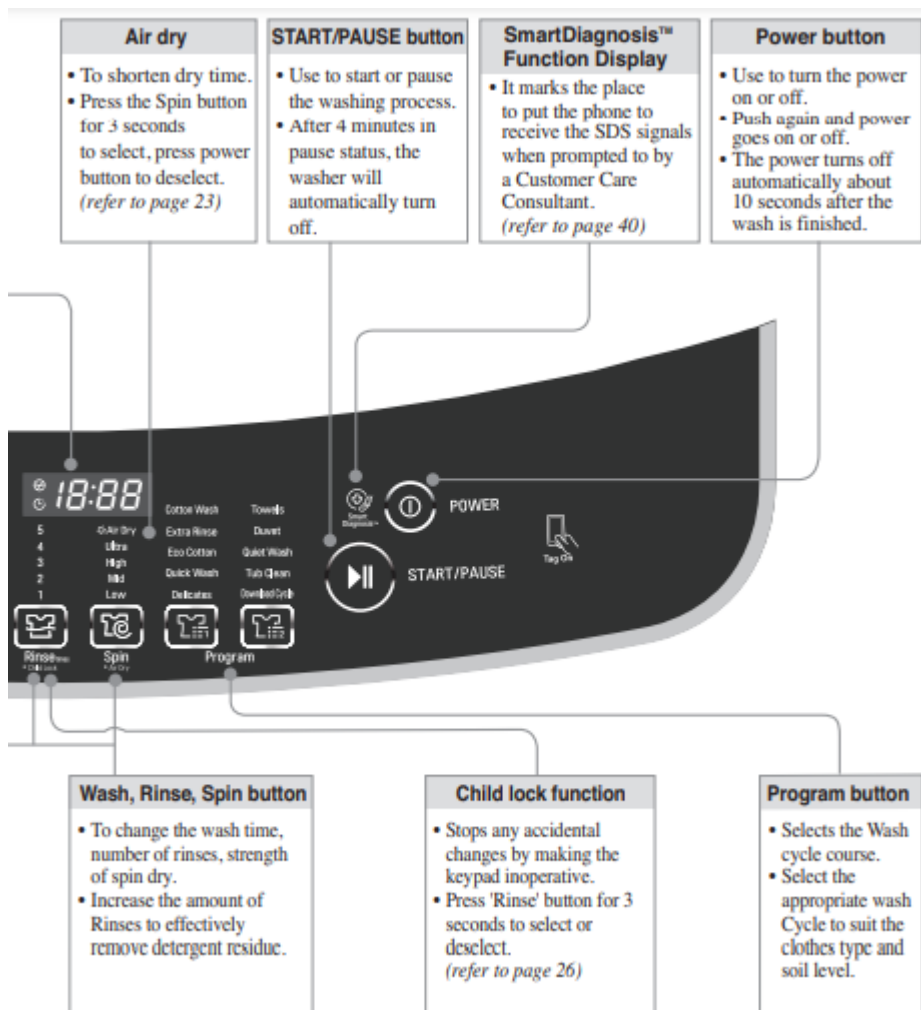





* For optimizing the washing algorithm, the displayed time may change during washing-increased by a maximum of 10 minutes (not including spin irregularity correction time) or decrease by a maximum of 4 minutes.

* The control panel may differ according to different models.





































Washing Programs

















Washing Programs	 POWER	Add the laundry	 Program	Add the Detergent
<p>Cotton Wash</p> <p>Used for Cotton wash loads, this mode automatically selects the most appropriate conditions and completes the sequence in one operation. The built-in sensor detects the weight of the load and the ideal wash power and wash, rinse and spin times are set accordingly.</p>				<p></p> <ul style="list-style-type: none"> The water will commence filling when the wash cycle begins.
<p>Extra Rinse</p> <p>Use this program to increase rinsing performance. This would include underwear and baby clothes. If someone has sensitive skin then this program is recommended to be used.</p>			<p></p> <ul style="list-style-type: none"> Select the Extra Rinse program on the Control panel. 	<p></p> <ul style="list-style-type: none"> Add designated amount of detergent by Water Level and close the door. Use exclusive neutral detergent or dry detergent.
<p>Eco Cotton</p> <p>Eco Cotton cycle consumes less water and electricity to wash normally Soiled cotton loads.</p>			<p></p> <ul style="list-style-type: none"> Select the Eco Cotton program on the Control panel. 	<p></p> <ul style="list-style-type: none"> Add the appropriate quantity of Detergent as indicated by the Detergent level indicator. Or follow the Detergent manufacturer's instructions.



Close the lid	 START/PAUSE	Finish	Caution & Note
 <ul style="list-style-type: none"> The water will commence filling when the wash cycle begins. 	 <ul style="list-style-type: none"> The tub will repeatedly rotate briefly to detect the weight of the clothes and indicate the set water level. The water level can then be manually increased if necessary. The Detergent level indicator will suggest the detergent amount that should be added. 	 <ul style="list-style-type: none"> When the wash program ends, the buzzer will ring for 10 seconds before the Power goes off automatically. 	<ul style="list-style-type: none"> If water is already in the tub, or putting wet laundry into the tub before starting will increase the Water Level. With lightweight bulky loads, Water Level can be set low. Changes to Water Temperature (Hot Wash/Cold Wash) and wash level are possible during operation. <i>(refer to page 10)</i>
			<ul style="list-style-type: none"> During Rinse, the tub will rotate slowly while water is supplied. The water will drain out after each rise. During spray rinse, it is normal for the water to be drained out simultaneously.
			<p>INFORMATION FOR ENERGY TEST</p> <ul style="list-style-type: none"> Select the water temperature to suit wash cycles. Always follow garment manufacture's care label or instructions when washing. Set program of Eco cotton, Spin Ultra, Rinse 5, Wash 6, Water Level 2. Cold Wash, Hot Wash, Soak 1:00 is for normally soiled load and testing in accordance or in conformity with AS/NZS 2040. 1. The test results depend on water pressure, water hardness, water inlet temperature, room temperature, type and amount of load, degree of soiling utilized detergent, fluctuations in the main electricity supply and chosen additional options. For best washing results, we recommend dilute the detergent powder (Drum Type) in WARM water and pour directly into tub.



Washing Programs	 POWER	Add the laundry	 Program	Add the Detergent
<p>Quick Wash</p> <p>Use this cycle when washing lightly soiled clothes for a short time. This cycle is most effective and should only be used with loads weighing less than 3.0kg.</p>			 <ul style="list-style-type: none"> Select the Quick Wash program on the Control panel. 	 <ul style="list-style-type: none"> Add the appropriate quantity of Detergent as indicated by the Detergent level indicator. Or follow the Detergent manufacturer's instructions.
<p>Delicates</p> <p>Use this program for washing delicate fabrics such as lingerie and woollens. (wash only "water washable" clothes) Before washing your woollens check the care label for the washing instructions.</p>			 <ul style="list-style-type: none"> Select the Delicates program on the Control panel. 	 <ul style="list-style-type: none"> Use neutral Detergent appropriate for the clothes. When washing woollens use a mild Detergent recommend-ed for washing wool.
<p>Towels</p> <p>Use this cycle for Bath towels, bath robes, hand towels etc.</p>			 <ul style="list-style-type: none"> Select the Towels program on the Control panel. 	 <ul style="list-style-type: none"> Add the appropriate quantity of Detergent As indicated by the Detergent level indicator. Or follow the Detergent Manufacturer's instructions.
<p>Duvet</p> <p>Use for blanket or bedclothes or pillow and quilt covers.</p>			 <ul style="list-style-type: none"> Select the Duvet program on the Control panel. 	 <ul style="list-style-type: none"> Pour the detergent directly into the tub after dissolving it with warm water. if Cold water washing can cause detergent residue to remain.
<p>Quiet Wash</p> <p>Use this program to wash quietly in Silent especially during late night and early morning when less noise is preferable.</p>			 <ul style="list-style-type: none"> Select the Quiet wash program on the Control panel. 	 <ul style="list-style-type: none"> Add the appropriate quantity of Detergent as indicated by the Detergent level indicator. Or follow the Detergent manufacturer's instructions.

Close the lid	 START/PAUSE	Finish	Caution & Note
			
			<ul style="list-style-type: none"> • Lay out onto a cool floor or on a hanger covered by a towel to dry these type of clothes. • The Spin intensity or spinning time cannot be changed in this cycle as higher spin speeds can damage delicate clothing.
			<ul style="list-style-type: none"> • When washing bulkier loads the water level should be manually increased to reduce linting and detergent residue.
			<ul style="list-style-type: none"> • Cashmere bedclothes, acrylic blanket, mixed spinning blanket, woolen blanket, infilling (polyester 100), and bed sheets may be damaged if not washed in laundry nets or bags. • Separate bed clothes from general clothes. They may become entangled or ball together and cause abnormal washing, especially if the water level is too low. It can be increased manually during the wash. • Spin dry may take longer if the load becomes lumped together and then attempted to be automatically corrected by the machine, by refilling with water. • Never wash electric blankets, mats, rugs or shoes in the machine as it will cause a malfunction and can damage the machine. • Use laundry bags or nets with items that can inflate with air and float during the wash.
			<ul style="list-style-type: none"> • Quiet wash program has a longer washing time than the Cotton Wash program. • To reduce the overall noise during spin, the spin speed is reduced, therefore the clothes will have a higher moisture level at the end of the wash.

Soak Wash

	<p>Press the POWER button to turn power on.</p>
	<p>Load the clothes and Press the Program button to select the Washing Program.</p> <ul style="list-style-type: none">• Soak is not selectable with the Delicates, Quick Wash programs
	<p>Press the Soak button.</p> <ul style="list-style-type: none">• “Soak” can be selected by pressing the Soak button which then turns on the soak indicator()• Soak selection : 15 ▶ 30 ▶ 45 ▶ 1:00 ▶ 2:00 ▶ 3:00 ▶ off ▶ 15
	<p>Press the rinse and Spin buttons to select the number of Rinses and the Spin speed intensity.</p>
	<p>Add the suggested detergent indicated by the detergent level indicator and close the Lid.</p>
	<p>Press the START/PAUSE button.</p> <ul style="list-style-type: none">• Water will then be supplied and the Soak wash will begin.
	<p>When the Soak wash program ends, the chime will sound for 10 seconds before the Power turns off automatically.</p>

Intensive Rinse

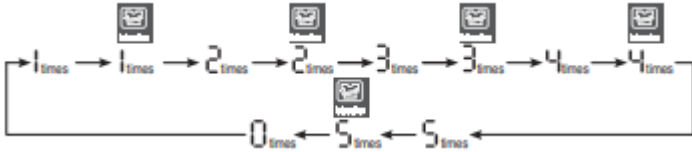
	<p>Press the POWER button to turn power on.</p>
	<p>Load the clothes and Press the Program button to Select the Washing Program.</p> <ul style="list-style-type: none"> • Intensive Rinse can only be selected with the Cotton Wash and Extra Rinse courses.
	<p>Press the Rinse button to scroll through the number of Rinses. The Intensive Rinse will be selected on every second press of the Rinse button and indicated by the Intensive indicator.().</p> 
	<p>Press the Wash and Spin buttons to select the wash time and spin speed intensity.</p>
	<p>Add the suggested detergent indicated by the detergent level indicator and close the Lid.</p>
	<p>Press the START/PAUSE button.</p>
	<p>When the wash program ends, the chime will sound for 10 seconds before the Power turns off automatically.</p>

NOTE

- Use Intensive Rinse to remove detergents more effectively.
- Intensive Rinse will be cancelled if the Water Level is changed during operation.

Air Dry

	<p>Press the POWER button to turn power on.</p> <p>Then load up to 2kg of damp or moist clothes into the tub.</p> <p>This function will have no effect on clothes that are soaking wet.</p>
	<p>Press the Spin button for 3 seconds to select Air Dry.</p> <ul style="list-style-type: none">• Other functions cannot be selected during Air Dry.• This Function is automatically set to 60 minutes upon selection.• Press the Spin button repeatedly to select the duration (90min. ► 120 min. ► 60 min.)• To deselect Air Dry press power button.
	<p>Press the START/PAUSE button.</p>
	<p>When the Air Dry program ends, the chime will sound for 10 seconds before the Power turns off automatically</p>







Notice

When you select Air Dry for more than 60 minutes

- 1) You can reduce the clothes drying time by minimizing the moisture in the clothes, however, this function will not dry clothes completely but will aid the clothes drying time when they are removed from the tub.
- 2) Always keep the laundry amount to 2kg or less and make sure to spread it out evenly.
- 3) Select 60 minutes for cotton clothing and 120 minutes for synthetic fiber clothing for effective Moisture removal.

Option Washing

When you only need the Wash, Wash/Rinse or Rinse cycles, these can be set manually.

1. Press the POWER button to turn power on.		
Wash Only	Rinse Only	Spin Only
<p>Press the Wash button to select the desired wash time.</p>  <p>Wash_{time}</p>	<p>Press the Rinse button to select the desired number of Rinses.</p>  <p>Rinse_{times} * Child Lock</p>	<p>Press the Spin button to select the desired Spin speed intensity.</p>  <p>Spin * Air Dry</p>
Wash and Rinse only	Rinse and Spin Only	Drain Only
<p>Press the Wash button to select the desired wash time.</p>  <p>Wash_{time}</p> <p>Press the Rinse button to select the desired number of Rinses.</p>  <p>Rinse_{times} * Child Lock</p> <p>You can use this option for preventing wrinkles by not allowing the tub to spin after the Rinse.</p>	<p>Press the Rinse button to select the desired number of Rinses.</p>  <p>Rinse_{times} * Child Lock</p> <p>Press the Spin button to select the desired Spin speed intensity.</p>  <p>Spin * Air Dry</p>	<p>Can be used when draining of the remaining tub water in required. Turn on the machine and press the Spin button then press START/PAUSE. The POWER can then be turned off when the remaining water has drained just before the Spin starts.</p>
2.		
3. Press the Water Level button to select the water level according to the amount of laundry. If you do not select a level, it will remain on the middle level default setting. The correct water level is when the clothes are completely submerged in water..		
4. Add the clothes into the washing tub.		
5. Press the START/PAUSE button.		
6. Add the detergent and close the lid.		

NOTE

- When a Wash, Wash/Rinse or Rinse only option is selected, after the wash is completed the water will not be drained out. If you wish to drain the water, but not engage the spin, then follow the above Drain Only instructions, after the Wash, Wash/Rinse or Rinse only program has ended.
- If you do not specify the water level, then Medium will be automatically selected.

Time Delay (RESERVATION) Wash

	<p>Press the POWER button to turn power on.</p>
	<p>Load the clothes and add the powdered detergent to the soap dispenser and Press the Program button to select the desired Washing Program.</p> <ul style="list-style-type: none">• Do not use liquid detergent in the soap dispenser drawer. Doing so will cause it to dispense immediately and harden in the wash tub.• This program will not work in Delicates and Tub Clean Program.
	<p>Press Time Delay (Reservation) button to set the delayed wash ending time.</p> <ul style="list-style-type: none">• If reservation button is pressed, it will turn on the Delay Time indicator and show 3:00. <p>Eg: It is 1:00 PM and you want to finish the laundry by 7:00 PM</p> <ul style="list-style-type: none">• Keep press reservation button to set desired laundry ending time. (1:00 to 7:00 = 6:00 Hours)  <ul style="list-style-type: none">• The Time Delay can be set from 3~18 hours by 1 hour intervals up to 3~12hours and 2 hour intervals for 12~18 hours.• A Time Delay of less than 3 hours cannot be selected.
	<p>Close the door and press the START/PAUSE button.</p> <ul style="list-style-type: none">• The Time Delay indicator will flash and the display will show the set delay time
	<p>The Wash cycle will be completed at the end of the Delayed time indication.</p> <ul style="list-style-type: none">• The end time may vary slightly due to environmental conditions such as water temperature and water inlet pressure.

Notice To cancel any Time Delay setting, press Time Delay (Reservation) button repeatedly until the reservation is canceled or press the POWER button to turn off the power.

Placing and Leveling

Please ensure any foam transit restraint has been removed from the machines packaging before.

1. Place the machine on a flat and firm surface which allows proper clearance.

We suggest a minimum clearance of 2 cm to the right and left sides of the machine for ease of installation.

At the rear, a minimum clearance of 10 cm is suggested.

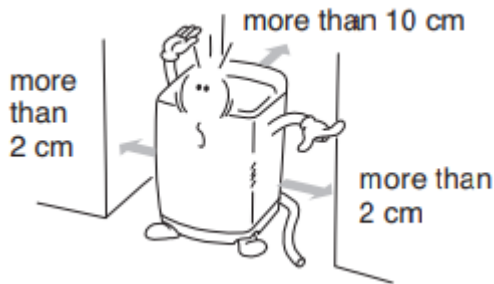

NOTE

If the washer is installed on an uneven, tilted, or weak timber floor causing excessive vibration, a spin failure or “**UE**” error can occur.

It must be placed on a firm and level floor to prevent spin failure.

2. Check that the machine is level

Open the lid and look from above to see if it is same as shown.

Top view of the machine



3. Leveling the machine

Lift the front of the washing machine and twist the appropriate Adjustable Leg until the surface bubble is (some models only) located in the center.

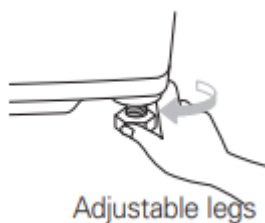

How to use the rubber adjusting plates

- Use the adjusting plates to level the washer when the adjustable legs cannot cover the gap.

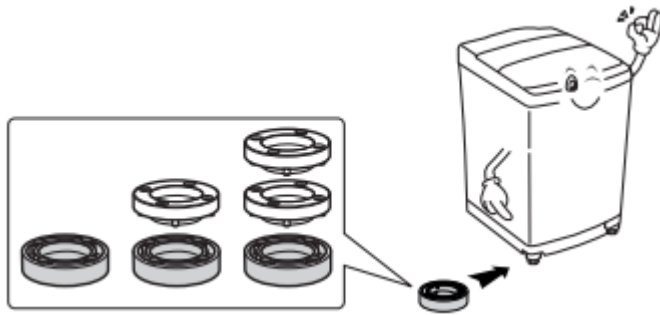

Caution If an extension cord or power board is used, ensure it is positioned so that it is not exposed to water or moisture. This machine should be connected to a 230~240v town mains power outlet.

Cleaning and Maintenance

Cold water washing

- If you always use COLD water, we recommend that a WARM or HOT wash be used at a regular intervals e.g. every 5th wash should be at least a WARM one.

When you have finished

- Turn off taps to prevent the chance of flooding should a hose burst.
- Always unplug the power cord after use. Turning the washer off from the POWER button does not disconnect the main power

When water supply into the tub is not clean or the inlet valve filter is clogged with particles (such as sand), clean the filter in the inlet valve occasionally.

(The image of the power cord and water tap may vary according to the country)

To Clean the Filter in the Inlet Valve

1. Close the taps. Turn on the washer and press START/PAUSE. the washer will attempt to commence washing and release the water in the inlet valves. When there is no more water, turn the power off from the mains outlet switch.



2. Turn off the power before pulling out the cord.



3. After removing the inlet water supply hose pull out the filter. Then use a brush to clean the filter.

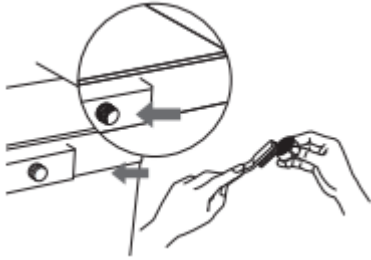

4. Refit the filter after cleaning it and reconnect the inlet hose as per the installation instructions.

NOTE Before reconnecting the inlet hose, turn the tap on for 30 seconds, with the hoses in the sink so that any impurities in the water line can be flushed out.

To Clean the Pump casing (for pump model)

1. Remove the power cord from the power outlet and place a towel on the floor under the drain pump cap. Excess water will flow out.

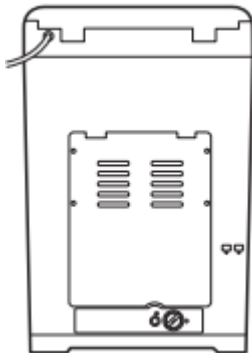

2. Turn the cap counter- clock- wise and pull it out while taking note the configuration.

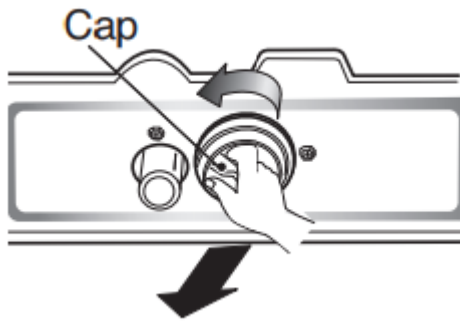

3. Remove any foreign objects and fluff inside pump casing and from the filter.

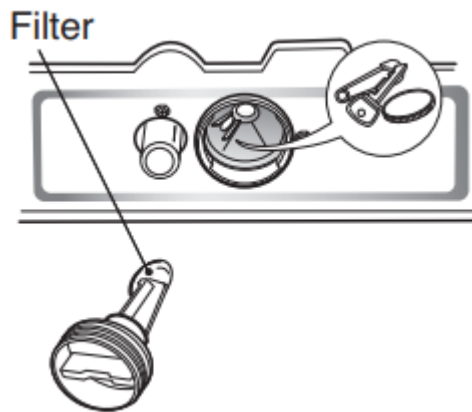

4. Refit the cap. Insert the filter along the guide ribs inside the pump casing. Filter must face the guide ribs inside pump casing and securely turn the cap clockwise.

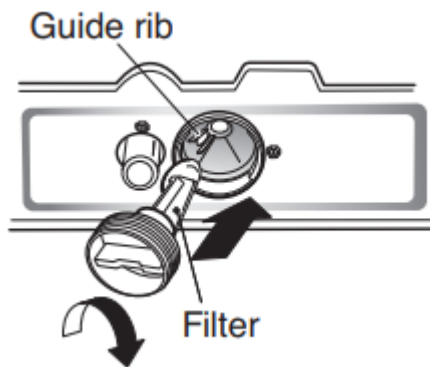

NOTE Check for water leaks after refitting by adding a bucket of water into the tub. (The Rubber O ring must remain in the cap)

When there is a fear of freezing

- Close the water taps and remove the Water Supply Hose.
- Remove the water which remains in the water supply.
- Lower the drain hose and drain the water in the bowl and the drain hose by spinning.

If frozen

- Remove the water supply hose, and immerse it in HOT water at approx.. 40°C.
- Pour approx.. 2 liters of HOT water at approx.. 40°C, into the bowl and let it stand for 10 minutes.
- Connect the water supply hose to the water tap and confirm that the washing machine performs the supply and drainage of water.

Inner Wash tub

Leave the lid open after washing to allow moisture to evaporate. If you want to clean the inner-tub use a clean soft cloth dampened with liquid Detergent, then rinse. (Do not use harsh or gritty cleaners.)

Inlet Hoses

Hoses connecting washer to the tap should be replaced every 5 years

Exterior

Immediately wipe off any spills. Wipe with damp cloth. Try not to hit surface with sharp objects.

Long Vacations

Be sure that the water supply is shut off at the taps. Drain all water from hoses if weather will be below freezing.

Cleaning the Inside of your Washer

If you use fabric softener or do regular COLD water washing, it is very important that you occasionally clean the inside of your washer.

- Fill your washer with HOT water.
- Add about two cups of a powdered Detergent that contains phosphate.
- Let it operate for several minutes.
- Stop the washer, open the lid and leave it to soak overnight.
- After soaking, drain the washer and run it through a normal cycle.

Or use TUB CLEAN PROGRAM periodically.

Do not wash clothes during this procedure.

Products that might damage your washing machine

- Concentrated bleaches and nappy sanitizer will cause damage to the paintwork and components of your washer.
- Hydrocarbon solvents i.e. petrol, paint thinners and lacquer thinners, etc. can dissolve plastic and blister paint (Be careful when washing garments stained with these solvents as they are flammable DO NOT put them in washer or dryer.)

- Some pretreatment sprays or liquids can damage your washer's control panel when applied next to the washer.
- Use of dyes in your washer may cause staining of the plastic components. The dye will not damage the machine but we suggest you thoroughly clean your washer afterwards. We do not recommend the use of dye strippers in your washer.
- Do not use your washer lid as a work surface.

Common washing problems

Many washing problems involve poor soil & stain removal, Lint and scum residue, and fabric damage. For satisfactory washing results, follow these instructions.

WASH PROBLEM

Problems	Possible Causes	Solutions & Preventive Measures
Poor soil removal	<ul style="list-style-type: none"> • Not enough Detergent • Wash Water Temperature too cold. • Overloading the washer • Incorrect wash cycle • Incorrect sorting • Not pretreating stains 	<ul style="list-style-type: none"> • Use correct amount of Detergent for load size, amount of soil and water Hardness. • Different Water Temperature may be required according to soil type. • Reduce load size and manually increase the water level. • Wash with DUVET or SOAK & DUVET wash cycle for heavy soiled items. • Separate heavily soiled items from lightly soiled ones. • Pretreat stains and heavy soil according to directions shown on page 9.
Blue Stains	<ul style="list-style-type: none"> • Undiluted fabric softener dispensed directly onto fabric 	<ul style="list-style-type: none"> • Rub the stain with bar soap. Wash. • Do not overfill fabric softener dispenser and do not pour liquid fabric softener directly onto fabric. <p>See page 12 for more instructions.</p>
Black or gray marks on clothes	<ul style="list-style-type: none"> • A buildup caused by the interaction of fabric 	<ul style="list-style-type: none"> • Keep the recommendations against Scrud(waxy













	<p>softener and Detergent can flake off and mark clothes</p> <ul style="list-style-type: none"> • Not enough Detergent 	<p>buildup). (refer to scrud page12.)</p> <ul style="list-style-type: none"> • Use correct amount of Detergent for load size, amount of soil and water Hardness.
Yellow or brown rust stains	<ul style="list-style-type: none"> • Iron or manganese in water supply, water pipes, or water heater 	<ul style="list-style-type: none"> • To restore discolored load of whites, use rust remover safe for fabric. • Install nonprecipitating water softener or an iron filter in your water supply system for an ongoing problem. • Before washing, run water for a few minutes to clear lines.
Lint	<ul style="list-style-type: none"> • Incorrect sorting • Tissues left in pocket • Overloading the washer 	<ul style="list-style-type: none"> • Wash lint givers eg towels, flannelette sheets, separately from lint collectors eg synthetic fabrics and remove tissues in pockets before wash. See page 9 for sorting and caring before loading. • Do not overload the washer . Manually increase the water level.

Residue or Detergent	<ul style="list-style-type: none"> • Overloading the washer • Undissolved Detergent • Using too much Detergent 	<ul style="list-style-type: none"> • Do not overload the washer. • Some Detergents need to be pre-dissolved, check the Detergent instructions. Try pre-dissolving the Detergent. • Increase Water Temperature using HOT water safe for fabric. • Use proper amount of Detergent.
Holes, tears, or snags	<ul style="list-style-type: none"> • Incorrect use of chlorine bleach. • Unfastened zippers, hooks, buckles • Ribs, tears and broken threads • Overloading the washer • Degradation of fabric 	<ul style="list-style-type: none"> • Never pour chlorine bleach directly on fabric. See page 11 for adding liquid bleach. • Fasten zippers, hooks, and buckles. • Remove objects in pockets. See page 9 for caring before loading. • Do not overload the washer.



Troubleshooting

Before calling for service, check the problem against the list below.

Symptom	Error Message	What to Check
Water Supply Failure		<p>Is the water tap shut off?</p> <p>Is the water supply cut off ?</p> <p>Is the drain hose installed too low?</p> <p>Is the water pressure too high or too low, or is the filter of the inlet valve clogged with impurities?</p> <p>Is the Hot hose connected to cold?</p> <p>Is the Cold hose connected to hot?</p>
Drainage Failure		<p>Is the drain hose positioned correctly?</p> <p>Is the drain hose bent or placed too high?</p> <p>Is the internal part of the hose or drain pump (only pump model) clogged with impurities?</p> <p>Check if electric power has gone off.</p>
Spin Failure		<p>d• Is the laundry evenly balanced?</p> <p>Is the washing machine placed on a flat and level surface?</p> <p>Press the "Start/Pause" button to release the , now distribute the laundry evenly and then press the "Start/Pause" button again to</p>
Door(Lid) Open		<p>Is the lid closed?</p>
Door(Lid) Lock malfunction		<p>Is the lid closed?</p> <p>Make sure that the lid is closed properly and press the START/PAUSE button. The washer will not operate unless the lid is locked.</p> <p>Make sure that nothing is caught under the lid, including shipping material or clothing.</p>
Child Lock		<p>CL(Child Lock) does not indicate a malfunction.</p>

		<p>This function prevents accidental cycle changes or interruptions during the wash cycle. The Child Lock function will remain engaged even after the cycle has finished. Press the Rinse button for 3 seconds to unlock. Take care not to set up inadvertently during use.</p>
Foreign objects		<p>Are there foreign objects, Such as coins, pins, etc., caught between the wash pulsator and the inner tub ?</p> <p>Turn off the washer and then press the Power button.</p> <p>Press the spin speed button without selecting a cycle to drain and spin the load.</p> <p>When the spin is complete, remove the clothes and then find and remove any objects caught in the wash pulsator.</p>
Tub Clean Reminder		<p>Empty the tub, insert bleach into the detergent dispenser and select the Tub Clean cycle.</p> <p>If you want to skip the Tub Clean, press the program and option buttons to select desired cycle. In this case, you will see the message again after a few more wash cycles. Once the Tub Clean cycle is performed,  will disappear until the next reminder to clean the tub.</p>
		<p>Please call your nearest LG Electronics service center for help.</p>

SmartDiagnosis™

<p>1. Close the washer door, and press the POWER button to turn on the machine. (Smart Diagnosis will not operate if the Washer has a power problem.)</p>	
	<ul style="list-style-type: none">• Do not press any buttons other than the ones indicated below.
<p>2. Place the phone to the SmartDiagnosis™ display icon.</p>	
	<ul style="list-style-type: none">• Make sure that the phones mic faces the SmartDiagnosis™ display 
<p>3. Hold down the Cold Wash button to activate smart diagnosis</p>	
	<ul style="list-style-type: none">• Place the phone near the SmartDiagnosis™ display, and hold down the Cold Wash button until tak tat tak sounds are heard. 
<p>4. Hold the phone while data is transmitted.</p>	
	<ul style="list-style-type: none">• Keep the phone placed to the SmartDiagnosis™ display while data for smart diagnosis is being transmitted. The time remaining for data transmission will be displayed on the washer display.• Transmission sound may be irritating. For proper diagnosis, do not remove the phone.
<p>5. After the data transmission is completed, listen to the diagnosis result from the consultant.</p>	
	<ul style="list-style-type: none">• When data transmission is completed, the power is automatically turned off with "End" displayed for a few seconds.

NOTE Smart Diagnosis is a troubleshooting feature designed to assist, not replace, the traditional method of troubleshooting through service calls. The effectiveness of this feature depends upon

various factors, including, but not limited to, the reception of the cellular phone being used for transmission, any external noise that may be present during the transmission, and the acoustics of the room where the machine is located. Accordingly, LG does not guarantee that Smart Diagnosis can accurately troubleshoot any given issue.

Warning

This content is compiled from multiple sources and is provided for reference purposes only. It may not be complete or fully applicable to all situations. If you are unable to resolve your issue, please contact the product manufacturer or an authorized service provider for official support.

Document generated by [ManualsFile](#)

