

Dishwasher Components

	Wash Cycles						
Model	Heavy	Auto	Normal	Speed60®	Half Load	Clean30	Rinse
SHS5AV5#UC*	●	●	●	●	●		●
SHS5AVF#UC*	●	●	●	●		●	●
SHX5AV5#UC*	●	●	●	●			●
SHX5AVF#UC*	●	●	●	●		●	●
SHS5AVL#UC*	●	●	●	●			●
SHX5AVL#UC*	●	●	●	●			●
SHE4AV5#UC*	●	●	●	●			
SHV4AT5#UC*	●	●	●				●

can be any number

	Wash Cycles Options						
Model	Delay	Half Load	Sanitize	ExtraDry	ExtraScrub	ExtraShine®	Delicate
SHS5AV5#UC*	●			●			
SHS5AVF#UC*	●			●			
SHX5AV5#UC*	●	●	●	●			
SHX5AVF#UC*	●	●	●	●			
SHS5AVL#UC*	●	●	●	●	●		
SHX5AVL#UC	●	●	●	●	●		
SHE4AV5#UC*	●	●		●			●
SHV4AT5#UC*	●			●		●	●

* #can be any number



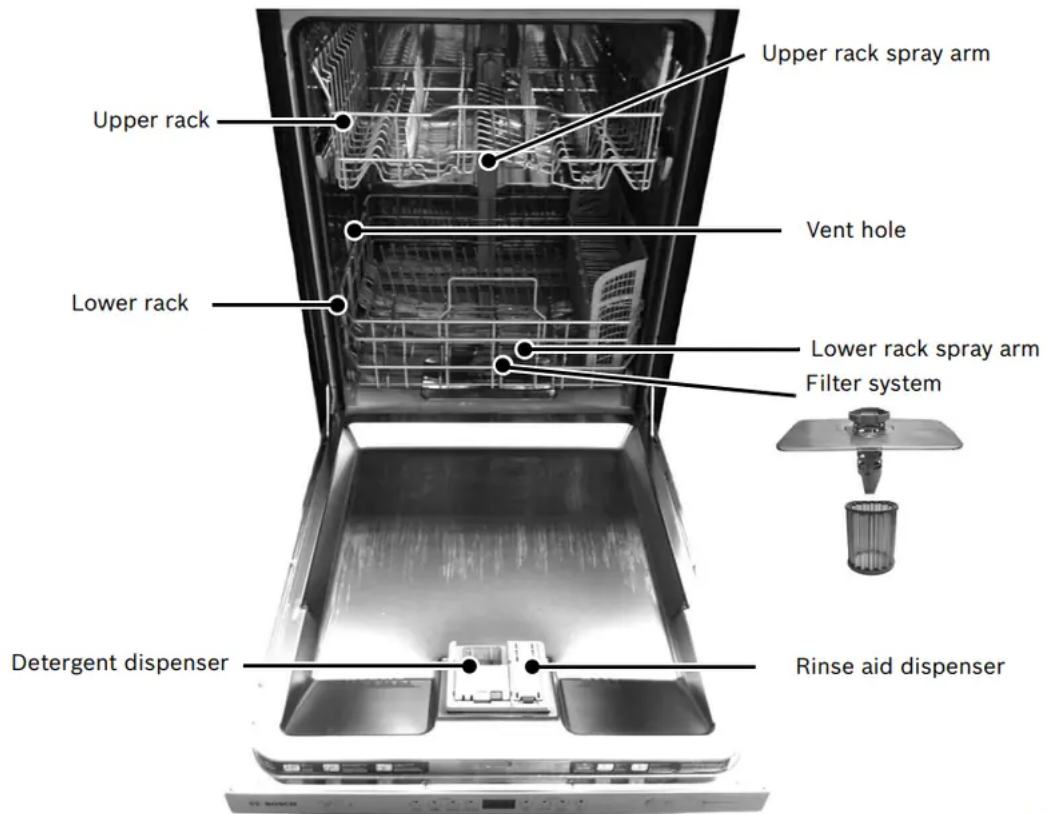

Additional Features	
Self-Latching Door	This feature will hold the door wherever you place it a
LcoSense Wash Management System	Checks water condition and decides it a second fresh
Extra Dry Heat	Raises the temperature of the rinse and increases the
Flow-Through Heater™	Quickly and efficiently heats water to a sanitizing tem
Noise Reduction System	Uses Suspension Motor™, a two-pump motor system dishwasher line in North America.
Nylon Coated Racks	Eliminates cuts and nicks and have five year warranty
OptiDry	This feature senses when the jnit is low on rinse aid a
Triple Filtration System	Uses multiple filters to ensure distribution of clean wa material.



Silverware Basket (model dependent)	Splits along its length resulting in 2 halves which can loading versatility.
Rackmatic® Adjustable Upper Rack	The upper rack can be raised or lowered to accommo
Knife Rack (model dependent)	Fits into the upper rack and allows knives to lay flat fo
Extra Tall Item Sprinkler (model dependent)	Allows you to remove upper rack for extra tall items a
24/7 AquaStop* Leak Protection	If a leak has occurred, it shuts down operation and au
Time Remaining Indicator	Indicates the cycle time remaining.
Delay Start	Start of a cycle can be delayed in 1-hour increments
2 Flip Tine rows in upper rack and 1 in lower rack	Folds down to improve loading versatility.
2 Cup Shelves	Can be used for cups or larger serving utensils.
Low Rinse Aid Notification Light	Illuminates to indicate Rinse Aid is low.
Sanitized Notification Light	Illuminates to indicate sanitation requirements are me

Dishwasher Setup

Detergent

Use only detergent specifically designed for dishwashers. For best results, use fresh powdered dishwashing detergent or detergent tab

The dishwasher uses less water than most, therefore, less detergent is required. With soft water, 1 tablespoon (15 ml) of detergent will clean most loads. The detergent dispenser cup has lines that measure detergent (Figure 1) to 1 tablespoon (15 ml) and 2 tablespoons (25 ml). 3 tablespoons (45 ml) of detergent will completely fill the detergent dispenser.

Figure 1

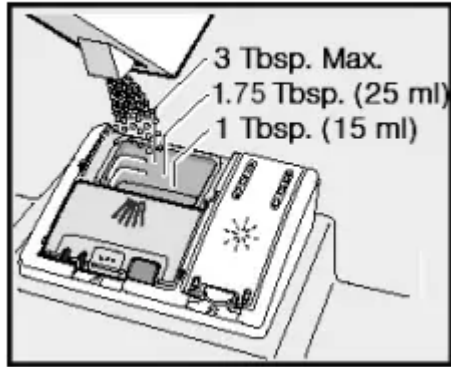

NOTE: If you do not know the hardness of your water supply, use 15 ml (1 tbsp) of detergent. Increase the amount if necessary to the least amount required to get your kitchenware clean. Use the measuring lines in the detergent dispenser cup as a guide to measure the amount of detergent recommended in Table 1.

Table 1- Recommended Detergent Amount

Wash Cycle	Hard Water/ Heavy Soil	Medium Water/ Medium Soil	Soft Water/ Little Soil
Heavy	3 tbsp (45 ml)	3 tbsp (45 ml)	1.75-3 tbsp (25-45 ml)
Auto	1.75-3 tbsp (25-45 ml)	1.75 tbsp (25 ml)	1-1.75 tbsp (15-25 ml)
Normal	1.75-3 tbsp (25-45 ml)	1.75 tbsp (25 ml)	1-1.75 tbsp (15-25 ml)
Speed60®	1.75 tbsp (25 ml)	1-1.75 tbsp (15-25 ml)	1 tbsp (15 ml)
Half Load*	1.75 tbsp (25 ml)	1-1.75 tbsp (15-25 ml)	1 tbsp (15 ml)
Clean30*	1.75 tbsp (25 ml)	1-1.75 tbsp (15-25 ml)	1 tbsp (15 ml)
Rinse*	None	None	None

* Model dependent

To Close:

- Place finger as shown in Figure 2.
- Slide door closed and press down firmly until it clicks.



Figure 2

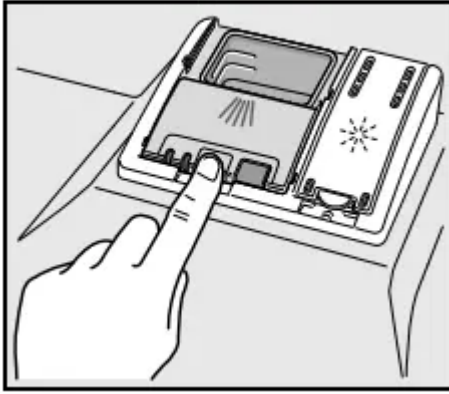

To Open:

- To open the cover, push the button as shown in Figure 3.
- Cover will slide open.

Figure 3

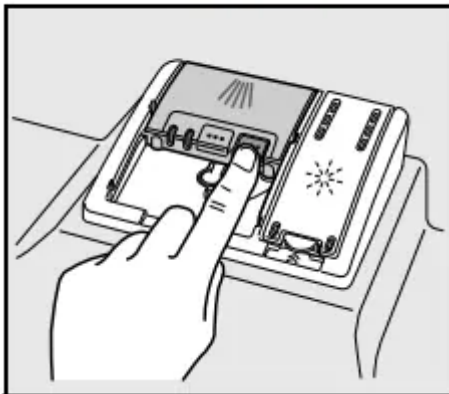

Rinse Aid

To achieve proper drying, always use a liquid rinse aid, even if your detergent contains a rinse aid or drying additive.

NOTE: The dishwasher indicates low rinse aid by turning on the “Refill Rinse Aid” LED in the display. If this light is on, you need to refill the rinse aid dispenser by following the directions below.

Adding Rinse Aid

1. Add liquid rinse aid to the dispenser until it is full (see Figure 4). Do not overfill.
2. Close the lid. Lid must be fully closed until it clicks in order to seal.
3. Wipe up any excess rinse aid that may have puddled when the dispenser reservoir is full.

Figure 4

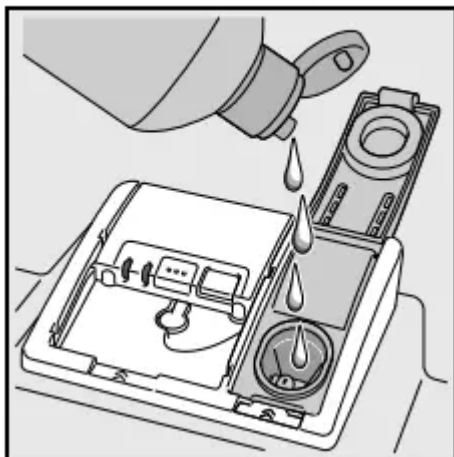

The indicator light will go out a few moments after the dishwasher door is shut. See page 16 for instructions on how to adjust the amount of rinse aid dispensed.

Dishware Materials

NOTE: Before using your dishwasher for the first time, check the information in this section. Some items are not dishwasher safe and should be hand washed; others require special loading.

Recommended:

Aluminum: Colored anodized aluminum may fade over time. Minerals in your water may cause the aluminum to darken or spot. This can usually be removed with a soap-filled steel wool pad.

China, Crystal, Stoneware: Some hand-painted utensils may discolor, fade or spot. Hand wash these utensils. Position fragile glassware so that it will not fall over or come in contact with other utensils during the wash cycle.

Glass: Milk glasses may discolor or become yellow.

Non-stick Coatings: Apply a light coating of vegetable oil to non-stick surfaces after drying.

Plastics: Make sure the plasticware is dishwasher safe.

Stainless Steel, Sterling Silver and Silver Plates: Load these so they do not come in contact with other metals.

Not Recommended:

Acrylic: Cracking, small cracks throughout the acrylic, may occur.

Adhesive-Joined Pieces: Adhesives that join materials such as plastic, wood, bone, steel, copper, tin, etc. may loosen.

Bone-Handled Utensils: Handles may separate.

Iron: Iron will rust. Hand wash and dry immediately.

Non-Dishware Items: Your dishwasher is intended for use in cleaning ONLY standard household dishware and kitchenware.

Pewter, Brass, Bronze: These items will tarnish. Hand wash and dry immediately.

Tin: Tin will stain. Hand wash and dry immediately.

Wood: Wooden bowls, wooden utensils and utensils with wooden handles can crack, warp and lose their finish.

Loading the Dishwasher

Do not pre-wash items with loosely attached soiling. Remove all food particles, bones, toothpicks and excessive grease. Items having burned-on, baked-on or starchy soils may require some pretreatment. Refer to the Dishware Materials section for more information about dishware suitability.

Load only dishwasher safe items into the dishwasher. Load dishes in the dishwasher racks so the insides of bowls, pots and pans are facing the spray arms as shown. Avoid nesting and contact points between dishes. Separate items of dissimilar metals. Use care to not block movement of the spray arms.

Loading the Upper Rack

Ensure items do not protrude through the bottom of the racks and block the spray arms.

NOTE: When pushing the upper rack into the dishwasher, push it until it stops against the back of the tub so the upper rack spray arm connects to the water supply at the back of the tub. Do not push racks in using the door.

Loading the Lower Rack

Place large items in the lower rack. Load pots, pans and bowls upside down. Do not block vent with tall baking sheets. Load these items on the right side of the dishwasher.

Unloading the Dishwasher

When unloading the dishwasher, it is recommended to unload the lower rack first. Next, unload the silverware basket followed by the upper rack. This prevents water from dripping down onto dishware.

NOTE: Dishes are more likely to chip when unloading before cooling

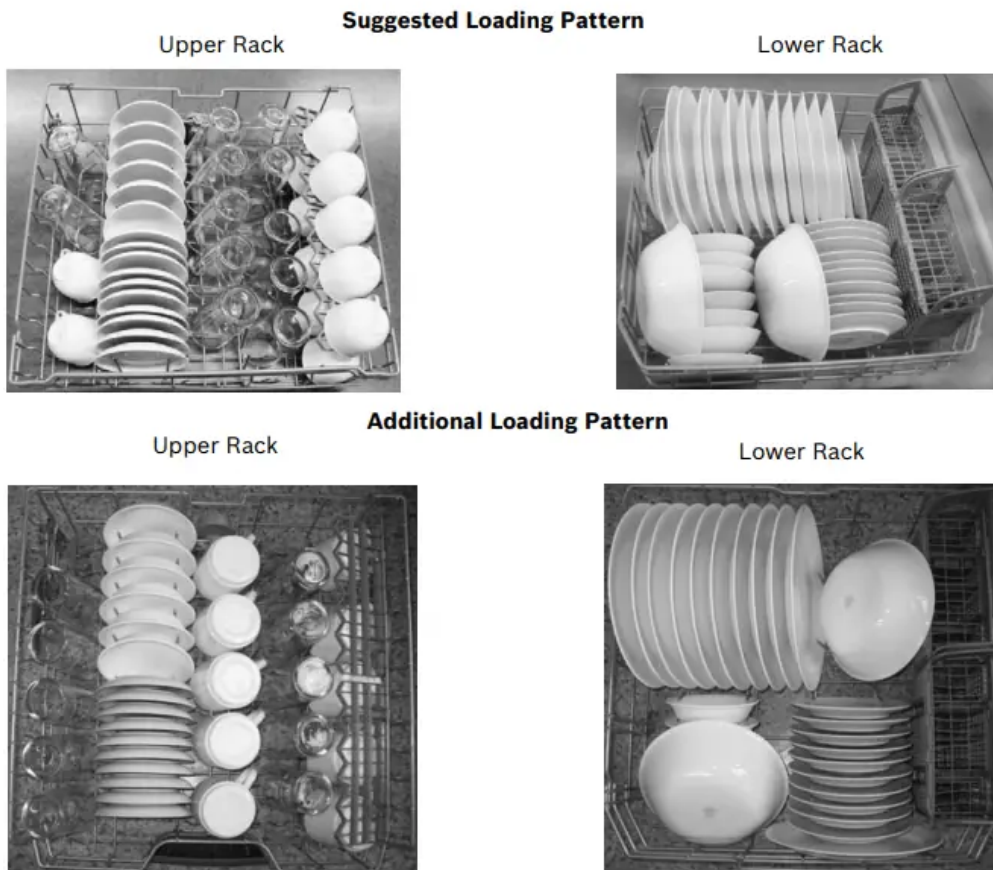

Loading the Silverware Basket

Place knives and sharp utensils with their HANDLES UP and forks and spoons with their handles down. If large or oddly-shaped items are loaded in the silverware basket, be sure they do not nest together.

The Double-Flex™ Silverware Basket (model dependent)

This basket splits along its length, resulting in two halves that may be placed in a variety of positions in the lower rack, greatly increasing the lower rack's loading versatility. The basket snaps together either back to back or end to end as shown.

To split the silverware basket:

Grasp the basket and slide the two halves in opposite directions as shown at right and then pull the two halves apart.

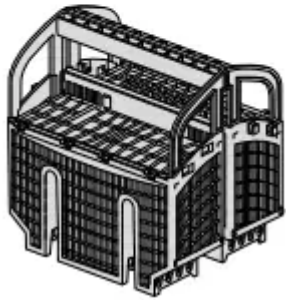
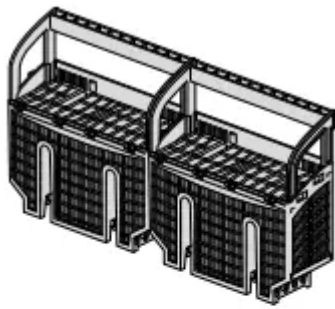

Loading pattern for Double-Flex™ Silverware Basket

1		4	3	3	4	3	4	6	1	1	7	4	3	3	4	3	4	6	1	
1	2	4	3	3	4	3	4	2	1	1	2	4	3	3	4	3	4	2	1	
1	2	2	2	2	2	2	2	2	2	1	1	2	2	2	2	2	2	2	2	1

The Long Silverware Basket (model dependent)

The long silverware basket fits along the side of the lower rack.



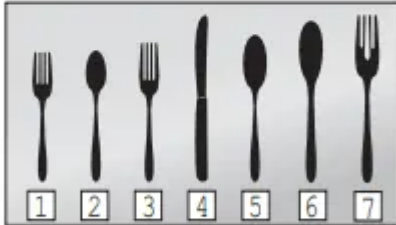

- 1- salad fork
- 2- teaspoon
- 3- dinner fork
- 4- knife
- 5 - tablespoon
- 6 - serving spoon
- 7 - serving fork

Loading pattern for Long Silverware Basket

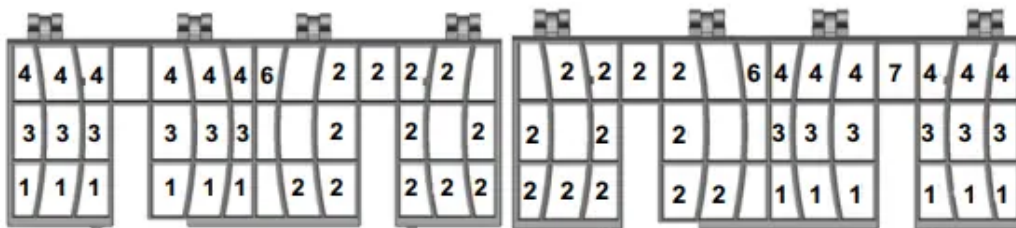

The basket lid may also be snapped to the handle in order to leave the basket open.

Rack Features

Flip Tines

The upper rack consists of two tines that can be folded down depending on what you may need to load in the rack. To fold down, grasp the folding tine and release from notch. Push folding tine downward to desired position as shown in Figure 5.



Figure 5

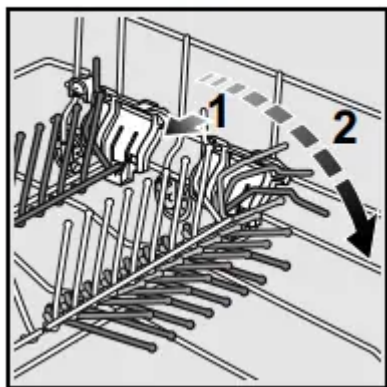

RackMatic® Adjustable Upper Rack

The upper rack can be raised or lowered to accommodate large items in either rack (see Figure 6).

Figure 6

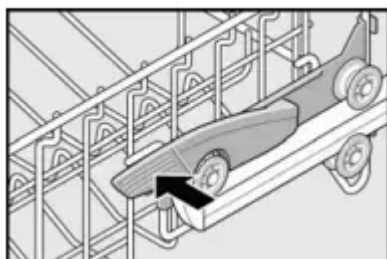

NOTE: Before pushing the upper rack into the dishwasher, ensure the rack height is the same on both sides. If the height is not the same on both sides, the dishwasher door will not shut and the upper rack spray arm will not connect to the water inlet.

To lower the upper rack:

1. Pull the upper rack out of the dishwasher until it stops.
2. Press the RackMatic® adjustable upper rack handles inward and let the rack drop gently.

To raise the upper rack:

1. Pull the upper rack out of the dishwasher until it stops.
2. Grasp the top of the rack above the RackMatic® handles and pull it upward until the handles lock the rack into position (you do not need to press the handles in order to raise the rack).

Plastic Item Clips

Light-weight plastic accessories (cups, lids, etc.) can be held securely by the plastic item clips (see Figure 7).

Figure 7

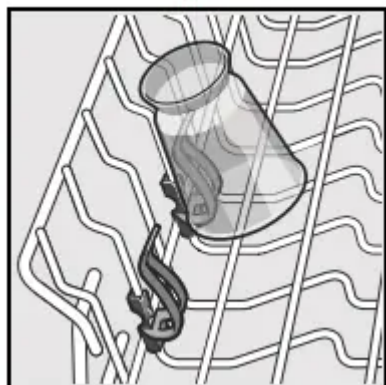

Cup Shelves

The shelf and the space underneath can be used for cups or for larger serving utensils (see Figure 8).

Figure 8

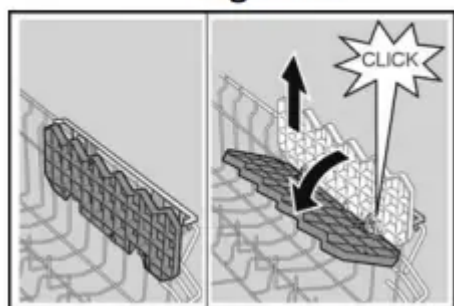

Extra Tall Item Sprinkler (model dependent)

If an item is too tall to be placed in the lower rack even with the upper rack in the raised position, remove the empty upper rack by pulling it out of the dishwasher until it stops. Pull the front of the rack upward and outward until the rollers are completely free of the roller guides.

Set the upper rack aside and push the roller guides back into the dishwasher. Insert the Extra Tall Item Sprinkler into the upper rack spray outlet and turn the sprinkler clockwise to lock into position. See Figure 9.

Figure 9

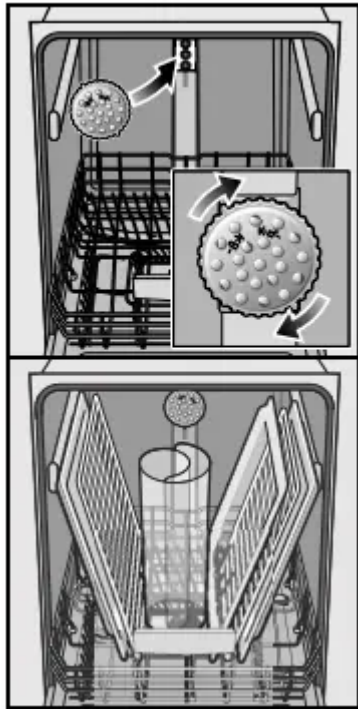

NOTE: Keep the vent on the tub's left side clear by placing tall items such as plastic cutting boards and tall baking sheets on the lower rack's right side or center.

Dishwasher Cycles and Options

Wash Cycles

NOTE: In order to save energy, it is recommended to set the "Auto Power Off" feature to "P:01" (see manual section titled "Auto Power Off").

Heavy: Best for cleaning items with baked-on food or grease. These dishes would normally require soaking.

Auto: This is the most flexible cycle. With our most complex soil sensing capability, this cycle is perfect for use with mixed loads of dishware with varying amounts of food soil.

Normal: The Normal cycle is recommended for daily, regular, or typical use to completely wash a full load of normally soiled dishes.

In order to obtain optimal performance with minimum energy consumption, it is recommended to disable all available options and settings, except "Auto Power Off" as noted at the start of this section.

NOTE 1: See footnote for additional energy test setup instructions.

Speed60®*: Cleans freshly soiled dishes with easy to remove soils. This cycle reduces cycle time while still including drying.

Half Load*: Can reduce water consumption when washing small, lightly soiled loads that fill approximately half of the dishwasher's capacity.

Clean30*: For lightly soiled items with easy to remove food soils. Reduces overall wash time.

Rinse*: If you need to pre-rinse dishes to avoid odors, let the dishwasher do the work for you! Place unrinsed dishes inside the dishwasher and select the "Rinse" cycle. Uses less water than hand rinsing and very low energy.

Wash Cycle Options

Delay Start: Allows you to delay the start time of your dishwasher in one hour increments up to 24 hours.

Half Load*: Can reduce water consumption when washing small, lightly soiled loads that fill approximately half of the dishwasher's capacity.

Sanitize*: Available only in the Heavy, Auto and Normal cycles. The sanitize LED will light when sanitation requirements are met. The technical sanitation measures may also improve the drying results.

NOTE: The dishwasher automatically defaults to Auto Wash when turned off and back on. If you used the sanitize option in your last cycle, the dishwasher will default to Auto Wash with the Sanitize option selected when you turn it on.

ExtraDry*: Used in combination with a wash cycle, the Extra Dry option raises the temperature and extends the drying time to further enhance drying results and provides a brilliant shine.

ExtraScrub*: This option increases pressure and temperature in the lower rack for intensive cleaning.

ExtraShine®*: Used in combination with a wash cycle (except Rinse), the ExtraShine® option helps dishes and glassware come out exceptionally clean with perfect shine by raising the temperature and extending the drying time.

Delicate*: Available only in the Heavy, Auto, and Normal cycles. This option's lower temperature will reduce the risk of cloudy glasses.

* model dependent

NOTE 1: The Energy Guide label was based on the Normal or Regular soil sensing cycle as follows: The unit was tested without any Rinse Aid (liquid) in the Rinse Aid chamber. A single dose of detergent was inserted into the Detergent Dispenser, with no detergent being used in the prewash. The unit was not subjected to truncated testing per the definitions in the test procedure. We recommend that dish loads such as the one in the energy certification test have the rack position set in the highest position

Operating the Dishwasher

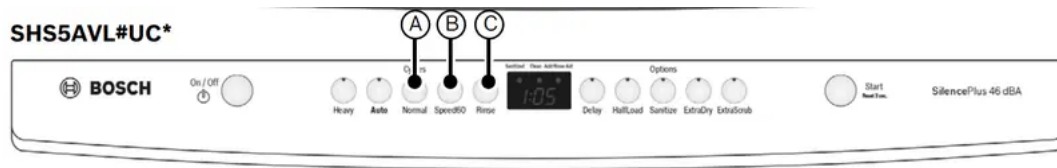

Start the Dishwasher

1. Press the [On/Off] button.
2. Select a cycle and desired options and press [Start].

NOTE: Your dishwasher is protected against unintentional operation. If the appliance door remains open for more than 4 seconds after pressing the [Start/Resume] button, the operation will be paused. Press the [Start/Resume] button again and close the appliance door.

Cancel a Cycle

1. Press and hold the [Start] button for approximately 3 seconds until the display reads "0:01".
2. Wait about 1 minute while the dishwasher drains.
3. Press the [On/Off] button.

NOTE: Your dishwasher is protected against unintentional operation. If the appliance door remains open for more than 4 seconds after pressing the [Start/Resume] button, the operation will be paused. Press the [Start/Resume] button again and close the appliance door.

Interrupt a Cycle

1. Press the [On/Off] button to turn the unit off.
2. To resume the cycle, press the [On/Off] button.

NOTE: Your dishwasher is protected against unintentional operation. If the appliance door remains open for more than 4 seconds after pressing the [Start/Resume] button, the operation will be paused. Press the [Start/Resume] button again and close the appliance door.

Setting the Amount of Rinse Aid

The amount of rinse aid dispensed can be set from "r:00" to "r:06".

To change the setting:

1. Press the [On/Off] button.
2. Hold down the "A" button (see page 15) and press [Start] until the display indicates "d:00" (x can be any number).
3. Release both buttons.
4. Press the "A" button until the display shows "r:05". NOTE: For models without a display, press

the “A” button until the LEDs for “Clean” and “Add Rinse Aid” are blinking.

5. Press the “C” button to select the desired setting.

“r:00” or 0 LEDs blinking = dispenser is OFF

“r:01” or 1 LED blinking = lowest setting

“r:02” = low setting

“r:03” or 2 LEDs blinking = medium setting

“r:04” = medium/high setting

“r:05” = high setting

“r:06” or 3 LEDs blinking = highest setting

6. Press [Start] to save the setting

Child Lock

NOTE; Only front-control models have Child Lock.

1. After starting a cycle you can activate the Child Lock.
2. Press and hold the C button until the display reads “CL” (models with display) or the “Child Lock” LED illuminates (models without display). NOTE: “CL” disappears from screen when button is released.
3. Child Lock is now active and buttons will not function, except On/Off.
4. To deactivate, press and hold the C button until the “Child Lock” LED turns off or “CL” disappears from the display

Delay Start

For models with a display, you can delay the start of the cycle in one hour increments up to 24 hours. For models without a display, you can delay the start of the cycle in three hour increments up to 9 hours.

To set delay start:

1. Press the [On/Off] button.
2. Press the [Delay] button until the display jumps to “h:01” or the corresponding LED blinks.
3. Press the [Delay] button until the delay time corresponds with your requirements. For models with a display, the display can be interpreted as follows:

h:01 = 1 hour delay

h:24 = 24 hour delay

4. Press [Start] to activate delay start.

NOTE: Your dishwasher is protected against unintentional operation. If the appliance door remains open for more than 4 seconds after pressing the [Start/Resume] button, the operation will be paused. Press the [Start/Resume] button again and close the appliance door.

To cancel delay start:

1. For models with a display, press the [Delay] button until "h:00" is indicated on the digital display. For models without a display, press the [Delay] button until no LEDs are blinking.
2. Press and hold [Start] for 3 seconds to cancel the cycle. You may now start a new cycle.

NOTE: Your dishwasher is protected against unintentional operation. If the appliance door remains open for more than 4 seconds after pressing the [Start/Resume] button, the operation will be paused. Press the [Start/Resume] button again and close the appliance door.

Cycle Completion Signal

1. Press the [On/Off] button.
2. Hold down the "A" button (see page 15) and press [Start] until the display indicates "d:00". Release both buttons.
3. Press the "A" button until the display shows "b:02" for models with a display. For models without a display, the "Clean", "Sanitized", and "Add Rinse Aid" LEDs are all blinking.
4. Press the "C" button to increase or decrease the tone. See settings below:

"b:00" or 0 LEDs blinking = Cycle Completion Signal OFF

"b:01" or 1 LED blinking = Low tone volume

"b:02" or 2 LEDs blinking = Medium tone volume

"b:03" or 3 LEDs blinking = High tone volume

5. Press [Start] to save setting

Infolight®

NOTE: Setting can only be changed for models with a display.

An LED illuminates the floor to indicate the unit is running. If the appliance is installed at eye-level, the LED is not visible.

To change the setting:

1. Press the [On/Off] button.
2. Hold down the "A" button (see page 15) and press [Start] until the display indicates "d:00".
3. Release both buttons.
4. Press the "A" button until the display shows "1:01".
5. Press the "C" button to switch between "1:01" = ON and "1:00" = OFF and press [Start] to save.

Auto Power Off

NOTE: Setting can only be changed for models with a display. For models without a display, the default setting is P:00

To save energy, the dishwasher is turned off 1 minute after the wash cycle ends. This setting can be adjusted from P:00 to P:02.

To change the setting:

1. Open the door and press the [On/Off] button.
2. Hold down the "A" button (see page 17) and press [Start] until the display indicates "d:0x" (x can be any number). Release both buttons.
3. Press the "A" button until the display indicates "P:0x".
4. Press the "C" button until the display corresponds with your requirements.

P:00 = dishwasher does not turn off automatically

P:01 = dishwasher turns off automatically after 1 minute

P:02 = dishwasher turns off automatically after 120 minutes (2 hours)

5. Press [Start] to save the setting.

Care and Maintenance

A regular inspection and maintenance of your machine will help to prevent faults. This saves time and prevents possible future problems.

Overall condition of the machine

Never use a steam cleaner to clean your dishwasher. The manufacturer is not responsible for any consequential damage. Regularly wipe the front of the appliance with a damp cloth - water and a small amount of liquid soap is adequate. Do not use sponges with a rough surface or abrasive detergents, as these could scratch the surfaces.

Stainless steel appliances: To prevent corrosion, avoid using sponge cloths or chlorine based cleaners. Use a stainless steel polish to seal and protect the surface.

Clean the outer edges of the inside door panel regularly to remove debris that may collect from normal loading. If spots begin to appear on the stainless steel, make sure the rinse agent is full and functioning properly.

Filters

The filter system consists of a coarse filter, a flat fine filter and a micro filter. The filters keep large foreign objects in the rinsing water away from the pump. Foreign objects may occasionally block the filters.

Check the filters for residue by:

- Unscrew the filter cylinder as illustrated in Figures 9-10 and take out the filter system.
- Remove any residue and clean filters under running water.
- Reinstall filter system in reverse sequence and ensure that the arrow marks are facing each other after locking it into place.

Figure 9

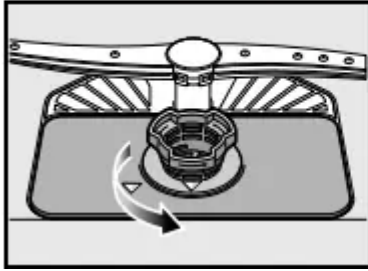
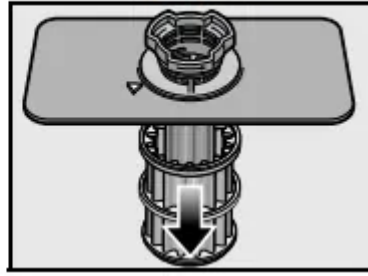

Figure 10



Spray Arms

Check spray arms for grease and limescale deposits. If you find such deposits:

- Fill detergent dispenser with detergent and start the appliance without utensils in the cycle with the highest rinsing temperature (see wash cycle information table).
- Clean the appliance with detergents/appliance cleaners which are particularly suitable for use with dishwashers.
- Unscrew the spray arms and inspect as shown in Figure 11.

Figure 11

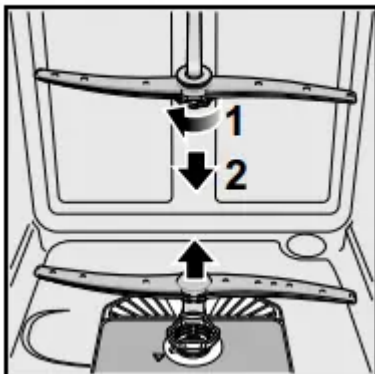

Drain Pump

Large food remnants in the rinsing water not retained by the filters may block the drain pump. The rinsing water does not get pumped out and covers the filters.

In this case:

- Disconnect the appliance from the power supply.
- Remove the filters.
- Scoop out standing water - use a sponge if necessary.
- Using a spoon, pry off the pump cover (see Figures 12-13) until it clicks, then grip the cover and pull upward until it resists and then pull forward.
- Check inner compartment and remove any foreign objects.
- Place cover in the original position, press down and engage.
- Reinstall filters.

Figure 12

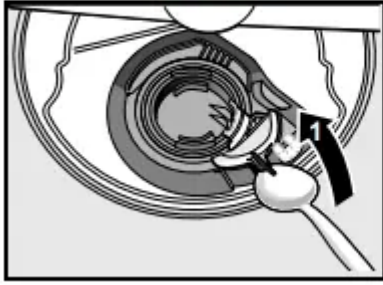
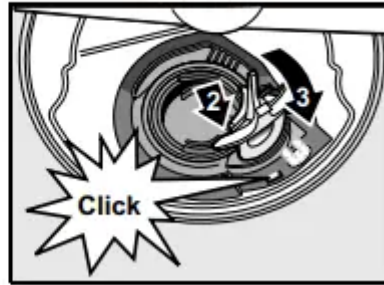

Figure 13



NOTICE

Preparing your Dishwasher for Vacation

Before leaving for vacation during warmer weather, besides turning off the main valve, also turn off water supply at the nearest point to the dishwasher. During colder weather, please follow the instructions for winterizing your unit below.

NOTICE

Winterizing your Dishwasher

If your dishwasher will be unused for an extended period of time in a location that experiences freezing temperatures (holiday home or through a vacation period), have your dishwasher winterized by a professional servicer.

Troubleshooting Guide

Dishwashers may occasionally exhibit problems that are unrelated to a malfunction of the dishwasher itself. The following information may help you with a dishwasher problem without involving a repair professional.

Problem	Cause	Action
Cycle does not resume after door is opened and closed during cycle.	<ol style="list-style-type: none"> 1. Door is opened longer than 4 seconds after a cycle has started. 	<ol style="list-style-type: none"> 1. Press [START/RESUME] button.
Self-latching door not closing properly	<ol style="list-style-type: none"> 1. Self-latching feature will not work properly if dishwasher is not installed correctly. 	<ol style="list-style-type: none"> 1. Ensure the alignment of the door is accurate and level.
Dishwasher does not start	<ol style="list-style-type: none"> 1. Door may not be properly latched. 2. Unit may not be turned on. 3. Unit not reset or previous cycle not completed. 4. Delay start engaged. 5. Interruption of electrical power supply to dishwasher or blown fuse. 6. The door may have been closed without first selecting a cycle. 7. Water supply may not be turned on. 	<ol style="list-style-type: none"> 1. Shut the door completely. 2. Press the main power switch. 3. To reset, refer to “Operating Instructions” manual. 4. To reset, refer to “Delay Start” section. 5. Check circuit breaker. 6. Select a cycle and press start button. 7. Check and turn on water supply.
Dishwasher beeping (end of cycle signal)	<ol style="list-style-type: none"> 1. Default factory settings alert the customer that the cycle is complete by beeping. This feature can be deactivated if so desired. 2. Water connection is lost. 	<ol style="list-style-type: none"> 1. To adjust the volume or deactivate the beeping, refer to “Completion Signal” section in the manual. 2. Check and turn on water supply.
Display does not illuminate or console lights are not on	<ol style="list-style-type: none"> 1. A fuse may have been blown or circuit breaker tripped. 2. Door not closed or latched. 	<ol style="list-style-type: none"> 1. Check the fuse or circuit breaker. Replace the fuse or reset the breaker if necessary. 2. Ensure door is properly latched.



<p>Dishwasher seems to run a long time</p>	<ol style="list-style-type: none"> 1. Incoming water is not warm enough. 2. Cycle time can vary due to soil and water conditions. 3. Rinse aid dispenser is empty. 4. Dishwasher connected to cold water supply. <p><i>NOTE: Refer to "Wash Cycle Information" section in this manual for typical cycle lengths.</i></p>	<ol style="list-style-type: none"> 1. Before starting a cycle, run closest to the dishwasher. 2. Sensors in the dishwasher cycle time to ensure a good wash detected. 3. Add rinse aid. 4. Verify dishwasher is connected plumbing.
<p>Dishes are not getting clean enough</p>	<ol style="list-style-type: none"> 1. Spray arm movement obstructed. 2. Spray arm nozzles clogged. 3. Improper use of detergents. 4. Filters could be clogged. 5. Dishes are nested or loaded too close together. 6. Selected wash cycle is not suitable for food soil conditions. 	<ol style="list-style-type: none"> 1. Ensure that spray arm moving rotating spray arms before start 2. Remove the spray arms and "Care and Maintenance" section of the manual. 3. Increase or decrease detergent hardness (refer to Table 1). 4. Clean the filters according to section of the manual. 5. Rearrange load such that water in the dishwasher - see "Loading the Dishwasher" section of the manual. 6. Refer to "Wash Cycle Information" section of the manual.
<p>Dishes are not getting dry enough</p>	<ol style="list-style-type: none"> 1. Rinse aid dispenser is empty. 2. Improper loading of dishes. 3. Selected cycle does not include drying. <p><i>NOTE: Plastic or Teflon do not typically dry as well as other items due to their inherent properties.</i></p>	<ol style="list-style-type: none"> 1. Add rinse aid - the use of rinse aid 2. Rearrange load to ensure it is "Loading the Dishwasher" section of the manual. 3. Rinse and Hold setting does not improve drying performance. <p><i>NOTE: Sanitize option and Intense Wash cycle can improve drying performance.</i></p>
<p>Odor</p> <p><i>NOTE: Water testing is done in the factory. Occasionally water may still appear in the</i></p>	<ol style="list-style-type: none"> 1. Food debris is present at the bottom of the dishwasher. 2. Food particles are present near the door seal. 3. Dishes left in unit too long before running a cycle. 4. Residual water is present at the bottom of the dishwasher. 	<ol style="list-style-type: none"> 1. Remove the filters and clean them according to "Care and Maintenance" section of the manual. 2. Refer to "Care and Maintenance" section of the manual. 3. Run a Rinse cycle if you do not wash the dishes.



<p><i>dishwasher at purchase which may create an odor.</i></p>	<p>5. Drain hose is obstructed.</p>	<p>4. Ensure the unit has completed cycle.</p> <p>5. Remove any obstructions from drain hose. If necessary, call a qualified technician or qualified personnel.</p> <p><i>NOTE: If odor still persists, run a hot water flush and interrupt the cycle. Add a cup of distilled white vinegar solution to the rinse aid compartment and finish the cycle.</i></p>
<p>Dishwasher not filling with water</p>	<p>1. Restriction in the water supply system. 2. Previous wash cycle was not completed. 3. Delay start is active.</p>	<p>1. Ensure that the water supply valve (located under kitchen sink) is open and the water supply line has no kinks or clogs.</p> <p>2. Refer to the “Operating the Dishwasher” section of the manual.</p> <p>3. Cancel the delay start or wait for the cycle to complete.</p>



Water leaks	<ol style="list-style-type: none"> 1. Suds. 2. Door seal could be pulled away from track. 3. Condensation vent is blocked. 4. Improper installation. 	<ol style="list-style-type: none"> 1. Wrong type of detergent results in sudsing. Use only dishwasher detergents. Add one tablespoon of vegetable oil to the detergent dispenser in the dishwasher and run the desired cycle. 2. Ensure the door seal is in the track. 3. Ensure that condensation vent is not blocked. 4. Have proper installation verified by a professional (water supply, drain system, leveling).
Tub stains	<ol style="list-style-type: none"> 1. Stains on the dishwasher interior are due to water hardness. 2. Silverware in contact with tub. 	<ol style="list-style-type: none"> 1. Concentrated lemon juice can remove hard water stains. Run a Normal cycle, interrupt the cycle and then place a solution of concentrated lemon on the tub. This can be done periodically to keep the tub clean. 2. Ensure that silverware does not touch the tub while running a cycle.
Streaks on glassware or residue on the dishes	<ol style="list-style-type: none"> 1. Incorrect rinse agent setting. 	<ol style="list-style-type: none"> 1. Depending on the hardness of the water, adjust the rinse agent dispenser. Refer to “Dishwasher Settings” in the manual.
Fascia panel discolored or marked	<ol style="list-style-type: none"> 1. Abrasive cleaner used. 	<ol style="list-style-type: none"> 1. Use mild detergents with soft cloths.
Noise during wash cycle	<ol style="list-style-type: none"> 1. Dishes may not be arranged properly. 	<ol style="list-style-type: none"> 1. Water circulation sound is normal. If items are banging into each other, refer to the “Loading the Dishwasher” section in the manual for optimal arrangement.
Detergent dispenser cover will not shut	<ol style="list-style-type: none"> 1. Improper operation of detergent cover. 2. Previous cycle has not finished and should be interrupted or cancelled. 	<ol style="list-style-type: none"> 1. Refer to “Detergent” section of the manual for instructions on opening and closing the detergent dispenser. 2. Refer to the “Operating the Dishwasher” section of the manual.



Unable to select desired cycle	1. Previous cycle has not finished.	1. Refer to the “Operating the Dis manual.
--------------------------------	-------------------------------------	--

Warning

This content is compiled from multiple sources and is provided for reference purposes only. It may not be complete or fully applicable to all situations. If you are unable to resolve your issue, please contact the product manufacturer or an authorized service provider for official support.

