

## Introducing your new range

MODEL NX58\*751\*\*\*

### Overview

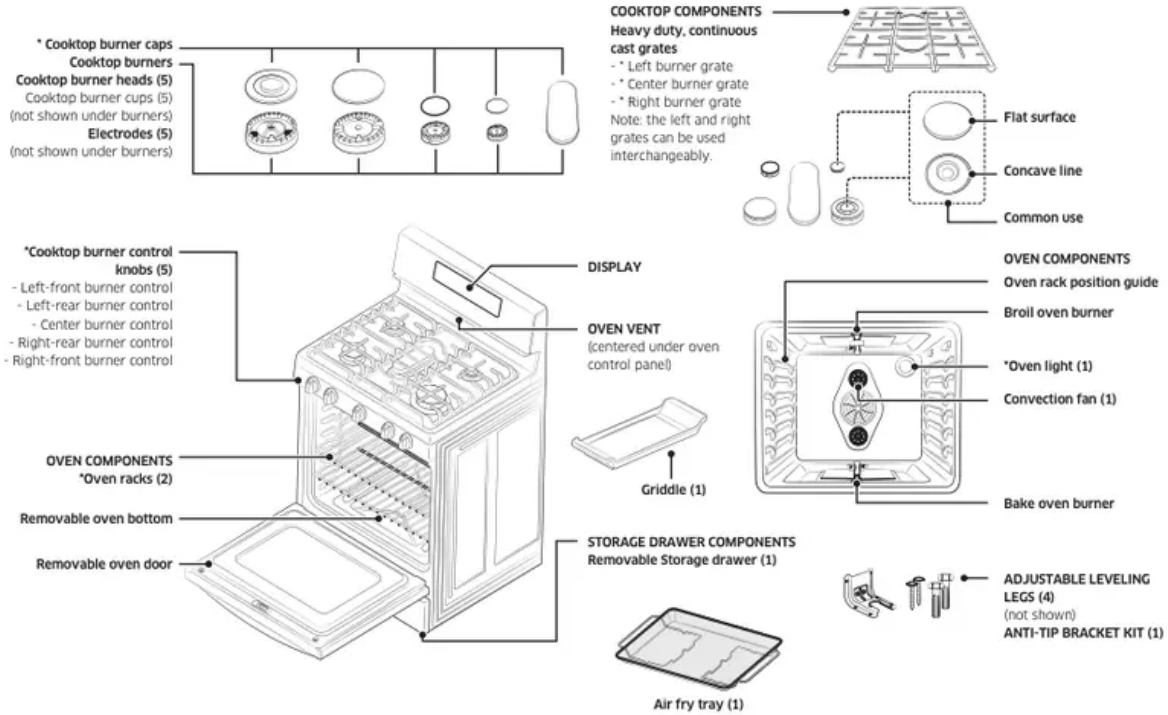

## Surface cooking

### WARNING

BEFORE USING THE SURFACE BURNERS, make sure to follow all the safety warnings and precautions listed on page 6. Failure to do so could result in product damage, personal injury, and/or death.

### Lighting a gas surface burner

Make sure all surface burners are positioned and assembled properly.

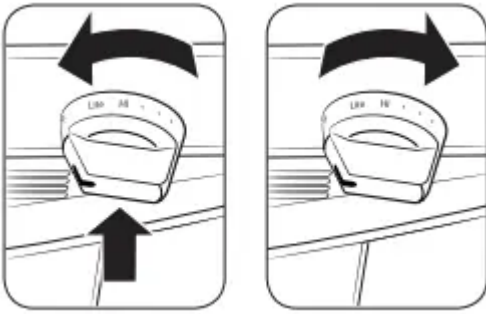

1. Push in and turn the control knob to the LITE position. You will hear a “clicking” sound indicating the electronic ignition system is working properly.
2. After the surface burner lights, turn the control knob to adjust the power setting of the surface burner and turn off the electronic ignition system.

**NOTE** We highly recommend using the left rear side burner for simmering tomato sauce and right rear side burner for melting chocolate.

### **Manually lighting a gas surface burner**

If a power failure occurs, the surface burners can still be lit manually.

**NOTE** Use extreme caution when manually lighting a surface burner.

1. Hold a long gas grill lighter to the surface burner you want to light.
2. Push in and turn the control knob for that burner to the LITE position.
3. After the burner has lit, set the control knob and the burner to the desired setting.

### **Flame size selection**

**WARNING** Flames larger than the bottom of the cookware will not result in faster heating, but could result in a fire hazard and/or personal injury.

The flames on the burners should always stay under the cookware. The flames should never extend beyond the bottom surface and/or up the sides of the cookware.

Always watch the flames when adjusting the heat setting with the control knob(s). The flames should always match the size of the cookware being used.

## Gas surface burners and control knobs

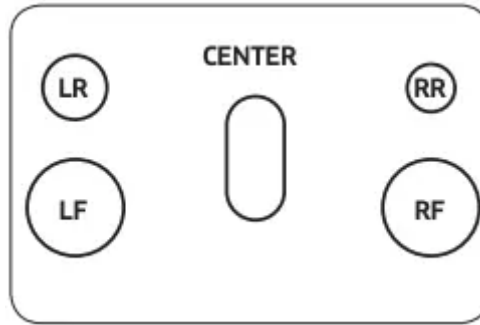

Your gas range cooktop has five gas burners. All sealed cooktop burners use an open-port design which provides easy assembly and accurate and dependable operation. The different burner sizes ensure you have the proper heat source for the desired cooking job.

The right rear side burner provides precise cooking performance for delicate foods and foods that require low heat for long cooking times. The right rear side burner lets you use the LO setting for a very low simmer setting.

The left rear side and center round burners are general-purpose burners that can be used for most cooking. The HI to LO settings provide a wide range of cooking temperatures to meet your cooking needs.

The right and left front side burners provide maximum output. These burners can also be used as general-purpose burners, but they are designed to provide quick heat to large cookware. The right and left front side burners spread out the heat with a larger circle of flames. This provides better heat distribution for larger cookware (12"/30.5 cm) or larger pots and pans.

BURNER POSITION	FUNCTION	TYPE OF FOOD
RIGHT FRONT (RF)	Quick heating	Boiling Food
RIGHT REAR (RR)	Low simmering	Chocolate, Casseroles, Sauces
CENTER	Griddle Cooking	Pancakes, Hamburgers, Fried Eggs, Hot Sandwiches
LEFT FRONT (LF)	Quick heating	Boiling Food
LEFT REAR (LR)	General heating Low simmering	General Food Tomato Sauce*, Casseroles

### NOTE

\* Tomato sauce needs to be stirred during the low simmering.

The center oval burner can also be used for large pots and pans, but is designed to be used with the center burner grate and/or the center griddle accessory (if equipped).

The oval burner spreads out the heat more evenly over the large center cooking area.

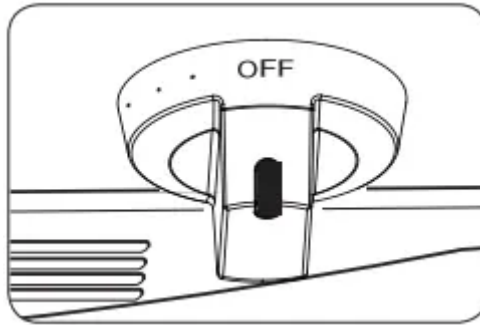

Each surface burner has a control knob with settings from HI to LO. They also have a LITE setting that is only used to light the flame. The electronic ignition system sparks when the control knob is in the LITE position. The surface burner indicator next to the control knob shows which burner the knob controls.

### Cookware usage

Using the correct cookware can prevent many problems, such as uneven cooking or extended cooking times. Using the proper pans will reduce cooking times and cook food more evenly. Look for the following pan characteristics:

- Flat bottom and straight sides.
- Tight-fitting lid.
- Weight of handle does not tilt pan.
- Pan is well-balanced.
- Pan size matches the amount of food being prepared and the size of the surface burner.
- Made of material that conducts heat well.
- The pot/pan diameter matches the surface burner flame diameter.

What your cookware is made of determines how evenly and quickly heat is transferred from the surface burner to the pan bottom.

- **ALUMINUM:** Excellent heat conductor. Some types of food will cause the aluminum to darken. (Anodized aluminum cookware resists staining and pitting.)
- **COPPER:** Excellent heat conductor, but discolors easily.
- **STAINLESS STEEL:** Slow heat conductor with uneven cooking results. Is durable, easy to clean, and resists staining.
- **CAST-IRON:** A poor conductor, but retains heat very well. Cooks evenly once cooking temperature is reached.
- **ENAMELWARE:** Heating characteristics will vary depending on base material.

- **GLASS:** Slow heat conductor. Glass cookware is designed for two usages—top-of-range cooking or oven use. Only use cookware where it is designated to be used.

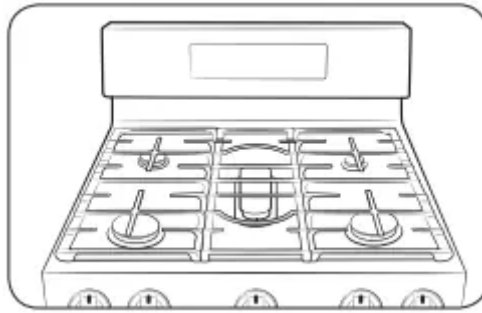

**NOTE** Do not place a small pan or pot with a bottom diameter of about 6" or less on the center grate. It is likely that the pan or pot will tip over. We strongly recommend you place small-sized pots or pans on the rear of either side grate.

### Center burner grate

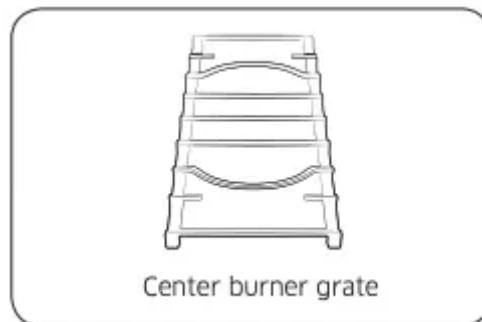

Samsung gas ranges come with a center burner grate. This grate fits over the center oval burner. The center burner grate should not be placed over any other burners and no other center stovetop grates should be used with this range.

### Using the griddle

The non-fixed coated griddle provides an extra-large cooking surface for meats, pancakes, or other food usually prepared in a frying pan or skillet.

**How to Place the Griddle:** The griddle can only be used with the center burner. The griddle must be properly placed on the center grate as shown in the figure below.

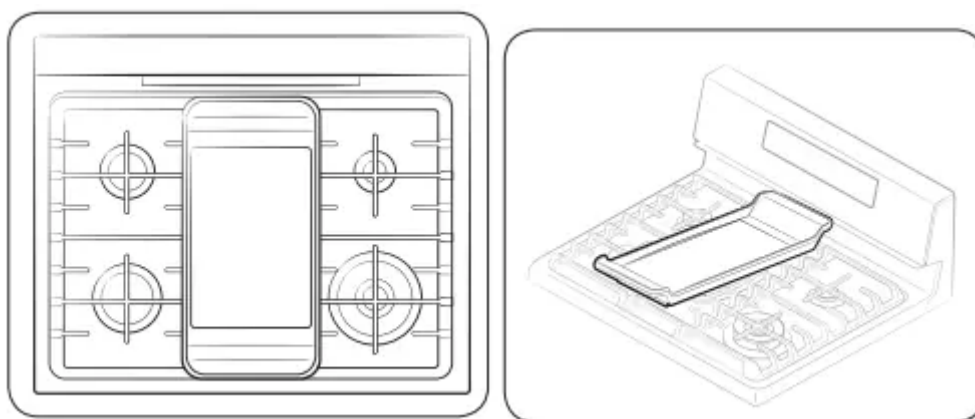

**WARNING** DO NOT remove the center grate when using the griddle.

**How to cook:** Preheat the griddle according to the guide below, and then adjust for the cooking conditions.

Type of Food	Preheat Time	Preheat Condition	Cook Condition
Pancakes	5 min	5 (MED-HI)	4 (MED)
Hamburgers	5 min	7 (HI)	5 (MED-HI)
Fried Eggs	5 min	7 (HI)	5 (MED-LO)
Bacon	-	None	4 (MED)
Breakfast Sausages	5 min	7 (HI)	5 (MED)
Grilled Cheese Sandwich	4 min	7 (HI)	6 (MED-HI)

### CAUTION

- DO NOT remove the griddle until the cooktop grates, surfaces, and griddle are completely cooled.
- The griddle on the cooktop may become very hot when you use the cooktop, oven, or broil systems. Always use oven gloves when placing or removing the griddle.

### NOTE

- Carefully put the griddle on the center grate.
- Griddle settings may need to be adjusted if the griddle is used for an extended time.
- Your griddle will discolor over time as it becomes seasoned with use.
- After use, return the griddle to storage only after it has cooled.

# Operating the oven

## Important Note:

- DO NOT overheat the griddle. This can damage the non-fixed coating.
- DO NOT use metal utensils that can damage the griddle surface. Do not use the griddle as a cutting board.
- DO NOT place or store items on the griddle.
- DO NOT turn the griddle over and use the underside for cooking. Use the top side of the griddle only.
- DO NOT use the griddle for any purpose other than cooking.
- Avoid cooking extremely greasy foods. Grease spill overs can occur.
- The griddle can become hot when surrounding burners are in use.

## Oven control panels and displays

### MODEL NX58\*751\*\*\*

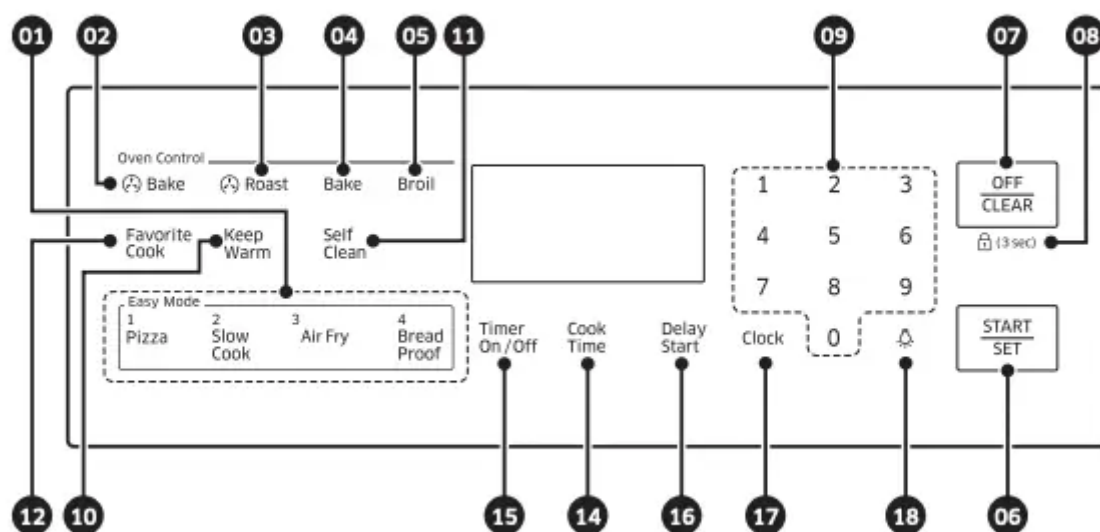

**NOTE** All oven operations are controlled with electronic touch pads. Use the following pads to program and operate all oven cooking, cleaning, and timing functions. All programmed settings and cooking statuses will show on the digital display.

## Special feature, oven, and time controls

- 01 EASY COOK: Press to recall the Easy cook recipe setting of the oven.
- 02 CONVECTION BAKE (🌀 Bake): Activates the convection bake function. Use this function to cook large amounts of baked goods on multiple shelves at the same time.

- 03 CONVECTION ROAST  (Roast): Activates the convection roast function. Use this function to cook large cuts of meat.
- 04 BAKE: Touch this pad to activate the Bake function. Evenly cooks food using the bottom oven burner.
- 05 BROIL: Activates the Broil function. Cooks foods using the top oven burner only.
- 06 START/SET: Touch this pad to start the oven cooking, cleaning, and/or timing functions.
- 07 OFF/CLEAR: Press to cancel all oven operations except the clock and timer.
- 08 HOLD 3 SEC: Deactivates the control panel touch pads to prevent the oven from accidentally being turned on. It also locks the oven door to prevent accidental tipping of the range. Touch pads will not work and the oven door will stay locked until this function is turned off.
- 09 NUMBER PADS: Touch these pads to set the desired times, temperatures, and preset oven functions.
- 10 KEEP WARM: Touch this pad to keep cooked foods warm after cooking. This lowers the oven temperature and maintains it at 150 °F to 200 °F (66 °C to 93 °C).
- 11 SELF CLEAN: Activates the self-cleaning oven function. Uses very high heat to burn off internal oven soilage.
- 12 FAVORITE COOK: Activates the favorite cook feature. This feature lets you preprogram up to three frequently used cooking cycles so they can be set and started with the touch of a button.
- 13 WARMING DRAWER (MODEL NX58\*565\*\*\*): Touch this pad to activate the warming drawer. An electric heating element under the drawer uses three settings to keep cooked foods warm.
- 14 COOKING TIME: Touch this pad, and then the desired amount of time you want your food to cook. The oven will automatically shut off when the time has elapsed.
- 15 TIMER ON/OFF: Touch to select the timer feature. Activates a kitchen timer for the desired amount of time.
- 16 DELAY START: Allows you to set the oven to start and stop automatically. Use with Bake, Convection Bake, Convection Roast, Cook Time, or Self Clean functions.
- 17 CLOCK: Allows you to set the clock.
- 18 OVEN LIGHT: Touch this pad to turn the oven light on or off.

## Minimum and maximum settings

All the features listed in the following chart have minimum and maximum temperature or time settings.

FEATURE	MINIMUM SETTING	MAXIMUM SETTING
BAKE	150 °F (66 °C)	550 °F (288 °C)
BROIL	Lo	Hi
SELF-CLEAN	2 hours	4 hours
CONVECTION BAKE (🌀 Bake)	150 °F (66 °C)	550 °F (288 °C)
CONVECTION ROAST (🌀 Roast)	150 °F (66 °C)	550 °F (288 °C)
AIR FRY	350 °F (177 °C)	500 °F (260 °C)
KEEP WARM	-	3 hours
WARMING DRAWER *	-	3 hours
BREAD PROOF	-	12 hours

## Setting the clock

The clock must be set to the correct time of day for the automatic oven timing functions to work properly. The clock can be adjusted to show a 12-hour or 24-hour display. The 12-hour display is the default setting. The time of day cannot be changed during a timed cooking, delayed start, selfcleaning, or Sabbath function operation.

### How to set the clock

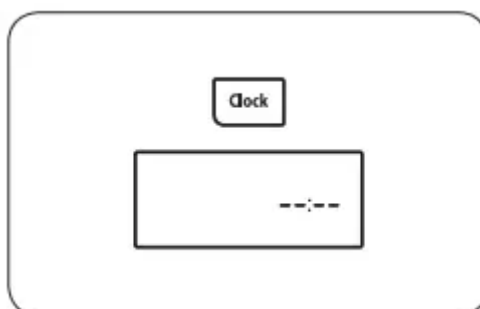

1. Press the Clock pad.

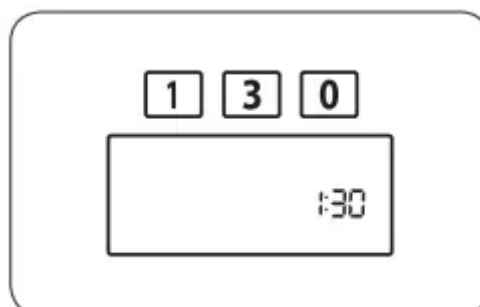

2. Enter the current time in hours and minutes using the number pads (e.g., 1, 3, 0). The display will show the time of day, and the Start indicator will blink.

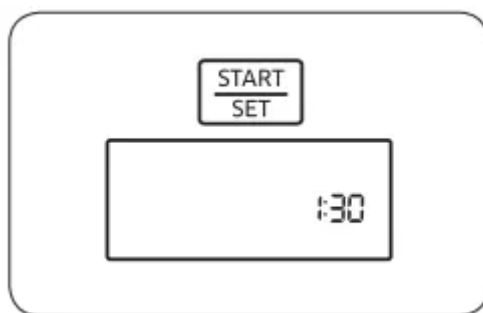

3. Press the START/SET pad to set and start the clock. The display will show the time of day, and the Start indicator will turn off.

**How to change between a 12-hour and 24-hour display**

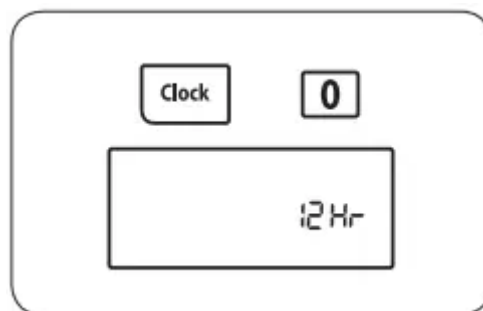

1. Press and hold the Clock and 0 pads for 3 seconds. The display will show the present mode (e.g., 12Hr).

**NOTE** If one pad is pressed before the other, -- -- will appear in the display. Press the OFF/CLEAR pad and start again.

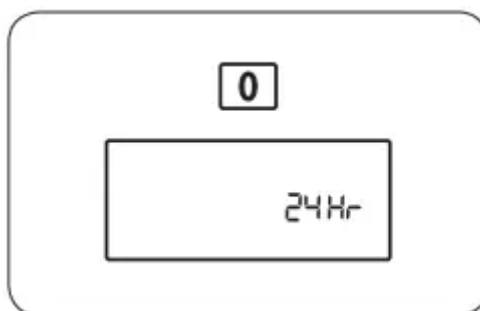

2. Press the 0 pad to toggle between the 12-hour and 24-hour display setting. 12Hr or 24Hr will show in the display depending on your selection.

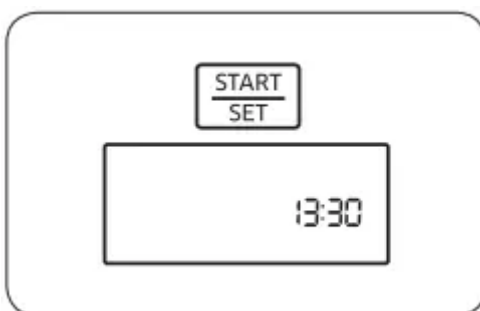

3. Press the START/SET pad to change the clock display mode.

### Setting the timer on/off

The timer counts down time remaining and beeps when the set time has elapsed. It does not start or stop cooking functions. You can use the kitchen timer at the same time as any other range functions and set it for any amount of time between 1 minute and 9 hours and 99 minutes.

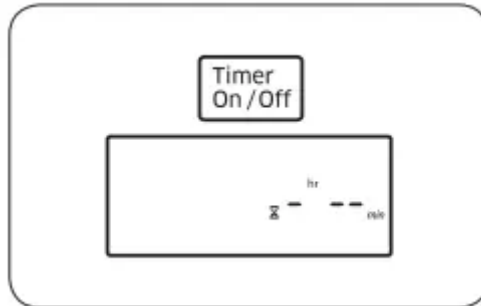

1. Press the Timer On/Off pad once for hours/minutes and twice for seconds. Press the pad three times to turn off the kitchen timer or cancel it before it starts to run. The display will show Timer, and -hr --min will blink in the display. (Hr and min characters are not displayed on the NX58\*560\*\*\*, NX58\*751\*\*\*)

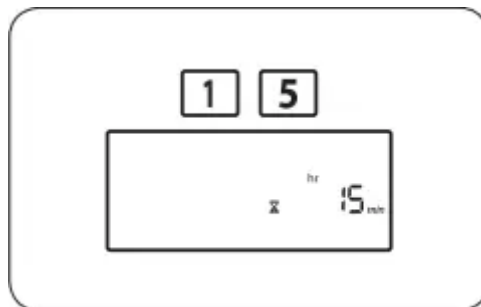

2. Press the number pads to enter the amount of time you want in minutes, hours and minutes, or seconds (e.g., 1, 5). The set time will show in the display.

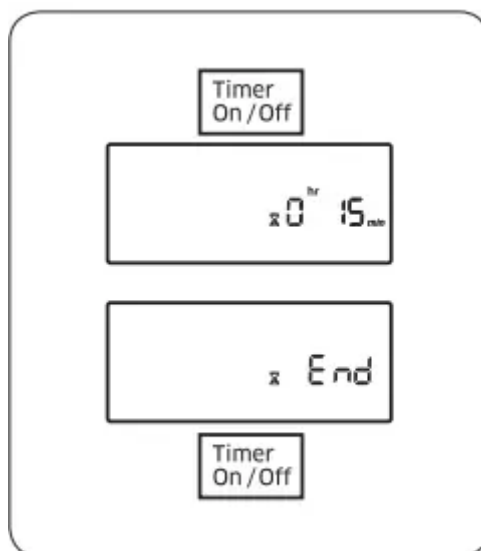

3. Press the Timer On/Off pad to start the timer. The display will show the remaining time. When time has elapsed, the oven will beep and the display will show End until you press the Timer On/Off pad. After the pad is pressed, the display will go back to showing the time of day. You can cancel the timer at any time by pressing the Timer On/Off pad.

### Positioning the oven racks

The oven racks are removable and can be positioned in any of the seven oven rack positions. Each oven rack has a built-in stop to prevent it from accidentally being pulled completely out. Proper positioning of the oven racks will provide the best cooking results. The diagram to the right shows the rack positions.

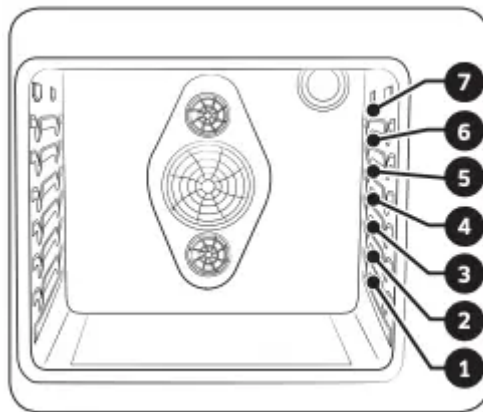

### CAUTION

- Do not cover an oven rack with aluminum foil. This will disturb the heat circulation, resulting in poor baking.
- Do not place aluminum foil on the oven bottom. It can damage the surface of the oven bottom.
- Arrange the oven racks only when the oven is cool.
- When placing an oven rack in the topmost rack position (position 7), make sure the rack is stably situated on the embossed stop.

### Oven rack positions

TYPE OF FOOD	RACK POSITION
Hamburgers and steaks	6 or 7
Toasts	5 or 6
Biscuits, muffins, brownies, cookies	4
Bundt or pound cakes	3
Angel food cake, pies	2
Roasts (small or large), ham, turkeys	1 or 2

## Baking layer cakes

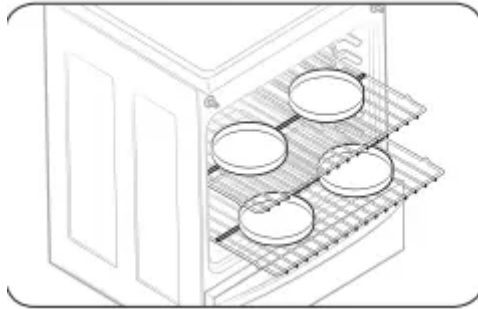

- Centering the baking pans in the oven will produce better cooking results.
- When baking multiple items, make sure to leave a 1 to 1.5" (2.5 to 3.8 cm) space around each item.
- When baking on multiple racks, place the oven racks in positions 2 and 5.
- When convection baking on multiple racks, place the oven racks in positions 2 and 5.
- Place two pans in the rear of the top rack and the other two pans in the front of the bottom rack.

**NOTE** Proper positioning of food items in the oven will help you achieve the best cooking results.

### To remove an oven rack:

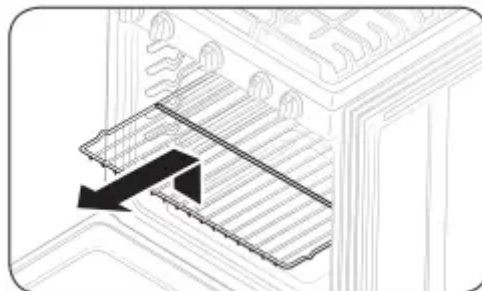

1. Pull the rack straight out until it stops.
2. Lift the front of the oven rack, and then pull to remove it from the oven.

### To replace an oven rack:

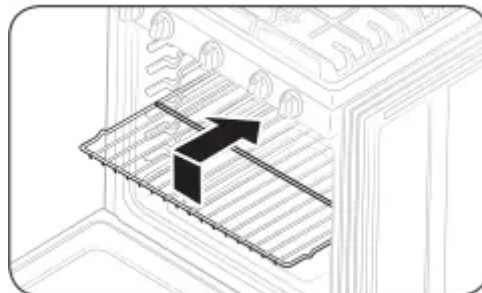

1. Place the back edge of the rack on the desired rack supports.
2. Lift the front of the rack, and then slide it into the oven.

## Oven vent



The oven vent is located under the oven control panel. Do not block or place items in front of the oven vent. Proper air circulation prevents oven burner combustion problems and ensures good cooking results. Since the vent and area around the vent can become hot, use care when placing items near the oven vent. Hot steam could heat or melt items placed in front of the oven vent.

## Oven light



The oven has a light that is located on the rear oven wall in the upper right-rear corner. The light can be turned on or off by touching the Oven Light pad on the oven control panel. The oven light allows you to check cooking progress without opening the oven door. Always use a 40-watt appliance bulb when replacing the oven light. See page 67 for light-changing instructions.

## Baking

The Bake function lets you program the oven to bake at any temperature between 150 °F (66 °C) and 550 °F (288 °C).

### How to set the oven temperature



1. Position the oven rack in the desired location.
2. Press the Bake pad. The oven will beep every time a pad is pressed. The default temperature, 350°, and the Start indicator will blink on the display. If the default temperature is the desired cooking temperature, skip to step 4.

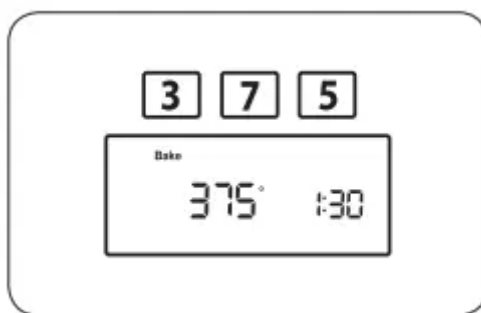

3. Press the number pads to enter the desired cooking temperature (for example, 3, 7, 5). The selected cooking temperature and the Start indicator will blink on the display.

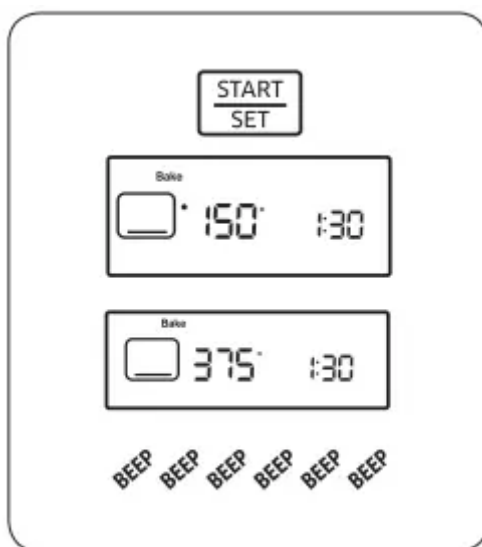

Press the START/SET pad. The oven will automatically light and start preheating. The display will show a blinking “•”, along with 150°, Bake, and the bake element icon, until the oven reaches 150°. Then, the display will just show the actual oven temperature. When the oven reaches the desired baking temperature, it will beep 6 times.

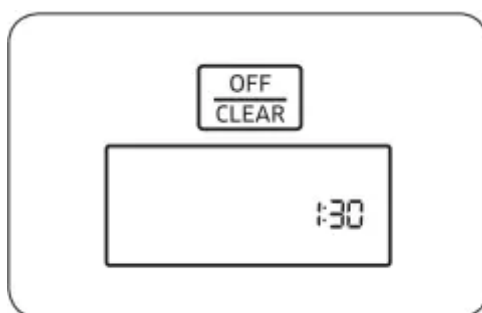

4. Place the food in the oven, and then close the oven door. Preheating is very important for good baking results.

5. When baking is complete, remove the item(s) from the oven, close the oven door, and then press the OFF/CLEAR pad. The oven will shut off, and the display will show the time of day.

To change a programmed baking temperature, press the Bake pad, enter the new baking temperature, and then press the START/SET pad. If the oven temperature is higher than the new

setting, the oven will beep 6 times, then show the new setting. The oven will complete cooking at the new temperature.

**If your baking results are not what you are used to, the preset oven cooking temperature can be adjusted  $\pm 30$  °F ( $\pm 15$  °C) as follows:**

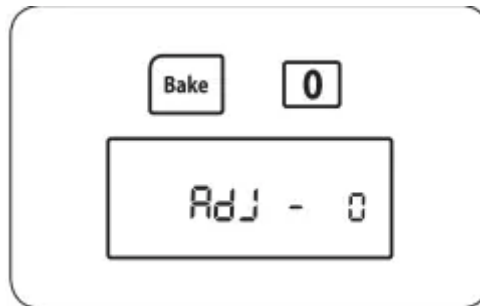

1. Press and hold the Bake and 0 pads for 3 seconds. The display will show AdJ and 0.

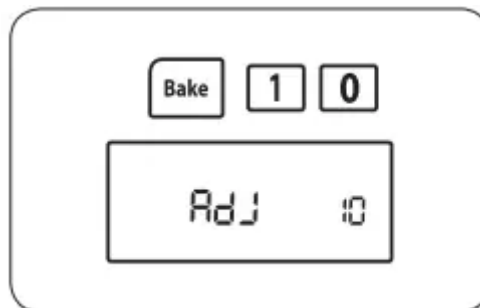

2. Press the Bake pad to toggle between + or – temperature adjustments.

3. Press the number pads to enter the desired temperature adjustment (for example, 1, 0). The display will show AdJ and 10.

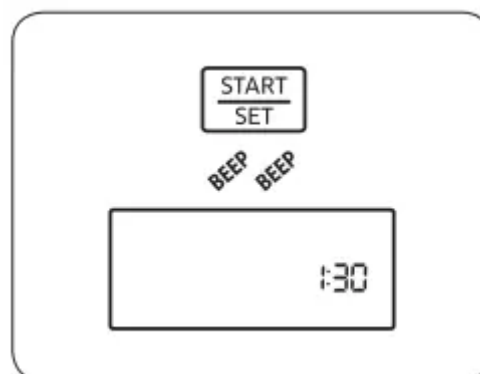

4. Press the START/SET pad. The oven will beep twice, and the display will show the time of day. The next time you bake, the oven will use the new temperature setting.

**NOTE** This adjustment will not affect the broiling or the self-cleaning temperatures. The adjustment will be retained in memory after a power failure.

## Convection baking and roasting

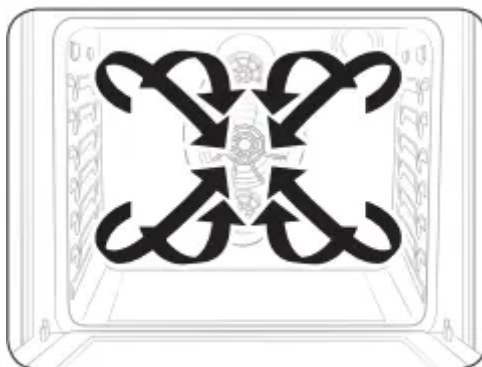

The Convection Bake function lets you program the oven to bake at any temperature between 150 °F (66 °C) and 550 °F (288 °C). The Convection Roast function lets you program the oven to roast at any temperature between 150 °F (66 °C) and 550 °F (288 °C). The convection fan in the back of the oven cavity circulates the hot air evenly throughout the oven cavity. As a result, foods are evenly cooked and browned in less time than with regular heat.

### Convection baking



- Ideal for foods being cooked on multiple racks.
- Good for large quantities of baked foods.
- Provides good results with cookies, biscuits, brownies, cupcakes, cream puffs, sweet rolls, angel food cake, and bread.
- Cookies have best cooking results when cooked on flat cookie sheets.
- When convection baking on a single rack, place the oven rack in position 3 or 4. When convection baking on multiple racks, place the oven racks in position 2 and 5.

**NOTE** The oven automatically adjusts the temperature for convection baking with the Convection Auto Conversion feature. See page 57 for details.

### Convection roasting



- Good for larger tender cuts of meat, uncovered.
- Place a broil pan and grid under the meat or poultry during convection roast for best results. The pan catches grease spills and the grid prevents grease spatters.

Meat and poultry are browned on all sides as if they were cooked on a rotisserie. Heated air will be circulated over, under, and around the food being roasted. The heated air seals in juices quickly for a moist and tender interior while creating a rich, golden-brown exterior. See the Convection roasting guide on page 41 for recommended cooking times and temperatures.

#### How to set the oven for convection baking or roasting

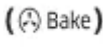
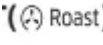

1. Position the oven rack in the desired location. 2. Press the Convection Bake  or Convection Roast  pad. The oven will beep every time a pad is pressed. The default temperature, 350°, will blink on the display. If the default temperature is the desired cooking temperature, skip to step 4.

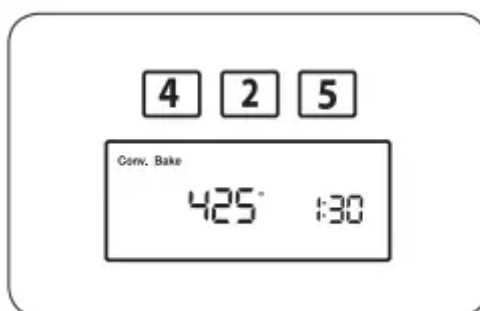

3. Press the number pads to enter the desired cooking temperature (for example, 4, 2, 5). The selected cooking temperature will blink on the display.

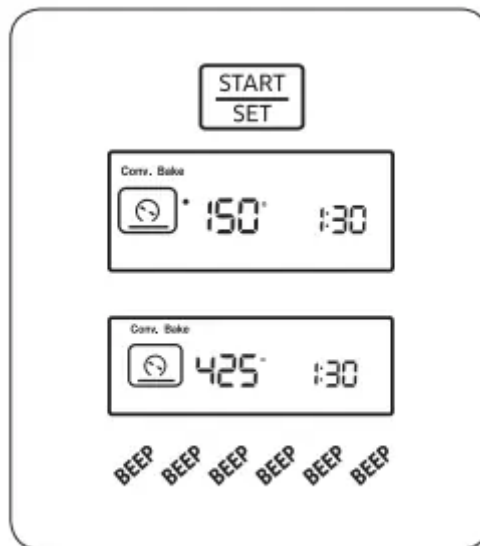

Press the START/SET pad. The oven will automatically light and start preheating. The display will show a blinking “•”, along with 150°, Conv. Bake (🌀 Bake), and the convection bake element and fan icons, until the oven reaches 150°. Then, the display will just show the actual oven temperature. When the oven reaches the desired baking or roasting temperature, it will beep 6 times.

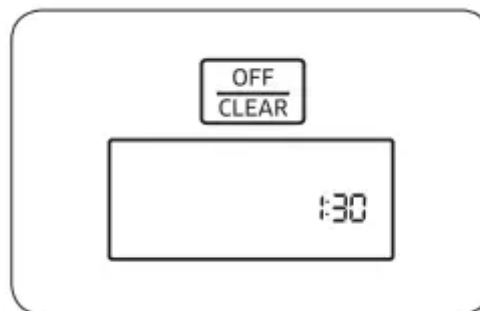

4. Place the food in the oven, and then close the oven door. Preheating is very important for good baking results. All roasting should be done on a broil pan and grid.

5. When baking or roasting is complete, remove the item(s) from the oven, close the oven door, and press the OFF/CLEAR pad. The oven will shut off, and the display will show the time of day.

To change a programmed baking or roasting temperature, press the Convection Bake (🌀 Bake) or Convection Roast (🌀 Roast) pad, enter the new cooking temperature, and then press the START/SET pad. If the oven temperature is above the new setting, the oven will beep 6 times, then show the new setting. The oven will complete cooking at the new temperature.

### Convection roasting guide

The size, weight, thickness, roasting temperature setting, and your preference of doneness will affect the roasting time. The following guide is based on foods starting at refrigerator temperature

Food		Minutes Per Pound	Oven Temperature	Internal Temperature	
Beef	Rib Roast (3 to 5 lb)	Medium	28-33	350 °F (177 °C)	160 °F (71 °C)
		Well Done	30-38	350 °F (177 °C)	170 °F (77 °C)
	Tenderloin Roast (2 to 3 lb)	Medium	35-45	350 °F (177 °C)	160 °F (71 °C)
		Well Done	45-55	350 °F (177 °C)	170 °F (77 °C)
Pork	Roast (Bone-in or Boneless) (3 to 5 lb)		22-28	350 °F (177 °C)	170 °F (77 °C)
	Chops (0.5- to 1" thick)	2 chops	30-40 total	350 °F (177 °C)	170 °F (77 °C)
		4 chops	40-50 total	350 °F (177 °C)	170 °F (77 °C)
		6 chops	45-55 total	350 °F (177 °C)	170 °F (77 °C)

Food		Minutes Per Pound	Oven Temperature	Internal Temperature	
Poultry	Chicken, Whole (2.5 to 3.5 lb)	26-30	375 °F (191 °C)	180 °F (82 °C)	
	Turkey, Whole (Unstuffed *) (10 to 16 lb)	10-16	325 °F (163 °C)	180 °F (82 °C)	
	Turkey, Whole (Unstuffed *) (18 to 24 lb)	8-15	325 °F (163 °C)	180 °F (82 °C)	
	Turkey Breasts (4 to 6 lb)	18-23	325 °F (163 °C)	170 °F (77 °C)	
	Cornish Hen (1 to 1.5 lb)	50-75 total	325 °F (163 °C)	180 °F (82 °C)	
Lamb	Half Leg (3 to 4 lb)	Medium	25-30	325 °F (163 °C)	160 °F (71 °C)
		Well Done	30-35	325 °F (163 °C)	170 °F (77 °C)
	Whole Leg (6 to 7 lb)	Medium	25-30	325 °F (163 °C)	160 °F (71 °C)
		Well Done	30-35	325 °F (163 °C)	170 °F (77 °C)

**NOTE** \* Stuffed turkey requires additional roasting time. The minimum safe temperature for stuffing in poultry is 165 °F (74 °C).

## Timed cooking

The Cook Time function lets you program the oven to cook food at a set temperature for a desired length of time. At the end of the set time, the oven will automatically shut off.

### CAUTION

Use caution when using the Cooking Time or Delay Start functions. These functions are best used when cooking cured or frozen meats and most fruits and vegetables. Foods that can easily spoil, like milk, eggs, fish, poultry, and meats, should be chilled in a refrigerator before they are placed in the oven. Even when chilled, they should not stand for more than 1 hour before cooking begins and should be removed promptly when cooking is completed. Eating spoiled food can result in sickness from food poisoning.

### How to set the oven for timed cooking

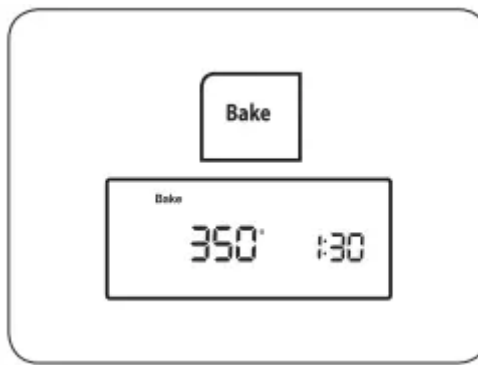

1. Position the oven rack in the desired location. Place the food in the oven, and then close the oven door.
2. Press the Bake pad. The default temperature, 350°, will blink on the display. If the default temperature is the desired cooking temperature, skip to step 4.

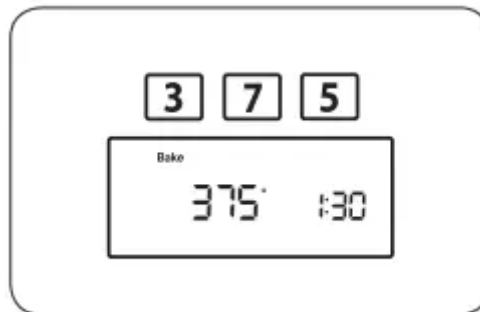

3. Press the number pads to enter the desired cooking temperature (for example, 3, 7, 5). The selected cooking temperature will blink on the display.

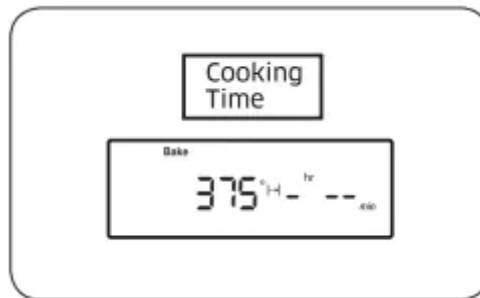

4. Press the Cooking Time pad. The display will show -hr --min. (hr, min characters are not displayed on the NX58\*560\*\*\*, NX58\*751\*\*\*)

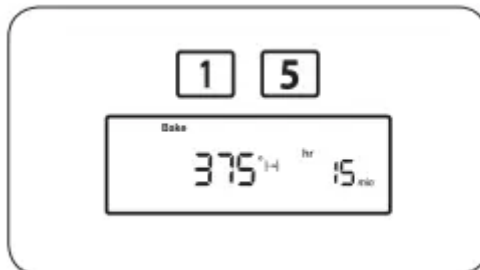

5. Press the number pads to enter the desired cooking time. The display will show the selected time, and the Start indicator will blink. You can set the time to any duration between 1 minute and 9 hours and 99 minutes.

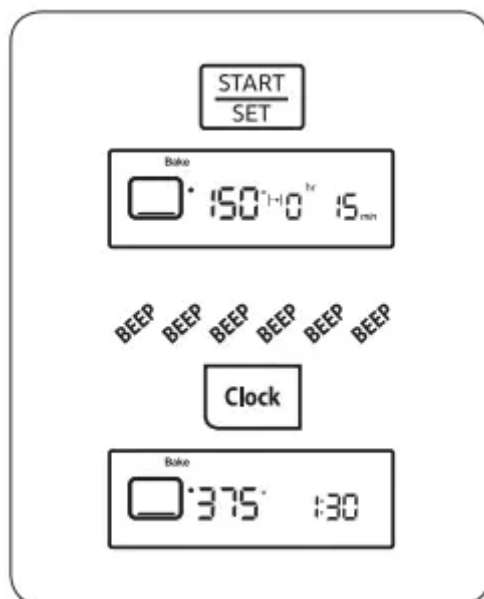

Press the START/SET pad. The oven will automatically light and start preheating. The display will show a blinking “•” along with the default or selected temperature, Bake, and the bake element icon, until the oven reaches that temperature. When the oven reaches the desired temperature, it will beep 6 times. The oven will start cooking for the set amount of time, and the remaining cooking time will be displayed. To see the time of day, press and hold the Clock pad. When the Clock pad is released, the display will go back to the remaining cooking time. When the cooking time has elapsed, the oven will automatically shut off and the display will show the time of day.

**To change a programmed baking temperature**, press the Bake pad, enter the new baking temperature, and press the START/SET pad. If the oven temperature is above the new setting, the oven will beep 6 times, then show the new setting. The oven will complete cooking at the new temperature.

**To change a programmed cooking time**, press the Cooking Time pad, enter the new cooking time, and then press the START/SET pad. The oven will continue cooking for the remaining new set time.

**NOTE** Place food in the oven after preheating if the recipe calls for it. Preheating is important for good baking results. After the oven has reached the desired cooking temperature, it will beep 6 times.

## Delay timed cooking

The Delay Start function lets you use the kitchen timer to automatically start and stop another cooking program (Bake, Convection Bake, or Convection Roast). Delay Start can be set before

other cooking operations by up to 12 hours. The clock must be set to the correct time of day for Delay Start to work properly.

### CAUTION

Use caution when using the Cooking Time or Delay Start functions. These functions are best used when cooking cured or frozen meats and most fruits and vegetables. Foods that can easily spoil, like milk, eggs, fish, poultry, and meats, should be chilled in a refrigerator before they are placed in the oven. Even when chilled, they should not stand for more than 1 hour before cooking begins and should be removed promptly when cooking is completed. Eating spoiled food can result in sickness from food poisoning.

### How to set the oven for delay timed cooking

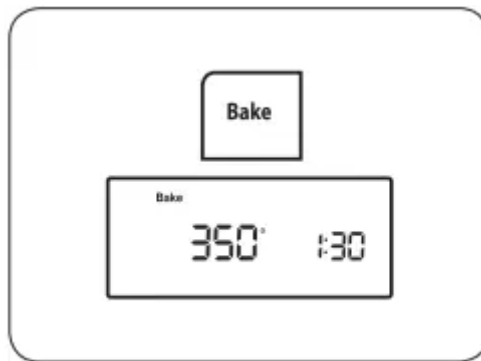

1. Position the oven rack in the desired location. Place the food in the oven, and then close the oven door.
2. Press the pad for the desired cooking operation, e.g., Bake. The default temperature, 350°, and the Start indicator will blink on the display. If the default temperature is the desired cooking temperature, skip to step 4.

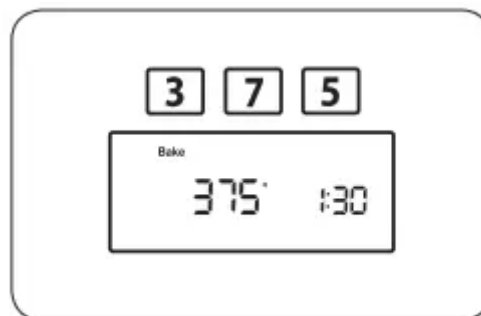

3. Press the number pads to enter the desired cooking temperature (for example, 3, 7, 5). The selected cooking temperature and the Start indicator will blink on the display.

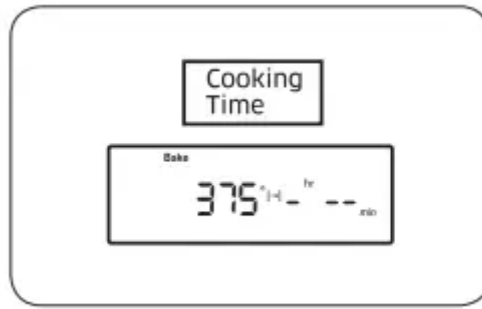

4. Press the Cooking Time pad. The display will show the selected cooking temperature, Bake, and -hr --min. (HR, min characters are not displayed on the NX58\*560\*\*\*, NX58\*751\*\*\*)

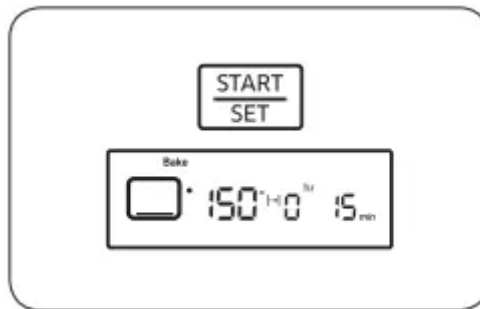

5. Press the number pads to enter the desired cooking time. The display will show the selected cooking time, and the Start indicator will blink. You can set the time to any amount of time between 1 minute and 9 hours and 99 minutes.

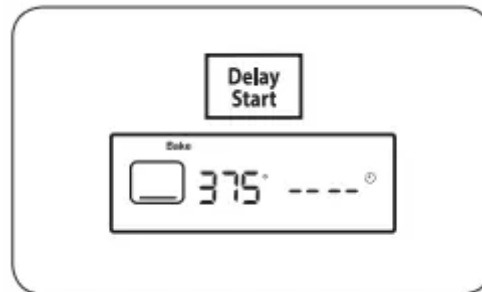

6. Press the Delay Start pad. The display will show Delay, and -- -- will blink.

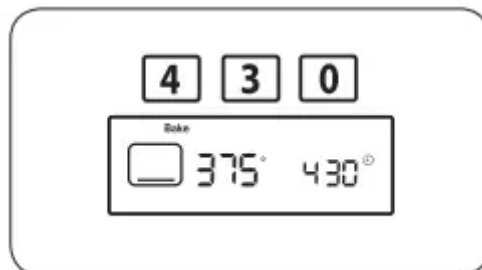

7. Press the number pads to enter the time you want the oven to turn on (for example, 4, 3, 0). The Start indicator will blink under Delay and the selected start time.

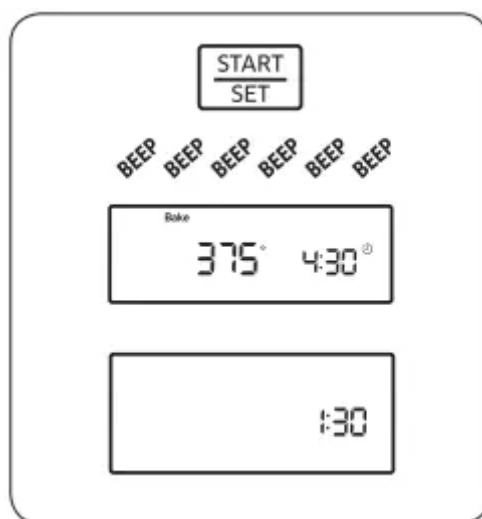

8. Press the START/SET pad. The oven will automatically turn on and beep when the set start time is reached. The oven will automatically light and start preheating. When the oven reaches the desired cooking temperature, it will beep 6 times. The display will count down the set cooking time. When the cooking time has elapsed, the oven will automatically shut off and the display will show the time of day.

**To change a programmed starting time**, press the Delay Start pad, enter the new starting time, and then press the START/SET pad. The oven will start cooking at the new start time.

**To change a programmed baking temperature**, press the Bake pad, enter the new baking temperature, and then press the START/SET pad. If the oven temperature is above the new setting, the oven will beep 6 times, then show the new setting. The oven will complete cooking at the new temperature.

**To change a programmed cooking time**, press the Cooking Time pad, enter the new cooking time, and then press the START/SET pad. The oven will continue cooking for the remaining new set time.

**NOTE** Place food in the oven after preheating if the recipe calls for it. Preheating is important for good baking results. After the oven has reached the desired cooking temperature, it will beep 6 times.

## Broiling

The Broil function allows you to cook and brown foods using only a top heat source. The oven door must remain closed during broiling. The meat or fish should always be placed on a broiling grid in a broiling pan.

## CAUTION

If a fire occurs during broiling, leave the oven door closed and turn off the oven. If the fire continues, throw baking soda on the fire or use a foam-type fire extinguisher. Do not throw water or

flour on the fire. Flour may explode and water can cause a grease fire to spread. Both can cause personal injury and/or property damage.

### How to set the oven for broiling

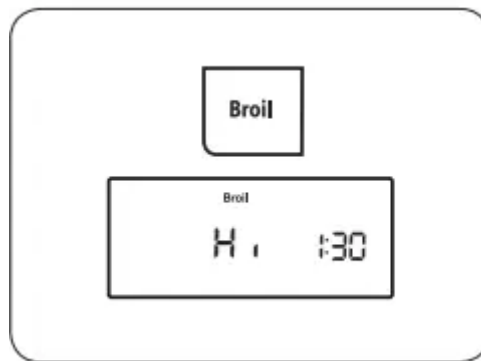

1. Place the food on a broiling pan with insert grid. Place the food and pan on the top oven rack, positioned as recommended in the Broiling guide on page 47. Close the oven door.
2. Press the Broil pad once for Hi and twice for Lo. The oven will beep every time a pad is pressed. The Start indicator will blink to the right of Hi or Lo and Broil on the display. Use Lo to cook foods such as poultry or thick cuts of meat thoroughly without overbrowning them.

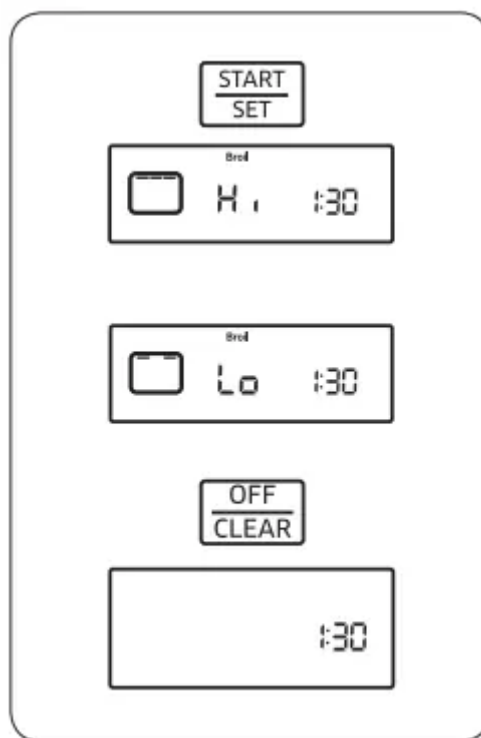

3. Press the START/SET pad. The oven will automatically light the top oven burner and start cooking. The display will show the selected broil setting (Hi or Lo), the broil element icon, and Broil. Broil on one side until food is browned; turn and cook on the other side. When cooking is completed, press the OFF/CLEAR pad to shut off the oven or to cancel broiling at any time. The display will show the time of day.

**To change a programmed broiling setting**, press the Broil pad to toggle the setting between Hi and Lo. Press the START/SET pad to complete cooking at the new setting.

**Broiling guide**

The size, weight, thickness, broiling temperature setting, and your preference of doneness will affect the broiling time. The following guide is based on meats and/ or fish starting at refrigerator temperature.

Food	Quantity and/or Thickness	Rack position*	1st side time (min.)	2nd side time (min.)	Comments
<b>Ground Beef</b>	1 lb (4 patties) 0.5- to 0.75" thick	6 or 7	7-10	5-7	Space evenly. Up to 8 patties may be broiled at once.
Well Done					
<b>Beef Steaks</b>	1" thick 1 to 1.5 lbs	6	10-12	5-7	Steaks less than 1" thick cook through before browning. Pan frying is recommended. Slash fat.
Medium					
Well Done					
Medium					
	1.5" thick 2 to 2.5 lbs	6	15-18	14-17	
Well Done					
<b>Chicken</b>	1 whole cut-up 2 to 2.5 lbs Split lengthwise	4	30-35	15-20	Broil skin-side-down first. Spread open. Brush with melted butter before and halfway through broiling.
	2 breasts	5	15-20	7-12	



Food	Quantity and/or Thickness	Rack position*	1st side time (min.)	2nd side time (min.)	Comments
Fish Fillets	0.25- to 0.5" thick	6	6-10	3-4	Handle and turn very carefully. Brush with lemon butter before and during cooking, if desired.
Ham Slices (precooked)	0.5" thick	6	7-10	5-6	Increase time 5 to 10 minutes per side for 1.5" thick or home-cured ham.
Pork Chops					
Well Done	2 (0.5" thick)	6	8-11	4-6	Slash fat.
Lamb Chops					
Medium	2 (1" thick)	6	8-12	5-8	-
Well Done	about 10 to 12 oz	6	10-16	7-11	Slash fat.

**NOTE** \* See illustration on page 35 for description of rack positions.

## Keep warm

The Keep Warm function allows you to keep cooked foods warm at a low baking temperature. The Keep Warm feature keeps cooked food warm for serving up to 3 hours after cooking has finished. After 3 hours, the feature automatically shuts off the oven.

### How to use the keep warm feature

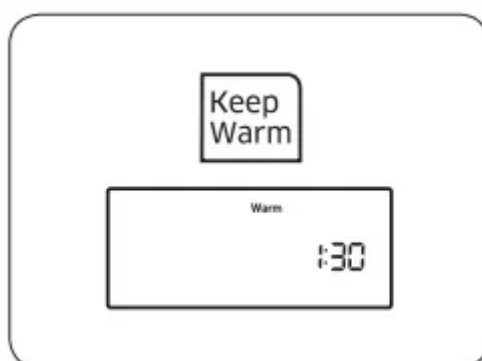

1. Position the oven rack in the desired location. Place the food in the oven and close the oven door.
2. Press the Keep Warm pad. The Start indicator will blink under the time of day and Warm appears on the display.

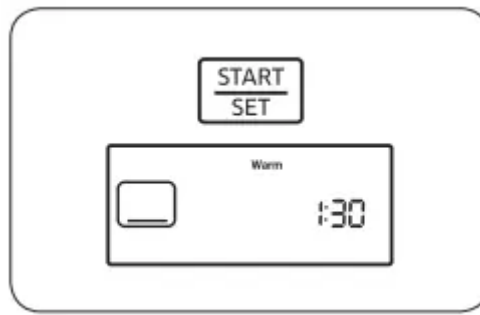

3. Press the START/SET pad. The oven will automatically light and start preheating to the Keep Warm temperature (approx. 170 °F [77 °C]). The display will show the oven element icon, Warm, and the time of day. To cancel Keep Warm and shut the oven off, press the OFF/CLEAR pad. The display will show the time of day.

**To program Keep Warm after a timed cooking function**, press the Keep Warm pad after you program the timed cooking function. When Time Cook is complete, the oven will beep 6 times and lower the oven temperature to the Keep Warm setting. The oven will maintain that temperature until Keep Warm is canceled.

## Maintaining your appliance

### WARNING

- Always make sure the controls are OFF and all surfaces are cool before removing and/or cleaning any of the range parts. This will prevent you from getting burned.
- If the range is pulled out from the wall for any reason, make sure the anti-tip device is reengaged after the range has been pushed back into place. Failure to take this precaution could result in the range tipping and personal injury.

### Care and cleaning of the oven

The oven and surface burner control panels can be easily cleaned with a damp cloth and/or glass cleaner. Heavily soiled areas can be cleaned with warm, soapy water.

**NOTE** Never use steel wool or abrasive cleansers. Protect the surface from sharp objects. All of the above items can damage the surface

### Oven control panel

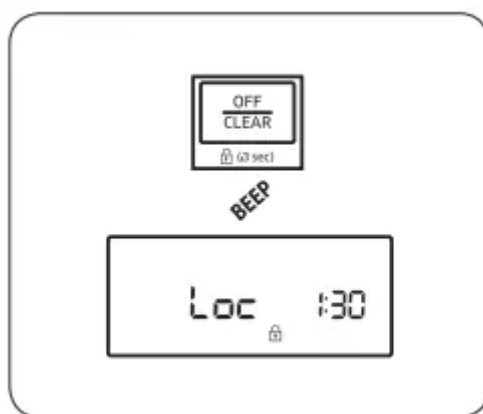

1. To lock the oven controls and the oven door, press and hold the OFF/CLEAR pad for 3 seconds. This prevents accidental oven operation and appliance tipping. The oven will beep and the display will show Loc, the time of day, and the Lock icon.

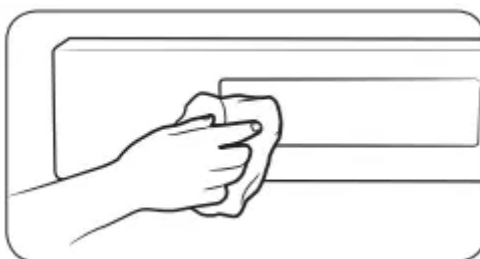

2. Clean spatters with a damp cloth, glass cleaner, or warm, soapy water.

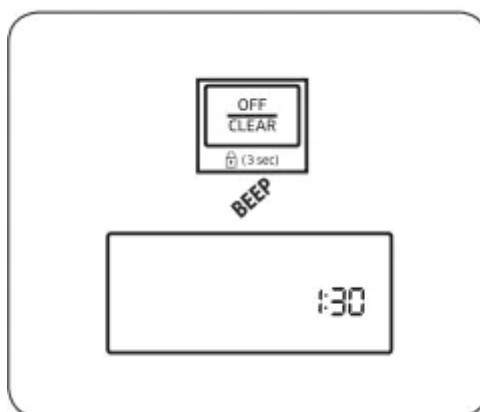

3. To unlock the controls and the door, press and hold the OFF/CLEAR pad for 3 seconds. To unlock just the controls, hold the door slightly open while pressing and holding the OFF/CLEAR pad for 3 seconds. The oven will beep, and Loc and the Lock icon will disappear from the display. Close the oven door, if you are holding it open.

### **Stainless steel surfaces**

**WARNING** Do not use a steel-wool pad or abrasive cleaners on stainless steel surfaces. Abrasive pads and cleaners will scratch the surface and damage the surface finish.

**NOTE** To prevent any discolorations and/or grease stains, we recommend cleaning and removing any spills, spots, and grease from the range after each use.

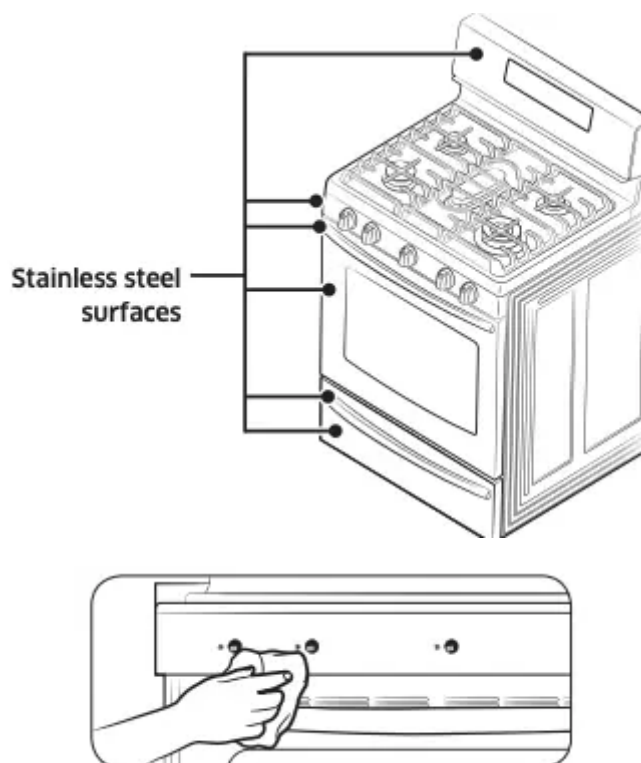

1. Wipe off any spills with a damp, soft cloth.
2. Apply an approved stainless steel cleaner to a damp, clean cloth or paper towel. Clean a small area carefully following the instructions on the cleaner. Stainless steel should always be cleaned with the grain in the stainless steel, if applicable.
3. Dry and buff with a clean, dry, soft cloth.
4. Repeat steps 2 and 3 as necessary.

### **WARNING**

Do not spray any type of cleaner into the manifold panel holes. Within these holes are ignition switches which carry the current that lights the surface burners. Spraying into them could damage the range.

### **Oven racks**

- If the racks are left in the oven during a self-cleaning cycle, their color will turn slightly blue and the finish will be dull. After the self-cleaning cycle is complete and the oven has cooled, rub the sides of the racks with wax paper or a cloth containing a small amount of oil. This will help the racks glide more easily into their tracks.
- Gliding racks may be cleaned by hand with an abrasive cleaner or steel wool. During cleaning, be careful not to allow water or cleaner to enter the slides on the sides of rack.

### **NOTE**

- Do not clean in a dishwasher.

- If the rack becomes hard to remove or replace, lightly wipe the oven rack guides with cooking oil. Do not wipe cooking oil on the slides.
- If the rack becomes difficult to slide, the rack may need to be lubricated using Graphite Lubrication.

**To lubricate the slides**

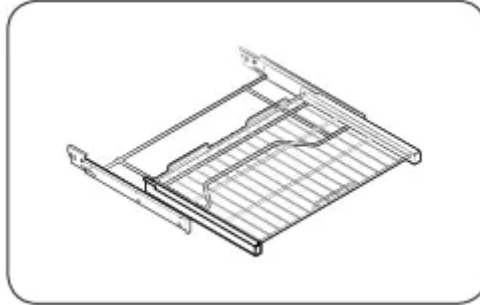

1. Remove the rack from the oven. See removing the gliding rack in the Using the gliding rack section.
2. Fully extend the rack on a table or countertop. Newspaper may be placed underneath the rack for easy cleanup.

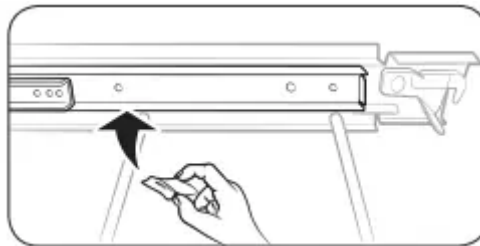

3. If there is debris in the slide tracks, wipe it away using a paper towel. (Any graphite lubricant wiped away must be replaced - See steps 4 through 7.)

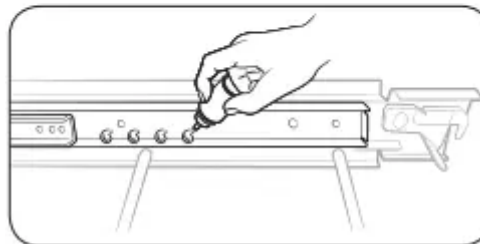
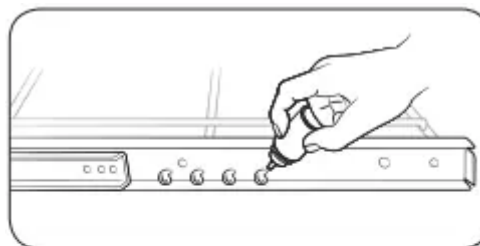

4. Shake the graphite lubricant before opening it. Starting with the left (front and back) slide mechanism of the rack, place four (4) small drops of lubricant on the two (2) bottom tracks of the slide close to the bearing carriers.

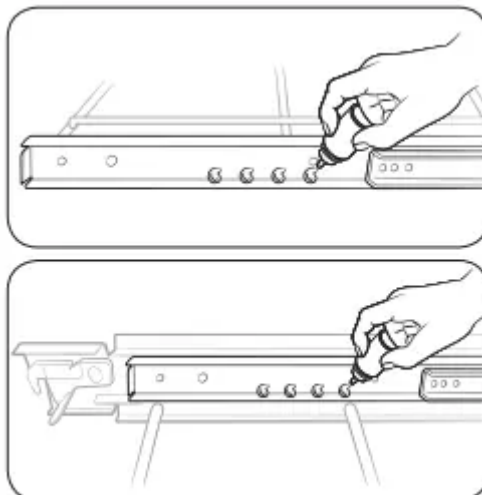

5. Repeat for the right (front and back) slide mechanism of the rack.

6. Open and close the rack several times to distribute the lubricant.

7. Replace the cap on the lubricant and shake it again. Turn the rack over and repeat steps 3, 4, 5 and 6.

8. Close the rack, turn rack right-side-up and place in the oven. See installing the gliding rack in the Using the gliding rack section.

**NOTE** Do not spray the gliding rack with cooking spray or other lubricant sprays.

### Oven racks

To keep racks shiny and looking like new, remove racks from the oven and clean by hand in hot, soapy water with a plastic or soap-filled scouring pad.

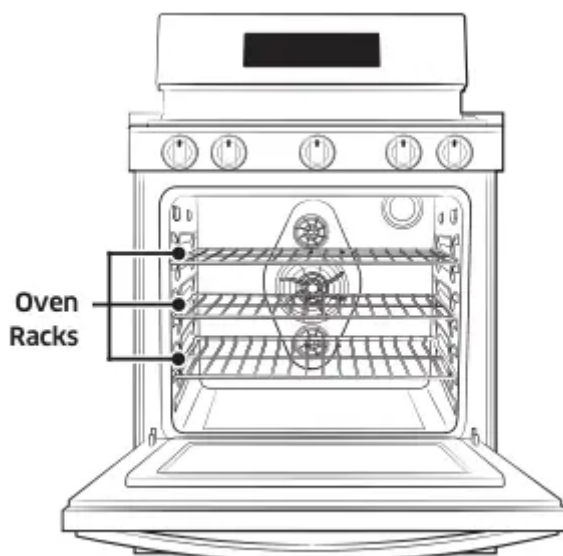

**CAUTION** Do not leave the oven racks in the oven during a self-cleaning cycle. The extreme heat in the self-cleaning cycle will permanently discolor the oven racks and make them difficult to slide. If racks become difficult to slide, rub the side rails with wax paper or a cloth containing a small amount of cooking oil. This will help the racks slide more easily in the tracks.

### Oven door

**WARNING** Do not allow moisture to enter the door or contact the door gasket during cleaning. Moisture entering the door assembly and or getting on the door gasket will damage the gasket.

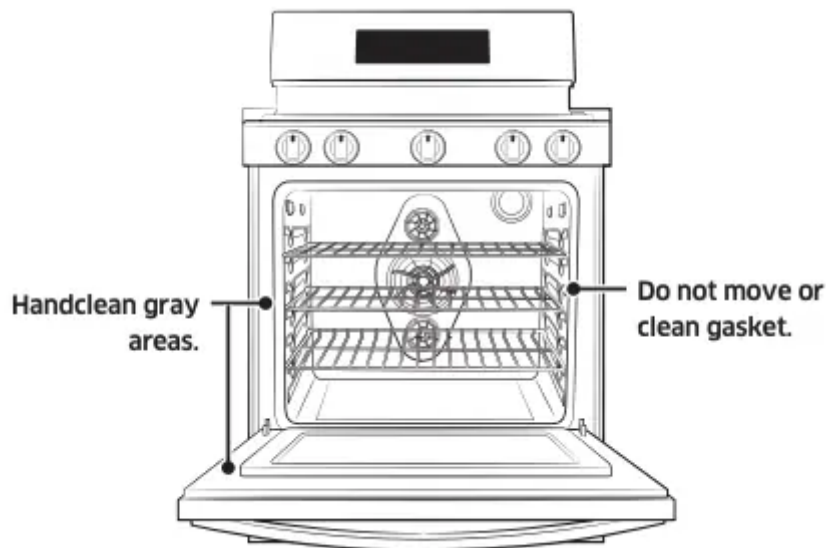

The oven door has multiple surfaces that require different cleaning techniques. The gasket on the inside surface of the oven door should never be cleaned or moved to clean other surfaces. The gasket is made of woven material which is essential for a good heat seal.

The inside door surface outside of the gasket should be cleaned by hand with hot, soapy water and a soapy plastic scouring pad. Rinse and dry thoroughly with a clean, soft cloth. Do not get the gasket wet or allow moisture to get inside the door assembly.

The inside door surface inside of the gasket and the inside door glass are cleaned during the oven's self-cleaning cycle.

The outside door surface is stainless steel and should be cleaned using the instructions on page 60.

The outside glass surface can be cleaned with glass cleaner or warm, soapy water with a thorough rinse. Do not let moisture get inside of the door assembly.

## Care and cleaning of the cooktop

### Surface burner controls

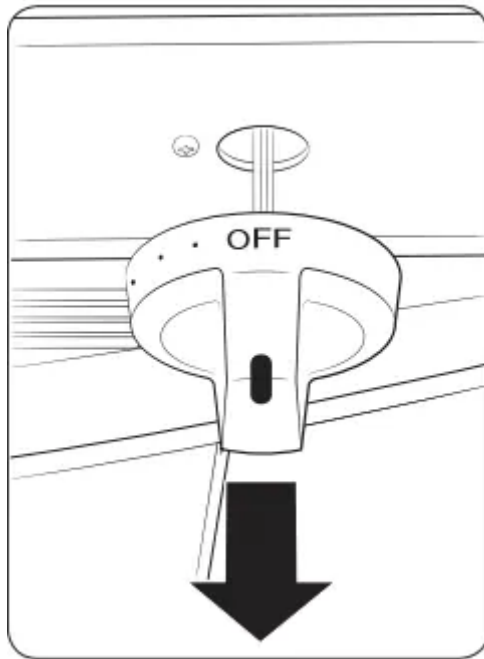

1. Make sure all surface burner knobs are in the OFF position.
2. Pull the control knobs straight off the surface burner control valve stems.

**CAUTION** Do not clean the control knobs in a dishwasher. They are not dishwasher-safe.

3. Clean the control knobs in warm, soapy water. Rinse and completely dry all surfaces (including back and stem hole).

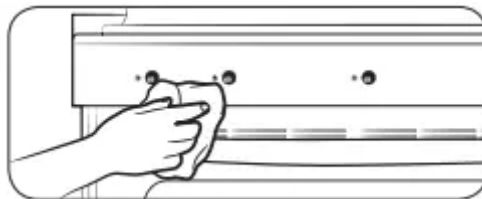

**WARNING** Do not use spray cleaners on the surface burner control panel. Spray entering the valve holes could contact electrical components resulting in death, personal injury, or product damage.

4. Clean stainless steel surfaces with stainless steel cleaner on a damp, soft cloth. See page 60.

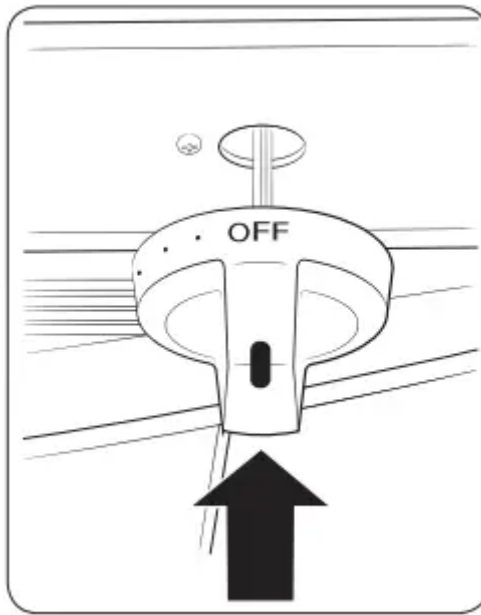

5. Replace the control knobs in the OFF position by pushing them straight onto the control valve stems.

### **Cooktop surface**

The cooktop surface is a porcelain-enamel surface. To prevent this surface from becoming dull, wipe up and clean spills as they happen. Foods with a lot of acid (tomatoes, sauerkraut, fruit juices, etc.) or foods with high sugar content can cause dull spots if allowed to set.

**WARNING** Do not use a steel-wool pad or abrasive cleaners on porcelain-enamel surfaces. Abrasive pads and cleaners will scratch and damage the surface.

1. Make sure all surface burners are OFF

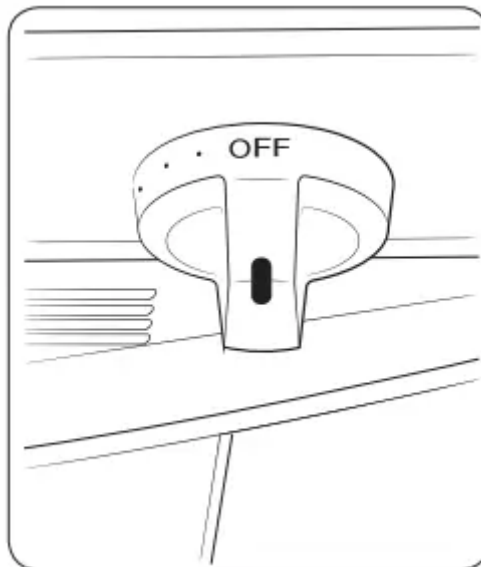

2. When surfaces have cooled, remove the burner grates.

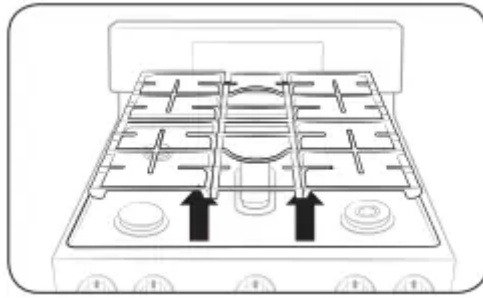

**WARNING** Do not remove or lift the cooktop during cleaning. Doing so could damage the gas lines leading to the surface burner manifolds, causing poor and/or dangerous operation.

3. Clean the cooktop surface with warm, soapy water and a soft, damp cloth. If spill goes under a surface burner, remove the surface burner cap and head to access and clean the spill.

4. Rinse with clean water and dry and polish with a soft, dry cloth.

5. Reassemble burner components (if removed) and replace the burner grates.

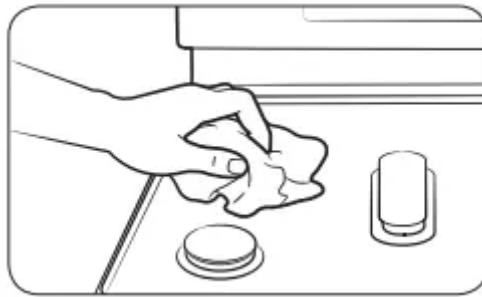

## Changing the oven light

The oven light is a standard 40-watt appliance bulb. It will automatically come on when the oven door is opened. It can also be turned on and off when the oven door is closed by pressing the Oven Light pad on the oven control panel.

**NOTE** The oven light will not work during a self-cleaning cycle.

**WARNING** Disconnect electrical power to the range before replacing the oven light. This will prevent any personal injury due to electric shock.

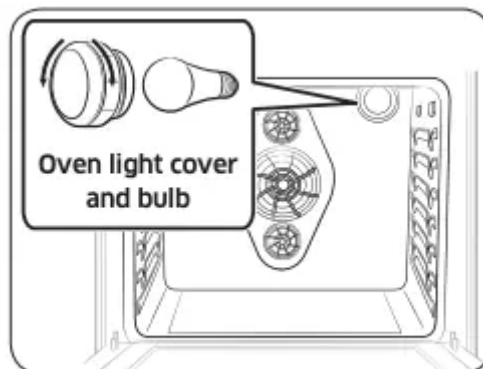

1. Make sure the oven and the light bulb are cool.

2. Open the oven door.

**NOTE** If the oven racks are in the way, they can be repositioned or removed before you change the oven light.

3. Turn the glass light cover in the rear upper-right corner counterclockwise to remove it.

4. Turn the bulb counterclockwise to remove it from its socket.

5. Replace the bulb with a new 40-watt appliance bulb. Turn the bulb clockwise until it is seated securely in the socket.

6. Replace the glass light cover by turning it clockwise until it is seated securely.

7. Close the oven door and reconnect the electrical power to the range.

### Removing and replacing the storage drawer (Model NX58\*560\*\*\*, NX58\*751\*\*\*)

#### To remove the storage drawer

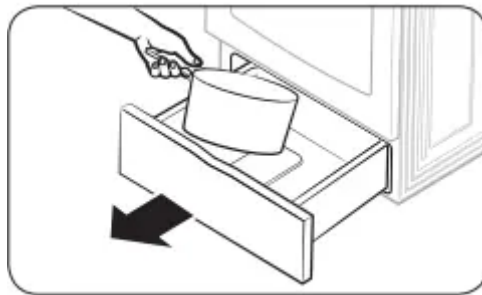

1. Pull out the drawer and remove any stored content.

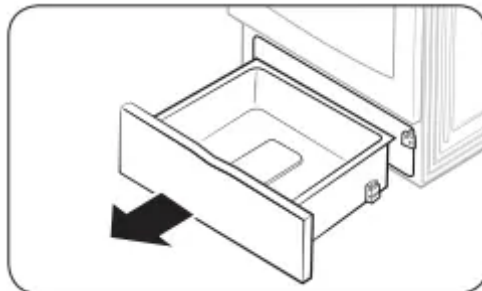

2. While supporting the drawer, pull it out until the top of the drawer sides come out of the two nylon drawer guides. Then, lift to remove the drawer.

3. Clean the drawer in warm, soapy water. Rinse and dry thoroughly.

#### To replace the storage drawer

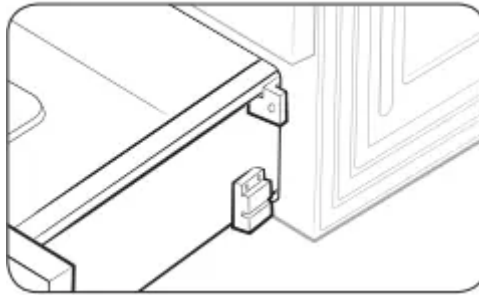

1. Place the top of both drawer sides in the openings on the two nylon drawer guides and push in enough to support the drawer.

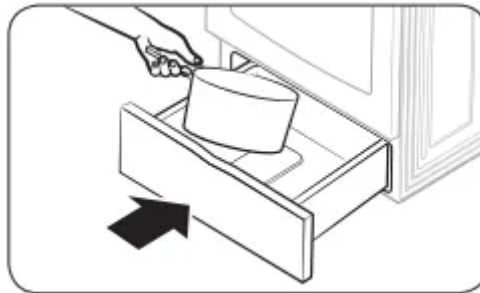

2. Replace any stored content and push in the drawer while slightly lifting the front to close it.

## Self-cleaning oven

The self-cleaning oven uses high temperatures (well above cooking temperatures) to burn off left over grease and residue completely or reduce them to a finely powdered ash that can be wiped away with a damp cloth.

**WARNING** Failure to follow these precautions could result in damage to the oven, fire, and/or personal injury.

- Do not leave small children unattended near the range during a self-cleaning cycle. The outside surfaces of the range can get extremely hot.
- Some birds are extremely sensitive to fumes from a self-cleaning oven. Relocate birds to a well-ventilated room away from the range.
- Do not line the oven, oven racks, or oven bottom with aluminum foil. Doing so will result in poor heat distribution, produce poor baking results, and cause permanent damage to the oven interior. The aluminum foil will melt onto and adhere to the interior oven surfaces.
- Do not force the oven door open during the self cleaning cycle. It will damage the automatic door-locking system. The door automatically locks when the self-cleaning cycle is started and stays locked until the cycle is cancelled and the oven temperature is below 350 °F.
- Be careful opening the oven door after a self-cleaning cycle. The oven will still be VERY HOT and hot air and steam might escape when the door is opened.

## Before a self-cleaning cycle

**NOTE** Remove the racks. Leaving the oven racks in the oven during a self-cleaning cycle will discolor the oven racks and make them difficult to slide in and out of position.

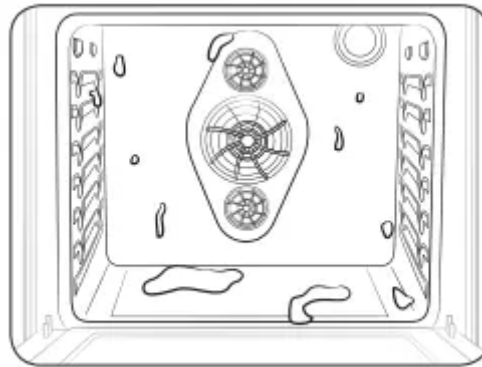

- Make sure the door lock feature is turned off and the oven is cool. If they are not, the self-cleaning cycle will not start.
- On model NX58\*565\*\*\*, make sure the warming drawer is turned off. Self-clean will not start when the drawer is on.

**WARNING** Do NOT use the surface burners while the oven is operating in the self clean mode.



- A blinking Loc icon indicates the oven door is in the process of being locked.



- When the Loc icon is on, the oven door is locked.

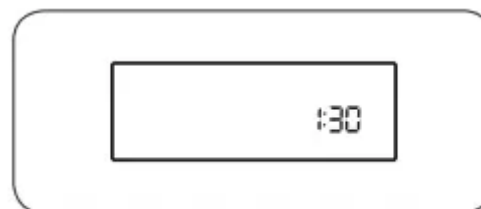

- When Loc is shown in the display, it indicates the door lock feature is on. Press and hold the OFF/CLEAR pad for 3 seconds to unlock the oven controls.

### How to set the oven for self-cleaning

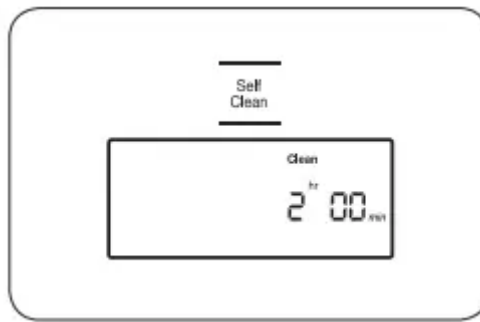

1. Make sure the oven door is completely closed.
2. Press the Self Clean pad on the oven control panel. Press the pad once for a 2-hour cleaning cycle, twice for a 3-hour cleaning cycle, or three times for a 4-hour cleaning cycle. Pressing the pad a fourth time will reselect the 2-hour default time. The display will show Clean, and the Start indicator will blink under the selected cleaning cycle time.

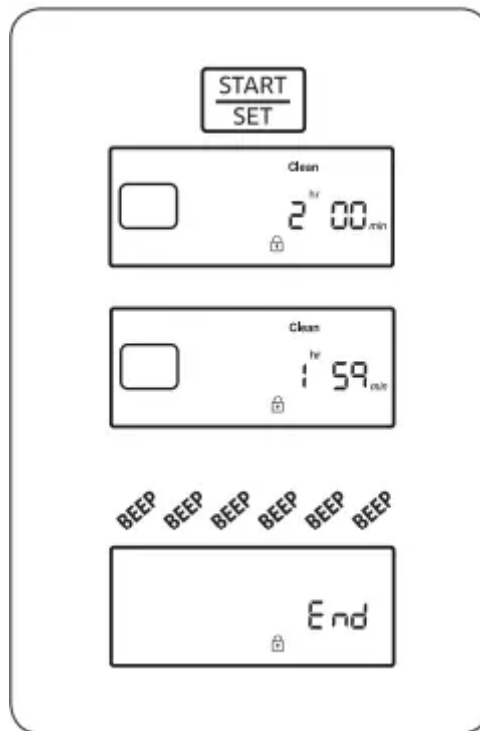

3. Press the START/SET pad to start the cycle. The display will show Clean and the selected cleaning cycle time, and the Lock icon will blink until the door is locked. Then the Lock icon will stay on until the cycle is over and the oven temperature is below 350 °F (177 °C). The oven temperature will rise and hold the preset self-clean temperature for the duration of the selected cleaning cycle. The display will count down the cleaning cycle in minutes and hours. When the time elapses, the oven will turn off and beep 6 times. End will show in the display and the Lock icon will blink. When the oven temperature falls below 350 °F (177 °C), the door unlocks and the Lock icon turns off.

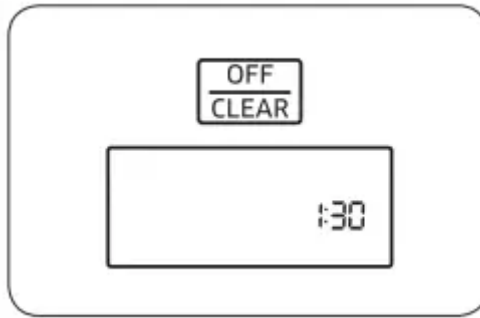

4. Press the OFF/CLEAR pad. The display will go back to showing the time of day.

**How to delay the start of self-cleaning**

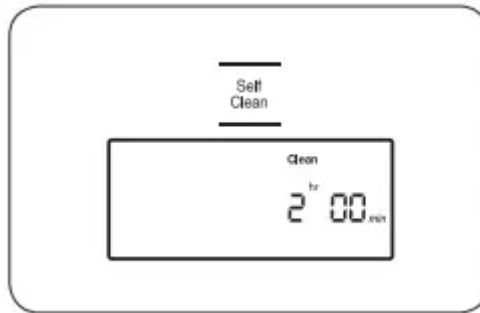

1. Make sure the oven door is completely closed.
2. Press the Self Clean pad on the oven control panel. Press the pad once for a 2-hour cleaning cycle, twice for a 3-hour cleaning cycle, or three times for a 4-hour cleaning cycle. The display will show Clean, and the Start indicator will blink under the selected cleaning cycle time.

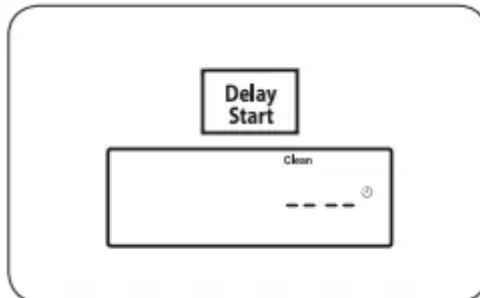

3. Press the Delay Start pad. The display will show Delay and -- --.

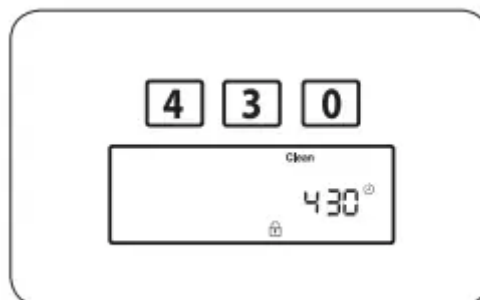

4. Press the number pads to set the time you want the oven to turn on, e.g., 4, 3, 0. The Start indicator will blink under the selected delay start time and Delay on the display.

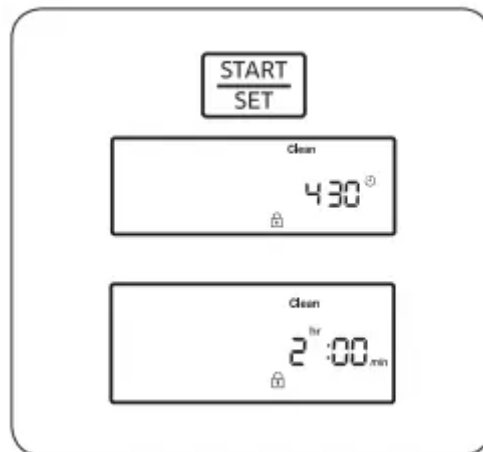

5. Press the START/SET pad. The display will show the Delay Start time and the Lock icon. The oven door lock will engage automatically. When the start time is reached, the oven will turn on automatically and start the programmed cleaning cycle.

### How to cancel self-cleaning

You may find it necessary to stop or interrupt the self-cleaning cycle due to excessive smoke or fire in the oven

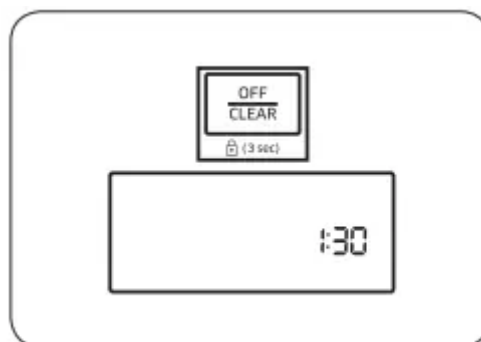

- Press the OFF/CLEAR pad.

The oven will turn off. The Lock icon will blink under the current time of day on the display. When the oven temperature falls below 350 °F (177 °C), the oven door unlocks and the Lock icon turns off.

### After self-cleaning

**CAUTION** Be careful opening the oven door after a self-cleaning cycle. The oven is still very hot when the door unlocks. Escaping hot air and/or steam could burn you.

- The internal oven temperature must be below 350 °F for the automatic door lock to disengage. The door lock must be disengaged before another cooking function can be set.
- After the oven has cooled, wipe down the oven surfaces with a damp cloth to remove any ash residue.

- Stubborn spots can be cleaned with a soap-filled steel-wool pad. Lime deposits can be removed with a cloth soaked in vinegar. Rinse thoroughly after cleaning.
- If the oven is not clean after one cycle, repeat the cycle. If the oven is still hot, HOT will appear on the display until the oven is cool enough to start a new cycle.
- Self-cleaning does not operate within 2 hours after running the self-cleaning cycle.

## **Troubleshooting**

Samsung works hard to ensure that you don't have problems with your new gas range. If you experience a problem, look first for a solution in the table below. If, after trying the suggested solution, you're still having trouble, call Samsung at 1-800-SAMSUNG (726-7864).

### **You smell gas.**

There is a gas leak. The surface burner knob is not in the 'off' position, yet the burner itself is not ignited.

- Clear the room, building, or area of all occupants.
- Immediately call your gas supplier from a neighbor's phone. Do not call from your phone. It is electrical and could cause a spark that could ignite the gas. Follow the gas supplier's instructions.
- If you cannot reach your gas supplier, call the fire department.

### **The range is not level.**

The appliance has been installed improperly. The leveling leg(s) is (are) damaged or uneven.

- Make sure the floor is level, strong, and stable. If the floor sags or slopes, contact a carpenter.
- Check and level the range. (See the Installation Instructions.)

The kitchen cabinets are not properly aligned and make the range appear to be not level.

- Ensure that cabinets are square and provide sufficient room for installation.

### **The oven control beeps and displays an error code.**

You have a function error code. See the Troubleshooting and information codes chart on page 80.

- Press the OFF/CLEAR pad and restart the oven. If the problem persists, disconnect all power to the range for at least 30 seconds and then reconnect the power. If this does not solve the problem, call for service.

### **All burners do not light.**

The power cord is not plugged into the electrical outlet.

- Make sure the electrical plug is plugged into a live, properly grounded outlet.

A fuse in your home may be blown or the circuit breaker tripped.

- Replace the fuse or reset the circuit breaker.

The gas supply is not properly connected or turned on.

- See the Installation Instructions that came with your range.

### **Surface burners do not light.**

The control knob is not set properly.

- Push in the control knob and turn it to the LITE position.

The burner caps are not in place. The burner base is misaligned.

- Clean the electrodes. Put the burner cap on the burner head. Align the burner base.

### **Surface burner clicks during operation.**

The control knob has been left in the LITE position.

- After the burner lights, turn the control knob to a desired setting. If the burner still clicks, contact a service technician.

### **The burners do not burn evenly.**

Surface burner components and caps are not assembled correctly and level.

- See page 64.

Surface burners are dirty.

- Clean surface burner components. (See pages 64 and 65.)

### **Very large or yellow surface burner flames.**

Wrong orifice is assembled.

- Contact your installer. Check the burner orifice size and contact your installer if you have the wrong orifice. Check the LP gas conversion

### **Surface burners light but oven burners do not light.**

The oven door lock is turned on.

- The display will show the Lock icon. Hold the oven door open and press the START/ SET pad for 3 seconds. The oven will beep and the Lock icon will turn off.

Gas Pressure Regulator shut off switch is in the 'off position.

- Call a qualified service technician.

### **Display goes blank.**

The electrical outlet Ground Fault Interrupter (GFI or GFCI) has been tripped and needs to be reset.

Your digital control has been damaged.

- Replace fuse or reset circuit breaker.

**Very large or yellow oven burner flames**

The oven burner air adjustment shutters need to be adjusted.

- Call for a qualified service technician.

Gas supply is not properly connected or turned on.

- See the Installation Instructions that came with your range.

**Food does not bake or roast properly in the oven.**

Wrong cooking mode is selected.

- See pages 30-31, 41,

The oven racks have not been positioned properly for the foods being cooked.

- See page 35.

Incorrect cookware or cookware of improper size being used.

- See page 27.

Oven thermostat needs adjustment.

- See page 39.

There is aluminum foil on racks and/or oven bottom.

- Remove foil.

Clock or timers not set correctly.

- See pages 33 and 34.

**Food does not broil properly in the oven.**

Oven controls not set properly.

- See page 46.

Oven door was not closed during broiling.

- See page 32.

The rack has not been properly positioned.

- See Broiling guide on page 47

**Oven temperature is too hot or cold.**

Oven thermostat needs adjustment.

- See page 39.



### **Oven burner will not shut off.**

The oven door lock is turned on.

- The display will show the Lock icon. Hold the oven door open and press the START/ SET pad for 3 seconds. The oven will beep and the Lock icon will turn off.

The Sabbath function has been activated.

- SAb and the time of day will show in the display. All other controls and signals will be deactivated. To turn off the oven only, press the OFF/CLEAR pad. To cancel the Sabbath function and reactivate the controls and signals, press and hold the SABBATH pad for 3 seconds.

### **Oven light (lamp) will not turn on.**

The oven door lock is turned on.

- The display will show the Lock icon. Hold the oven door open and press the START/ SET pad for 3 seconds. The oven will beep and the Lock icon will turn off.

The Sabbath function has been activated.

- SAb and the time of day will show in the display. All other controls and signals will be deactivated. To cancel the Sabbath function and reactivate the light switch and other controls, press and hold the SABBATH pad for 3 seconds.

Loose or burned-out bulb.

- See page 67.

The switch operating the oven light needs to be replaced.

- Call for a qualified service technician.

### **Oven smokes excessively during broiling.**

Meat or food was not properly prepared before broiling.

- Cut away excess fat and/or fatty edges that may curl.

Improperly positioned top oven rack.

- See Broiling guide on page 47

Controls are not being set properly.

- See page 46.

Greasy buildup on oven surfaces.

- Regular cleaning is necessary when broiling frequently.

### **Oven will not self-clean.**

The oven door lock is turned on.

- The display will show the Lock icon. Hold the oven door open and press the START/ SET pad for 3 seconds. The oven will beep and the Lock icon will turn off.

The warming drawer is being used.

- Self-clean will not operate when the warming drawer is on.

The oven is too hot.

- Let the oven cool down and reset the controls. The self-clean cycle will not lock the oven door if the oven temperature is too hot. The door must lock before the self-clean cycle can start.

The self-cleaning oven controls are not properly set.

- Reset the self-cleaning oven controls. (See pages 72 and 73)

### **Crackling or popping sound.**

This is normal.

- This is the sound of the metal heating and cooling during any cooking or cleaning function.

### **Excessive smoking during a selfcleaning cycle.**

This is the first time the oven has been cleaned.

- This is normal. The oven will always smoke more the first time it is cleaned. Wipe up all excessive soiling before starting the selfcleaning cycle.
- If smoke persists, press the OFF/CLEAR pad. Open the windows to clear the smoke from the room. After the oven has cooled and unlocked, wipe up excessive soil and reset the oven for self-cleaning.

### **Oven door will not open after a self-cleaning cycle.**

This is normal.

- The oven door will stay locked until the oven temperature drops below 350 °F.

### **Oven not clean after a selfcleaning cycle.**

A fine dust or ash is normal.

- This can be wiped clean with a damp cloth. Set the self-cleaning cycle for a longer cleaning time. The cycle was not long enough to burn off the dirt buildup.
- Extremely dirty ovens require hand-cleaning of excessive spillovers and food buildup before starting a self-cleaning cycle. Multiple self-cleaning cycles may be necessary to completely clean the oven.

### **Steam or smoke coming from under the control panel.**

This is normal.

- The oven vent is located there. More steam is visible when using the convection functions or when baking or roasting multiple items at the same time.

**Burning or oily odor emitting from the vent.**

This is normal for a new oven and will disappear within 1/2 hour of the first bake cycle.

- To speed the process, set a self-cleaning cycle for a minimum of 3 hours. (See pages 72 and 73.)

**Strong odor.**

This is temporary.

- The insulation around the inside of the oven emits an odor the first few times the oven is used.

**Oven racks are difficult to slide.**

- Apply a small amount of vegetable oil to a paper towel and wipe edges of the oven racks with the paper towel. Racks become dull and hard to slide when they are left in the oven during a self-clean cycle.

**Fan noise.**

This is normal.

- The convection fan runs until the function is over or the door is opened.

**Convection fan is not working.**

- The fan starts automatically when the oven meets the preheat temperature.

**Warming drawer will not work (Model NX58\*565\*\*\*).**

The controls are not set properly.

- Reset the controls as described on pages 58.

The Self-Clean or Sabbath function is being used.

- The warming drawer will not operate during either of these operations. Try again after the function is completed or cancelled.

The oven controls have been locked.

- Unlock the controls and try again.

There is a blown fuse or tripped circuit breaker.

- Replace blown fuse or reset tripped circuit breaker.

**Excessive condensation in the warming drawer (Model NX58\*565\*\*\*).**

The temperature setting is too high.

- See page 58.

The foods being warmed are not covered with a lid or aluminum foil.

- Cover foods with a lid or aluminum foil.

You are trying to warm liquids.

- Liquid should not be warmed in the drawer. Remove liquids.

**Warming drawer or storage drawer does not slide smoothly or drags.**

The drawer is not properly aligned with the full-extension roller guide rails or nylon drawer guides.

- Remove and replace the drawer. (See pages 69 and 70)

The contents in the drawer are too heavy.

- Reduce the weight and/or redistribute the contents in the drawer.

## Troubleshooting and information codes

**SE** Shorted Key.



Check the Touch PBA signals.

**E-27** Oven sensor opened problem

**E-28** Oven sensor shorted problem.

**E-0A** Oven overheating.

**E-0E** Door locking error.

- Press the OFF/CLEAR pad and restart the oven.
- If the problem persists, disconnect all power to the range for at least 30 seconds and then reconnect the power.
- If this does not solve the problem, call for service. See the instructions below this chart.

For any codes not listed above, or if the suggested solution does not fix the problem, call 1-800-SAMSUNG (726-7864).

### Warning

This content is compiled from multiple sources and is provided for reference purposes only. It may not be complete or fully applicable to all situations. If you are unable to resolve your issue, please contact the product manufacturer or an authorized service provider for official support.

