



Before you start

Initial settings

Run Calibration (recommended)

Calibration ensures accurate weight detection by the washing machine. Make sure the drum is empty before running Calibration.

1. Power off, and then power on the washing machine.
2. Hold down  Temp. and  Delay End simultaneously for 3 seconds to enter Calibration mode. The “Cb” message appears.
3. Press Start/Pause to run the Calibration cycle.
4. The drum will rotate for about 3 minutes. (The direction of the drum rotation may differ depending on the model.)
5. When the cycle is complete, “0” appears on the display and the washing machine will turn off automatically.
6. The washing machine is now ready for use.

Laundry guidelines

STEP 1: Sort

Sort the laundry according to these criteria:

- Care Label: Sort the laundry into cottons, mixed fibres, synthetics, silks, wools, and rayon.
- Colour: Separate whites from colours.
- Size: Mixing different sized items together in the drum improves the washing performance.
- Sensitivity: Wash delicate items separately for pure, new woollen items, curtains, and silk items. Check the labels on the items.

NOTE: Make sure to check the care label on the clothing, and sort them accordingly before starting the wash.

STEP 2 Empty pockets

- Empty all the pockets of your laundry items
- Metal objects such as coins, pins, and buckles on clothing may damage other laundry items as well as the drum.

Turn clothing with buttons and embroideries inside out

- If trousers or jacket zippers are open while washing, the drum may be damaged. Zippers should be closed and fixed with a string.
- Clothing with long strings may become entangled with other clothes. Make sure to tie the strings before starting the wash.

STEP 3 Use a laundry net

- Brassieres (machine washable) must be placed in a laundry net. Metal parts of the brassieres may break through and tear other laundry items.
- Small, light clothing such as socks, gloves, stockings, and handkerchiefs may become caught around the door. Place them inside a fine laundry net.
- Do not wash the laundry net by itself without other laundry. This may cause abnormal vibrations that could move the washing machine and result in injury.

STEP 4 Prewash (if necessary)

- Select the Prewash option for the selected cycle if the laundry is heavily soiled. When selecting the Prewash option, make sure to put powder-type detergent into the main wash compartment.

STEP 5 Determine the load capacity



- Do not overload the washing machine. Overloading may cause the washing machine to not wash properly. For the load capacity for the type of clothing, see page 35.
- NOTE: When washing bedding or bedding covers, the wash time may be lengthened or the spin efficiency may be reduced. For bedding or bedding covers, the recommended maximum spin cycle speed is 800 rpm, and the load capacity is 2.0 kg or less.
- CAUTION: If the laundry is unbalanced and the "Ub" information code is displayed, redistribute the load. Unbalanced laundry may reduce the spinning performance.

STEP 6 Apply a proper detergent type

The type of detergent depends on the type of fabric (cotton, synthetic, delicate items, wool), colour, wash temperature, and degree of soiling. Make sure to use the laundry detergent that is designed for automatic washing machines.

NOTE

- Follow the detergent manufacturer's recommendations based on the weight of the laundry, the degree of soiling, and the hardness of the water in your local area. If you are not sure about the water hardness, contact a local water authority.
- Do not use detergent that tends to be hardened or solidified. This detergent may remain after the rinse cycle, blocking the drain outlet.

CAUTION: When washing wool using the WOOL  cycle, use only a neutral liquid detergent. If used with the WOOL  cycle, powder detergent may remain on the laundry and discolour the laundry.

Laundry capsules

To get the best results from using laundry capsules, please follow these instructions

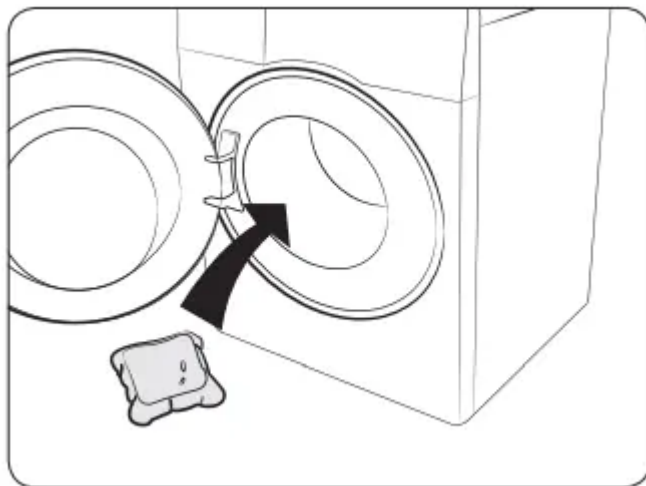

1. Put the capsule in the bottom of the empty drum towards the rear.

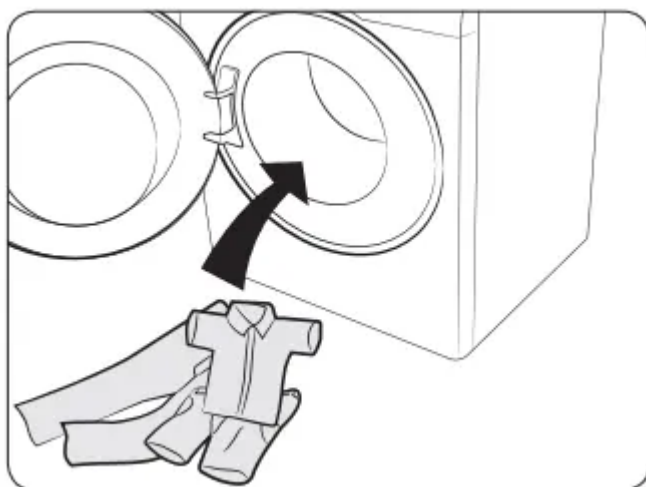

2. Put the laundry in the drum on top of the capsule.

Detergent drawer guidelines

The washing machine provides a three-compartment dispenser: the left compartment for the main wash, the front-right for fabric softeners, and the rear-right for the preliminary wash.

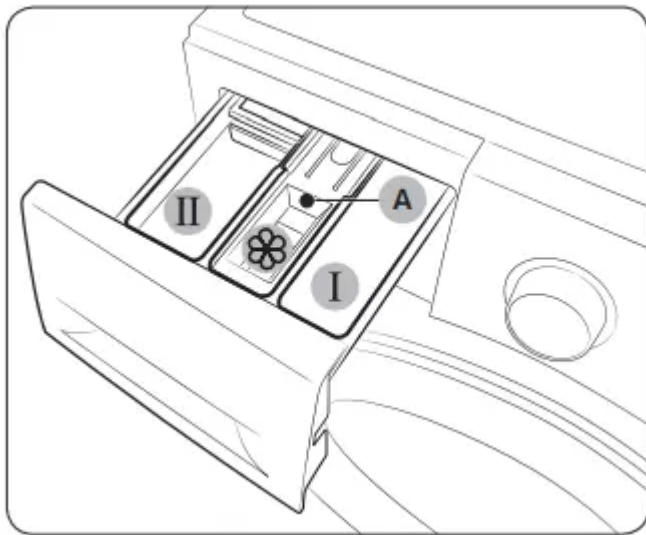

1. **I** Prewash compartment: Apply prewash detergent.
2. **II** Main-wash compartment: Apply main-wash detergent, water softener, soaking detergent, bleach, and/or stain removers.
3.  Softener compartment: Apply additives such as fabric softener. Do not exceed the max line (A).

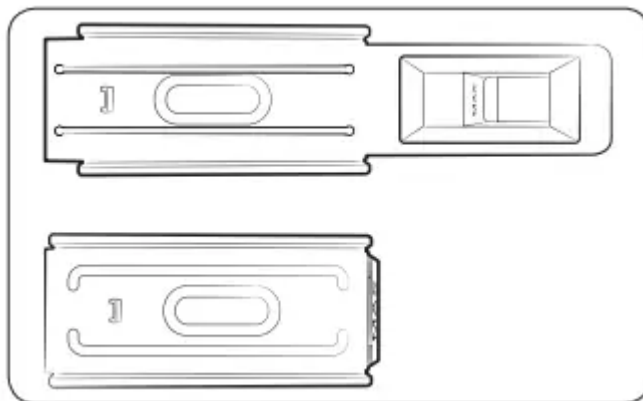



To apply washing agents to the detergent drawer

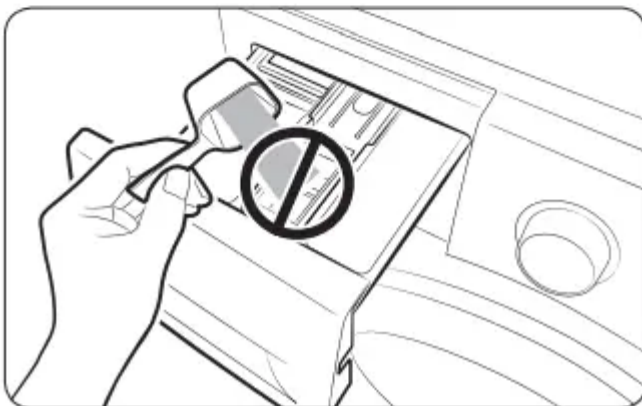

1. Slide open the detergent drawer.
2. Apply laundry detergent to the **II** main-wash compartment as instructed or recommended by the manufacturer. To use liquid detergent, see page 31.



3. Apply fabric softener to the  softener compartment. Do not exceed the max line (A). Softener is dispensed into the wash during the final rinse.

4. If you want to prewash, apply prewash detergent to the  prewash compartment as instructed or recommended by the manufacturer.

5. Close the detergent drawer.

To use liquid detergent (applicable models only)

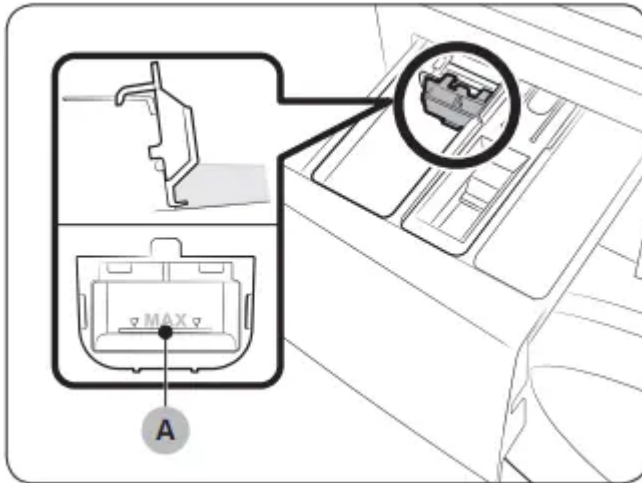

First insert the provided liquid detergent guide in the **II** main-wash compartment. Then, apply liquid detergent to the guide below the marked max line (A).

NOTE

- Insert the liquid detergent guide only after you remove the detergent drawer from the washing machine by pressing release lever (A).
- After a wash, some liquid detergent may remain in the detergent drawer.









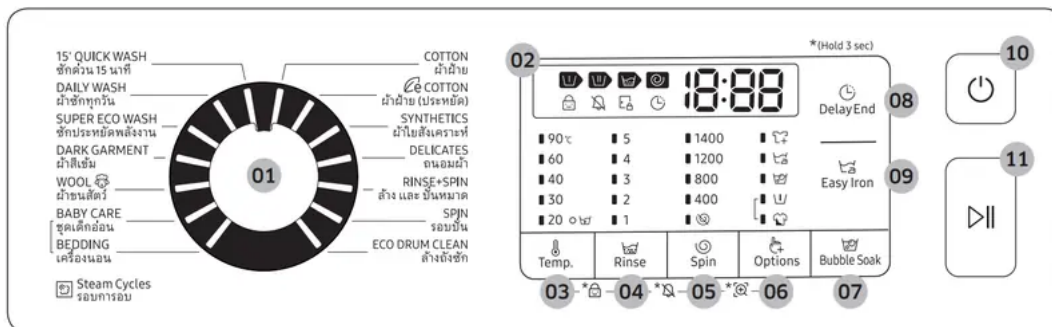

CAUTION





- Do not use the Prewash function when you use liquid detergent.
- Remove the liquid detergent guide when you use powder detergent.

Operations

Control panel



01 Cycle Selector	Turn the dial to select a cycle.
02 Display	The display shows current cycle information and estimated time remaining, or an information code when a problem occurs.
03  Temp.	Press to change the water temperature for the current cycle
04  Rinse	Press to change the rinse count for the current cycle. You can set the rinse count to a max of 5, depending on the cycle.
05  Spin	<p>Press to change the spinning speed for the current cycle. The revolutions per minute (RPM) differs with the model.</p> <ul style="list-style-type: none"> • Rinse Hold: The final rinse process is suspended so that the laundry remains in the water. To unload the laundry, run a drain or spin process. <ul style="list-style-type: none"> ◦ To use the Rinse Hold option, press Spin repeatedly until all the  Spin option indicators turn off. • No Spin : The drum does not rotate after the final drain process. <ul style="list-style-type: none"> ◦ To use the No Spin option, press Spin repeatedly until the No Spin indicator () turns on. • Spin Only : To run the Spin Only cycle, press  Spin for 3 seconds. When the cycle time and spinning speed appear, press  Spin repeatedly until a desired spinning speed is selected. Then, press Start/Pause to start the cycle. The spinning time depends on the selected cycle.
06  Options	<p>Press to select an option from Intensive, and Pre Wash. Press again to deselect.</p> <ul style="list-style-type: none"> • Availability of the options depends on the cycle





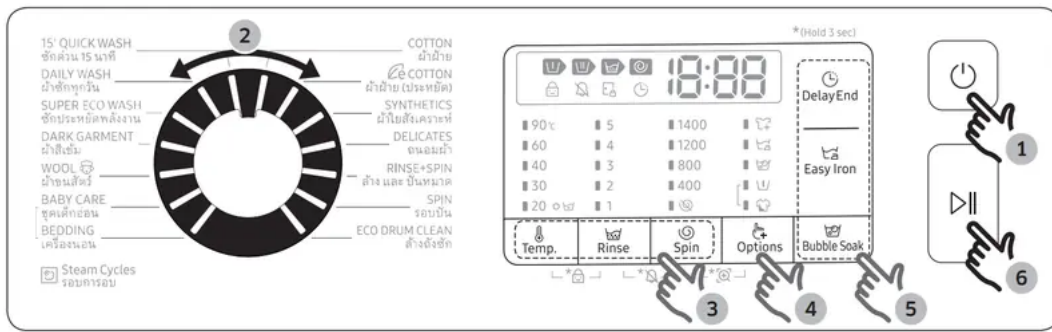

<p>07 </p> <p>Bubble Soak</p>	<p>Press to activate/deactivate the Bubble Soak function. This function helps remove a wide variety of stubborn stains.</p> <ul style="list-style-type: none"> • Bubble Soak helps remove a variety of stubborn stains. • With Bubble Soak selected, laundry is thoroughly soaked in water bubbles for effective washing. • Bubble Soak is available with and adds up to 30 minutes to 5 cycles: COTTON, SYNTHETICS, DAILY WASH, BABY CARE, and BEDDING.
<p>08 </p> <p>Delay End</p>	<p>Delay End lets you set the end time of the current cycle. Based on your settings, the start time of the cycle will be determined by the machine's internal logic. For example, this setting is useful for programming your machine to finish a wash at the time you normally return home from work.</p> <ul style="list-style-type: none"> • Press to choose a preset unit of hours
<p>09 </p> <p>Easy Iron</p>	<p>Press to prepare your laundry so that it can be easily ironed by reducing the wrinkles during the spin cycle.</p> <ul style="list-style-type: none"> • Easy Iron is only available for the following wash cycles: COTTON,  COTTON, SYNTHETICS, DAILY WASH, SUPER ECO WASH, DARK GARMENT, BABY CARE, and BEDDING
<p>10 Power</p>	<p>Press to turn on/off the washing machine.</p>
<p>11 Start/ Pause</p>	<p>Press to start or stop operation.</p>

For more information on the options, see the “Special features” section.

*(Hold 3 sec) : Press and hold for 3 seconds.

Simple steps to start



1. Press Power to turn on the washing machine.
2. Turn the Cycle Selector to select a cycle.
3. Change the cycle settings ( Temp.,  Rinse, and  Spin) as necessary.
4. To add an option, press Options. Use the button again to choose a preferred item.
5. The machine provides 3 respective buttons for  Bubble Soak,  Easy Iron, and  Delay End for easy access. If you want to use one of these options, press the corresponding button.
6. Press Start/Pause



To change the cycle during operation

1. Press Start/Pause to stop operation.
2. Select a different cycle.
3. Press Start/Pause again to start the new cycle.

Cycle overview

Standard cycles

Cycle	Description & Max load (kg)	
COTTON	<ul style="list-style-type: none"> • For cottons, bed linens, table linens, underwear, towels, or shirts. The washing time and the rinse count are automatically adjusted according to the load. 	Max
	<ul style="list-style-type: none"> • Optimal performance with lower energy for cotton fabrics, bed linens, table linens, underwear, towels, or shirts. For energy saving, the actual washing temperature may be lower than specified. 	Max
SYNTHETICS	<ul style="list-style-type: none"> • For blouses or shirts that are made of polyester (diolen, trevira), polyamide (perlon, nylon), or the like. 	4
DELICATES	<ul style="list-style-type: none"> • For sheer fabrics, bras, lingerie (silk), and other handwash-only fabrics. • For best performance, use liquid detergent. 	2
RINSE+SPIN	<ul style="list-style-type: none"> • Featuring an additional rinse process after applying fabric softener to the laundry. 	-
SPIN	<ul style="list-style-type: none"> • Featuring an additional spin process to effectively remove moisture from laundry 	-
ECO DRUM CLEAN	<ul style="list-style-type: none"> • Cleans the drum by removing dirt and bacteria from the drum. • Perform once every 40 washes with no detergent or bleach applied. • Make sure the drum is empty. • Do not use any cleaning agents for cleaning the drum 	-
15' QUICK WASH	<ul style="list-style-type: none"> • For lightly soiled garments that you want to wash quickly. 	2

	<ul style="list-style-type: none"> • Use less than 20 g of detergent. Using more than 20 g of detergent may leave detergent residue 	
DAILY WASH	<ul style="list-style-type: none"> • For everyday items such as underwear and shirts. 	4
SUPER ECO WASH	<ul style="list-style-type: none"> • Low temperature ecobubble cycle helps reduce power consumption. 	4
DARK GARMENT	<ul style="list-style-type: none"> • Featuring additional rinses and reduced spinning to ensure that the laundry is washed gently and rinsed thoroughly. 	4
WOOL 	<ul style="list-style-type: none"> • Specific for machine-washable wool for loads less than 2.0 kg. • The WOOL  cycle features gentle cradling and soaking to protect the wool fibres from shrinkage/ distortion. • A neutral detergent is recommended 	2

Steam cycles

- Steam may not be visible or present during the cycle. This is normal.



BABY CARE	<ul style="list-style-type: none"> • Featuring a high-temperature wash and extra rinses to help remove the remaining detergent effectively 	4
BEDDING	<ul style="list-style-type: none"> • For bed spreads, bed sheets, bedding covers, etc. • For best results, wash only 1 type of bedding and make sure the load weighs less than 2.0 kg. 	2

Options 

Option		Description
	Pre Wash	This will add a preliminary washing cycle before the main wash cycle
	Intensive	For badly soiled laundry. The operation time for each cycle is longer than normal.

Delay End

You can set the washing machine to finish your wash automatically at a later time, choosing a delay of between 1 to 24 hours (in 1 hour increments). The hour displayed indicates the time the wash will finish.

1. Select a cycle. Then change the cycle settings if necessary.
2. Press  Delay End repeatedly until a desired end time is set.
3. Press Start/Pause. The Delay End indicator blinks and the washing machine tumbles the drum to sense the weight of the load if you have selected the COTTON or  COTTON cycle. Load sensing is preset and enabled only in these 2 cycles. When complete, the machine displays your set time and the timer starts ticking.
4. To cancel the  Delay End, restart the washing machine by pressing Power.

Real-life case

- You want to finish a two-hour cycle 3 hours later from now. For this, you add the Delay End option to the current cycle with the 3-hour setting, and press Start/Pause at 2:00 p.m. Then, what happens? The washing machine starts operating at 3:00 p.m., and ends at 5:00 p.m. Provided below is the time line for this example.

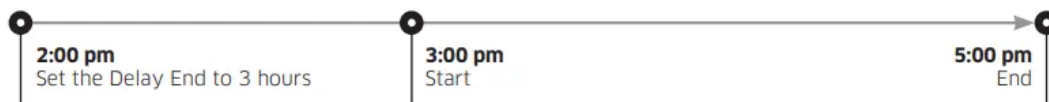

Special features

AddWash

When the AddWash indicator  is on, you can stop operation of the machine and put additional laundry or softener into the drum. The Add Door opens by more than 130° for easy access.

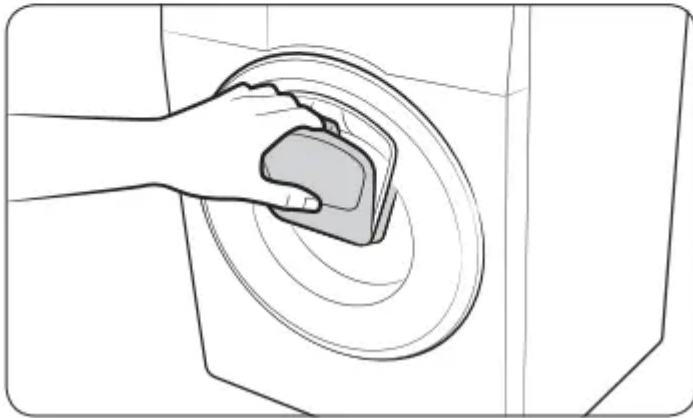





1. Press Start/Pause to stop operation.
2. Press the upper area of the Add Door until you hear a clicking sound to unlock. Pull the handle of the Add Door to open.
3. Open the Add Door and put additional laundry or softener into the drum.
4. Push the Add Door until you hear a clicking sound to close.
5. Press Start/Pause to resume operation.

Settings



Child Lock

To prevent accidents by children, Child Lock locks all buttons except for Power.

- To set the Child Lock function, hold down  Temp. and  Rinse simultaneously for 3 seconds.
- To release the Child Lock function, hold down  Temp. and  Rinse simultaneously for 3 seconds.

Sound On/Off

You can turn on or off the sound from the washing machine. When this function is set to Off, the AddWash alarm, the melody of cycle completion, and the power-off beep will not sound. However, the other sounds stay active.

- To mute the sound, press and hold  Rinse and  Spin for 3 seconds.
- To unmute the sound, press and hold again for 3 seconds.
- Your setting will be kept even after restarting the machine.

Maintenance

Keep the washing machine clean to prevent deteriorated performance and to preserve its life cycle.

Eco drum clean

Perform this cycle regularly to clean the drum and to remove bacteria from it.

1. Press Power to turn on the washing machine.
2. Turn the Cycle Selector to select ECO DRUM CLEAN.
3. Press Start/Pause.

NOTE

- The water temperature for ECO DRUM CLEAN is set to 70 °C, which cannot be changed.
- It is recommended to run the ECO DRUM CLEAN cycle once every 40 washes.

CAUTION: Do not use any cleaning agents for cleaning the drum. Chemical residue in the drum deteriorates the washing performance.

ECO DRUM CLEAN reminder

- The ECO DRUM CLEAN reminder appears on the main screen once every 40 washes. It is advisable to perform the ECO DRUM CLEAN regularly.
- When you first see this reminder, you can ignore the reminder for 6 consecutive washes. From the 7th wash, the reminder no longer appears. However, it appears again on the next 40th wash.

Smart Check

To enable this function, you must first download the Samsung Smart Washer app at the Play Store or the App Store, and install it on a mobile device featuring a camera function.

The Smart Check function has been optimized for Galaxy & iPhone series (applicable models only).

1. When the washing machine detects an issue to check, it enters Smart Check mode after powering on.
2. The washing machine starts the self-diagnosis procedure and displays an information code if a problem is detected.
3. Run the Samsung Smart Washer app on your mobile device, and tap Smart Check.
4. Put the mobile device close to the washing machine's display so that the smartphone camera and the washing machine face each other. Then, the information code will be recognized automatically by the app.
5. When the information code is recognized correctly, the app provides detailed information about the problem with applicable solutions.

NOTE

- The function name, Smart Check, may differ depending on the language.
- If there is strong reflected light on the washing machine display, the app may fail to recognize the information code.
- If the app fails to recognize the Smart Check code consecutively, enter the information code manually onto the app screen.

Emergency drain

In case of a power failure, drain the water inside the drum before taking out the laundry.

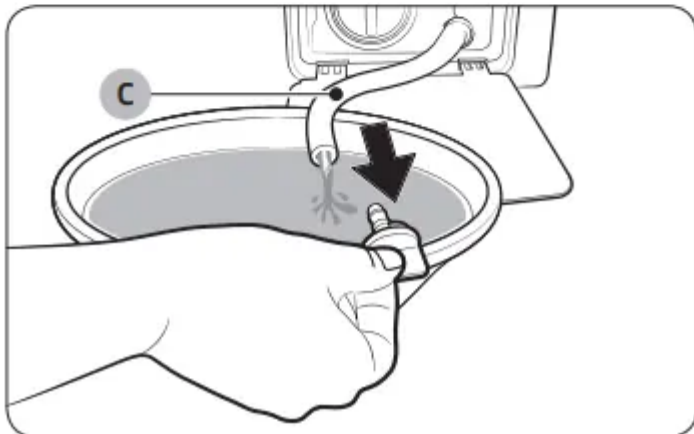
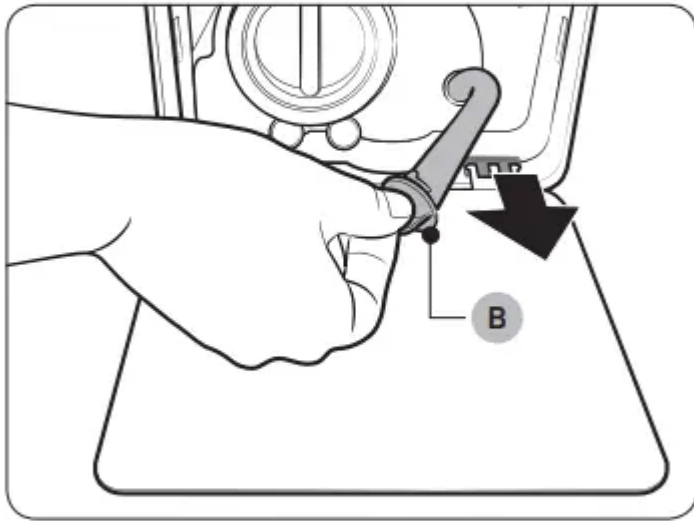
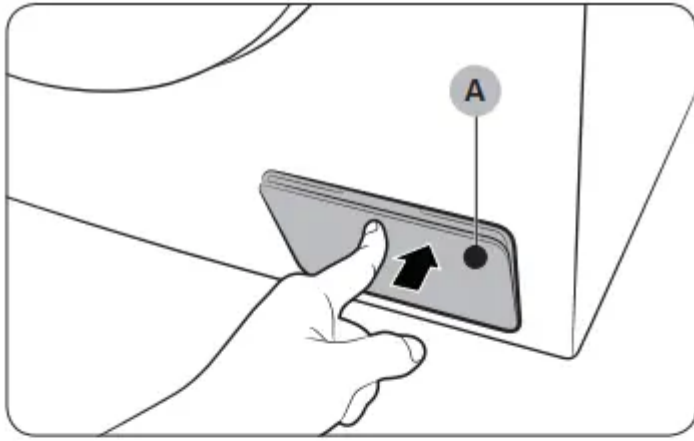

1. Power off and unplug the washing machine from the electrical outlet.
2. Gently press the top area of the filter cover (A) to open.
3. Put an empty, spacious container around the cover, and stretch the emergency drain tube to the container while holding the tube cap (B).
4. Open the tube cap and let water in the emergency drain tube (C) flow into the container.
5. When done, close the tube cap, and reinsert the tube. Then, close the filter cover.

NOTE: Use a spacious container because the water in the drum may be more than expected

Cleaning

Surface of the washing machine

- Use a soft cloth with a nonabrasive household detergent. Do not spray water onto the washing machine.

Add Door



1. Open the Add Door.
2. Use a wet cloth to clean the Add Door.
 - Do not use cleaning agents. Discolouration may occur.
 - Use caution when cleaning the rubber packing and the locking mechanism (A).
 - Dust off the door area regularly.
3. Wipe up and close the Add Door until you hear a clicking sound.

CAUTION

- Do not apply force on the Add Door. It may break.
- Do not leave the Add Door open while the machine is operating.
- Do not put heavy objects on the Add Door at any time.
- To prevent physical injury, do not touch the Add Door while the drum is rotating.
- Do not open the Add Door while the machine is operating. This may cause physical injury.
- Do not manipulate the feature panel while the Add Door is open. This may cause physical injury or system failure.
- Do not input objects other than laundry.
- Do not input bulky items to the drum through the Add Door.

- Do not pull out the rubber packing of the Add Door when cleaning. This may cause damage.

Mesh filter

Clean the mesh filter of the water hose once or twice a year.

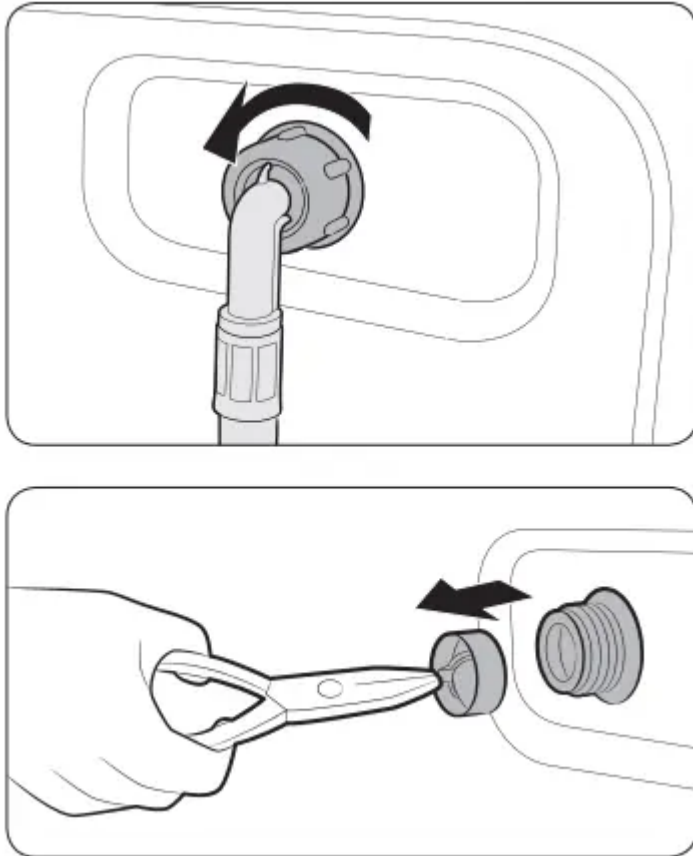

1. Turn off the washing machine, and unplug the power cord.
2. Close the water tap
3. Loosen and disconnect the water hose from the back of the washing machine. Cover the hose with a cloth to prevent water from gushing out.
4. Use pliers to pull out the mesh filter from the inlet valve.
5. Submerge the mesh filter deeply in water so that the threaded connector is also submerged.
6. Dry the mesh filter completely in the shade.
7. Reinsert the mesh filter into the inlet valve, and reconnect the water hose to the inlet valve.
8. Open the water tap

NOTE: If the mesh filter is clogged, an information code of “4C” appears on the screen.

Pump filter

It is advisable to clean the pump filter 5 or 6 times a year to prevent its clogging. A clogged pump filter may reduce the bubble effect.

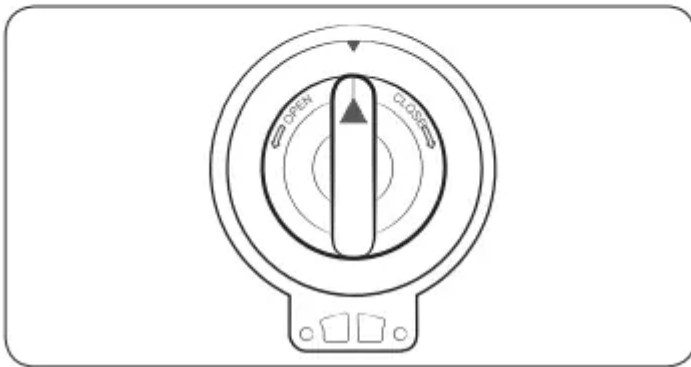
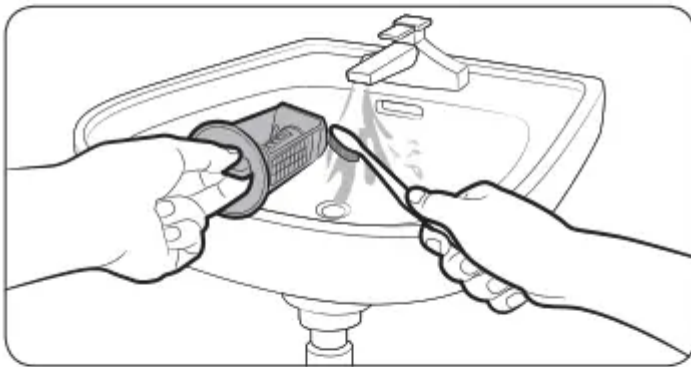
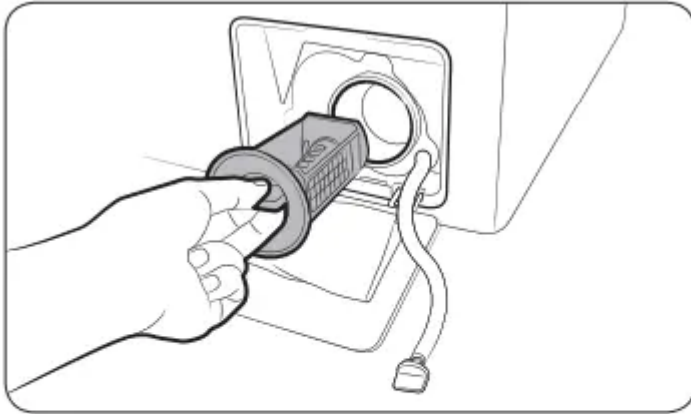

1. Turn off the washing machine, and unplug the power cord.
2. Drain the remaining water inside the drum. See the “Emergency drain” section.
3. Gently press the top area of the filter cover to open.
4. Turn the pump filter knob to the left, and drain off the remaining water.
5. Clean the pump filter using soft brushes. Make sure the drain pump propeller inside the filter is unclogged.
6. Reinsert the pump filter, and turn the filter knob to the right.

NOTE: If the pump filter is clogged, an information code of “5C” appears on the screen.

CAUTION

- Make sure the filter knob is closed properly after cleaning the filter. Otherwise, this may cause a leak.
- Make sure the filter is inserted properly after cleaning it. Otherwise, this may cause an operational failure or a leak

Detergent drawer

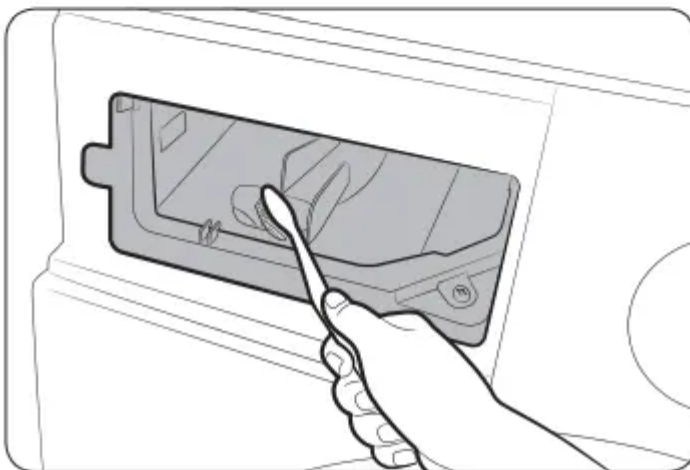
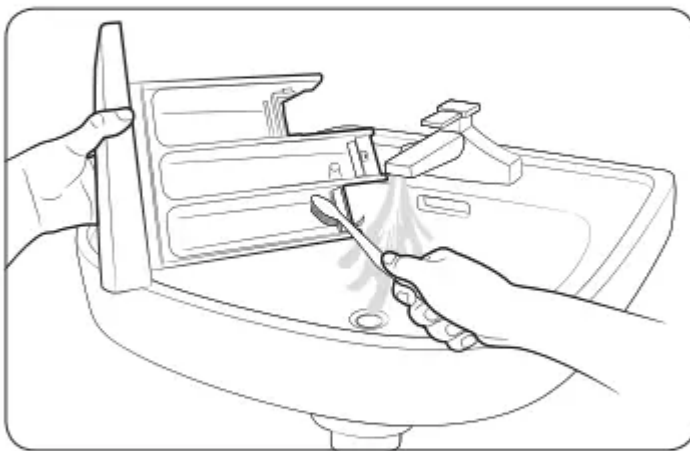
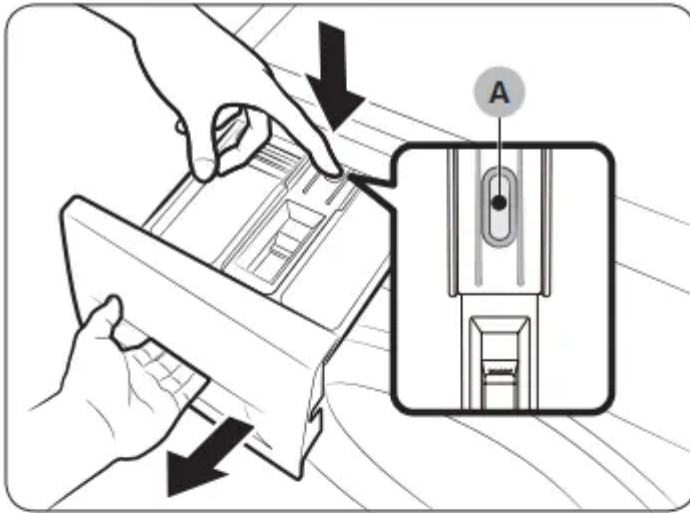

1. While holding down the release lever (A) inside the drawer, slide open the drawer.
2. Remove the release lever and the liquid detergent guide from the drawer.
3. Clean the drawer components in flowing water using a soft brush.
4. Clean the drawer recess using a soft brush.
5. Reinsert the release lever and the liquid detergent guide to the drawer.
6. Slide the drawer inward to close it.

NOTE: To remove remaining detergent, perform the RINSE+SPIN cycle with the drum being empty.

Recovery from freezing

The washing machine may freeze when it drops below 0 °C.

1. Turn off the washing machine, and unplug the power cord.
2. Pour warm water over the water tap to loosen the water hose.
3. Disconnect the water hose, and soak it in warm water.
4. Pour warm water into the drum and leave it for about 10 minutes.
5. Reconnect the water hose to the water tap.

NOTE: If the washing machine still doesn't operate normally, repeat the above steps until it operates normally.

Care against an extended time of disuse

Avoid leaving the washing machine unused for an extended time. If this is the case, drain the washing machine and unplug the power cord.

1. Turn the Cycle Selector to select RINSE+SPIN.
2. Empty the drum, and press Start/Pause.
3. When the cycle is complete, close the water tap and disconnect the water hose.
4. Turn off the washing machine, and unplug the power cord.
5. Open the door to let air circulate through the drum.

Troubleshooting

Checkpoints

If you encounter a problem with the washing machine, first check the table below and try the suggestions.

Problem	Action
Does not start.	<ul style="list-style-type: none"> • Make sure the washing machine is plugged in. • Make sure the door is properly closed. • Make sure the water taps are open. • Press or tap Start/Pause to start the washing machine. • Make sure Child Lock is not activated. • Before the washing machine starts to fill, it will make a series of clicking noises to check the door lock and does a quick drain. • Check the fuse or reset the circuit breaker.
Water supply is insufficient, or no water is supplied.	<ul style="list-style-type: none"> • Fully open the water tap. • Make sure the door is properly closed. • Make sure the water supply hose is not frozen. • Make sure the water supply hose is not kinked or clogged. • Make sure there is sufficient water pressure.
After a cycle, detergent remains in the detergent drawer.	<ul style="list-style-type: none"> • Make sure the washing machine is running with sufficient water pressure. • Make sure the detergent is added to the centre of the detergent drawer. • Make sure the rinse cap is inserted properly. • If using granular detergent, make sure the detergent selector is in the upper position. • Remove the rinse cap and clean the detergent drawer.

<p>Excessive vibrations or makes noise.</p>	<ul style="list-style-type: none"> • Make sure the washing machine is installed on a level, solid floor that is not slippery. If the floor is not level, use the levelling feet to adjust the height of the washing machine. • Make sure the shipping bolts are removed. • Make sure the washing machine is not contacting any other object. • Make sure the laundry load is balanced. • The motor can cause noise during normal operation. • Overalls or metal-decorated clothes can cause noise while being washed. This is normal. • Metal objects such as coins can cause noise. After washing, remove these objects from the drum or filter case.
<p>Does not drain and/ or spin.</p>	<ul style="list-style-type: none"> • Make sure the drain hose is straightened all the way to the drain system. If you encounter a drain restriction, call for service. • Make sure the debris filter is not clogged. • Close the door and press or tap Start/Pause. For your safety, the washing machine will not tumble or spin unless the door is closed. • Make sure the drain hose is not frozen or clogged. • Make sure the drain hose is connected to a drain system that is not clogged. • If the washing machine is not supplied with sufficient power, the washing machine temporarily will not drain or spin. As soon as the washing machine regains sufficient power, it will operate normally.
<p>The door does not open.</p>	<ul style="list-style-type: none"> • Press or tap Start/Pause to stop the washing machine. • It may take a few moments for the door lock mechanism to disengage. • The door will not open until 3 minutes after the washing machine has stopped or the power turned off. • Make sure all the water in the drum is drained. • The door may not open if water remains in the drum. Drain the drum and open the door manually. • Make sure the door lock light is off. The door lock light turns off after the washing machine has drained.



Excessive suds.	<ul style="list-style-type: none"> • Make sure you use the recommended types of detergent as appropriate. • Use high efficiency (HE) detergent to prevent oversudsing. • Reduce the detergent amount for soft water, small loads, or lightly soiled loads. • Non-HE detergent is not recommended.
Cannot apply additional detergent.	<ul style="list-style-type: none"> • Make sure the remaining amount of detergent and fabric softener is not over the limit.
Stops	<ul style="list-style-type: none"> • Plug the power cord into a live electrical outlet. • Check the fuse or reset the circuit breaker. • Close the door and press Start/Pause to start the washing machine. For your safety, the washing machine will not tumble or spin unless the door is closed. • Before the washing machine starts to fill, it will make a series of clicking noises to check the door lock and does a quick drain. • There may be a pause or soak period in the cycle. Wait briefly and the washing machine may start. • Make sure the mesh filter of the water supply hose at the water taps is not clogged. Periodically clean the mesh filter. • If the washing machine is not supplied with sufficient power, the washing machine temporarily will not drain or spin. As soon as the washing machine regains sufficient power, it will operate normally.
Fills with the wrong water temperature.	<ul style="list-style-type: none"> • Fully open both taps. • Make sure the temperature selection is correct. • Make sure the hoses are connected to the correct taps. Flush water lines. • Make sure the water heater is set to supply a minimum 120 °F (49 °C) hot water at the tap. Also, check the water heater capacity and recovery rate. • Disconnect the hoses and clean the mesh filter. The mesh filter may be clogged. • While the washing machine fills, the water temperature may change as the automatic temperature control feature checks incoming water temperature. This is normal.

	<ul style="list-style-type: none"> • While the washing machine fills, you may notice just hot and/ or just cold water going through the dispenser when cold or warm temperatures are selected. This is a normal function of the automatic temperature control feature as the washing machine determines the water temperature.
Load is wet at the end of a cycle.	<ul style="list-style-type: none"> • Use the High or Extra High spin speed. • Use high efficiency (HE) detergent to reduce oversudsing. • Load is too small. Small loads (one or two items) may become unbalanced and not spin completely. • Make sure the drain hose is not kinked or clogged.
Leaks water.	<ul style="list-style-type: none"> • Make sure the door is properly closed. • Make sure all hose connections are tight. • Make sure the end of the drain hose is correctly inserted and secured to the drain system. • Avoid overloading. • Use high efficiency (HE) detergent to prevent oversudsing.
Has odours.	<ul style="list-style-type: none"> • Excessive suds collect in recesses and can cause foul odours. • Run cleansing cycles to sanitize periodically. • Clean the door seal (diaphragm). • Dry the washing machine interior after a cycle has finished.
No bubbles are seen (Bubbleshot models only).	<ul style="list-style-type: none"> • Overloading may screen bubbles. • Severely contaminated laundry may not generate bubbles.

Can I open the Add Door at any time?	<p>The Add Door can be opened only when the indicator appears. However, it does not open in the following cases:</p> <ul style="list-style-type: none">• When the boiling or drying process is running and the internal temperature becomes high.• If you set the Child Lock for safety reasons.• When the drum wash or drum drying cycle is running that does not involve additional laundry.
--------------------------------------	--

If a problem persists, contact a local Samsung service centre.

Information codes

If the washing machine fails to operate, you may see an information code on the screen. Check the table below and try the suggestions.

Code	Action
4C	<p>Water is not supplied.</p> <ul style="list-style-type: none"> • Make sure the water taps are open. • Make sure the water hoses are not clogged. • Make sure the water taps are not frozen. • Make sure the washing machine is operating with sufficient water pressure. • Make sure that the cold water tap and the hot water tap are properly connected. • Clean the mesh filter as it may be clogged.
4C2	<ul style="list-style-type: none"> • Make sure the cold water supply hose is firmly connected to the cold water tap. If it is connected to the hot water tap, the laundry may be deformed with some cycles.
5C	<p>Water is not draining.</p> <ul style="list-style-type: none"> • Make sure the drain hose is not frozen or clogged. • Make sure the drain hose is positioned correctly, depending on the connection type. • Clean the debris filter as it may be clogged. • Make sure the drain hose is straightened all the way to the drain system. • If the information code remains, contact a customer service centre.
dC	<p>Operating the washer with the door open.</p> <ul style="list-style-type: none"> • Make sure the door is properly closed. • Make sure laundry is not caught in the door.
OC	<p>Water has overflowed.</p> <ul style="list-style-type: none"> • Restart after spinning. • If the information code remains on the display, contact a local Samsung service centre.

LC, LC1	<p>Check the drain hose.</p> <ul style="list-style-type: none"> • Make sure the end of the drain hose is not placed on the floor. • Make sure the drain hose is not clogged. • If the information code remains, contact a customer service centre.
Ub	<p>Spinning does not work.</p> <ul style="list-style-type: none"> • Make sure laundry is spread out evenly. • Make sure the washing machine is on a flat, stable surface. • Redistribute the load. If only one item of clothing needs washing, such as a bathrobe or pair of jeans, the final spin result might be unsatisfactory, and an “Ub” check message will be shown in the display.
3C	<p>Check the motor for operation.</p> <ul style="list-style-type: none"> • Try restarting the cycle. • If the information code remains, contact a customer service centre.
UC	<p>The electronic control needs to be checked.</p> <ul style="list-style-type: none"> • Check if power is supplied properly. • If the information code remains, contact a customer service centre.
	<p>Low voltage detected.</p> <ul style="list-style-type: none"> • Check if the power cord is plugged in. • If the information code remains, contact a customer service centre.
HC	<p>High temperature heating check.</p> <ul style="list-style-type: none"> • If the information code remains, contact a customer service centre.
1C	<p>The Water Level sensor is not working properly.</p> <ul style="list-style-type: none"> • Turn the machine off, and restart the cycle. • If the information code remains, contact a customer service centre.

AC	<p>Check communications between main and sub PBAs.</p> <ul style="list-style-type: none"> • Turn the machine off, and restart the cycle. • If the information code remains, contact a customer service centre.
DDC, ddC	<p>This message appears when you open the Add Door without pressing Start/Pause. If this happens, do one of the following:</p> <ul style="list-style-type: none"> • Press the Add Door to close properly. Then, press Start/Pause and try again. • To add laundry, open the Add Door and input laundry. Close the Add Door properly. Then, press Start/Pause to resume operation.
8C	<p>The MEMS sensor is not working properly.</p> <ul style="list-style-type: none"> • Turn the machine off, and restart the cycle. • If the information code remains, contact a local Samsung service centre.
AC6	<p>Check communications between the main and the inverter PBAs.</p> <ul style="list-style-type: none"> • Depending on the state, the machine may automatically returns to normal operation. • Turn the machine off, and restart the cycle. • If the information code remains, contact a local Samsung service centre.
DC1	<p>The Main Door lock/unlock is not working properly.</p> <ul style="list-style-type: none"> • Turn the machine off, and restart the cycle. • If the information code remains, contact a local Samsung service centre.
DC3	<p>The Add Door lock/unlock is not working properly.</p> <ul style="list-style-type: none"> • Turn the machine off, and restart the cycle. • If the information code remains, contact a local Samsung service centre.

Warning

This content is compiled from multiple sources and is provided for reference purposes only. It may not be complete or fully applicable to all situations. If you are unable to resolve your issue, please contact the product manufacturer or an authorized service provider for official support.

Document generated by [ManualsFile](#)

