

Operating Instructions

Using the gas surface burners

Before Lighting a Gas Burner

- Make sure all burners are in place.
- Make sure all grates on the range are properly placed before using any burner.
- If your range has the Gas/Control Lockout feature, make sure it is disabled before attempting to light the surface burners.

After Lighting a Gas Burner

- Do not operate the burner for an extended period of time without cookware on the grate. The finish on the grate may chip without cookware to absorb the heat.
- Be sure the burners and grates are cool before you place your hand, a pot holder, cleaning cloths or other materials on them.

How to Light a Gas Surface Burner



Push the control knob in and turn it to the **LITE** position.

Make sure all the surface burners are placed in their respective positions.

Push the control knob in and turn it to the LITE position.

You will hear a little clicking noise—the sound of the electric spark igniting the burner.

Turn the knob to adjust the flame size.

If the knob stays at LITE, it will continue to click.

When one burner is turned to LITE, all the burners spark. Do not attempt to disassemble or clean around any burner while another burner is on. An electric shock may result, which could cause you to knock over hot cookware.

Sealed Gas Burners

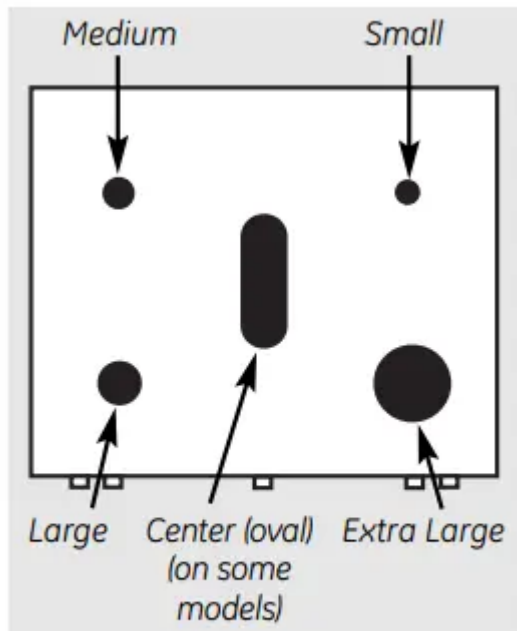

Your gas range cooktop has five sealed gas burners. They offer convenience, cleanability and flexibility to be used in a wide range of cooking applications.

The smallest burner in the right rear position is the simmer burner. This burner can be turned down to LO for a very low simmer setting. It provides precise cooking performance for delicate foods such as sauces or foods that require low heat for a long cooking time.

The medium (left rear) and the large (left front) burners are the primary burners for most cooking. These general-purpose burners can be turned down from HI to LO to suit a wide range of cooking needs.

The extra large burner (right front) is the maximum output burner. Like the other four burners, it can be turned down from HI to LO for a wide range of cooking applications; however, this burner is designed to quickly bring large amounts of liquid to a boil. It has a special **POWER BOIL™** setting designed to be used with cookware 12 inches or larger in diameter.



Extra-large burner only

The center oval burner (on some models) is for large pots/pans or for use with the griddle.

How to Select Flame Size

For safe handling of cookware, never let the flames extend up the sides of the cookware.



Watch the flame, not the knob, as you reduce heat. When fast heating is desired, the flame size on a gas burner should match the cookware you are using.

Flames larger than the bottom of the cookware will not result in faster heating of the cookware and could be hazardous.

Top-of-Range Cookware

Aluminum: Medium-weight cookware is recommended because it heats quickly and evenly. Most foods brown evenly in an aluminum skillet. Use saucepans with tightfitting lids when cooking with minimum amounts of water.

Cast-Iron: If heated slowly, most skillets will give satisfactory results.

Enamelware: Under some conditions, the enamel of some cookware may melt. Follow cookware manufacturer's recommendations for cooking methods.

Glass: There are two types of glass cookware—those for oven use only and those for top-of-range cooking (saucepans, coffee and teapots). Glass conducts heat very slowly.

Heatproof Glass Ceramic: Can be used for either surface or oven cooking. It conducts heat very slowly and cools very slowly. Check cookware manufacturer's directions to be sure it can be used on gas ranges.

Stainless Steel: This metal alone has poor heating properties and is usually combined with copper, aluminum or other metals for improved heat distribution. Combination metal skillets usually work satisfactorily if they are used with medium heat as the manufacturer recommends.

Stove Top Grills

Do not use stove top grills on your sealed gas burners. If you use the stove top grill on the sealed gas burner, it will cause incomplete combustion and can result in exposure to carbon monoxide levels above allowable current standards.



This can be hazardous to your health.

Wok This Way

We recommend that you use a 14" or smaller flat-bottomed wok. Make sure the wok bottom sits flat on the grate. They are available at your local retail store.



Only a flat-bottomed wok should be used.

Do not use a flat-bottomed wok on a support ring. Placing the ring over the burner or grate may cause the burner to work improperly, resulting in carbon monoxide levels above allowable standards. This could be dangerous to your health.



In Case of Power Failure

In case of a power failure, you can light the gas surface burners on your range with a match. Hold a lit match to the burner, then push in and turn the control knob to the Lite position. Use extreme caution when lighting burners this way.

Surface burners in use when an electrical power failure occurs will continue to operate normally.

Using the griddle.



Your non-stick coated griddle provides an extra-large cooking surface for meats, pancakes or other food usually prepared in a frying pan or skillet.

NOTE: Your griddle will discolor over time as it becomes seasoned with use.

How to Insert the Griddle



CAUTION: Place and remove the griddle only when all grates and griddle are cool and all surface units are turned OFF.

The griddle can only be used with the center burner. To insert the griddle, remove the center grate and replace with the griddle.

Using the Griddle

Most griddled foods require cooking on a preheated surface. Preheat griddle according to the guide below, then switch to the desired cook setting

Type of Food	Preheat Conditions	Cook Setting
Warming Tortillas	none	3 (MED-LOW)
Pancakes	7 (MED-HI) 3 min.	7 (MED-HI)
Hamburgers	7 (MED-HI) 5 min.	7 (MED-HI)
Fried Eggs	HI 5 min.	4 (MED)
Bacon	none	5 (MED)
Breakfast Sausage Links	HI 5 min.	5 (MED)
Hot Sandwiches (such as Grilled Cheese)	HI 4 min.	HI

NOTE: Griddle settings may need to be adjusted if the griddle is used for an extended time.



5. Proof Pad (on some models)

Touch to select a warm environment useful for rising yeast-leavened products.

6. Start Pad

Must be touched to start any cooking or cleaning function.

7. Display

Shows the time of day, oven temperature, whether the oven is in the bake, broil or self-cleaning mode, the times set for the timer or automatic oven operations, and if the range is locked.

If “F– and a number or letter” flash in the display and the oven control signals, this indicates a function error code. Touch the Clear/Off pad. Allow the oven to cool for one hour. Put the oven back into operation. If the function error code repeats, disconnect the power to the oven and call for service.

If your oven was set for a timed oven operation and a power outage occurred, the clock and all programmed functions must be reset.

The time of day will flash in the display when there has been a power outage.

8. Self Clean Pad

Touch to select self-cleaning function. See the Using the self-cleaning oven section.

9. Oven Light On/Off Pad

Touch to turn the oven light on or off.

10. Delay Start Pad

Use along with Cooking Time or Self Clean pads to set the oven to start and stop automatically at a time you set.

11. Cooking Time Pad

Touch and then touch the number pads to set the amount of time you want your food to cook.

The oven will shut off when the cooking time has run out.

12. Clear/Off Pad

Touch to cancel ALL oven operations except the clock, timer and Control Lockout.

13. Clock Pad

Touch before setting the clock.

14. Number Pads

Use to set any function requiring numbers, such as the time of day on the clock, the timer, the oven temperature, the internal food temperature, the start time and length of operation for timed baking and self-cleaning.

15. Kitchen Timer On/Off Pad

Touch to select the timer feature.

16. Control Lockout (on some models)

The control lockout is 9 and 0. Touch and hold the 9 and 0 pads at the same time for 3 seconds.

NOTE: Some models have a Control Lockout pad.

17. Warming Drawer On/Off Pad (on some models)

Touch this pad and then touch number pads 1–3 to use the warming drawer. See the Using the electric warming drawer section.

NOTE: On models with backlit touch pad controls, they will remain lit for many minutes after they are last touched.



Features, appearance and pad locations may vary.

Oven Control, Clock, Timer and Features (on some models)

1. Bake Pad

Touch to select the bake function.

2. Broil Hi/Lo Pad

Touch to select the broil function.

3. Convection Bake Multi/1 Rack Pad (on some models)

Touch to select baking with the convection function.

4. Convection Roast Pad (on some models)

Touch to select roasting with the convection function.

5. Start Pad

Must be touched to start any cooking or cleaning function.

6. Display

Shows the time of day, oven temperature, whether the oven is in the bake, broil or self-cleaning mode, the times set for the timer or automatic oven operations, and if the range is locked.

If “F– and a number or letter” flash in the display and the oven control signals, this indicates a function error code. Touch the Clear/Off pad. Allow the oven to cool for one hour. Put the oven back into operation. If the function error code repeats, disconnect the power to the oven and call for service.

If your oven was set for a timed oven operation and a power outage occurred, the clock and all programmed functions must be reset.

The time of day will flash in the display when there has been a power outage.

7. Self-Clean Pad

Touch to select self-cleaning function. See the Using the self-cleaning oven section.

8. Oven Light On/Off Pad

Touch to turn the oven light on or off.

9. Delay Start Pad

Use along with Cooking Time or Self Clean pads to set the oven to start and stop automatically at a time you set.

10. Cooking Time Pad

Touch and then touch the number pads to set the amount of time you want your food to cook.

The oven will shut off when the cooking time has run out.

11. Clear/Off Pad

Touch to cancel ALL oven operations except the clock, timer and Gas/Control Lockout or Control Lockout (depending on model).

12. Clock Pad

Touch before setting the clock.

13. Number Pads

Use to set any function requiring numbers, such as the time of day on the clock, the timer, the oven temperature, the internal food temperature, the start time and length of operation for timed baking and self-cleaning.

14. Kitchen Timer On/Off Pad

Touch to select the timer feature.

15. Probe Pad

Touch when using the probe to cook food.

16. Gas/Control Lockout Pad (on some models)

Touch and hold the Gas/Control Lockout pad for 3 seconds to lock/unlock the surface burners, oven burners and control panel so they cannot be activated.

17. Control Lockout (on some models)

The control lockout is 9 and 0. Touch and hold the 9 and 0 pads at the same time for 3 seconds.

18. Warming Drawer On/Off Pad (on some models)

Touch this pad and then touch number pads 1–3 to use the warming drawer. See the Using the electric warming drawer section.

Using the upper oven

To avoid possible burns, place the racks in the desired position before you turn the oven on.

Before you begin...

The oven has 5 rack positions.

It also has a special low rack position (R) for extra large items, such as a large turkey.



The shelves have stop-locks, so that when placed correctly on the shelf supports (A through E), they will stop before coming completely out, and will not tilt.

When placing and removing cookware, pull the shelf out to the bump on the shelf support.

To remove a rack, pull it toward you, tilt the front end up and pull it out.

To replace, place the end of the rack (stoplocks) on the support, tilt up the front and push the rack in.

NOTE: The shelf is not designed to slide out at the special low shelf (R) position.

Upper Oven Vent

Plastic items on the cooktop may melt if left too close to the vent.

Vent appearance and location vary.



Your oven is vented through ducts at the rear of the range. Do not block these ducts when cooking in the oven—it is important that the flow of hot air from the oven and fresh air to the oven burner be uninterrupted. Avoid touching the vent openings or nearby surfaces during oven or broiler operation—they may become hot.

- Handles of pots and pans on the cooktop may become hot if left too close to the vent.
- Do not leave plastic or flammable items on the cooktop—they may melt or ignite if left too close to the vent.
- Do not leave closed containers on the cooktop. The pressure in closed containers may increase, which may cause them to burst.
- Metal items will become very hot if they are left on the cooktop, and could cause burns.

Power Outage

CAUTION: Do not make any attempt to operate the electric ignition oven during an electrical power failure.

The oven or broiler cannot be lit during a power failure. Gas will not flow unless the glow bar is hot.

If the oven is in use when a power failure occurs, the oven burner shuts off and cannot be re-lit until power is restored. This is because the flow of gas is automatically stopped and will not resume when power is restored until the glow bar has reached operating temperature.

Upper Oven Light

Touch the Oven Light pad on the upper control panel to turn the light on or off.

On some models, the Oven Light switch is on the lower front control panel.

How to Set the Oven for Baking or Roasting

The oven has a special low rack (R) position just above the oven bottom. Use it when extra cooking space is needed, for example, when cooking a large turkey. The rack is not designed to slide out at this position.

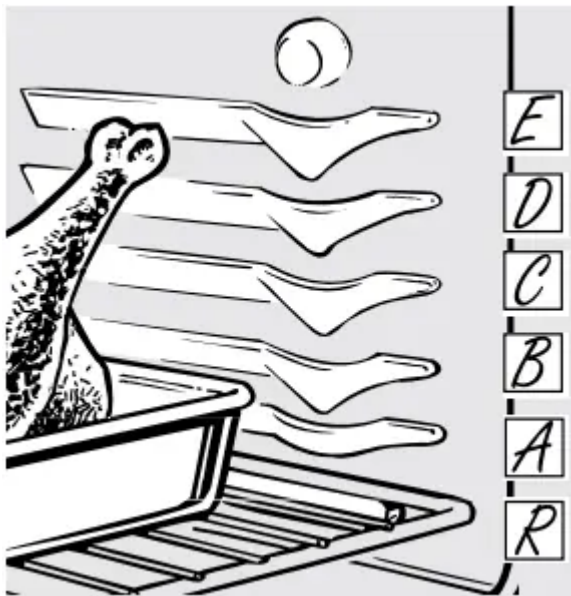

Your oven is not designed for open-door cooking.

1. Touch the **Bake** pad.
2. Touch the number pads to set the desired temperature
3. Touch the **Start** pad.

The oven will start automatically. The display will show PRE while preheating. When the oven reaches the selected temperature, the oven control will beep several times and the display will show the oven temperature.

To change the oven temperature during Bake cycle, touch the **Bake** pad and then the number pads to get the new temperature.

4. Check food for doneness at minimum time on recipe. Cook longer if necessary.
5. Touch the Clear/Off pad when baking is finished and then remove the food from the oven.

Type of Food	Shelf Position
Frozen pies (on cookie sheet)	B or C
Angel food cake, bundt or pound cakes	A
Biscuits, muffins, brownies, cookies, cupcakes, layer cakes, pies	C
Casseroles	B or C
Roasting	R or A

Preheating and Pan Placement

Preheat the oven if the recipe calls for it. To preheat, set the oven at the correct temperature. Preheating is necessary for good results when baking cakes, cookies, pastry and breads.

For ovens without a preheat indicator light or tone, preheat 10 minutes.

Baking results will be better if baking pans are centered in the oven as much as possible. Pans should not touch each other or the walls of the oven. If you need to use two racks, stagger the pans so one is not directly above the other, and leave approximately 1 1/2" between pans, from the front, back and sides of the wall.

Aluminum Foil

Do not use aluminum foil on the bottom of the oven.

Never entirely cover a rack with aluminum foil. This will disturb the heat circulation and result in poor baking.

A smaller sheet of foil may be used to catch a spillover by placing it on a lower rack several inches below the food.

Oven Moisture

As your oven heats up, the temperature change of the air in the oven may cause water droplets to form on the door glass. These droplets are harmless and will evaporate as the oven continues to heat up.

If your model has a door latch, do not lock the oven door with the latch during broiling. The latch is used for self-cleaning only.

How to Set the Upper Oven for Broiling

Close the door. Always broil with the door closed.

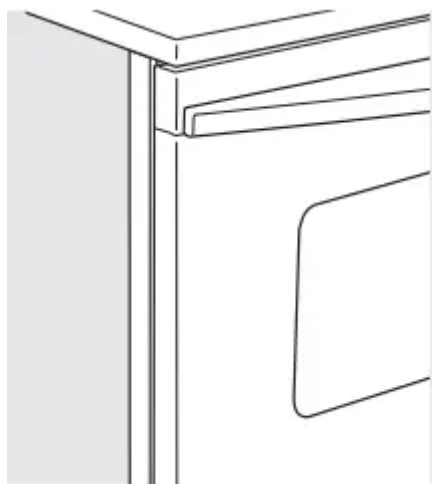

NOTE: On models with an Oven Temp knob, turn it to Broil.

1. Place the meat or fish on a broiler grid in a broiler pan.
2. Follow suggested rack positions in the Broiling Guide.
3. The oven door must be closed during broiling.
4. Touch the Broil Hi/Lo pad once for Hi Broil.
To change to Lo Broil, touch the Broil Hi/Lo pad again.
5. Touch the Start pad.
6. When broiling is finished, touch the Clear/Off pad.

Serve the food immediately, and leave the pan outside the oven to cool during the meal for easiest cleaning.

Use Lo Broil to cook foods such as poultry or thick cuts of meat thoroughly without over-browning them.

The size, weight, thickness, starting temperature and your preference of doneness will affect broiling times. This guide is based on meats at refrigerator temperature

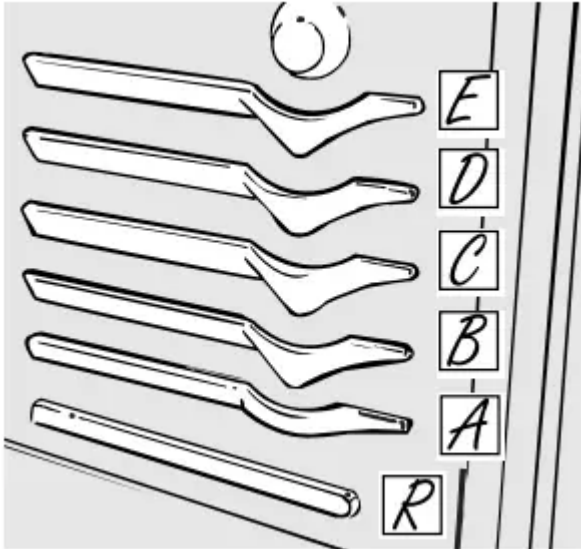

The oven has 5 shelf positions.

Using the clock and timer

To Set the Clock

Make sure the clock is set to the correct time of day.



The clock must be set to the correct time of day for the automatic oven timing functions to work properly. The time of day cannot be changed during a delayed cooking or a delayed self-cleaning cycle.

1. Touch the Clock pad twice.
2. Touch the number pads

Touch the number pads the same way you read them. For example, to set 12:34, touch the number pads 1, 2, 3 and 4 in that order.

If number pads are not touched within one minute after you touch the Clock pad, the display reverts to the original setting. If this happens, touch the Clock pad and reenter the time of day.

3. Touch the Start pad until the time of day shows in the display. This enters the time and starts the clock.

To check the time of day when the display is showing other information, simply touch the Clock pad. The time of day shows until another pad is touched.

To Set the Timer

The timer is a minute timer only. The Clear/Off pad does not affect the timer.



The timer does not control oven operations. The maximum setting on the timer is 9 hours and 59 minutes.

1. Touch the Kitchen Timer On/Off pad.
2. Touch the number pads until the amount of time you want shows in the display. The maximum time that can be entered in minutes is 59. Times more than 59 minutes should be changed to hours and minutes. For example, to enter 90 minutes as 1 hour 30 minutes, touch 1,3 and 0 in that order.
If you make a mistake, press the Kitchen Timer On/Off pad and begin again.
3. Touch the Start pad. After pressing the Start pad, Set disappears; this tells you the time is counting down, although the display does not change until one minute has passed.
4. When the timer reaches :00, the control will beep 3 times followed by one beep every 6 seconds until the Kitchen Timer On/Off pad is touched.

The 6 second tone can be canceled by following the steps in the Special features of your oven control section under Tones at the End of a Timed Cycle.

To Reset the Timer

If the display is still showing the time remaining, you may change it by touching the Kitchen Timer On/Off pad, then touch the number pads until the time you want appears in the display.

If the remaining time is not in the display (clock, delay start or cooking time are in the display), recall the remaining time by touching the Kitchen Timer On/Off pad and then touching the number pads to enter the new time you want.

To Cancel the Timer

Touch the Kitchen Timer On/Off pad twice.

Power Outage

If a flashing time is in the display, you have experienced a power failure. Reset the clock.

Touch the Clock pad once to reset. Enter the correct time of day by touching the appropriate number pads. Touch the Start pad.

Using the timed baking and roasting features

(upper oven only)

If your model has a door latch, do not lock the oven door with the latch during timed cooking. The latch is used for self-cleaning only.

NOTE: Foods that spoil easily—such as milk, eggs, fish, stuffings, poultry and pork—should not be allowed to sit for more than 1 hour before or after cooking. Room temperature promotes the growth of harmful bacteria. Be sure that the oven light is off because heat from the bulb will speed harmful bacteria growth.

How to Set an Immediate Start and Automatic Stop



The upper oven will turn on immediately and cook for a selected length of time. At the end of the cooking time, the oven will turn off automatically.

1. Touch the Bake pad.
2. Touch the number pads to set the desired oven temperature.
3. Touch the Cooking Time pad.
NOTE: If your recipe requires preheating, you may need to add additional time to the length of the cooking time.
4. Touch the number pads to set the desired length of cooking time. The minimum cooking time you can set is 1 minute.

The oven temperature that you set and the cooking time that you entered will be in the display.

5. Touch the Start pad.

The oven will turn ON, and the display will show the cooking time countdown and the changing temperature starting at 100°F. (The temperature display will start to change once the oven temperature reaches 100°F.) When the oven reaches the temperature you set, 3 beeps will sound.

The oven will continue to cook for the set amount of time, then turn off automatically, unless the Cook and Hold feature was set. See the Special features of your oven control section.

After the oven turns off, the end-of-cycle tone will sound.

6. Touch the Clear/Off pad to clear the display if necessary. Remove the food from the oven. Remember, even though the oven turns off automatically, food left in the oven will continue cooking after the oven turns off.

How to Set a Delayed Start and Automatic Stop



The upper oven will turn on at the time of day you set, cook for a specific length of time and then turn off automatically.

Make sure the clock shows the correct time of day.

1. Touch the Bake pad.
2. Touch the number pads to set the desired oven temperature.

3. Touch the Cooking Time pad.

NOTE: If your recipe requires preheating, you may need to add additional time to the length of the cooking time.

4. Touch the number pads to set the desired length of cooking time. The minimum cooking time you can set is 1 minute.

The oven temperature that you set and the cooking time that you entered will be in the display.

5. Touch the Delay Start pad.

6. Touch the number pads to set the time of day you want the oven to turn on and start cooking.

7. Touch the Start pad.

NOTE: An attention tone will sound if you are using timed baking and do not touch the Start pad.

NOTE: If you would like to check the times you have set, touch the Delay Start pad to check the start time you have set or touch the Cooking Time pad to check the length of cooking time you have set.

When the oven turns ON at the time of day you set, the display will show the cooking time countdown and the changing temperature starting at 100°F. (The temperature display will start to change once the oven temperature reaches 100°F.) When the oven reaches the temperature you set, beeps will sound.

The oven will continue to cook for the set amount of time, then turn off automatically, unless the Cook and Hold feature was set. See the Special features of your oven control section.

After the oven turns off, the end-of-cycle tone will sound.

8. Touch the Clear/Off pad to clear the display if necessary. Remove the food from the oven. Remember, even though the oven turns off automatically, food left in the oven will continue cooking after the oven turns off.

Using the probe. (on some models)

If your model has a door latch, do not lock the oven door with the latch while cooking with the probe. The latch is used for self-cleaning only. For many foods, especially roasts and poultry, internal food temperature is the best test for doneness. The temperature probe takes the guesswork out of cooking foods to the exact doneness you want.



The temperature probe has a skewer-like probe at one end and a plug at the other end that goes into the outlet in the oven.

Use of probes other than the one provided with this product may result in damage to the probe.

Use the handles of the probe and plug when inserting and removing them from the food and outlet.



- To avoid damaging your probe, do not use tongs to pull on the cable when removing it.
- To avoid breaking the probe, make sure food is completely defrosted before inserting.
- To prevent possible burns, do not unplug the probe from the outlet until the oven has cooled.
- Never leave your probe inside the oven during a self-cleaning cycle.
- Do not store the probe in the oven

After preparing the meat and placing it on a trivet or on a broiler pan grid, follow these directions for proper probe placement.



Insert the probe completely into the meat.

It should not touch the bone, fat or gristle.

For roasts with no bone, insert the probe into the meatiest part of the roast. For bone-in ham or lamb, insert the probe into the center of the lowest large muscle.

Insert the probe into the center of dishes such as meat loaf or casseroles.

Insert the probe into the meatiest part of the inner thigh from below and parallel to the leg of a whole turkey

Multi-Shelf Baking



When convection baking with only 1 shelf, follow the shelf positions recommended in the Using the Oven section.

The number of shelves provided depends on your model.

Because heated air is circulated evenly throughout the oven, foods can be baked with excellent results using multiple shelves.

Multi-shelf baking may increase cook times slightly for some foods but the overall result is time saved. Cookies, muffins, biscuits and other quick breads give very good results with multi-shelf baking.

When baking larger foods on 3 shelves, place one shelf in the 2nd (A) position, one on the 4th (C) position and the third shelf in the 6th (E) position.

When baking cookies, place the shelves in the 4th (C), 5th (D), and 6th (E) positions.

Special features of your oven control

Your new touch pad control has additional features that you may choose to use. The following are the features and how you may activate them.

The special feature modes can only be activated while the display is showing the time of day. They remain in the control's memory until the steps are repeated.

When the display shows your choice, touch the Start pad. The special features will remain in memory after a power failure.

12-Hour Shut-Off

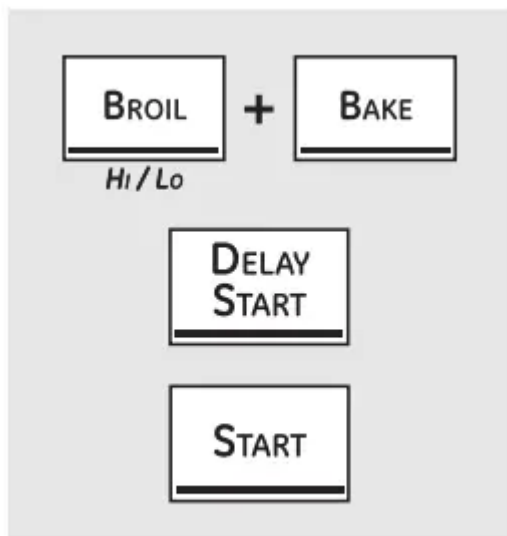

With this feature, should you forget and leave the oven on, the control will automatically turn off the oven after 12 hours during baking functions or after 3 hours during a broil function.

If you wish to turn OFF this feature, follow the steps below.

1. Touch the Bake and Broil Hi/Lo pads at the same time for 3 seconds until the display shows SF.
2. Touch the Delay Start pad. The display will show 12 shdn (12 hour shut-off). Touch the Delay Start pad again and the display will show no shdn (no shut-off).
3. Touch the Start pad to activate the no shut-off and leave the control set in this special features mode.

Fahrenheit or Celsius Temperature Selection

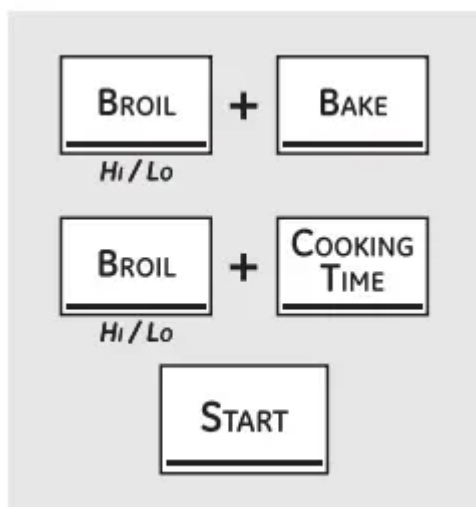

Your oven control is set to use the Fahrenheit temperature selections, but you may change this to use the Celsius selections.

1. Touch the Bake and Broil Hi/Lo pads at the same time for 3 seconds until the display shows SF.
2. Touch the Broil Hi/Lo and Cooking Time pads at the same time. The display will show F (Fahrenheit).
3. Touch the Broil Hi/Lo and Cooking Time pads again at the same time. The display will show C (Celsius).
4. Touch the Start pad.

Tones at the End of a Timed Cycle

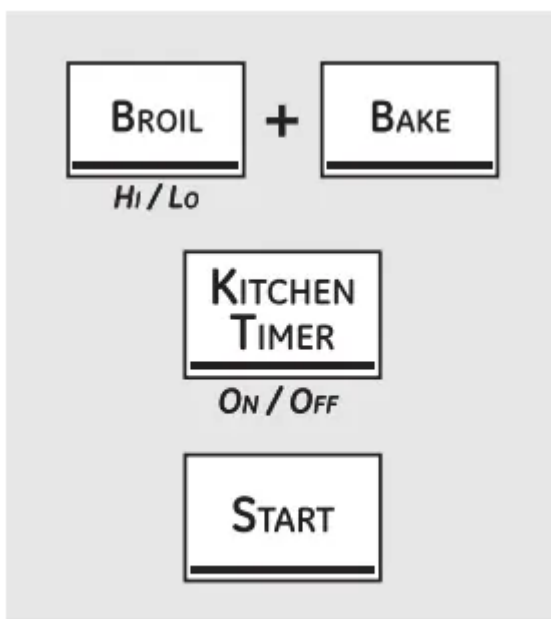

At the end of a timed cycle, 3 short beeps will sound followed by one beep every 6 seconds until the Clear/Off pad is touched. This continual 6-second beep may be canceled.

To cancel the 6-second beep:

1. Touch the Bake and Broil Hi/Lo pads at the same time for 3 seconds until the display shows SF.
2. Touch the Kitchen Timer On/Off pad. The display shows CON BEEP (continual beep) and BEEP. Touch the Kitchen Timer On/Off pad again. The display shows BEEP. (This cancels the one beep every 6 seconds.)
3. Touch the Start pad.

Using the Sabbath Feature

(Designed for use on the Jewish Sabbath and Holidays)

The Sabbath feature can be used for baking/roasting only. It cannot be used for broiling, self-cleaning or Delay Start cooking.

NOTE: The oven light comes on automatically (on some models) when the door is opened and goes off when the door is closed. The bulb may be removed. See the Oven Light Replacement section. On models with a light switch on the control panel, the oven light may be turned on and left on.

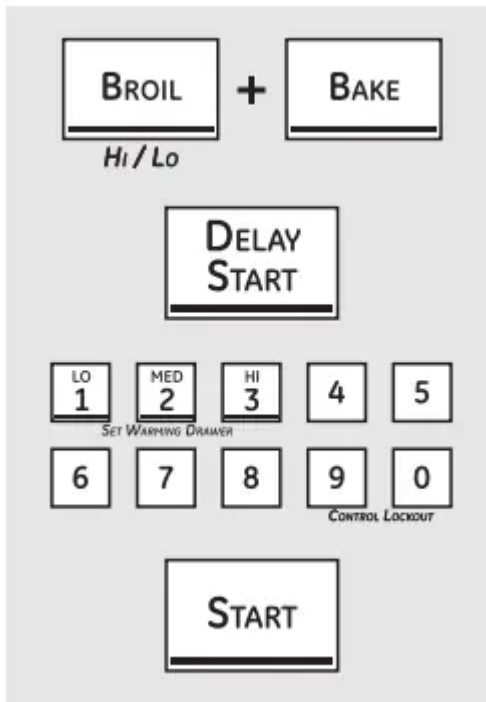

When the display shows the oven is set in Sabbath. When the display shows the oven is baking/roasting.

How to Set for Regular Baking/Roasting

Make sure the clock shows the correct time of day and the oven is off.

1. Touch and hold both the Bake and Broil Hi/Lo pads, at the same time, until the display shows SF.
2. Tap the Delay Start pad until SAb bAtH appears in the display.
3. Touch the Start pad and will appear in the display.
4. Touch the Bake pad. No signal will be given.

5. The preset starting temperature will automatically be set to 350°. Tap the + or – pads to increase or decrease the temperature in 25° increments. The temperature can be set between 170° and 550°. No signal or temperature will be given.

6. Touch the Start pad.

7. After a random delay period of approximately 30 seconds to 1 minute, \supset will appear in the display indicating that the oven is baking/roasting. If $\supset \subset$ doesn't appear in the display, start again at Step 4.

To adjust the oven temperature, touch the Bake pad and tap the + or – pads to increase or decrease the temperature in 25° increments. Touch the Start pad.

NOTE: The Clear/Off and Cooking Time pads are active during the Sabbath feature.

How to Set for Timed Baking/Roasting—Immediate Start and Automatic Stop

When the display shows \supset the oven is set in Sabbath. When the display shows $\supset \subset$ the oven is baking/roasting



NOTE: To understand how the oven control works, practice using regular (non-Sabbath) Immediate Start and Automatic Stop before entering the Sabbath mode.

Make sure the clock shows the correct time of day and the oven is off.

1. Touch and hold both the Bake and Broil Hi/Lo pads, at the same time, until the display shows SF.
2. Tap the Clock pad until SAb appears in the display.

3. Touch the Start pad and \curvearrowright will appear in the display.
4. Touch the Cooking Time pad.
5. Using the number pads, enter the desired temperature between 170° and 550°. No signal or temperature will be given.
6. Touch the Start pad.
7. After a random delay period of approximately 30 seconds to 1 minute, \curvearrowright \curvearrowleft will appear in the display indicating that the oven is baking/roasting. If \curvearrowright \curvearrowleft doesn't appear in the display, start again at Step 4

To adjust the oven temperature, touch the **Bake** pad, enter the new temperature using the number pads and touch the **Start** pad.

NOTE: The **Clear/Off** and **Cooking Time** pads are active during the Sabbath feature.

How to Exit the Sabbath Feature



1. Touch the Clear/Off pad.
2. If the oven is cooking, wait for a random delay period of approximately 30 seconds to 1 minute, until only \curvearrowright is in the display.
3. Touch and hold both the Bake and Broil Hi/Lo pads, at the same time, until the display shows SF.

4. Tap the Delay Start pad until 12 shdn or no shdn appears in the display. 12 shdn indicates that the oven will automatically turn off after 12 hours. no shdn indicates that the oven will not automatically turn off.

5. Touch the Start pad.

NOTE: If a power outage occurred while the oven was in Sabbath, the oven will automatically turn off and stay off even when the power returns. The oven control must be reset.

Adjust the oven thermostat—Do it yourself!

You may find that your new oven cooks differently than the one it replaced. Use your new oven for a few weeks to become more familiar with it. If you still think your new oven is too hot or too cold, you can adjust the thermostat yourself.

Do not use thermometers, such as those found in grocery stores, to check the temperature setting of your oven. These thermometers may vary 20–40 degrees.

NOTE: This adjustment will not affect the broiling or the self-cleaning temperatures. The adjustment will be retained in memory after a power failure.

To Adjust the Thermostat



1. Touch the Bake and Broil Hi/Lo pads at the same time for 2 seconds until the display shows SF.

2. Touch the Bake pad. A two digit number shows in the display.

Touch Bake once to decrease (-) the oven temperature, or twice to increase (+).

3. The oven temperature can be adjusted up as much as 35°F. or down as much as 35°F. Touch the number pads the same way you read them. For example, to change the oven temperature 15°F, touch 1 and 5.

4. When you have made the adjustment, touch the Start pad to go back to the time of day display. Use your oven as you would normally.

NOTE: This adjustment will not affect the broiling or self-cleaning temperatures. It will be retained in memory after a power failure.

The type of margarine will affect baking performance!

Most recipes for baking have been developed using high fat products such as butter or margarine (80% fat). If you decrease the fat, the recipe may not give the same results as with a higher fat product.

Recipe failure can result if cakes, pies, pastries, cookies or candies are made with low fat spreads. The lower the fat content of a spread product, the more noticeable these differences become.

Federal standards require products labeled “margarine” to contain at least 80% fat by weight. Low fat spreads, on the other hand, contain less fat and more water. The high moisture content of these spreads affects the texture and flavor of baked goods. For best results with your old favorite recipes, use margarine, butter or stick spreads containing at least 70% vegetable oil.

Using the electric warming drawer. (on some models)

The warming drawer will keep hot, cooked foods at serving temperature. Always start with hot food. Do not use to heat cold food other than crisping crackers, chips or dry cereal.

To Use the Warming Drawer

1. Touch the Warming Drawer pad. “Warm” and “1” are lit on the display and “Set” begins to blink.
2. On the number pad, press 1 for Low, 2 for Medium or 3 for High.
The display “1” changes corresponding to the number pad selected.
3. Touch the Start pad. “Warm” and the number remain lit. “Set” stops blinking.

To cancel, touch the Warming Drawer pad.

NOTE: Touching the Clear/Off pad does not turn the warming drawer off.

Number Pad	Setting
1	Lo (pies)
2	Med (casseroles)
3	Hi (meats)

NOTES:

- The warming drawer cannot be used during a self-clean cycle.
- The warming drawer has three settings: 1, 2 and 3. These settings maintain different temperature levels in the warming drawer.
- On some models, if using the oven at the same time as the warming drawer, only the oven settings will be displayed.

When Using the Warming Drawer

The warming drawer will keep hot, cooked foods at serving temperature. Always start with hot food. Do not use to heat cold food other than crisping crackers, chips or dry cereal.

Do not line the warming drawer or pan with aluminum foil. Foil is an excellent heat insulator and will trap heat beneath it. This will upset the performance of the drawer and could damage the interior finish.

Allow approximately 25 minutes for the warming drawer to preheat.

- Do not put liquid or water in the warming drawer.
- For moist foods, cover them with a lid or aluminum foil.
- For crisp foods, leave them uncovered.
- Food should be kept hot in its cooking container or transferred to a heat-safe serving dish.

CAUTION: Plastic containers or plastic wrap will melt if in direct contact with the drawer, pan or a hot utensil. Melted plastic may not be removable and is not covered under your warranty.

- Remove serving spoons, etc., before placing containers in warming drawer.

Temperature Selection Chart

To keep several different foods hot, set the control to the food needing the highest setting.

The temperature, type and amount of food, and the time held will affect the quality of the food.

Food in heat-safe glass and glass-ceramic utensils may need a higher control setting as compared to food in metal utensils.

Repeated opening of the drawer allows the hot air to escape and the food to cool.

Allow extra time for the temperature inside the drawer to stabilize after adding items.

With large loads it may be necessary to use a higher warming drawer setting and cover some of the cooked food items.

Do not use plastic containers or plastic wrap.

Food Type	Control Setting
Bacon	3
Breads	2
Casserole	2
Chicken, fried	3
Eggs, scrambled	2
Fish	3
Gravy, sauces	3
Ham	3
Muffins	2
Onion rings	3
Pies	1
Pizza	3
Potatoes, baked	3
Potatoes, mashed	2
Tortilla Chips	1

CAUTION: Do not keep food in the warming drawer for more than two hours.



To Crisp Stale Items

- Place food in low-sided dishes or pans.
- Preheat on 1 setting.
- Check crispness after 45 minutes. Add time as needed.

To Warm Serving Bowls and Plates

To warm serving bowls and plates, set the control on **1**.

- Use only heat-safe dishes.
- If you want to heat fine china, please check with the manufacturer of the dishes for their maximum heat tolerance.
- You may warm empty serving dishes while preheating the drawer.

CAUTION: Dishes will be hot. Use pot holders or mitts when removing hot dishes.

Using the self-cleaning oven

If your model has a door latch, never force the latch handle. Forcing the handle will damage the door lock mechanism. The oven door must be closed and all controls set correctly for the cycle to work properly



Wipe up heavy soil on the oven bottom.

Before a Clean Cycle

Before a Clean Cycle

For the first self-clean cycle, we recommend venting your kitchen with an open window or using a ventilation fan or hood.

Remove any broiler pan, broiler grid, all cookware, probe and any aluminum foil from the oven—they cannot withstand the high cleaning temperatures.

NOTE:

- If your oven is equipped with nickel oven shelves, remove them before you begin the self-clean cycle.
- If your oven is equipped with gray porcelain-coated oven shelves, they may be left in the oven during the self-clean cycle.

Soil on the front frame of the range and outside the gasket on the door will need to be cleaned by hand. Clean these areas with hot water, soap-filled scouring pads or cleansers such as Soft Scrub® Rinse well with clean water and dry.

Do not clean the gasket. The fiberglass material of the oven door gasket cannot withstand abrasion. It is essential for the gasket to remain intact. If you notice it becoming worn or frayed, replace it.

Wipe up any heavy spillovers on the oven bottom.

Make sure the oven light bulb cover is in place and the oven light is off.

IMPORTANT: The health of some birds is extremely sensitive to the fumes given off during the self-cleaning cycle of any range. Move birds to another well ventilated room.

NOTE: Use caution when opening the upper oven after the self-clean cycle has ended.

The oven may still be hot.

How to Set the Upper Oven for Cleaning



1. On models with Gas/Control Lockout, touch and hold the Gas/Control Lockout pad for 3 seconds to turn it off.

NOTE: The surface burners must be turned off prior to the self-clean start time.



2. If your model has a latch, latch the door.
3. Touch the Self Clean pad.
4. Using the number pads, enter the desired clean time, if a time other than hours is needed.

Clean cycle time is normally 4 hours. You can change the clean time to any time between hours and 5 hours, depending on how dirty your oven is.

5. Touch the Start pad.

On models without a door latch, the door locks automatically. The display will show the clean time remaining. It will not be possible to open the oven door until the temperature drops below the lock temperature and the LOCKED DOOR light goes off.

The oven shuts off automatically when the clean cycle is complete.

6. When the LOCKED DOOR light is off, slide the latch handle to the left as far as it will go and open the door. If your range does not have a latch, the door will unlock automatically.
 - The words LOCK DOOR will flash and the oven control will signal if you set the clean cycle and forget to close the oven door or forget to latch the door on models with a latch.
 - To stop a clean cycle, touch the Clear/Off pad. When the LOCKED DOOR light goes off, indicating the oven has cooled below the locking temperature, unlatch the door on models with a latch) and open the door

How to Delay the Start of Cleaning

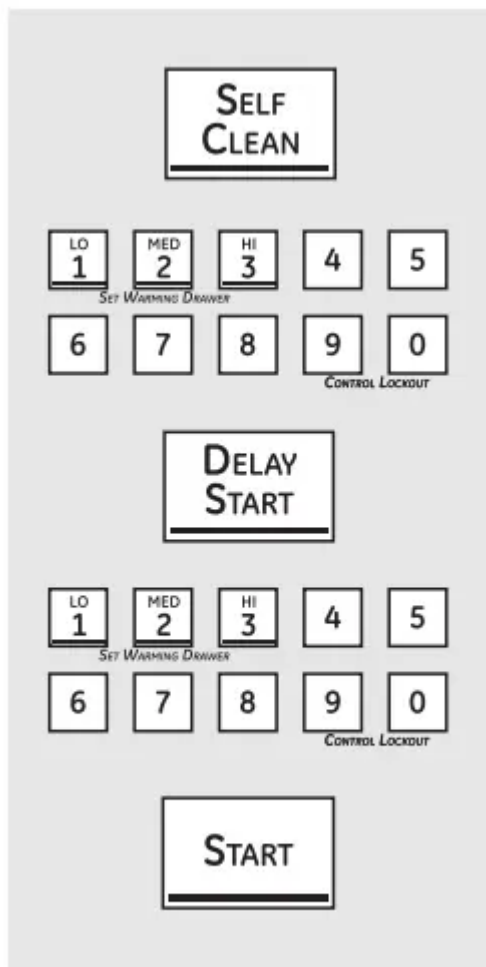

Make sure the clock shows the correct time of day.

1. On models with Gas/Control Lockout, touch and hold the Gas/Control Lockout pad for 3 seconds to turn it off.
NOTE: The surface burners must be turned off prior to the self-clean start time.
2. If your model has a latch, latch the door.
3. Touch the Self Clean pad.
4. Using the number pads, enter the desired clean time.
5. Touch the Delay Start pad. The earliest start time you can set will appear in the display.
6. Using the number pads, enter the time of day you want the clean cycle to start.
7. Touch the Start pad.

On models without a door latch, the door locks automatically. The display will show the start time. It will not be possible to open the oven door until the temperature drops below the lock temperature and the LOCKED DOOR light goes off.

The oven shuts off automatically when the clean cycle is complete.

8. When the LOCKED DOOR light is off, slide the latch handle to the left as far as it will go and open the door. If your range does not have a latch, the door will unlock automatically.
 - The words LOCK DOOR will flash and the oven control will signal if you set the clean cycle and forget to close the oven door or forget to latch the door on models with a latch.
 - To stop a clean cycle, touch the Clear/Off pad. When the LOCKED DOOR light goes off, indicating the oven has cooled below the locking temperature, unlatch the door on models with a latch) and open the door.

After a Clean Cycle

You cannot set the oven for cooking until the oven is cool enough for the door to be unlatched. You may notice some white ash in the oven. Wipe it up with a damp cloth after the oven cools. If white spots remain, remove them with a soap-filled scouring pad and rinse thoroughly with a vinegar and water mixture.

These deposits are usually a salt residue that cannot be removed by the clean cycle.

If the oven is not clean after one clean cycle, repeat the cycle.

- You cannot set the oven for cooking until the oven is cool enough for the door to unlock.
- While the oven is self-cleaning, you can touch the Clock pad to display the time of day. To return to the clean countdown, touch the Cooking Time pad.
- If the racks become hard to slide, apply a small amount of vegetable oil or cooking oil to a paper towel and wipe the edges of the oven racks with the paper towel.

Care and cleaning of the range

Be sure electrical power is off and all surfaces are cool before cleaning any part of the range.



WARNING: If your range is removed for cleaning, servicing or any reason, be sure the anti-tip device is re-engaged properly when the range is replaced. Failure to take this precaution could result in tipping of the range and cause injury.

Burner Assemblies (on some models)



Turn all controls OFF before removing the burner parts.

The round side burner caps can be lifted off, making them easy to clean. The burner bases and electrodes are not removable.

The oval center burner head and cap assembly can be lifted off, making it easy to clean. The burner electrode is not removable.



When one burner is turned to LITE, all the burners spark. Do not attempt to disassemble or clean around any burner while another burner is on. An electric shock may result, which could cause you to knock over hot cookware.

Sealed Burner Assemblies (on some models)



Turn all controls OFF before removing the burner parts.

The round side burner caps and burner heads can be lifted off, making them easy to clean. The electrodes are not removable.

The oval center burner head and cap assembly can be lifted off, making it easy to clean. The burner electrode is not removable.

CAUTION: Do not operate the cooktop without all burner parts and grates in place.





The electrode of the spark igniter is exposed when the burner head is removed. When one burner is turned to LITE, all the burners spark. Do not attempt to disassemble or clean around any burner while another burner is on. An electric shock may result, which could cause you to knock over hot cookware.

Burner Caps and Heads

Before removing the burner caps and heads, remember their size and location. Replace them in the same location after cleaning.



Burner cap is properly seated.



Burner cap is NOT properly seated.

NOTE: Do not use steel wool or scouring powders to clean the burner parts.

Burner caps

Lift off when cool. Wash burner caps in hot, soapy water and rinse with clean water. You may scour with a plastic scouring pad to remove burned-on food particles.

Burner Bases (on some models)

The round burner bases are not removable. Only the caps may be removed for cleaning.

To clean the burner bases, use soapy water and a plastic scouring pad. Wipe clean with a damp cloth.

Make sure that no water gets into the burner bases. Allow them to dry fully before using.

Burner Heads (on some models) and Oval (Center) Burner Head/Cap Assembly

Burner heads (on some models) The burner heads (on some models) are removable. Simply lift them off the range for cleaning.



Make sure the hole in the burner head is positioned over the electrode and that the burner head is fully inserted inside the burner base. A small gap between the base and head is normal.



Make sure the slot in the burner head is positioned over the electrode.



The burner heads and the oval burner head/cap assembly are removable. Simply lift them off the range for cleaning.

For proper ignition, make sure the small hole in the section that fits over the electrode is kept open. A sewing needle or wire twist-tie works well to unclog it.

The slits in the burner heads must be kept clean at all times for an even, unhampered flame.

Clogged or dirty burner ports or electrodes will not allow the burner to operate properly.

Any spill on or around an electrode must be carefully cleaned. Take care to not hit an electrode with anything hard or it could be damaged.

Clean the burner heads routinely, especially after bad spillovers, which could clog the openings. Lift off when cool.

To remove burned-on food, soak the burner heads in a solution of mild liquid detergent and hot water for 20–30 minutes. For more stubborn stains, use a toothbrush.

After cleaning

Before putting the burner caps, heads (on some models) and oval head/cap assembly back, shake out excess water and then dry them thoroughly by setting in a warm oven for 30 minutes.

Replacement

Burner Heads (on some models)

Replace burner heads over the electrodes on the cooktop, in the correct locations according to their size. There is one small, one medium, one large and one extra large burner head



Make sure the slot or hole (depending on model) in the burner head is positioned over the electrode.



Oval (Center) Burner Head/Cap Assembly

Replace the oval (center) head/cap assembly over the electrode on the cooktop



Caps

Replace the matching size caps onto the burner bases or heads.



Make sure that the heads (on some models) and caps are replaced in the correct locations.

Griddle



NOTES:

- The griddle is to be used over the center burner only.
- Do not clean the griddle in a dishwasher.
- Wash with hot, soapy water after each use while using a sponge or dishcloth.
- If oil or food residue is left on the griddle, further cooking will harden the residue and cause sticking over time. In this case, use a non-abrasive cleanser such as Bon Ami® or one of the soft scrub cleansers. Apply with a sponge, Scrunge® or other cleaning pad labeled safe for non-stick pans
- Use only plastic, nylon or wooden utensils or SilverStone® kitchen tools to prevent marring of the coating.
- Never use knives or cut food on the griddle. Wash with hot, soapy water after each use. Store carefully to prevent scratching.

Griddle Precautions:

- If something has spilled under the griddle, it should be cleaned up as soon as possible to prevent “baked on” food soil.
- Do not allow grease to accumulate under the griddle as it can be a fire hazard. Clean under the griddle as soon as it is cool. Clean with hot soapy water.
- Do not place your griddle in the microwave.
- Always turn off all surface burners before removing the griddle. Use caution when handling a hot griddle.

Burner Grates

The grates may be cleaned in a dishwasher.



Your range has three professional-style double grates. These grates are position-specific. For maximum stability, these grates should only be used in their proper position; they cannot be interchanged left to right or front to back. For convenience, the undersides of the left and right grates are marked “LEFT FRONT” and “RIGHT FRONT.” Make sure the front portion of both grates is in front. The middle grate has a bow in front. Make sure the bowed portion is toward the front of the range.



NOTE: Some models only have side grates.

Cleaning

Lift out when cool. Grates should be washed regularly and, of course, after spillovers. Wash them in hot, soapy water and rinse with clean water. When replacing the grates, be sure they are positioned securely over the burners. Replace the grates so that continuous arcs are formed with the center ribs of all three grates.

NOTE: Some models only have side grates.

Do not operate a burner for an extended period of time without cookware on the grate. The finish on the grate may chip without cookware to absorb the heat.

To get rid of burned-on food, place the grates in a covered container. Add 1/4 cup ammonia and let them soak several hours or overnight. Wash, rinse well and dry.

Although they are durable, the grates will gradually lose their shine, regardless of the best care you can give them. This is due to their continual exposure to high temperatures. You will notice this sooner with lighter color grates.

NOTE: Do not clean the grates in a selfcleaning oven.

Cooktop Surface

To avoid damaging the porcelain enamel surface of the cooktop and to prevent it from becoming dull, clean up spills right away. Foods with a lot of acid (tomatoes, sauerkraut, fruit juices, etc.) or foods with high sugar content could cause a dull spot if allowed to set.

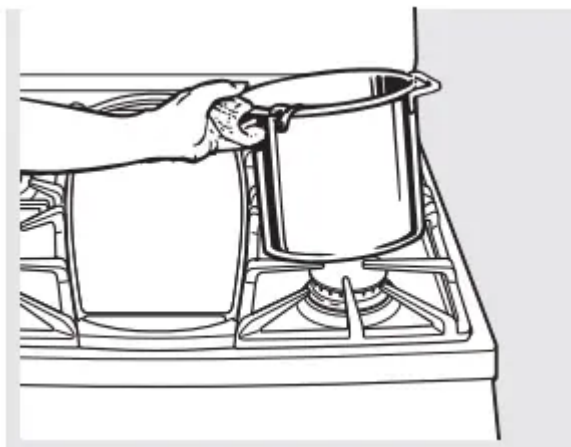

When the surface has cooled, wash and rinse. For other spills such as fat splatterings, etc., wash with soap and water once the surface has cooled. Then rinse and polish with a dry cloth.

NOTE: Do not store flammable materials in an oven, drawer or near the cooktop. Do not store or use combustible materials, gasoline or other flammable vapors and liquids in the vicinity of this or any other appliance.

NOTE: Do not lift the cooktop. Lifting the cooktop can lead to damage and improper operation of the range.

Oven Air Vents



Vent appearance and location vary.

Never block the vents (air openings) of the range. They provide the air inlet and outlet that are necessary for the range to operate properly with correct combustion.

Air openings are located at the rear of the cooktop, at the top and bottom of the oven door, and at the bottom of the range, under the warming drawer or lower oven drawer.

Upper Control Panel



On models so equipped, lock out the touch pads before cleaning.

See the Gas/Control Lockout or Control

Lockout information in the Special features of your oven control section in this manual.

Clean up splatters with a damp cloth.

You may also use a glass cleaner.

Remove heavier soil with warm soapy water.

Do not use abrasives of any kind.

Unlock the touch pads after cleaning

Lower Control Panel (Front Manifold Panel) and Knobs



Surface burner knob



Lower oven drawer knob

It's a good idea to wipe the control panel after each use of the oven. Use a damp cloth to clean or rinse. For cleaning, use mild soap and water or a 50/50 solution of vinegar and water. For rinsing, use clean water. Polish dry with a soft cloth.

Do not use abrasive cleansers, strong liquid cleaners, plastic scouring pads or oven cleaners on the control panel—they will damage the finish.

Do not try to bend knobs by pulling them up or down or by hanging a towel or other such loads. This can damage the gas valve shaft.

The control knobs may be removed for easier cleaning.

Make sure the knobs are in the OFF positions and pull them straight off the stems for cleaning.

The knobs can be cleaned in a dishwasher or they may also be washed with soap and water.

Make sure the insides of the knobs are dry before replacing.

Replace the knobs in the OFF position to ensure proper placement.

Metal parts can be cleaned with soap and water. Do not use steel wool, abrasives, ammonia, acids or commercial oven cleaners. Dry with a soft cloth.

NOTE: The lower oven drawer control knob is not interchangeable with the surface burner knobs. Be sure to reinstall the lower oven drawer knob to the original location. The lower oven drawer knob may be identified by the red line. Surface burner knobs have a white line.

Oven Bottom

The oven bottom has a porcelain enamel finish. To make cleaning easier, protect the oven bottom from excessive spillovers by placing a cookie sheet on the shelf below the shelf you are cooking on. This is particularly important when baking a fruit pie or other foods with a high acid content. Hot fruit fillings or other foods that are highly acidic such as tomatoes, sauerkraut and sauces with vinegar or lemon juice) may cause pitting and damage to the porcelain enamel surface and should be wiped up immediately.

We don't recommend using aluminum foil on the oven bottom. It can affect air flow if the holes are blocked and it can concentrate heat at the bottom of the oven, resulting in poor baking performance.

To clean up spillovers, use soap and water, an abrasive cleaner or soap-filled scouring pad. Rinse well to remove any soap before self-cleaning

Lift-Off Oven Door



Lift the door straight up and off the hinges.



The gasket is designed with a gap at the bottom to allow for proper air circulation.

Do not rub or clean the door gasket—it has an extremely low resistance to abrasion.

If you notice the gasket becoming worn, frayed or damaged in any way or if it has become displaced on the door, you should have it replaced.

The oven door is removable, but it is heavy.

You may need help removing and replacing the door.

To remove the door, open it a few inches to the special stop position that will hold the door open. Grasp firmly on each side and lift the door straight up and off the hinges.

NOTE: Be careful not to place hands between the hinge and the oven door frame as the hinge could snap back and pinch fingers.

To replace the door, make sure the hinges are in the special stop position. Position the slots in the bottom of the door squarely over the hinges. Then lower the door slowly and evenly over both hinges at the same time. If the hinges snap back against the oven frame, pull them back out.

To clean the inside of the door:

- Do not allow excess water to run into any holes or slots in the door.
- Because the area inside the gasket is cleaned during the self clean cycle, you do not need to clean this by hand. Any soap left on the liner causes additional stains when the oven is heated.
- The area outside the gasket can be cleaned with a soap-filled plastic scouring pad.

To clean the outside of the door:

- Use soap and water to thoroughly clean the top, sides and front of the oven door.
- Rinse well. You may also use a glass cleaner to clean the glass on the outside of the door.
- Spillage of marinades, fruit juices, tomato sauces and basting materials containing acids may cause discoloration and should be wiped up immediately. When the surface is cool, clean and rinse.

- Do not use oven cleaners, cleansing powders or harsh abrasives on the outside of the door

Stainless Steel Surfaces (on some models)

Do not use a steel wool pad; it will scratch the surface.

IMPORTANT: APPLY A PROTECTIVE COAT OF CERAMA BRYTE® STAINLESS STEEL BRIGHTENER BEFORE USING. This will help you to maintain the brightness and appearance of your stainless steel range.

- In order to avoid any discolorations and/or grease stains, we recommend cleaning and removing any spills, spots and grease from the range after use.
- It is important to use a soft cloth or paper towel every time the range is cleaned to avoid any scratches.

Read carefully the instructions on the back of the Brightener for better results.

Cleaning Instructions:

1. Remove grates.
2. Wash using warm, soapy water:
 - Wet soft cloth or paper towel (avoid using excessive water).
 - Wipe the surface in the direction of the grain (following the steel lines).
 - Rinse and wring out a soft cloth or paper towel and dry the range.
3. Apply a degreaser that does not contain sodium hydroxide or Stainless Steel Cleaner (follow instructions).
4. Apply Cerama Bryte® Stainless Steel Brightener (follow instructions).
5. Repeat steps 2–4 as many times as needed.
6. Put grates back in place.

Follow these instructions for any Stainless

Steel surface on your range.

DO NOT USE for Cooktop or Stainless Steel parts cleaning:

- Caustic Lye (Sodium Hydroxide) or cleaners containing this chemical
- Hard or Steel Wool Pads
- Abrasive Materials or Chemicals

Oven Shelves and Drawer Racks

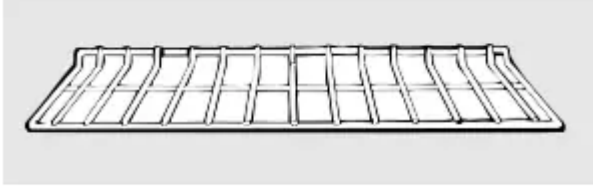

If your oven is equipped with nickel oven shelves, they should be removed from the oven before beginning the self-clean cycle.

To clean the nickel shelves, use an abrasive cleanser. After cleaning, rinse the shelves with clean water and dry with a clean cloth. If the shelves ever become hard to slide, wipe the shelf edges or oven shelf supports with vegetable oil.

If your oven is equipped with gray porcelain-coated shelves, they may be cleaned in the oven during the self-clean cycle.

They may also be cleaned by using an abrasive cleanser. After cleaning, rinse the shelves with clean water and dry with a clean cloth. If the shelves ever become hard to slide, wipe the shelf edges or oven shelf supports with vegetable oil.

Oven Light Replacement

Wire cover holder

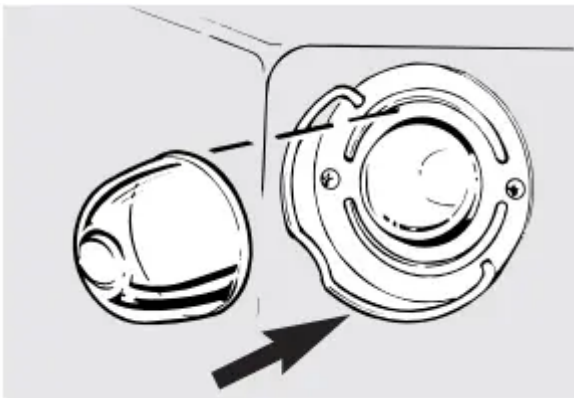

CAUTION: Before replacing your oven light bulb, disconnect the electrical power to the range at the main fuse or circuit breaker panel. Be sure to let the light cover and bulb cool completely.

The oven light bulb is covered with a removable glass cover that is held in place with a bail-shaped wire. Remove the oven door, if desired, to reach cover easily.

To remove:

1. Hold a hand under the cover so it doesn't fall when released. With fingers of the same hand, firmly push back the wire cover holder. Lift off the cover.

Do not remove any screws to remove the cover.

2. Do not touch hot bulb with a wet cloth. Replace bulb with a 40-watt household appliance bulb.

To replace cover:

1. Place it into the groove of the light receptacle. Pull the wire forward to the center of the cover until it snaps into place. When in place, the wire holds the cover firmly. Be certain the wire is in the depression in the center of the cover.

2. Connect electrical power to the range

Removable Storage Drawer (on some models)

The storage drawer may be removed for cleaning under the range.



The storage drawer is a good place to store cookware and bakeware. Do not store plastics and flammable material in the drawer.

The storage drawer may be removed for cleaning under the range. Clean the storage drawer with a damp cloth or sponge. Never use harsh abrasives or scouring pads.

To remove storage drawer:

1. Pull drawer straight out until it stops.
2. Tilt the front of the drawer up and free of the range.

To replace storage drawer:

1. Set the stops on the back of the drawer over the stops in the range.
2. Slide drawer evenly and straight back, so that the rails in the range are engaged.



Removable Lower Oven Drawer Pan



NOTE: For models with an electric warming drawer or lower oven drawer, before performing any adjustments, cleaning or service, disconnect the range electrical power supply at the household distribution panel by removing the fuse or switching off the circuit breaker. Make sure the drawer heating element is cool.

NOTE: Allow lower oven drawer to cool before removing pan.

NOTE: Wipe spills promptly after each use.

- Never place, use or self-clean the lower oven drawer pan in the upper oven.
- Lower oven drawer has a removable pan for easy cleaning. Clean with hot soapy water and a sponge or dish towel. Dry with a clean cloth. An oven cleaner, such as Easy-Off®, may also be used. Be sure to follow the directions on the oven cleaner. Replace the pan in the lower oven drawer.

Troubleshooting

Before you call for service...

Problem	Possible Causes
Top burners do not light or do not burn evenly	Plug on range is not completely inserted in the electrical outlet.
	Burner hole or slits on the side of the burner may be clogged.
	Improper burner assembly.
Burner flames very large or yellow	Improper air to gas ratio.
Surface burners light but oven does not	The oven gas shut-off valve may have accidentally been moved during cleaning moving.
Control signals after entering cooking time or start time (on some models)	You forgot to enter a bake temperature or cleaning time.
Food does not bake or roast properly in the upper oven	Oven controls improperly set.
	Shelf position is incorrect.



	<p>Incorrect cookware or cookware of improper size being used.</p> <p>Oven thermostat needs adjustment.</p> <p>Clock not set correctly.</p> <p>Aluminum foil used improperly in the oven.</p> <p>Oven bottom not securely seated in position.</p>
Burners do not light	<p>Gas/Control Lockout feature is activated.</p> <p>Plug on range is not completely inserted in the electrical outlet.</p> <p>Gas supply not connected or turned on.</p> <p>A fuse in your home may be blown or the circuit breaker tripped.</p> <p>Burner parts not replaced correctly.</p>
Gas/Control Lockout or Control Lockout feature is activated	
Food does not broil properly in the upper oven	<p>Oven controls improperly set.</p> <p>Oven door not closed.</p> <p>Improper shelf position being used.</p> <p>Food being cooked in a hot pan.</p> <p>Cookware not suited for broiling.</p> <p>Oven bottom not securely seated in position.</p>
Upper oven temperature too hot or too cold	<p>Oven thermostat needs adjustment.</p>



Clock and timer do not work	Plug on range is not completely inserted in the electrical outlet.
	A fuse in your home may be blown or the circuit breaker tripped.
	Oven controls improperly set.
Upper oven light does not work	Light bulb is loose or defective.
	Plug on range is not completely inserted in the electrical outlet.
Upper oven will not self-clean	The oven temperature is too high to set a self-clean operation.
	Oven controls improperly set.
	On models with a door latch, the oven door is not in the locked position.
"Crackling" or "popping" sound	This is the sound of the metal heating and cooling during both the cooking and cleaning functions.
Excessive smoking	Excessive soil.
Oven door will not open after a clean cycle	Oven too hot.
Oven not clean after a clean cycle	Oven controls not properly set.
	Oven was heavily soiled.
"Door" appears in the display (on models with a door latch)	Latch handle was moved to the right but a program other than self-clean was selected.



"LOCK DOOR" flashes in the display	The self-clean cycle has been selected but the door is not closed and on models with a door latch, the latch was not moved all the way to the right.
LOCKED DOOR light is on when you want to cook	The oven door is locked because the temperature inside the oven has not dropped below the locking temperature.
"F—and a number or letter" flash in the display	On models with a door latch, if a function error code appears during the self-clean cycle, check the oven door latch.
	You have a function error code.
	If the function code repeats.
Oven shelves are difficult to slide	The nickel shelves (if so equipped) were cleaned in a self-clean cycle. The gray porcelain-coated shelves (if so equipped) were improperly cleaned.
"Probe" appears in the display (some models)	This is reminding you to enter a probe temperature after plugging in the probe.
LOC shows in the display	The Gas/Control Lockout feature is activated.
Display goes blank	A fuse in your home may be blown or the circuit breaker tripped.
	The clock is in the black-out mode.
Display flashes	Power failure.
Unable to get the display to show "SF"	Oven control pads were not pressed properly.

Power outage, clock flashes	Power outage or surge.
"Burning" or "oily" odor emitting from the vent	This is normal in a new oven and will disappear in time.
Strong odor	An odor from the insulation around the inside of the oven is normal for the first few times the oven is used.
Fan noise (some models)	The convection fan may turn on and off automatically.
Convection fan not working (some models)	Preheat temperature not reached.
Drawer does not slide smoothly or drags	The drawer is out of alignment.
	Drawer is over-loaded or load is unbalanced.
Lower oven drawer or warming drawer will not work	A fuse in your home may be blown or the circuit breaker tripped.
	The oven is self-cleaning.
	Controls improperly set.
Excessive condensation in the drawer	Liquid in drawer.
	Uncovered foods.
	Temperature setting too high.
Food dries out in the lower oven drawer or warming drawer	Moisture escaping.
	Drawer not fully closed.

Warning



This content is compiled from multiple sources and is provided for reference purposes only. It may not be complete or fully applicable to all situations. If you are unable to resolve your issue, please contact the product manufacturer or an authorized service provider for official support.

Document generated by [ManualsFile](#)

