

# Specifications

- Standard:
  - DECT 6.0 (Digital Enhanced
  - Cordless Telecommunications 6.0)
  - Bluetooth wireless technology 2.1
- Frequency range:
  - 1.92 GHz to 1.93 GHz (DECT)
  - 2.402 GHz to 2.48 GHz (Bluetooth)
- RF transmission power: 115 mW (max.)
- Power source: 120 V AC, 60 Hz R
- Power consumption:
  - Base unit:
    - Standby: Approx. 0.8 W
    - Maximum: Approx. 3.0 W
  - Charger:
    - Standby: Approx. 0.1 W
    - Maximum: Approx. 1.8 W
- Operating conditions:
  - 0 °C – 40 °C (32 °F – 104 °F), 20 % – 80 % relative air humidity (dry

# Getting Started

## Setting up

### Connections

- If you do not connect the telephone line cord and use only cellular lines, set the cellular line only mode to use this unit more conveniently
- **Base unit**
  1. Connect the AC adaptor to the unit by pressing the plug firmly.
  2. Connect the telephone line cord to the unit until you hear a click.
  3. Fasten the AC adaptor cord and the telephone line cord by hooking it.

4. Connect the AC adaptor to the power outlet.
5. Connect the telephone line cord to the single-line telephone jack (RJ11C) until you hear a click.
6. A DSL/ADSL filter (not supplied) is required if you have a DSL/ADSL service.
7. Connect the corded handset cord to the corded handset and the base unit until you hear a click.

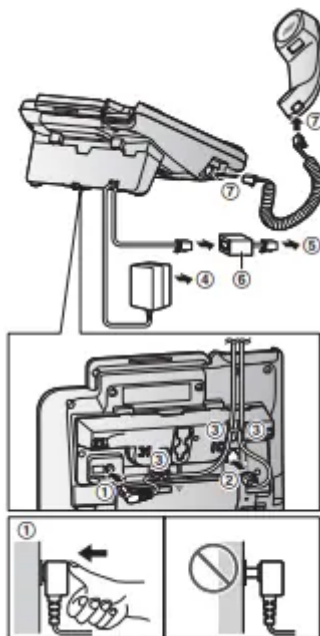

Note:

- Use only the supplied Panasonic AC adaptor PNLV226.
- Follow the directions on the display to set up the unit.
- **Charger**

1. Connect the AC adaptor to the power outlet.



### Handset battery installation

- USE ONLY rechargeable Ni-MH batteries AAA (R03) size (A).
- Do NOT use alkaline/manganese/Ni-Cd batteries.
- Confirm correct polarities ( ⊕ ⊖ ).

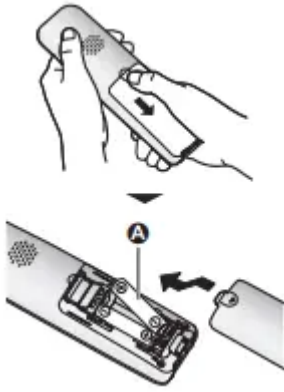

- Follow the directions on the display to set up the unit.

### Handset battery charging

Charge for about 7 hours.

- Confirm “Charging” is displayed ( A ).
- When the batteries are fully charged, “Fully charged” is displayed.



### Handset battery level

Icon	Battery level
	High
	Medium
	Low
	Needs charging.
	Empty

### Panasonic Ni-MH battery performance (supplied batteries)

Operation	Operating time
In continuous use	13 hours max.*1
Not in use (standby)	12 days max.*1

Note:

- Actual battery performance depends on usage and ambient environment.

## Controls

### Handset

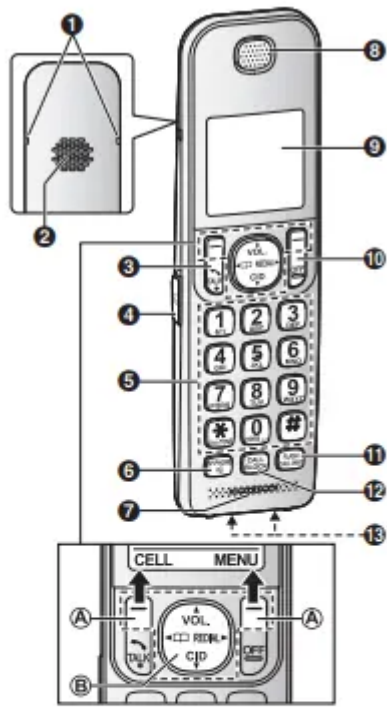

- ❶ Belt clip holes
- ❷ Speaker
- ❸ [TALK]
- ❹ Headset jack
- ❺ Dial keypad (TONE)
- ❻ [SP-PHONE: Speakerphone]
- ❼ Microphone
- ❽ Receiver
- ❾ Display
- ❿ [OFF]
- ⓫ [FLASH] [CALL WAIT]
- ⓬ [CALL BLOCK]
- ⓭ Charge contacts

## • Control type

### A Soft keys

By pressing a soft key, you can select the feature shown directly above it on the display. After a cellular phone is paired, [CELL] is displayed.

### B Navigator key

- [▲], [▼], [◀], or [▶] : Scroll through various lists and items.
- VOL (Volume: [▲] or [▼] : Adjust the receiver or speaker volume while talking.
- [◀] ☐ View the phonebook entry.
- [▶] REDIAL: View the redial list.
- [▼] CID (Caller ID): View the caller list

## Base unit



- 1** Corded handset
  - 2** Receiver
  - 3** Speaker
  - 4** Display
    - The display can be moved back and forth to select the desired angle.
  - 5** ONE-TOUCH DIAL buttons
  - 6** Microphone
  - 7** [SPEED DIAL]
  - 8** [FLASH] [CALL WAIT]
  - 9** [HOLD]
  - 10** [LOCATOR] [INTERCOM]
    - You can locate a misplaced handset by pressing [LOCATOR].
  - 11** Dial keypad (☎): TONE
  - 12** [EXIT]
  - 13** [ERASE]
  - 14** [REDIAL] [PAUSE]
  - 15** [SP-PHONE: Speakerphone] SP-PHONE indicator
  - 16** [CELL 1]
- 
- 17** CELL 1 indicator
  - [CELL 2]
  - CELL 2 indicator
  - 18** [ANS] (ANSWER ON/OFF) ANSWER ON/OFF indicator
  - 19** [CALL BLOCK]
  - 20** [PLAY/STOP] Message indicator
  - 21** Desk stand/Wall mounting adaptor
    - The adaptor is a removable attachment for desk stand or wall mounting use (page 65).

• **Control type**

**A Soft keys**

By pressing a soft key, you can select the feature shown directly above it on the display.





**B Navigator key**















- [▲], [▼], [◀], or [▶]: or : Scroll through various lists and items.

- VOL. (Volume: [▲] or [▼]): Adjust the receiver or speaker volume while talking.
- [⏮]/[⏭]: Repeat/skip messages during playback.

## Display icons/Indicators

### Handset display items

Item	Meaning
	Within base unit range
	Out of base unit range
	The landline is in use. <ul style="list-style-type: none"> <li>• When flashing: The call is put on hold.</li> <li>• When flashing rapidly: An incoming call is now being received.</li> </ul>
	A cellular line is in use.*1 <ul style="list-style-type: none"> <li>• When flashing: The cellular call is put on hold.</li> <li>• When flashing rapidly: A cellular call is being received.</li> </ul>
	Eco mode is on.*2 (page 11)

















Item	Meaning
	A cellular phone is connected.* <sup>1</sup> Ready to make/receive cellular calls. ● When turned off: A cellular phone is not connected to the base unit. (page 18)
 	– A cellular call is in progress on that line. – The cellular line is selected for the setting.
	Noise reduction is set. (page 22)
	Equalizer is set. (page 22)
	Speakerphone is on. (page 20)
	Ringer volume is off.* <sup>3</sup> (page 39, 41)
	Silent mode is on. (page 45)
	Call sharing mode is off. (page 43)
	Alarm is on. (page 44)
	Handset number
	Battery level
	Blocked call (page 28)
	Clarity booster is on.* <sup>2</sup> (page 22)
	Baby monitor is activated. The name/number displayed next to the icon indicates the monitoring unit. (page 46)
<b>In use</b>	Answering system is being used by another handset or the base unit.
<b>Cell1 in use</b>	Someone is using the corresponding line.
<b>Cell2 in use</b>	
<b>C1&amp;C2 in use</b>	
<b>Line in use</b>	

\*1 Corresponding lines (1, 2: cellular line) are indicated next to the item.

\*2 During a cellular call, the item is not displayed even though the feature is activated.

\*3 Corresponding lines (1, 2: cellular line, L: landline) are indicated next to the item. If all lines are turned off, no line is indicated.

## Base unit display items

Item	Meaning
	The landline is in use. <ul style="list-style-type: none"> <li>• When flashing: The call is put on hold.</li> <li>• When flashing rapidly: An incoming call is now being received.</li> </ul>
	A cellular line is in use.*1 <ul style="list-style-type: none"> <li>• When flashing: The cellular call is put on hold.</li> <li>• When flashing rapidly: A cellular call is being received.</li> </ul>
	Ringer volume is off.*2 (page 39, 41)
	Silent mode is on. (page 45)
	Call sharing mode is off. (page 43)
	"Greeting only" is selected. Caller messages are not recorded. (page 63)
	<ul style="list-style-type: none"> <li>– A cellular call is in progress on that line.</li> <li>– The cellular line is selected for the setting.</li> </ul>
	Power backup mode is on. (page 10)
	Blocked call (page 28)
	A Bluetooth headset is connected to the base unit. It is ready for use.
	A Bluetooth headset is in use.
	Answering system is being used by the handset.
	Someone is using the corresponding line.
	
	
	

\*1 Corresponding lines (C1, C2: cellular line) are indicated next to the item.

## CELL indicators on the base unit

The CELL indicators show each cellular line status.

On

- A cellular phone is connected.
- Ready to make/receive cellular calls.

Flashing

- The cellular line is in use.
- Phonebook entries are being copied from a cellular phone.

- The base unit is searching for the paired cellular phone.
- The base unit is pairing a cellular phone.
- A cellular call is put on hold.

Flashing rapidly

- A cellular call is being received.

Light off

- A cellular phone is not paired to the base unit.
- A cellular phone is not connected to the base unit.

## Language settings

### Display language

You can select either “English” or “Español” as the display language. The default setting is “English”.

Handset / Base unit

1 [MENU]#110

2  : Select the desired setting. -> [SAVE]

3 Proceed with the operation for your unit.

Handset: [OFF]

Base unit: [EXIT]

### Date and time

You can configure this setting using either the base unit or one of the handsets.

Handset / Base unit

1 [MENU]#101

2 Enter the current month, date, and year by selecting 2 digits for each. Example: July 12, 2015

07 12 15

3 [OK]

4 Enter the current hour and minute (12-hour clock format) by selecting 2 digits for each.

Example: 9:30

09 30

5 Proceed with the operation for your unit.

Handset:  : Select “AM” or “PM”.

Base unit: MAM/PMN: Select “AM” or “PM”.

6 [SAVE]

7 Proceed with the operation for your unit.

Handset: [OFF]

Base unit: [EXIT]

Note:

- When English is selected as the display language, 12-hour clock format is used. When Spanish is selected, 24-hour clock format is used.

## Recording your greeting message

You can record your own greeting message instead of using a pre-recorded greeting message.

You can configure this setting using either the base unit or one of the handsets.

Handset / Base unit

1 [MENU]#302

2  : “Yes” a MSELECTN

3 Record a greeting message. -> [STOP]

4 Proceed with the operation for your unit.

Handset: [OFF]

Base unit: [EXIT]

## Making/Answering Calls Using the Handset

### Making cellular calls

Important:

- The unit can be used to talk on 2 lines at the same time (for example, 2 cellular lines, or the landline and 1 cellular line).
- Only 2 Bluetooth devices can be used with the unit at the same time (for example, 2 cellular lines, or the headset and 1 cellular line).
- Before making calls, confirm that the corresponding  on the handset is displayed.

1 Lift the handset and dial the phone number.

To correct a digit, press [CLEAR].

2 [CELL]

The unit starts dialing when:



- only 1 cellular phone is paired.
- a specific line is set to make cellular calls

Go to step 4.

3 : Select the desired cellular phone.-> [SELECT]

4 When you finish talking, press [OFF] or place the handset on the charger.

Note:

- To switch to the speaker, press  .
- To switch back to the receiver, press 

### **Adjusting the receiver or speaker volume**

Press  or  repeatedly while talking.

Note:

- The receiver or speaker volume you set is kept for each line (landline and cellular lines).

### **Making a cellular call using the redial list**

The last 5 phone numbers dialed are stored in the redial list (each 48 digits max.).

1  REDIAL

2 : Select the desired phone number.

3 [CELL]

- The unit starts dialing when:
  - only 1 cellular phone is paired.
  - a specific line is set to make cellular calls .

4 : Select the desired cellular phone. -> [SELECT]



## **Programming**

### **Menu list**

To access the features, there are 2 methods.

Handset / Base unit

- **Scrolling through the display menus**





1. [MENU]
2. Press  or  to select the desired main menu. a MSELECTN

3. Press **[▼]** or **[▲]** to select the desired item from the next sub-menus. a MSELECTN
4. Press **[▼]** or **[▲]** to select the desired setting. a MSAVEN

- **Using the direct command code**

1. [MENUN] -> Enter the desired code.Example: Press MMENUN#101.
2. Select the desired setting. -> MSAVEN

Note:

- The unit column shows the unit(s) that can be used to program the item.
  -  Only the handset can program the item.
  -  Only the base unit can program the item.
  -  Both the handset and base unit can program the item.
- To exit the operation, press [OFF] on the handset or [EXIT] on the base unit.
- In the following table, < > indicates the default settings.
- In the following table,  indicates the reference page number.
- Display menu order and sub-menu may vary depending on your model.

### **Display menu tree and direct command code table**

Main menu: ☐ "Phonebook"

Operation	Code	Unit	☑
Viewing the phonebook entry.	#280	📞/📞	32

Main menu: → "Caller list"

Operation	Code	Unit	☑
Viewing the caller list.	#213	📞/📞	49

Main menu:

Handset: ☑ "Answering device"

Base unit: ☑📞 "Answering device"

Sub-menu 1	Sub-menu 2	Settings	Code	Unit	☑
Play new message	-	-	#323	📞	58
Play all message	-	-	#324	📞	58
Erase all message <sup>1</sup>	-	-	#325	📞	59

Sub-menu 1	Sub-menu 2	Settings	Code	Unit	☑
Greeting	Record greeting <sup>1</sup>	-	#302	📞/📞	57
	Check greeting	-	#303	📞/📞	58
	Pre-recorded <sup>1</sup> (Reset to pre-recorded greeting)	-	#304	📞/📞	57
New message alert <sup>1</sup>	Outgoing call - On/Off	On <Off>	#338	📞/📞	60
	Outgoing call - Notification to	-			
	Outgoing call - Remote code	Activate <Inactivate>			
	Base unit beep	On <Off>	#339	📞/📞	59
Settings	Ring count <sup>1</sup>	2-7 rings <4 rings> Toll saver	#211	📞/📞	62
	Recording time <sup>1</sup>	1 min <3 min> Greeting only <sup>2</sup>	#305	📞/📞	63
	Remote code <sup>1</sup>	<111>	#306	📞/📞	61
	Screen call	<On> Off	#310	📞/📞	62
Answer on <sup>1</sup>	-	-	#327	📞	57
Answer off <sup>1</sup>	-	-	#328	📞	57

















Main menu: ☑☑ "Voicemail access"<sup>3</sup>

Operation	Code	Unit	☑
Listening to voicemail messages.	#330	📞/📞	65

Main menu: ⚡ "Intercom"

Operation	Code	Unit	☑
Paging the desired unit.	#274	📞	27

Main menu:  "Bluetooth"

Sub-menu 1	Sub-menu 2	Settings	Code	Unit	
Link to cell - 1: Add new device <sup>*4</sup> (for CELL 1) - 2: Add new device <sup>*4</sup> (for CELL 2)	Connect <sup>*1</sup> / Disconnect <sup>*1</sup>	-	#6251 <sup>*5</sup>		18
			#6252 <sup>*6</sup>		
	Ringer volume	Off-6 <6>	#6281 <sup>*5</sup>		21, 25
			#6282 <sup>*6</sup>		
	Ringer tone <sup>*7</sup>	<Tone 2> <sup>*5</sup> <Tone 4> <sup>*6</sup>	#6291 <sup>*5</sup>		-
			#6292 <sup>*6</sup>		
	Select unit to ring <sup>*1</sup>	Handset 1-6 <All>	#6271 <sup>*5</sup>		17
			#6272 <sup>*6</sup>		
	Ring as cell (limited) <sup>*1</sup>	<On (with Talking CID)> On (without Talking CID) Off	#6141 <sup>*5</sup>		17
			#6142 <sup>*6</sup>		
	Alert settings <sup>*1</sup> - Alert On/Off	<On> Off	#6101 <sup>*5</sup>		54
			#6102 <sup>*6</sup>		
	Alert settings <sup>*1</sup> - Voice alert	<On> Off	#6031 <sup>*5</sup>		54
			#6032 <sup>*6</sup>		
Alert settings <sup>*1,*8</sup> - Alert tone	<Tone 1> <sup>*5</sup> <Tone 2> <sup>*6</sup>	#6041 <sup>*5</sup>		54	
		#6042 <sup>*6</sup>			
Pair	-	#6241 <sup>*5</sup>		16	
		#6242 <sup>*6</sup>			
Unpair	-	#6111 <sup>*5</sup>		16	
		#6112 <sup>*6</sup>			
Phonebook transfer	-	-	#618		52
Headset	Add new device <sup>*4</sup>	-	#621		55
	Connect <sup>*1</sup> / Disconnect <sup>*1</sup>	-	#622		55
	Pair	-	#621		55
	Unpair	-	#612		55



Sub-menu 1	Sub-menu 2	Settings	Code	Unit	
Settings	Auto connect <sup>*1</sup>	<1 min> 3 min 5 min 10 min Off	#632		17
	Cell area code <sup>*1</sup>	–	#633		19
	Cell line only mode <sup>*1</sup>	On <Off>	#157		18
	Cell line select (Handset)	<Manual> Cellphone 1 <sup>*4</sup> Cellphone 2 <sup>*4</sup>	#634		19
	Cell line select (Base unit)	<Cellphone 1> <sup>*4</sup> Cellphone 2 <sup>*4</sup>	#634		
	Set PIN <sup>*1</sup>	<0000>	#619		19
	International code <sup>*1</sup>	–	#117		52
	Country code <sup>*1</sup>	–	#118		
	Trunk prefix <sup>*1</sup>	–	#119		































Main menu: "Set date & time"



























Sub-menu 1	Sub-menu 2	Settings	Code	Unit	
Date and time <sup>*1</sup>	–	–	#101		15
Memo alarm	Alarm1-3	Once Daily Weekly <Off>	#720		44
Time adjustment <sup>*1, *9</sup>	–	<Caller ID auto> Manual	#226		–











Main menu: "Speed dial"

Operation	Code	Unit	
Viewing the speed dial entry.	#261		34

Main menu:  "Settings"

Sub-menu 1	Sub-menu 2	Settings	Code	Unit		
Ring adjustments	Ringer volume <sup>*3</sup>	Off-6 <6>	#160	 	-	
	Ringer tone <sup>*3, *7, *10</sup>	<Tone 1>	#161		-	
	Interrupt tone <sup>*11</sup>	<On> Off	#201	 	23, 26	
	Silent mode - On/Off	On <Off>	#238	 	45	
	Silent mode - Start/End	<11:00 PM/06:00 AM>	#237	 	45	
	Silent mode - Select group	Home Cell 1 Cell 2 Group 4-9	#241	 	45	
Set date & time	Date and time <sup>*1</sup>	-	#101	 	15	
	Memo alarm - Alarm1-3	Once Daily Weekly <Off>	#720		44	
	Time adjustment <sup>*1, *9</sup>	<Caller ID auto> Manual	#226	 	-	
Talking caller ID	-	Handset: <On> Off Base unit: On <Off>	#162	 	49	
Key detector setting <sup>*12</sup> - 1: Add new device (for Detector1) <sup>*13</sup> - 2: Add new device (for Detector2) - 3: Add new device (for Detector3) - 4: Add new device (for Detector4)	Change name <sup>*1</sup>	Detector1	#6561		-	
		Detector2 <sup>*14</sup>	#6562 <sup>*14</sup>			
		Detector3 <sup>*14</sup>	#6563 <sup>*14</sup>			
		Detector4 <sup>*14</sup>	#6564 <sup>*14</sup>			
	Registration	-		#6571		-
				#6572 <sup>*14</sup>		
				#6573 <sup>*14</sup>		
				#6574 <sup>*14</sup>		
	Deregistration	-		#6581		-
				#6582 <sup>*14</sup>		
				#6583 <sup>*14</sup>		
				#6584 <sup>*14</sup>		



Sub-menu 1	Sub-menu 2	Settings	Code	Unit	
Call block <sup>*1</sup>	Block a single number	-	#217	 	28
	Block range of numbers	-		 	29
	Block unknown CID (CID: Caller ID)	Block <Unblock>	#240	 	29
	One ring for blocked call	<Yes> No	#173	 	29
One-touch dial	-	-	#247		35
Speed dial	-	-	#261	 	34
Record greeting <sup>*1</sup>	-	-	#302	 	57
Voicemail <sup>*3</sup>	Save VM access# <sup>*1, *15</sup> (VM: Voicemail) Save Voicemail access# <sup>*1, *16</sup>	-	#331	 	64
	VM tone detect <sup>*1</sup>	<On> Off	#332	 	64
LCD contrast (Display contrast)	-	Handset: Level 1-4 <2> Base unit: Level 1-6 <3>	#145	 	-
Handset name	-	-	#104		47
Display name	-	On <Off>	#105		48
Auto intercom	-	On <Off>	#273	 	27
Key tone	-	<On> Off	#165		-
Caller ID edit (Caller ID number auto edit)	-	<On> Off	#214	 	50
Auto talk <sup>*17</sup>	-	On <Off>	#200		21

Sub-menu 1	Sub-menu 2	Settings	Code	Unit	👍
Set tel line* <sup>1, 3</sup>	Set dial mode	Pulse <Tone>	#120		15
	Set flash time* <sup>18</sup>	900 ms <700 ms> 600 ms 400 ms 300 ms 250 ms 200 ms 160 ms 110 ms 100 ms 90 ms 80 ms	#121		21, 25
	Set line mode* <sup>19</sup>	A <B>	#122		-
Call sharing* <sup>1</sup>	-	<On> Off	#194		22, 26
Registration	Register handset	-	#130		48
	Deregistration* <sup>2</sup>	-	#131		48
Deregistration* <sup>2</sup>	-	-	#131		48
Battery saving mode	-	On <Off>	#150		10
Change language	Display	<English> Español	#110		14
	Voice prompt* <sup>1</sup>	<English> Español	#112		14

Main menu: ? "Customer support"

Operation	Code	Unit	👍
Displaying customer support Web address.	#680		-

Main menu: 😊 "Baby monitor"

Sub-menu 1	Sub-menu 2	Settings	Code	Unit	👍
On/Off	-	On <Off>	#268		46
Sensitivity level	-	Low <Middle> High	#269		47

Main menu: 🗝️ "Key detector"\*<sup>12</sup>

Sub-menu 1	Sub-menu 2	Settings	Code	Unit	👍
Search	-	-	#655		-
Battery check	-	-			

1. If you program these settings using one of the units, you do not need to program the same item using another unit.
2. This menu is not displayed when scrolling through the display menus. It is only available in direct command code.
3. When the cellular line only mode is turned on, these menus are not displayed .
4. After the Bluetooth device is paired, the device name is displayed.
5. For CELL 1
6. For CELL 2

7. The preset melodies in this product (“Tone 3” - “Melody 10”) are used with permission of © 2009 Copyrights Vision Inc.
8. The preset melodies in this product (“Tone 1” and “Tone 2”) are used with permission of © 2013 Copyrights Vision Inc.
9. This feature allows the unit to automatically adjust the date and time each time caller information including date and time is received. To turn this feature on, select “Caller ID auto”. To turn this feature off, select “Manual”. (Caller ID subscribers only) To use this feature, set the date and time first.
10. If you subscribe to a distinctive ring service (such as IDENTA-RING), select a tone (tone 1 or 2). If you select a melody, you cannot distinguish lines by their ringers.
11. This tone lets you know when you receive an outside call while you are on another line or an intercom call. If you select “On”, the tone sounds 2 times.
12. This setting is available when you have the key detector (KX-TGA20). Read the installation manual for more information on the key detector.
13. For models with supplied key detectors, the display shows “1:Detector1”.
14. If you register 2 or more key detectors.
15. Handset
16. Base unit
17. If you subscribe to a Caller ID service and want to view the caller’s information after lifting up the handset to answer a call, turn off this feature.
18. The flash time depends on your telephone exchange or host PBX. Contact your PBX supplier if necessary. The setting should stay at “700 ms” unless pressing [FLASH] fails to pick up the waiting call.
19. Generally, the line mode setting should not be changed. This setting automatically maintains receiver volume at the proper level depending on the current telephone line condition. Set the line mode to “A” if telephone line condition is not good.

## **Answering system for landline**

### **Answering system for landline**

The answering system can answer and record calls for you when you are unavailable to answer the phone.

You can also set the unit to play a greeting message but not to record caller messages by selecting “Greeting only” as the recording time setting.

Important:

- Make sure the date and time setting is correct

## Memory capacity (including your greeting message)

The total recording capacity is about 18 minutes. A maximum of 64 messages can be recorded.

Note:

- When message memory becomes full:
  - 'Messages full' is shown on the handset and base unit display.
  -  on the base unit flashes rapidly if the answering system is turned on.
  - If you use the pre-recorded greeting message, the unit automatically switches to another pre-recorded greeting message asking callers to call again later.
  - If you recorded your own greeting message, the same message is still announced to callers even though their messages are not recorded.

## Turning the answering system on/off

Base unit

Press  to turn on/off the answering system.

Handset

1 To turn on:[MENU]#327

To turn off:[MENU]#328

2 [OFF]

Note for base unit and handset:

- When the answering system is turned on,  on the base unit lights up.

## Greeting message

When the unit answers a call, a greeting message is played to callers.

You can use either:

- your own greeting message
- a pre-recorded greeting message

## Recording your greeting message

You can configure this setting using either the base unit or one of the handsets.

Handset / Base unit

1 [MENU]#302

2  : "Yes" a MSELECTN

3 After a beep sounds, speak clearly about 20 cm (8 inches) away from the microphone (2 minutes max.).

4 Press MSTOPN to stop recording.

5 Proceed with the operation for your unit.

Handset: [OFF]

Base unit: [EXIT]

### Using a pre-recorded greeting message

The unit provides 2 pre-recorded greeting messages:

- If you reset to pre-recorded greeting or do not record your own greeting message, the unit plays a pre-recorded greeting asking callers to leave a message.
- If the message recording time (page 63) is set to "Greeting only", callers' messages are not recorded and the unit plays a different pre-recorded greeting message asking callers to call again.

### Resetting to a pre-recorded greeting message

If you change into a pre-recorded greeting message once you record your own greeting message, your own recorded greeting message is erased.

You can configure this setting using either the base unit or one of the handsets.

Handset / Base unit

1 [MENU]#304

2 [YES]

3 Proceed with the operation for your unit.

Handset: [OFF]

Base unit: [EXIT]

## Listening to messages

### Using the base unit

When new messages have been recorded:

-  on the base unit flashes.
- "New message" is displayed.

Press  (PLAY).

- During playback,  on the base unit lights.
- If new messages have been recorded, the base unit plays back new messages.
- If there are no new messages, the base unit plays back all messages.

## Operating the answering system during playback

Key	Operation
[▲] or [▼]	Adjust the speaker volume
[⏮]	Repeat message* <sup>1</sup>
[⏭]	Skip message
[PAUSE]	Pause message To resume playback, press [▶■].
[▶■] (STOP)	Stop playback
[ERASE]	Erase currently playing message

\*<sup>1</sup> If pressed within the first 5 seconds of a message, the previous message is played.

## Calling back (Caller ID subscribers only)

### • Using a landline:

Lift the corded handset during playback.

- To edit the number before calling back, press [EDIT] repeatedly until the phone number is shown in the desired format.

### • Using a cellular line:

Press [CELL 1] or [CELL 2], then lift the corded handset during playback.

- To edit the number before calling back, press [EDIT] repeatedly until the phone number is shown in the desired format.

## Erasing all messages

Press [ERASE] 2 times while the unit is not in use

## Useful Information

### Voicemail service for landline

Voicemail is an automatic answering service offered by your phone service provider. After you subscribe to this service, your phone service provider's voicemail system answers calls for you when you are unavailable to answer the phone or when your line is busy. Messages are recorded by your phone service provider, not your telephone. Please contact your phone service provider for details of this service.

Important:

- To use the voicemail service provided by your phone service provider rather than the unit's answering system, turn off the answering system.

### Storing the voicemail (VM) access number

In order to listen to your voicemail messages, you must dial your phone service provider's voicemail access number. Once you have stored your voicemail access number, you can dial it automatically (page 65).

You can configure this setting using either the base unit or one of the handsets.

Handset / Base unit

1 [MENU]#331

2 Enter your access number (24 digits max.)-> [SAVE]

3 Proceed with the operation for your unit.

Handset: [OFF]

Base unit: [EXIT]

Note:

- When storing your voicemail access number and your mailbox password, press [▲] (Pause) on the handset or [PAUSE] on the base unit to add pauses between the access number and the password as necessary. Contact your phone service provider for the required pause time.

#### **To erase the voicemail access number**

Handset / Base unit

1 [MENU]#331

2 Press and hold MCLEAR until all digits are erased. -> [SAVE]

3 Proceed with the operation for your unit.

Handset: [OFF]

Base unit: [EXIT]

#### **Voicemail (VM) tone detection**

Handset / Base unit

Your phone service provider sends special signals(sometimes called "voicemail tones" or "stutter tones") to the unit to let you know you have new voicemail messages. If you hear a series of dial tones followed by a continuous dial tone after you press [↵] on the handset or lift the corded handset, you have new voicemail messages. Soon after you hang up a call or after the phone stops ringing, your unit checks the phone line to see if new voicemail messages have been recorded.

Turn this feature off when:

- You do not subscribe to voicemail service.
- Your phone service provider does not send voicemail tones.

- Your phone is connected to a PBX.

If you are not sure which setting is required, contact your phone service provider.

### Turning VM tone detection on/off

The default setting is “On”.

You can configure this setting using either the base unit or one of the handsets.

Handset / Base unit

1 [MENU]#332

2 : Select the desired setting. -> [SAVE]

3 Proceed with the operation for your unit.

Handset: [OFF]

Base unit: [EXIT]

## Wall mounting

The base unit can be mounted on a wall by changing the wall mounting adaptor’s position.

Note:

- Make sure that the wall and the fixing method are strong enough to support the weight of the unit.

### Base unit

1 To remove the wall mounting adaptor, push down the release levers (1). Remove the adaptor (2).

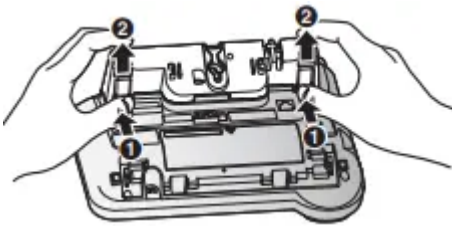

2

- Turn the adaptor so that the words “UP WALL” are facing up.
- Tuck the telephone line cord inside the wall mounting adaptor.
- Connect the AC adaptor cord and telephone line cord.

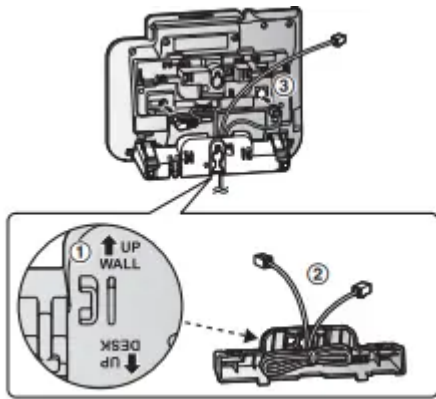

3 Insert the lower tabs of the adaptor into the unit's bottom slots (1), then insert by pushing down the levers of the adaptor into the upper slots (2).

- The words "UP WALL" should be facing up.

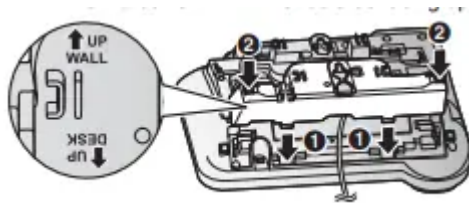

4 Mount the unit on a wall then slide down to secure in place.

- This product is compliant with the following wall phone plate sizes (2 types).

A 83 mm (3 1/4 inches)

B 102 mm (4 inches)

Fit the slots of the unit onto the corresponding wall phone plate tabs for (C) and (D) respectively.

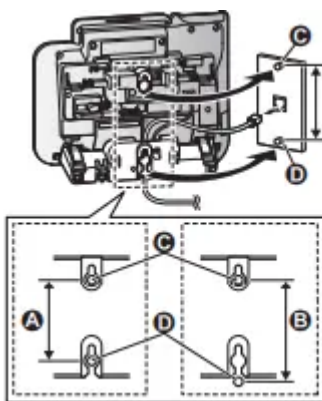

## Charger

Drive the screws (A) (not supplied) into the wall. B 27.2 mm (1 1/16 inches)

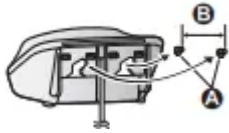

## Error messages

### Ask phone company for VM access #

- You have not stored the voicemail access number. Store the number (page 64).

### Base no power or No link. Reconnect base AC adaptor.

- Confirm the base unit's AC adaptor is connected to the unit and the power outlet correctly.
- The handset has lost communication with the base unit. Move closer to the base unit and try again.
- Unplug the base unit's AC adaptor to reset the unit. Reconnect the adaptor and try again.
- The handset's registration may have been canceled. Re-register the handset.

### Busy

- No cellular phone is paired to the base unit. Pair a cellular phone.
- The called unit is in use.
- Other units are in use and the system is busy. Try again later.
- The handset you are using is too far from the base unit. Move closer and try again.
- Only 2 Bluetooth devices can be used with the unit at the same time (for example, 2 cellular lines, or the headset and 1 cellular line).

### Check tel line

- The supplied telephone line cord has not been connected yet or not connected properly. Check the connections .
- If you do not connect the telephone line cord and use only cellular lines, set the cellular line only mode .

### Error!!

- Recording was too short. Try again.
- Someone is using a cellular line or headset. Try again later.
- The phonebook copy is incomplete. The cellular phone is disconnected from the base unit. Make sure that other Bluetooth devices are not connected to the cellular phone, and try again.

## **Failed**

- Although the unit tried to connect to the cellular phone or headset, the connection has been failed.
  - Someone is using a cellular line or headset. Try again later.
  - Make sure that the cellular phone or headset is not connected to other Bluetooth devices.

## **Invalid**

- There is no handset registered to the base unit matching the handset number you entered.
- The handset is not registered to the base unit. Register the handset.

## **Requires subscription to Caller ID.**

- You must subscribe to a Caller ID service. Once you receive caller information after subscribing to a Caller ID service, this message will not be displayed.

## **Use rechargeable battery.**

- A wrong type of battery such as alkaline or manganese was inserted. Use only the rechargeable Ni-MH batteries noted

## **Troubleshooting**

If you still have difficulties after following the instructions in this section, disconnect the base unit's AC adaptor, then reconnect the base unit's AC adaptor. Remove the batteries from the handset, and then insert them into the handset again.

If the base unit batteries for power backup are installed, remove the batteries from the base unit, and then insert them into the base unit again

## **General use**

### **The handset does not turn on even after installing charged batteries.**

- Place the handset on the charger to turn on the handset.

### **The unit does not work.**

- Make sure the batteries are installed correctly .
- Fully charge the batteries .
- Check the connections .
- Unplug the base unit's AC adaptor to reset the unit. Reconnect the adaptor and try again.
- The handset has not been registered to the base unit. Register the handset.

### **I cannot pair a cellular phone to the base unit.**

- Depending on the compatibility of the cellular phone, you may not be able to pair it to the base unit. Confirm that your cellular phone supports the hands-free profile (HFP) specification.
- Confirm that the Bluetooth feature of your cellular phone is turned on. You may need to turn this feature on depending on your cellular phone.
- The Bluetooth technology on your cellular phone may not be functioning normally. Turn off and on your cellular phone.
- If your cellular phone is already connected to another Bluetooth device such as a Bluetooth headset, turn it off or disconnect it from your cellular phone.
- Some cellular phones may require you to enter the Bluetooth PIN to pairing. Confirm that you entered the correct PIN.

### **I cannot connect a cellular phone to the base unit.**

- Confirm that your cellular phone is turned on.
- Confirm that your cellular phone is within base unit range
- Your cellular phone's Bluetooth feature is turned off. Turn it on.
- Depending on the state of the wireless environment, such as the presence of any electrical interference, there may be a delay even if the auto connection feature is turned on. You can connect to the base unit manually.
- The cellular phone has not been paired to the base unit. Pair the cellular phone
- If your cellular phone is already connected to another Bluetooth device such as a Bluetooth headset or other Panasonic DECT phone, disconnect the device, then perform the connecting procedure to the base unit.
- If your cellular phone is already registered on another Panasonic DECT phone, this function will not work properly. We strongly recommend that you remove the registration of this phone on both your cellular phone and on the other Panasonic DECT phone.

### **I cannot hear a dial tone.**

- Make sure that the CELL indicator lights up (page 14).
- The base unit's AC adaptor or telephone line cord is not connected. Check the connections.
- Disconnect the base unit from the telephone line and connect the line to a known working telephone. If the working telephone operates properly, contact our service personnel to have the unit repaired. If the working telephone does not operate properly, contact your phone service provider.

### **The base unit beeps.**

- New messages have been recorded. Listen to the new messages.

### **The unit does not work during a power failure.**

- You can insert 2 AAA (R03) batteries (not supplied) into the base unit that will power the unit temporarily in the event of a power failure.
- The base unit display is blank if the saving mode is "On".

### **Menu list**

#### **The display is in a language I cannot read.**

- Change the display language.

#### **I cannot register a handset to a base unit.**

- The maximum number of handsets (6) is already registered to the base unit. Cancel unused handset registrations from the base unit

### **Battery recharge**

#### **The handset beeps and/or flashes.**



- Battery charge is low. Fully charge the batteries

#### **I fully charged the batteries, but**

**-  still flashes,**

**-  is displayed, or**

**- the operating time seems to be shorter.**

- Clean the battery ends (, ) and the charge contacts with a dry cloth and charge again.
- It is time to replace the batteries

### **Making/answering calls, intercom**

** is displayed.**

- The handset is too far from the base unit. Move closer.
- The base unit's AC adaptor is not properly connected. Reconnect AC adaptor to the base unit.
- The handset is not registered to the base unit. Register it.

**Noise is heard, sound cuts in and out.**

- You are using the handset or base unit in an area with high electrical interference. Reposition the base unit and use the handset away from sources of interference.
- Move closer to the base unit.
- If you use a DSL/ADSL service, we recommend connecting a DSL/ADSL filter between the base unit and the telephone line jack. Contact your DSL/ADSL provider for details.

**The handset or base unit does not ring.**

- The ringer volume for landline is turned off. Adjust the ringer volume.
- The ringer volume for cellular line is turned off. Adjust the ringer volume.
- The unit which is not selected to ring for cellular calls does not ring. To change the selection.
- Silent mode is turned on. Turn it off.

**I cannot make local calls with the handset or base unit using a cellular line.**

- You need to add your area code when making cellular calls. Store your area code in order to automatically add it to the beginning of the 7-digit phone number when making cellular calls.

**I cannot make or answer cellular calls with the handset or base unit.**

- Depending on the cellular phone's compatibility, you may not be able to make or answer cellular calls even if the cellular phone is connected to the base unit.
- Make sure that the CELL indicator lights up and the cellular phone is connected to the base unit .
- Only 2 Bluetooth devices can be used with the unit at the same time (for example, 2 cellular lines, or the headset and 1 cellular line).
- The cellular phone is being used separately from your system.

**I can make and answer cellular calls but cannot hear a sound.**

- The Bluetooth technology on your cellular phone may not be functioning normally. Turn off and on your cellular phone.
- Disconnect and reconnect the base unit AC adaptor and try again.

**I cannot switch cellular calls from the unit to the cellular phone.**

- Your cellular phone may not support this feature. Refer to the operating instructions of your cellular phone.

**I cannot make a call using a landline.**

- The dialing mode may be set incorrectly. Change the setting

### **I cannot use a cellular line or a landline.**

- The unit can be used to talk on 2 lines at the same time (for example, 2 cellular lines, or the landline and 1 cellular line).

### **I cannot make long distance calls.**

- Make sure that you have long distance service.

### **Caller ID/Talking Caller ID**

#### **Caller information is not displayed.**

- You must subscribe to Caller ID service. Contact your phone service provider for details.
- If your unit is connected to any additional telephone equipment such as a Caller ID box or cordless telephone line jack, plug the unit directly into the wall jack.
- If you use a DSL/ADSL service, we recommend connecting a DSL/ADSL filter between the base unit and the telephone line jack. Contact your DSL/ADSL provider for details.
- The name display service for landline calls may not be available in some areas. Contact your phone service provider for details.
- Other telephone equipment may be interfering with this unit. Disconnect the other equipment and try again.

#### **Caller information is displayed or announced late.**

- Depending on your phone service provider, the unit may display or announce the caller's information at the 2nd ring or later.
- Move closer to the base unit.

#### **Caller information is not announced.**

- The ringer volume for landline is turned off. Adjust the ringer volume .
- The ringer volume for cellular line is turned off. Adjust the ringer volume .
- The unit which is not selected to ring for cellular calls does not announce caller information.
- The Talking Caller ID feature is turned off. Turn it on .
- The ring as cell mode is set to "On (without TalkingCID)"
- The number of rings for the answering system is set to "2 rings" or "Toll saver". Select a different setting.
- Your unit does not announce caller information while the other devices such as headset or handsets are engaged in a call.

#### **The caller list/incoming phone numbers are not edited automatically.**

- The Caller ID number auto edit feature is turned off. Turn it on and try again.

- You need to call back the edited number to activate Caller ID number auto edit.

#### **I cannot dial the phone number edited in the caller list.**

- The phone number you dialed might have been edited incorrectly (for example, the long distance “1” or the area code is missing). Edit the phone number with another pattern

#### **Time on the unit has shifted.**

- Incorrect time information from incoming Caller ID changes the time. Set the time adjustment to “Manual” (off)

#### **The 2nd caller’s information is not displayed during an outside call.**

- In order to use Caller ID, call waiting, or Call Waiting Caller ID(CWID), you must first contact your phone service provider and subscribe to the desired service. After subscribing, you may need to contact your phone service provider again to activate this specific service, even if you already subscribed to both Caller ID and Call Waiting with CallerID services (CWID).

### **Using Bluetooth devices**

#### **I cannot copy phonebook entries from a cellular phone.**

- Confirm that the cellular phone supports Bluetooth wireless technology.
- Confirm that the cellular phone supports the Phone Book Access Profile (PBAP) or Object Push Profile (OPP) specification.
- If the cellular phone is already connected to another Bluetooth device such as a Bluetooth headset, turn it off or disconnect it from the cellular phone.
- Someone is using a cellular line or headset. Try again later.
- Turn the cellular phone off, then turn it on and try again.
- If an entry is already stored in the unit’s phonebook, the entry cannot be copied even by selecting another group. iPhone does not support individual phonebook copy.

#### **I cannot have a conversation using the headset. or I cannot connect my headset to the base unit.**

- Confirm that the Bluetooth wireless headset supports the
- HeadSet Profile (HSP) specification.
- Your Bluetooth headset is not paired. Pair it .
- Turn your headset off, then turn it on and try again.
- If your headset is already connected to another Bluetooth device such as your cellular phone, disconnect the headset from your cellular phone, then perform the connecting procedure from the base unit.

- Only 2 Bluetooth devices can be used with the unit at the same time (for example, 2 cellular lines, or the headset and 1 cellular line).

#### **Noise is heard during a call on the headset.**

- A Bluetooth headset can communicate with the base unit within a range of approximately 10 m (33 feet). The connection may be subject to interference from obstructions such as walls or electronic devices. Move closer to the base unit.

#### **Some headset enhanced features are not available.**

- The base unit does not support enhanced features such as Last number redial or Call reject.

#### **An error tone is heard when I try to program the Bluetooth feature.**

- The Bluetooth feature cannot be accessed immediately after connecting the AC adaptor to the base unit. Wait a few seconds and try again.
- The headset has not connected to the base unit yet, even though you performed the connecting procedure setting. Wait a few seconds and try again.

#### **App alert is not displayed or announced. or Text message alert is not displayed or announced.**

- Confirm that the cellular phone supports the Message Access Profile (MAP) specification to use text message alert feature.
- Confirm that the cellular phone supports the Serial Port Profile (SPP) specification to use App alert feature.
- Confirm that the [Application Alerts manager] setting of your
- Android phone is turned on.
- "Alert On/Off" is set to "Off". Set it to "On" (page 54).
- "Voice alert" is set to "Off". Set it to "On" (page 54).
- The Bluetooth device's Bluetooth notifications setting is turned off.
- The handset selected to display and/or announce alerts is in use.
- The Bluetooth device or its corresponding cellular line is in use.
- Your cellular phone's Bluetooth feature is turned off. Turn it on.

#### **Answering system**

##### **The unit does not record new messages.**

- The answering system is turned off. Turn it on
- The answering system does not answer or record calls from cellular lines.
- The message memory is full. Erase unnecessary messages

- The recording time is set to “Greeting only”. Change the setting
- Your phone service provider’s voicemail service may be answering your calls before the unit’s answering system can answer your calls. Change the unit’s number of rings setting to a lower value, or contact your phone service provider.
- The answering system will not answer incoming calls while the other devices such as headset or handsets are engaged in a call.

**I cannot operate the answering system remotely.**

- The remote access code is not set. Set the remote access code
- You are entering the wrong remote access code. If you have forgotten your remote access code, enter the remote access code setting to check your current code .
- The answering system is turned off. Turn it on .
- You cannot operate the answering system when calling a cellular phone paired to the base unit.

**The unit does not emit the specified number of rings.**

- If the ring once setting is turned off, the number of rings decreases by 1 from the specified number of rings.

**Bluetooth PIN**

**I cannot remember the PIN.**

- Change the PIN using the following method.

Handset/Base unit:

1 [MENU]#619

2 \*7000

3 Enter the new 4-digit PIN.-> [OK]

4 Enter the new 4-digit PIN again. -> [SAVE] -> [OFF]/[EXIT]

**Voicemail**

**Voicemail msg. via phone co.” is shown on the display.**

**How do I remove this message from the display?**

- This notification is displayed when your phone service provider’s voicemail service (not the unit’s answering system) has recorded a message for you. Typically you can remove this notification from the display by listening to the message. To listen to the message, dial the voicemail number provided by your phone service provider (for most cases, this will be your own phone number), and follow the voice instructions. Depending on your



phone service provider, you may need to remove all messages from your voice mailbox to remove the notification. You can also remove this notification by pressing and holding # until the unit beeps.

## Liquid damage

### Liquid or other form of moisture has entered the handset/base unit.

- Disconnect the AC adaptor and telephone line cord from the base unit. Remove the batteries from the handset and leave to dry for at least 3 days. After the handset/base unit are completely dry, reconnect the AC adaptor and telephone line cord. Insert the batteries and charge fully before use. If the unit does not work properly, contact an authorized service center.

#### Warning

This content is compiled from multiple sources and is provided for reference purposes only. It may not be complete or fully applicable to all situations. If you are unable to resolve your issue, please contact the product manufacturer or an authorized service provider for official support.