

## CONTROL PANEL AND FEATURES

### STANDARD VENT MODELS

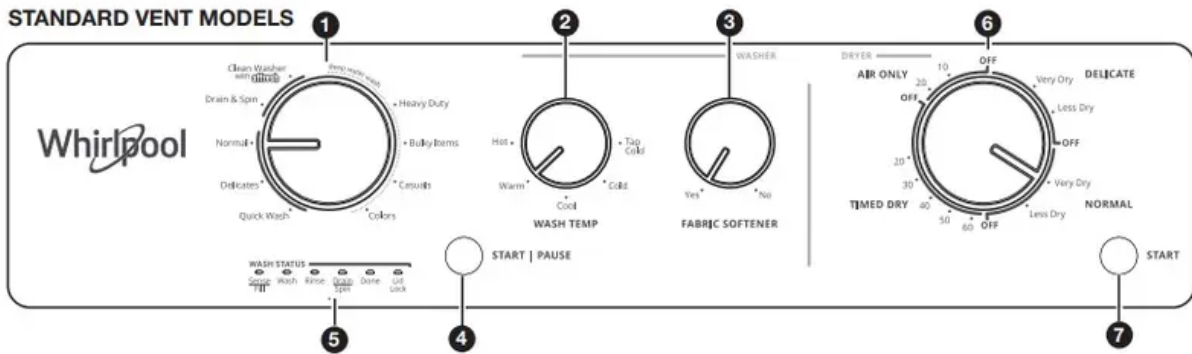

### STANDARD VENT MODELS

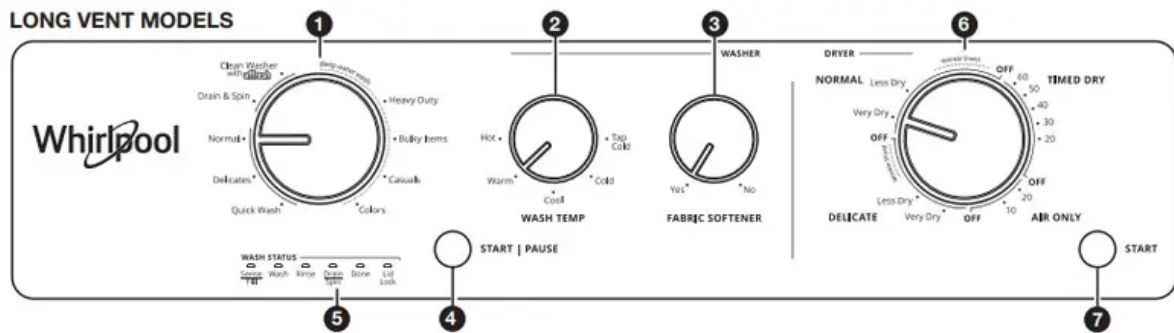

Not all features and options are available on all models. Appearance may vary

### WASHER

#### 1. WASH CYCLE KNOB

Use the Wash Cycle knob to select available cycles on your washer. Turn the knob to select a cycle for your laundry load. See “Washer Cycle Guide” for detailed descriptions of cycles.

#### 2. WASH TEMP

You may select a Wash Temperature based on the type of fabric and soils being washed. Use the warmest wash water safe for the fabric. Follow garment label instructions.

#### 3. FABRIC SOFTENER

Set this knob to Yes when adding fabric softener to the fabric softener dispenser.

#### 4. START/PAUSE

Press the START/PAUSE button to start the washer.



## 5. WASH STATUS INDICATOR LIGHTS



The Cycle Status lights show the progress of a cycle.

At each stage of the process, you may notice sounds or pauses that are different from your previous washer.

### SENSE FILL

When the Start/Pause button is pressed, the washer will fill and begin sensing to determine load size and balance.

Once sensing is complete, the washer will fill to the appropriate level for the detected load size and then begin the wash phase of the cycle.

**NOTE:** Sensing and wash phases will be paused by opening the unlocked lid. Close the lid to resume the cycle. If the lid is left open for more than 10 minutes, the washer will cancel the cycle and pump out the water. The lid will lock after the wash phase to begin the initial spinout and remain locked for the remainder of the cycle.

### WASH

The washer will fill to the correct water level based on the load size. Certain cycles may agitate during the fill process to boost cleaning. You will hear the agitator rotate, followed by a pause lasting several seconds. When the wash cycle begins, you will hear the agitator increase speed. The motor sounds may change at different stages in the wash cycle while the washer performs different wash actions.

### RINSE

Certain cycles use a spray rinse, which adds water to the tub while the basket spins. You may hear the motor turning on briefly (short hum) to move the basket while filling.

### DRAIN/SPIN

The washer spins the load at increasing speeds for proper water removal, based on the selected cycle.

### DONE

Once the cycle is complete, this light will come on. Remove the load promptly for best results.

### LID LOCK

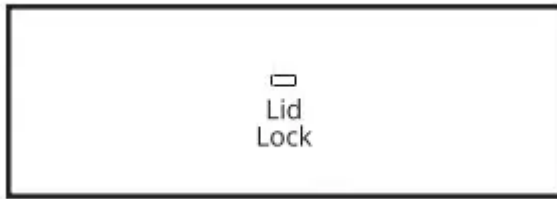

The Lid Lock feature allows for higher spin speeds. When the Lid Lock light is lit, the lid is locked and cannot be opened without pausing the cycle. When the light is off, the lid can be opened. To open the lid after it has been locked, press START/PAUSE. The lid will unlock once the washer movement has stopped. This may take several minutes if the load was spinning at high speed. Press START/PAUSE again to resume the cycle.



## DRYER

### 6- DRYER CYCLE KNOB

Use your Dryer Cycle knob to select available cycles on your dryer. Turn the knob to select a cycle for your laundry load. See “Dryer Cycle Guide” for detailed descriptions of cycles.

#### TIMED DRY

Will run the dryer for the specified time on the control. Drying time and temperature will depend on your dryer model.

#### NORMAL and DELICATE CYCLES

These cycles sense moisture in the load or air temperature and shut off when the load reaches the selected dryness level. They give the best drying in the shortest time. Drying time will vary based on fabric type, load size, and dryness setting. AIR ONLY This cycle will run the dryer without heat for the specified time on the control.

### 7-START BUTTON

The Start button is used to start the dryer. The end-of-cycle signal produces an audible sound when the drying cycle is finished. Promptly removing clothes at the end of the cycle reduces wrinkling.

## WASHER CYCLE GUIDE

Each cycle listing includes a performance chart rating its cleaning power, gentleness on items, and resource efficiency. Not all cycles or options are available on all models. Refer to the cycle control

knob on your washer. Wash temperatures are selected using the Wash Temp knob. Cycles marked with “deep water wash” use a higher level of water.

For best performance:

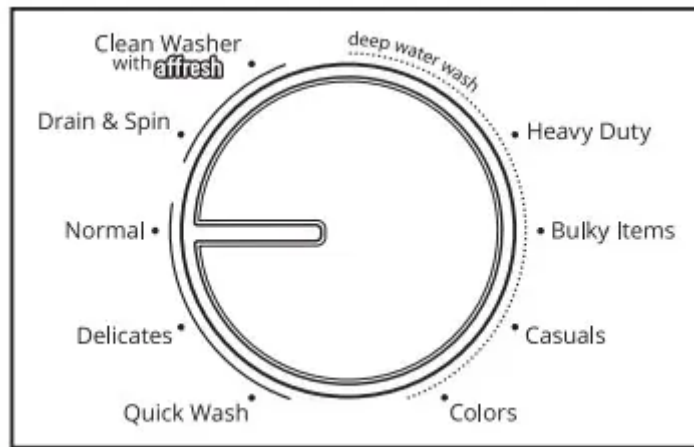













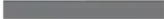

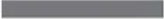
- Choose the cycle that best fits the load being washed.
- Decrease or increase the maximum target water temperature for any cycle.
- Do not leave the washer lid open unattended once the washer has started to fill.

Items to wash:	Cycle:	Load Size:	Wash/Spin Speed:	Cycle Details:
Cottons, linens, and mixed-garment loads	<b>Normal</b>		High and Low/High	Use this cycle for normally soiled cottons and mixed-fabric loads. Good Best Cleaning Gentleness Efficiency†
No-iron fabrics, cottons, permanent press, linens, synthetics	<b>Casuals</b>		High and Low/Low	Use this cycle to wash loads of no-iron fabrics such as sport shirts, blouses, casual business clothes, permanent press, and blends. Good Best Cleaning Gentleness Efficiency†
Machine-wash silks, hand-washed fabrics	<b>Delicates</b>		Low/Low	Use this cycle to wash lightly soiled garments indicating “Machine Washable Silks” or “Gentle” cycle on the care label. Place small items in mesh garment bags before washing. Good Best Cleaning Gentleness Efficiency†

Efficient use of resources, such as energy and water.

**IMPORTANT:** Do not presoak items in your washer by lifting the lid or stopping the cycle. Failure to follow this instruction can result in property damage. If needed, presoak items in a small wash basin prior to loading the washer.



Items to wash:	Cycle:	Load Size:	Wash/Spin Speed:	Cycle Details:
Sturdy fabrics, colorfast items, towels, jeans	<b>Heavy Duty</b>		High/High	Use this cycle for heavily soiled or sturdy items, or when using bleach.  Good Best Cleaning  Gentleness  Efficiency! 
Colored cottons, linens, casual and mixed loads	<b>Colors</b>		High/High	Use this cycle for normally soiled colors and mixed-fabric loads.  Good Best Cleaning  Gentleness  Efficiency! 
Large items such as sheets, sleeping bags, small comforters, jackets, small washable rugs	<b>Bulky Items</b>		Low/Low	Use this cycle to wash large items such as jackets and small comforters. The washer will fill with enough water to wet down the load before the wash portion of the cycle begins, and uses a higher water level than other cycles.  Good Best Cleaning  Gentleness  Efficiency! 
Lightly soiled fabrics	<b>Quick Wash</b>		High/High	Use this cycle to quickly wash a small number of lightly soiled items.  Good Best Cleaning  Gentleness  Efficiency! 
Hand-washed garments or dripping-wet items	<b>Drain &amp; Spin</b>	N/A	N/A/ High	This cycle uses a spin to shorten drying times for heavy fabrics or special-care items washed by hand. Use this cycle to drain washer after cancelling a cycle or completing a cycle after a power failure.
No clothes in washer	<b>Clean Washer with affresh®</b>	N/A	Low/ N/A	Use this cycle every 30 washes to keep the inside of your washer fresh and clean. This cycle uses a higher water level. Use with affresh® washer cleaner tablet or regular liquid chlorine bleach to thoroughly clean the inside of your washer. This cycle should not be interrupted. See "Washer Care." <b>IMPORTANT:</b> Do not place garments or other items in the washer during the Clean Washer with affresh® cycle. Use this cycle with an empty wash tub. Do not use thickened, easy-pour, or no-splash bleach when running the Clean Washer with affresh® cycle as excess suds may occur. See "Washer Care" in "Washer/Dryer Maintenance."

Efficient use of resources, such as energy and water.

**IMPORTANT:** Do not presoak items in your washer by lifting the lid or stopping the cycle. Failure to follow this instruction can result in property damage. If needed, presoak items in a small wash basin prior to loading the washer.

## DRYER CYCLE GUIDE – AUTOMATIC DRY CYCLES

Not all cycles and settings are available on all models. Both the Normal and Delicate cycles are automatic dry cycles. They give the best drying in the shortest time. They sense moisture in the load or air temperature and shut off when the load reaches the selected dryness level. Drying time varies based on fabric type, load size, and dryness setting. Select either the Normal or Delicate cycle based on the fabrics in your load. If you are unsure of the cycle to select for a load, select the Delicate cycle (lower temperature) rather than the Normal cycle (higher temperature).

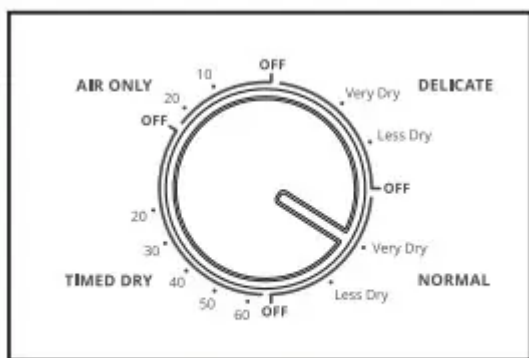

**Standard Vent Models**

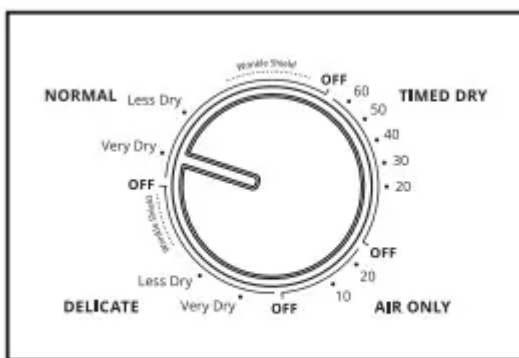

**Long Vent Models**

### WRINKLE SHIELD™ option (long vent models)

This feature will run after your drying cycle is complete. It periodically starts and stops the dryer, tumbling the load without heat to help avoid wrinkling.

Items to dry:	Cycle:	Available Options:	Cycle Details:
Corduroys, work clothes	Normal	None	Medium to large loads of mixed fabrics and items.
Lingerie, blouses, washable knit fabrics	Delicate	None	For gently drying delicate items.

**NOTE:** If loads do not seem as dry as you would like, select Very Dry next time you dry a similar load. If loads seem drier than you like, select Less Dry next time you dry a similar load.

## DRYER CYCLE GUIDE – TIMED DRYING

Not all cycles and settings are available on all models. Will run the dryer for the selected time.

Items to dry:	Cycle:	Temperature:	Available Options:	Cycle Details:
Rubber, plastic, heat-sensitive fabrics	Air Only	No Heat	Time Adjustment	For airing out, refreshing, and loosening up laundry without heating.
Heavy, bulky, or lightweight items	Timed Dry	High	Time Adjustment	Completes drying if items are still damp.

**NOTE:** Government energy certifications for this model were based on the Timed Dry cycle with the Maximum drying temperature setting. The as-shipped defaults of Normal cycle, Less Dry, and the Wrinkle Shield™ option (when applicable) were not used.

## USING YOUR WASHER

### 1. Sort and prepare your laundry

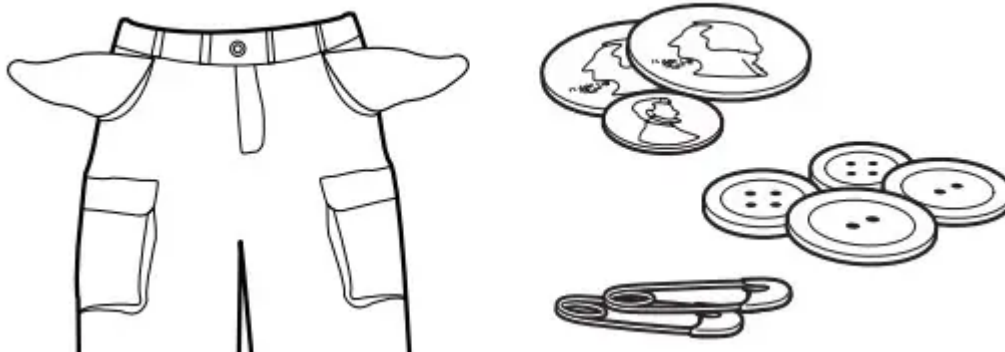

- Empty pockets. Loose change, buttons, or any small object can pass under the agitator and become trapped, causing unexpected sounds.
  - Sort items by recommended cycle, water temperature, and colorfastness.
  - Separate heavily soiled items from lightly soiled.
  - Separate delicate items from sturdy fabrics.
  - Do not dry garments if stains remain after washing, because heat can set stains into fabric.
  - Treat stains promptly. n Close zippers, fasten hooks, tie strings and sashes, and remove non-washable trim and ornaments.
  - Mend rips and tears to avoid further damage to items during washing.
- Helpful Tips:
- When washing waterproof or water-resistant items, load evenly.
  - Use mesh garment bags to help avoid tangling when washing delicate or small items.
  - Turn knits inside out to avoid pilling. Separate lint-takers from lint-givers. Synthetics, knits, and corduroy fabrics will pick up lint from towels, rugs, and chenille fabrics.

**NOTE:** Always read and follow fab

## 2. Add laundry products

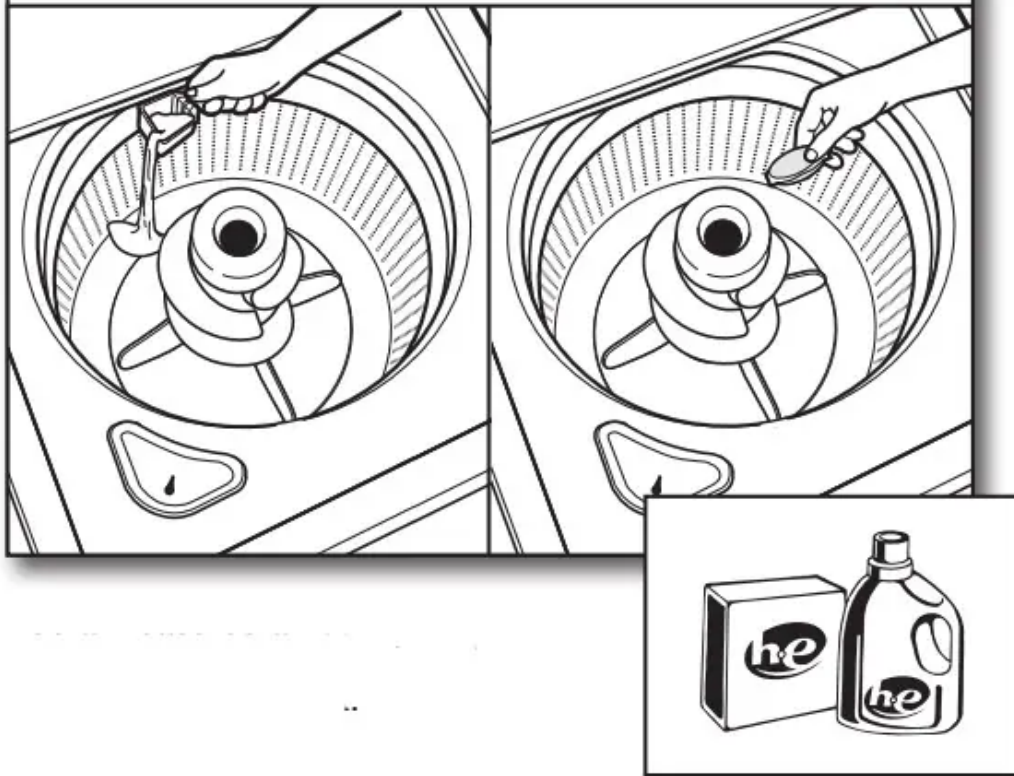

Add a measured amount of HE detergent or single-dose laundry packet into the basket. If using Oxi-type boosters, color-safe bleach, or fabric softener crystals, add to the bottom of the washer basket before adding clothes.

**IMPORTANT:** Use only High Efficiency detergents. The package will be marked “HE” or “High Efficiency.” Using non-HE detergent will likely result in longer cycle times and reduced rinsing performance. It may also result in component malfunction and, over time, buildup of mold or mildew. HE detergents should be low-sudsing and quick-dispersing to produce the right amount of suds for the best performance. They should hold soil in suspension so it is not redeposited onto clean clothes. Not all detergents labeled as High Efficiency are identical in formulation and their ability to reduce suds. For example, natural, organic, or homemade HE detergents may generate a high level of suds.

**NOTE:** Follow the manufacturer’s instructions to determine the amount of laundry products to use.

### 3. Load laundry into washer

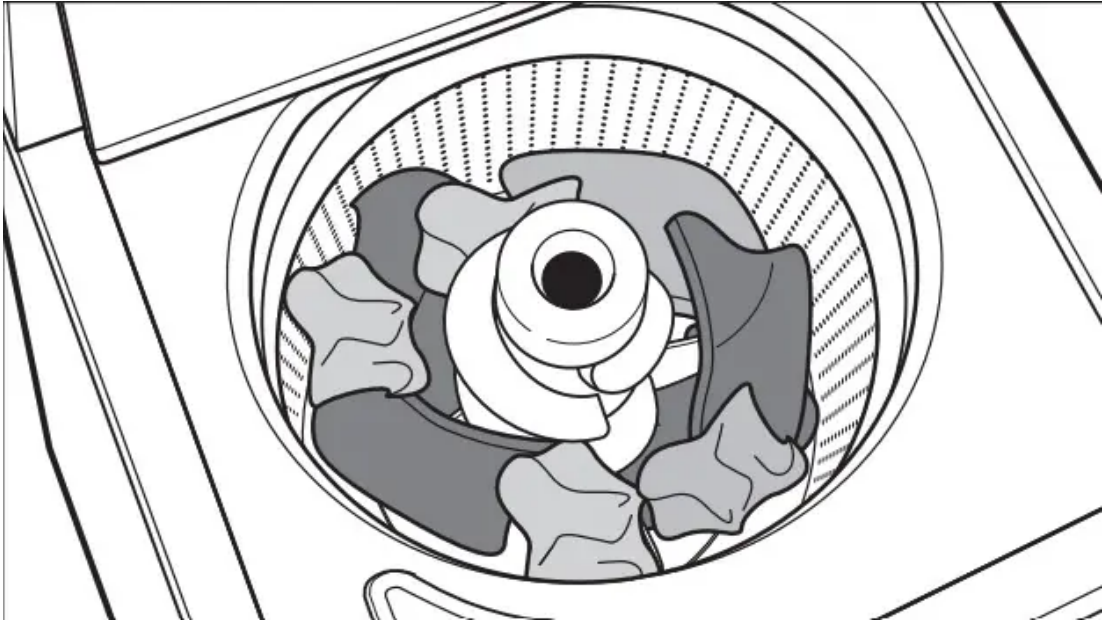

Load garments in loose heaps evenly around basket wall. For best results, do not pack the load tightly. Do not wrap large items such as sheets around the agitator; load them in loose piles around the sides of the basket. Try mixing different-sized items to reduce tangling.



**IMPORTANT:** Do not tightly pack or force items into washer. Items need to move freely for best cleaning and to reduce wrinkling and tangling.

#### 4. Add liquid chlorine bleach to dispenser

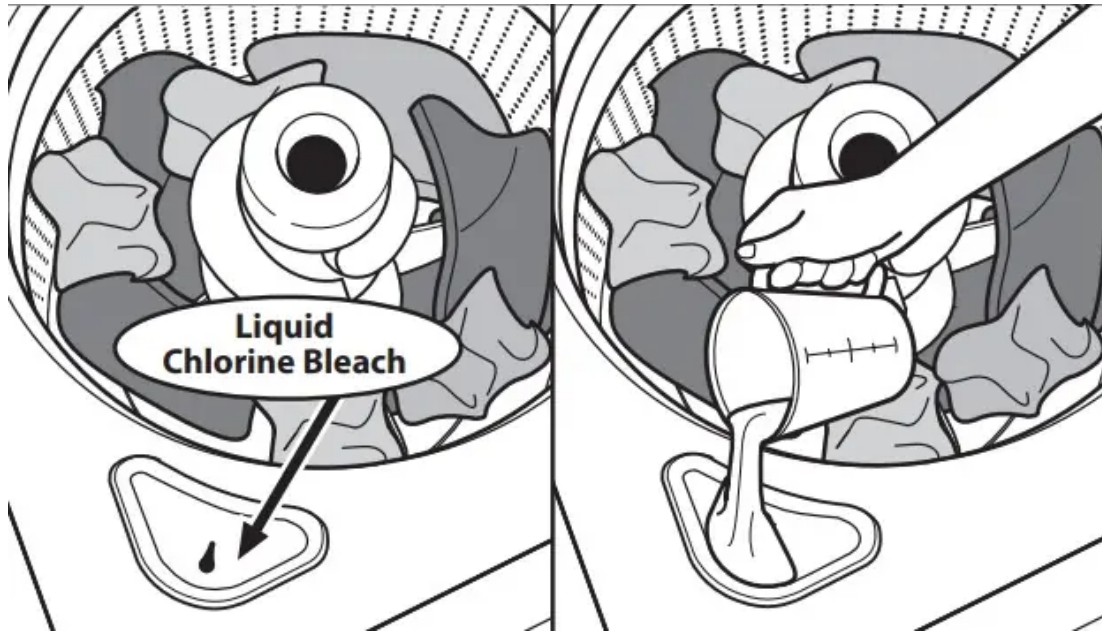

Do not overfill, dilute, or use more than 1 cup (236 mL). Do not use color-safe bleach or Oxi products in the same cycle with liquid chlorine bleach.

#### 5. Add fabric softener to dispenser

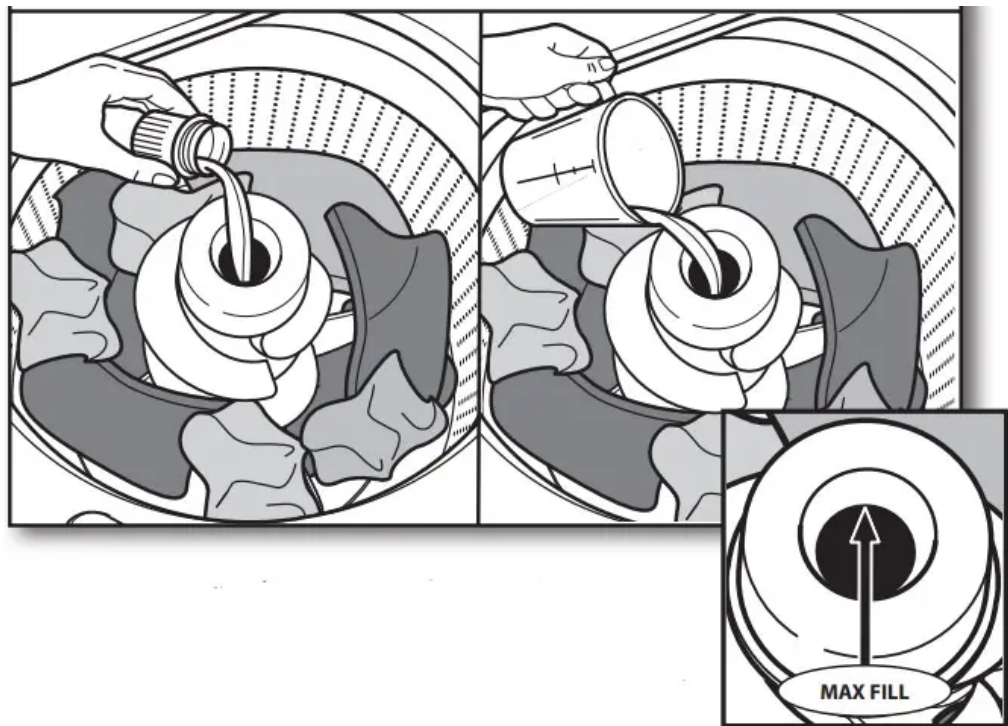

Pour a measured amount of liquid fabric softener into dispenser; always follow manufacturer's directions for correct amount of fabric softener based on your load size. Dilute liquid fabric softener by filling the dispenser with warm water until liquid reaches the underside of the rim. See max fill line arrows. Do not overfill.

#### **Adding Liquid Fabric Softener Manually to Wash Load**

During the final rinse, wait until the washer has completed filling and press the START/

PAUSE button to pause the washer. Lift the lid and add the measured recommended amount of liquid fabric softener. Do not allow liquid fabric softener to spill, splash, drip, or run into the basket or on load. Do not use more than the recommended amount. Close the lid and press the START/ PAUSE button again to start the washer.

## 6. Select cycle

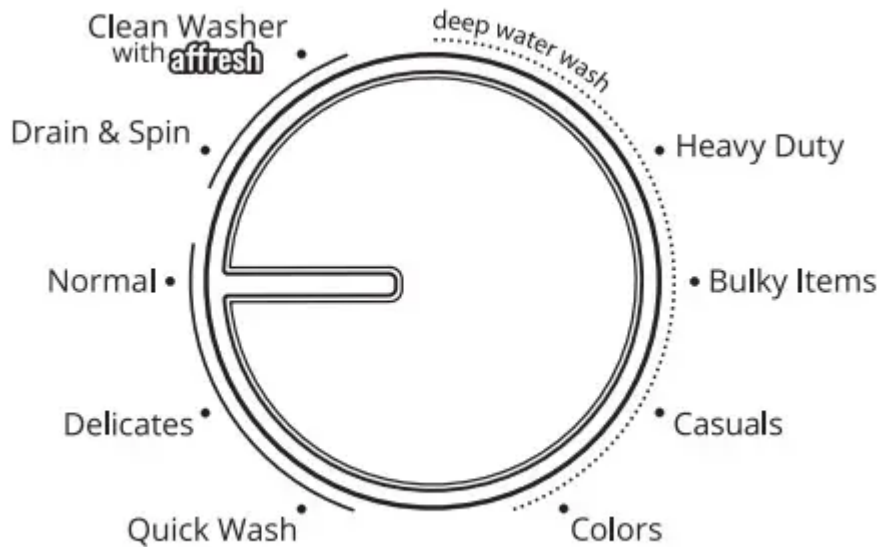

Turn cycle knob to choose your wash cycle. For more information, see “Washer Cycle Guide.”

## 7. Select wash temperature

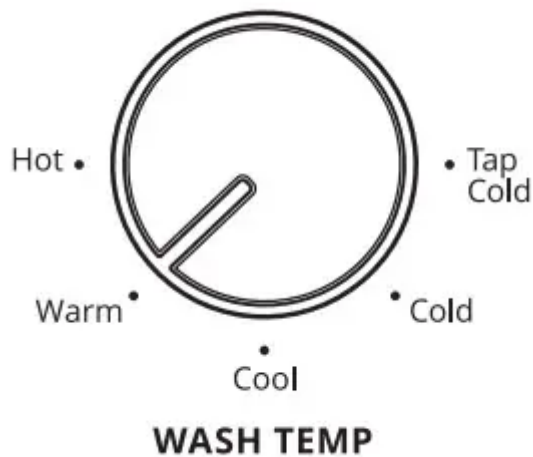

Select the desired wash temperature by turning the Wash Temp knob to the desired setting. All rinses are cold.

**NOTE:** Always read and follow fabric care label instructions to avoid damage to your garments.

Wash Temp	Suggested Fabrics
<p>Hot</p> <p>Some cold water is added to save energy. This will be cooler than your hot water heater setting.</p>	<p>Whites and pastels Durable garments Heavy soils</p>
<p>Warm</p> <p>Some cold water will be added, so this will be cooler than what your previous washer provided.</p>	<p>Bright colors Moderate to light soils</p>
<p>Cool</p> <p>Some warm water may be added to assist in soil removal and to help dissolve detergents. Cool is slightly warmer than cold.</p>	<p>Colors that bleed or fade Light soils</p>
<p>Cold</p> <p>This is the temperature from your faucet. Warm water may be added to assist in soil removal and to help dissolve detergents</p>	<p>Dark colors that bleed or fade Light soils</p>
<p>Tap Cold</p> <p>This is the temperature from your faucet.</p>	<p>Dark colors that bleed or fade Light soils</p>

**1. Select fabric softener (if desired)**



**FABRIC SOFTENER**

Set this knob to Yes when adding fabric softener to the fabric softener dispenser.



Press **START/PAUSE** to begin wash cycle



Press the **START/PAUSE** button to start the wash cycle. When the cycle has finished, the Done indicator will light. Promptly remove garments after cycle has completed to avoid odor, reduce wrinkling, and prevent rusting of metal hooks, zippers, and snaps.

### **Adding garment(s)**

If you need to open the lid to add one or two missed garments: Press the **START/PAUSE** button. The lid will unlock once the washer movement has stopped. This may take several minutes if the load was spinning at high speed. Add garments, close lid, and press the **START/PAUSE** button again to restart the cycle.

**NOTE:** Washer will not fill with the lid open.

**IMPORTANT:** If lid is left open for more than 10 minutes, the water will pump out automatically.

### **Manual Soak**

If you would like to manually soak your garments at any time during the wash portion of the cycle, press the **START/ PAUSE** button and leave the lid closed. Once your desired soak time has elapsed, press the **START/PAUSE** button again to continue the cycle. As long as the lid remains closed, your soak time can be longer than 10 minutes. However, if the lid is opened during the soak and remains open for more than 10 minutes, the water will pump out automatically

## **USING YOUR DRYER**

**WARNING:** To reduce the risk of fire, electric shock, or injury to persons, read the Important Safety Instructions before operating this dryer. Before using your dryer, wipe the dryer drum with a damp cloth to remove dust from storing and shipping.

### **1. Clean the lint screen**

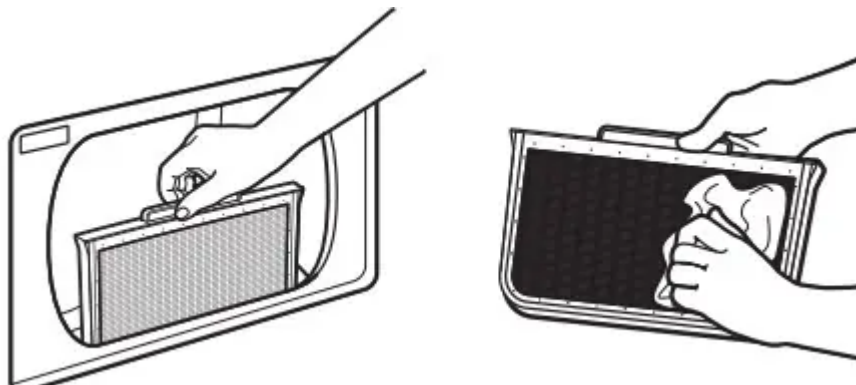

Clean the lint screen before each load. Pull the lint screen straight up. Roll lint off the screen with your fingers. Push the lint screen firmly back into place. Do not rinse or wash screen to remove lint. For additional cleaning information, see “Cleaning the lint screen.”

## 2. Load the dryer

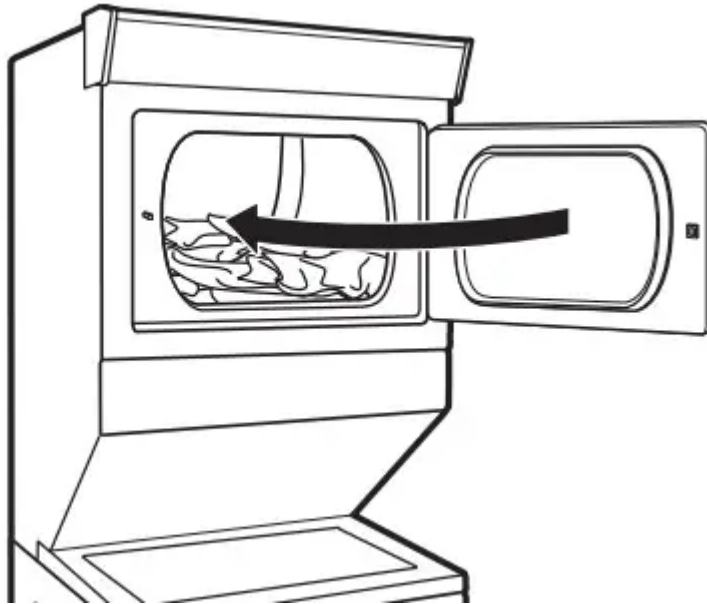

Place laundry in the dryer. Close the door.

**NOTE:** Your model may have a different door than the one shown. Do not tightly pack the dryer; clothes should be able to tumble freely

## 3. Select cycle

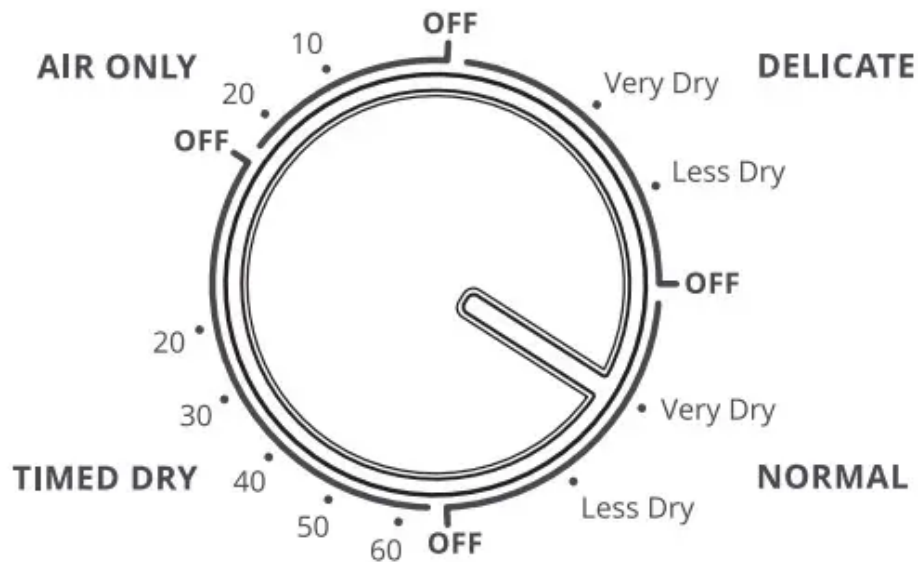

Select the desired cycle for your load. See “Dryer Cycle Guide” for more information about each cycle. Normal and Delicate Cycles You can select a different dryness level, depending on your load, by turning the knob to the desired dryness level. Selecting Very Dry or Less Dry automatically adjusts the dryness level at which the dryer will shut off. Once a dryness level is set, it cannot be changed without stopping the cycle. These

automatic dry cycles give the best drying in the shortest time. Drying time varies based on fabric type, load size, and dryness setting. NOTE: Very Dry removes more load moisture. Less Dry removes less moisture and is used for loads you may want to put on a hanger to complete drying

#### 4. Press **START** button to begin cycle



Press and hold the **START** button to begin the cycle. Promptly remove garments after cycle has completed to reduce wrinkling

### ADDITIONAL FEATURES

#### USING THE DRYING RACK

To obtain a drying rack for your dryer, see the “Accessories” section. Remove and discard any packing material before use. Use the drying rack for items that you do not want to tumble dry, such as sweaters and tennis shoes. When you use the drying rack, the drum continues to turn, but the rack remains stationary. The drying rack is intended for use with the Timed Dry cycles only. The drying rack cannot be used with Automatic Dry cycles.

#### To use the drying rack:

**IMPORTANT:** Do not remove the lint screen.

1. Open dryer door.

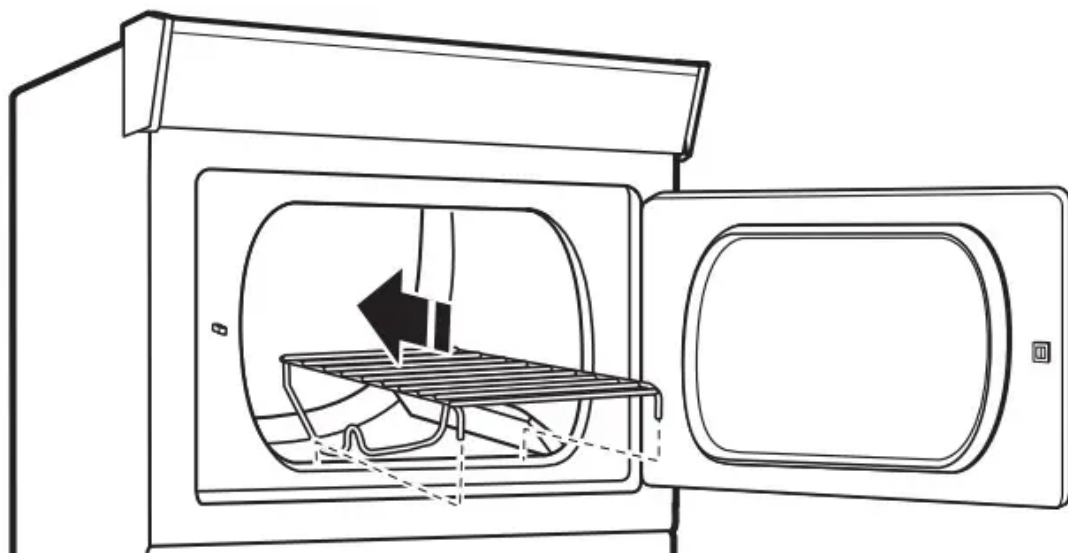

2. Align the two hooks on the front of the drying rack with the holes in the dryer door opening and press down fully into holes. Rest the rear support on the dryer back ledge.

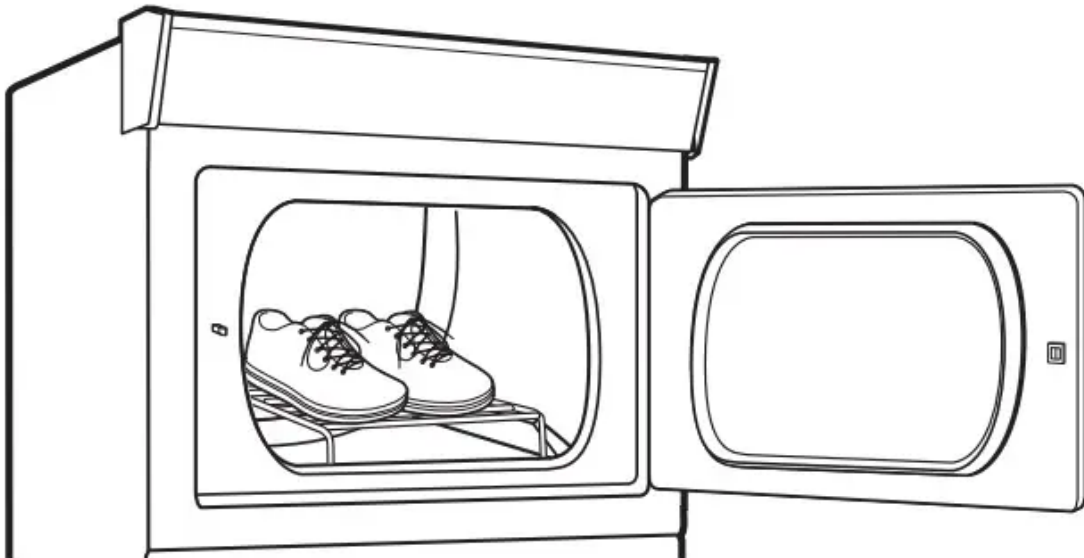

3. Place wet items on top of the drying rack. Allow space around items for air to circulate. The drying rack does not move, but the drum will rotate. Make sure items do not hang over the edges or between drying rack grille.
4. Close the door.
5. Select a Timed Dry/Air Only or Low Temperature cycle. Items containing foam, rubber, or plastic must be dried on a clothesline or by using the Air Only setting
6. Start the dryer.

**NOTE:** Check the lint screen and remove any lint accumulated from items dried on the drying rack after the cycle is finished.

## WASHER/DRYER MAINTENANCE

### WATER INLET HOSES

Replace inlet hoses after 5 years of use to reduce the risk of hose failure. Periodically inspect and replace inlet hoses if bulges, kinks, cuts, wear, or leaks are found. When replacing your inlet hoses, mark the date of replacement on the label with a permanent marker.

### WATER INLET HOSES

#### Recommendations to Help Keep Your Washer Clean and Performing at Its Best

1. Always use High Efficiency detergents and follow the detergent manufacturer's instructions regarding the amount of detergent to use. Never use more than the recommended amount because that may increase the rate at which detergent and soil residue accumulate inside your washer, which in turn may result in undesirable odor.

2. Use warm and hot wash water settings sometimes (not exclusively cold water washes), because they do a better job of controlling the rate at which soils and detergent accumulate.
3. Always leave the washer lid open between uses to help dry out the washer and prevent the buildup of odor-causing residue.

### **Cleaning Your Top-Loading Washer**

Read these instructions completely before beginning the routine cleaning processes recommended below. This Washer Maintenance Procedure should be performed, at a minimum, once per month or every 30 wash cycles, whichever occurs sooner, to control the rate at which soils and detergent may otherwise accumulate in your washer.

### **Cleaning the Inside of the Washer**

To keep your washer odor-free, follow the usage instructions provided above and use this recommended monthly cleaning procedure:

### **Recommended Cycle for Cleaning the Washer**

Refer to the "Cycle Guide" for the optimal cycle for cleaning the inside of the washer. Use this cycle with affresh® Washer Cleaner or liquid chlorine bleach as described below.

Begin procedure affresh® Washer Cleaner Cycle procedure (Recommended for Best Performance):

- a. Open the washer lid and remove any clothing or items.
- b. Use an affresh® Machine Cleaning Wipe or a soft, damp cloth or sponge to clean the inside of the door.
- c. Place an affresh® Washer Cleaner tablet in the bottom of the washer basket.
- d. Do not add any detergent or other chemical to the washer when following this procedure.
- e. Close the washer lid.
- f. Select the Clean Washer with affresh® cycle.
- g. Press and hold START/PAUSE to begin the cycle.

**NOTE:** For best results, do not interrupt cycle. If cycle must be interrupted, press the START/PAUSE button once. After the cycle has stopped, run a Quick Wash cycle to rinse cleaner from washer.

### **Chlorine Bleach Procedure (Alternative):**

- a. Open the washer lid and remove any clothing or items.
- b. Add 1 cup (236 mL) of liquid chlorine bleach to the bleach compartment.

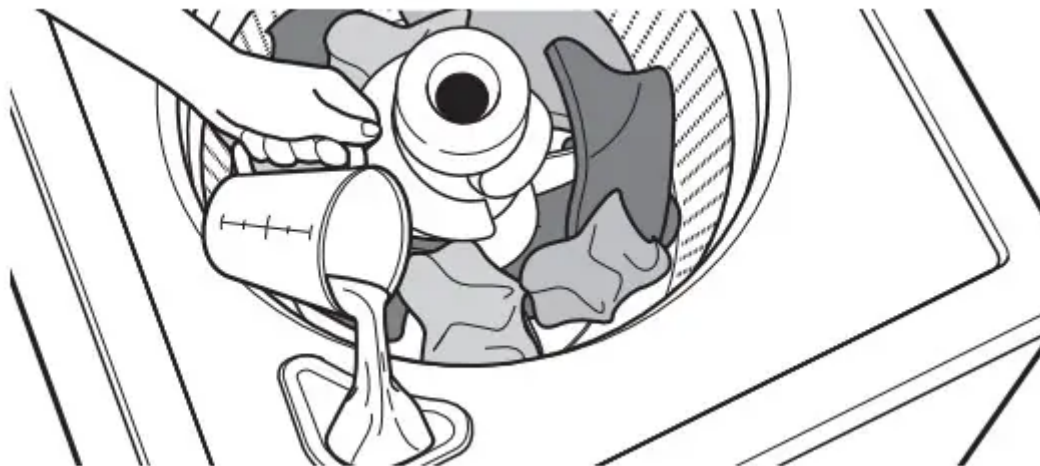

**NOTE:** Use of more liquid chlorine bleach than is recommended above could cause washer damage over time.

- c. Close the washer lid.
- d. Do not add any detergent or other chemical to the washer when following this procedure.
- e. Select the Clean Washer with affresh® cycle.
- f. Press and hold START/PAUSE to begin the cycle.

**NOTE:** For best results, do not interrupt cycle. If cycle must be interrupted, press the START/PAUSE button once. After the cycle has stopped, run a Quick Wash cycle to rinse cleaner from washer.

#### **Description of Clean Washer with affresh® Cycle Operation:**

1. The Clean Washer with affresh® cycle will determine whether clothing or other items are in the washer.
2. If no items are detected in the washer, it will proceed with the cycle. After the cycle is complete, leave the lid open to allow for better ventilation and drying of the washer interior.

#### **Cleaning the liquid fabric softener dispenser (on some models)**

1. Remove dispenser by grasping top with both hands and squeezing, while pushing upward with thumbs.
2. Rinse dispenser under warm water or wipe the surfaces with an affresh® Machine Cleaning Wipe or a damp cloth and towel dry either before or after you run the Clean Washer with affresh® cycle. Use an all-purpose surface cleaner, if needed.
3. Replace the dispenser.

**NOTE:** To avoid damage to the washer or clothing, do not wash clothes with the liquid fabric softener dispenser removed.

#### **Cleaning the bleach dispenser (on some models)**

Wipe the inside of the bleach dispenser with an affresh® Machine Cleaning Wipe or a clean, damp cloth. Use an all-purpose surface cleaner, if needed.

### **Cleaning the Outside of the Washer**

Use an affresh® Machine Cleaning Wipe or a soft, damp cloth or sponge to wipe away any spills. Use an affresh® Machine Cleaning Wipe or only mild soaps or cleaners when cleaning external washer surfaces.

**IMPORTANT:** To avoid damaging the washer's finish, do not use abrasive products.

## **CLEANING THE WASHER/DRYER LOCATION**

Keep washer/dryer area clear and free from items that would block the airflow for proper washer/dryer operation. This includes clearing piles of laundry in front of the washer/ dryer.

## **CLEANING THE DRYER INTERIOR**

### **To clean dryer drum**

1. Apply a liquid, nonflammable household cleaner to the stained area of the drum and rub with a soft cloth until stain is removed.
2. Wipe drum thoroughly with a damp cloth.
3. Tumble a load of clean cloths or towels to dry the drum.

**NOTE:** Garments that contain loose dyes, such as denim blue jeans or brightly colored cotton items, may discolor the dryer interior. These stains are not harmful to your dryer and will not stain future loads of clothes. Dry these items inside out to avoid drum staining.

## **REMOVING ACCUMULATED LINT**

### **From inside the dryer cabinet**

Lint should be removed every 2 years, or more often, depending on dryer usage. Cleaning should be done by a qualified servicer.

### **From the exhaust vent**

Lint should be removed every 2 years, or more often, depending on dryer usage.

## **CLEANING THE LINT SCREEN**

### **Every load cleaning**

A screen blocked by lint can increase drying time. The lint screen is located in the door opening of the dryer.

### To clean:

1. Pull the lint screen straight up. Roll lint off the screen with your fingers.

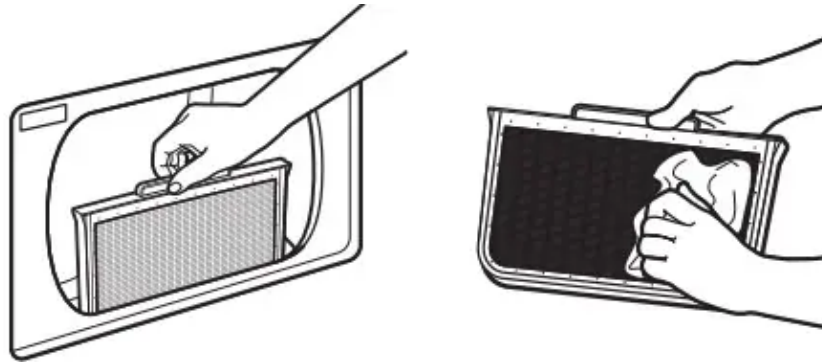

Do not rinse or wash the screen to remove lint. Wet lint is hard to remove.

2. Push the lint screen firmly back into place.

### IMPORTANT:

- Do not run the dryer with the lint screen loose, damaged, blocked, or missing. Doing so can cause overheating and damage to both the dryer and fabrics.
- If lint falls off the screen into the dryer during removal, check the exhaust hood and remove the lint. See “Venting Requirements” in the Installation Instructions.

### As-needed cleaning

Laundry detergent and fabric softener residue can build up on the lint screen. This buildup can cause longer drying times for your clothes, or cause the dryer to stop before your load is completely dry. The screen is probably clogged if lint falls off while the screen is in the dryer. Clean the lint screen with a nylon brush every 6 months, or more frequently, if it becomes clogged due to a residue buildup.

### To wash:

1. Roll lint off the screen with your fingers.
2. Wet both sides of lint screen with hot water.
3. Wet a nylon brush with hot water and liquid detergent. Scrub lint screen with the brush to remove residue buildup.



4. Rinse screen with hot water.
5. Thoroughly dry lint screen with a clean towel. Reinstall screen in dryer.

### **CHANGING THE DRUM LIGHT (on some models)**

1. Unplug dryer or disconnect power.
2. Open the dryer door. Locate the light bulb cover on the back wall of the dryer. Using a Phillips-head screwdriver, remove the screw located in the lower right-hand corner of the cover. Remove the cover.

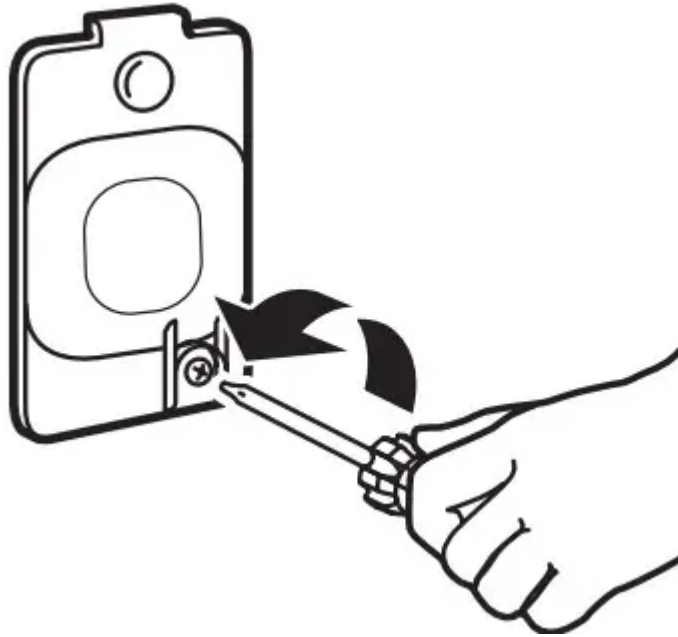

3. Turn bulb counterclockwise. Replace the bulb with a 10-watt appliance bulb only. Replace the cover and secure with the screw.
4. Plug into a grounded outlet or reconnect power.

### **VACATION, STORAGE, AND MOVING CARE**

#### **Non-Use or Storage Care**

Operate your washer/dryer only when you are at home. If you will be on vacation or not using your washer/dryer for an extended period of time, you should:

1. Unplug washer/dryer or disconnect power.
2. Turn off water supply to washer, to avoid flooding due to water pressure surge.
3. For gas dryers only: Close shut-off valve to gas supply line.
4. Clean lint screen. See "Cleaning the Lint Screen".

#### **Moving Care**

For power supply cord-connected washer/dryers:

1. Unplug the power supply cord.

2. Make sure leveling legs are secure in washer/dryer base.
3. Continue with “For all washer/dryers” in next column.

**For direct-wired washer/dryers:**

1. Turn off power at fuse or breaker box.
2. Disconnect wiring.
3. Make sure leveling legs are secure in washer/dryer base.
4. Continue with “For all washer/dryers” below.

**For gas washer/dryers:**

1. Unplug or disconnect power to washer/dryer.
2. Close shut-off valve in gas supply line.
3. Disconnect gas supply line pipe and remove fittings attached to dryer pipe.
4. Cap the open fuel supply line.
5. Make sure leveling legs are secure in washer/dryer base.
6. Continue with “For all washer/dryers” below.

**For all washer/dryers:**

1. Shut off both water faucets. Disconnect and drain water inlet hoses.
2. If washer/dryer will be moved during freezing weather, follow “Winter Storage Care” directions before moving.
3. Disconnect drain hose from drain system and drain any remaining water into a pan or bucket. Disconnect drain hose from back of washer.
4. Place inlet hoses and drain hose inside washer basket.
5. Drape power cord over edge and into washer basket.
6. Place packing tray from original shipping materials back inside washer/dryer. If you do not have packing tray, place heavy blankets or towels into basket opening. Close lids/doors and place tape over lids/doors and down front of washer/dryer. Keep lids/doors taped until washer/dryer is placed in new location.

## **WINTER STORAGE CARE**

**IMPORTANT:** To avoid damage, install and store washer/dryer where it will not freeze. Because some water may stay in hoses, freezing can damage washer/dryer. If storing or moving during freezing weather, winterize your washer/dryer.

**To winterize washer/dryer:**

1. Shut off both water faucets, disconnect and drain water inlet hoses.

2. Put 1 qt. (1 L) of R.V.-type antifreeze in basket and run washer on Quick Wash cycle for about 30 seconds to mix antifreeze and remaining water.
3. Unplug washer/dryer or disconnect power.

## **REINSTALLING/USING WASHER/DRYER AGAIN**

### **To reinstall washer/dryer after non-use, vacation, moving, or winter storage:**

1. Refer to Installation Instructions to locate, level, and connect washer/dryer.
2. Before using again, run washer/dryer through the following recommended procedure:

### **To use washer/dryer again:**

1. Flush water pipes and hoses. Reconnect water inlet hoses.  
Turn on both water faucets. continued in next column)

#### **In the U.S.A. and Canada**

2. Plug in washer/dryer or reconnect power.
3. Run washer through Bulky Items cycle to clean washer and remove antifreeze, if used.  
Use only HE High Efficiency detergent. Use half the manufacturer's recommended amount of detergent for a medium-size load.

## TROUBLESHOOTING – WASHER

If you experience	Possible Causes	Solution
<b>Vibration or Off-Balance</b>		
Check the following for proper installation or see “Using Your Washer” section.	Feet may not be in contact with the floor and locked.	Front and rear feet must be in firm contact with floor, and washer/dryer must be level to operate properly. Jam nuts must be tight against the bottom of the cabinet.
	Washer/dryer may not be level.	Check floor for flexing or sagging. If flooring is uneven, a 3/4" (19 mm) piece of plywood under your washer/dryer will reduce sound.
		See “Level the Washer/Dryer” in Installation Instructions
	Load could be unbalanced.	Load dry items in loose heaps evenly around basket wall. Adding wet items to washer or adding more water to basket could unbalance washer.
		Do not tightly pack. Avoid washing single items
		Use Bulky Items cycle for oversized, non-absorbent items such as jackets and small comforters. See “Cycle Guide.”  See “Washer Cycle Guide” and “Using Your Washer” in this Use and Care Guide.
<b>Noises</b>		
Clicking or metallic noises	Objects caught in washer drain system	Empty pockets before washing. Loose items such as coins could fall between basket and tub or may block pump. It may be necessary to call for service to remove items.

		It is normal to hear metal items on clothing such as metal snaps, buckles, or zippers touch against the stainless steel basket.
Gurgling or humming	Washer may be draining water.	It is normal to hear the pump making a continuous humming sound with periodic gurgling or surging as final amounts of water are removed during the Drain & Spin cycle.
Humming	Load sensing may be occurring.	You may hear the hum of the sensing spins after you have started the washer. This is normal.
Whirring	Basket deceleration may be occurring.	You may hear the whirring sound of the basket decelerating. This is normal.
<b>Water Leaks</b>		
Check the following for proper installation:	Washer not level.	Water may splash off basket if washer is not level. Check that load is not unbalanced or tightly packed.
	Fill hoses not attached tightly	Tighten fill-hose connection.
	Fill hose washers.	Make sure all four fill hose flat washers are properly seated.
	Drain hose connection.	Pull drain hose from washer cabinet and properly secure it to drainpipe or laundry tub.
		Do not place tape over drain opening.
	Check household plumbing for leaks or clogged sink or drain.	Water can back up out of a clogged sink or drainpipe. Check all household plumbing for leaks (laundry tubs, drain pipe, water pipes, and faucets.)

	Washer not loaded as recommended.	Improper loading can cause basket to be out of alignment and cause water to splash off tub. See “Using Your Washer” for loading instructions.
<b>Washer not performing as expected</b>		
Not enough water in washer	Load not completely covered in water.	Use Bulky Items cycle for higher water fill. See “Cycle Guide” to match your load with the best cycle.
Washer won't run or fill, washer stops working, or wash light remains on (indicating that the washer was unable to fill appropriately)	Check for proper water supply	Run Clean Washer with affresh® cycle to optimize the water level and wash performance due to soil buildup in washer basket.
		Both hoses must be attached and have water flowing to inlet valve.
		Both hot and cold water faucets must be turned on.
		Check that inlet valve screens have not become clogged.
		Check for any kinks in inlet hoses, which can restrict water flow
Check proper electrical supply.		Plug into a grounded outlet or reconnect power.
		Do not use an extension cord.
		Ensure there is power to outlet.
		Reset a tripped circuit breaker. Replace any blown fuses. <b>NOTE:</b> If problems continue, contact an electrician.
Normal washer operation		Lid must be closed for washer to run.



		Washer will pause during certain phases of cycle. Do not interrupt cycle.
	Washer may be tightly packed	Remove several items and rearrange load evenly in basket. Close lid and press the START/ PAUSE button.
		Do not add more than one or two additional items after cycle has started to avoid tightly packing or unbalancing.
		Do not add more than one or two additional items after cycle has started to avoid tightly packing or unbalancing.
Washer not draining/ spinning, loads are still wet, or spin light remains on (indicating that the washer was unable to pump out water within 10 minutes)	Small items may have been caught in pump or between basket and tub, which can slow draining.	Empty pockets and use garment bags for small items.
	Used a cycle with a low spin speed.	Cycles with lower spin speeds remove less water than cycles with high spin speeds. Use the recommended cycle/spin speed for your garment. To remove extra water in the load, select Drain & Spin. Load may need to be rearranged to allow even distribution of the load in the basket.
	The washer may be tightly packed or unbalanced.	Tightly packing or unbalanced loads will not allow the washer to spin correctly, leaving the load wetter than normal. Evenly arrange the wet load for balanced spinning. Select the Drain & Spin cycle to remove excess water. See “Using

		Your Washer” for loading recommendations.
	Check plumbing for correct drain hose installation. Drain hose extends into standpipe farther than 4.5" (114 mm).	Check drain hose for proper installation. Use drain hose form and securely attach to drainpipe or tub. Do not tape over drain opening. Lower drain hose if the end is higher than 96" (2.4 m) above the floor. Remove any clogs from drain hose.
	Too much detergent causing suds to slow or stop draining and spinning.	Always measure and follow detergent directions for your load. To remove extra suds, select Quick Wash. Do not add detergent.
Water level seems too low, or the washer appears to not fill completely	The top of the agitator is much higher than the highest water level.	This is normal and necessary for clothes to move freely
Clothes not completely covered with water	This washer uses much less water than traditional top-load washers.	Clothes may not be completely covered with water
	This washer uses much less water than traditional top-load washers.	Wash a smaller load, or run the Heavy Duty cycle
	High spin speeds extract more moisture than traditional top-load washers.	The high spin speeds combined with airflow during the final spin can cause items near the top of the load to develop dry spots during the final spin. This is normal.
	Washer may be tightly packed.	Use the Bulky Items cycle for a higher water fill. See “Cycle Guide” to match your load with the best cycle.

	Added extra garments to the load after the sensing/fill phase.	Add only one or two additional garments after washer has started
Incorrect or wrong wash or rinse temperatures	Check for proper water supply.	Check that hot and cold inlet hoses are not reversed
		Both hoses must be attached to both washer and faucet, and have both hot and cold water flowing to inlet valve.
		Check that inlet valve screens are not clogged.
		Remove any kinks in hoses
	Energy-saving controlled wash temperatures.	This washer uses cooler wash and rinse water temperatures than your previous washer. This includes cooler hot and warm washes.
Load not rinsed	Check for proper water supply	Check that hot and cold inlet hoses are not reversed.
		Both hoses must be attached and have water flowing to the inlet valve.
		Both hot and cold water faucets must be on. Inlet valve screens on washer may be clogged
		Remove any kinks in the inlet hose.
	Not using HE detergent or using too much HE detergent.	The suds from too much detergent can keep washer from operating correctly. Always measure detergent and follow detergent directions based on load size and soil level.



	Washer not loaded as recommended.	<p>The washer is less efficient at rinsing when load is tightly packed.</p> <p>Load garments in loose heaps evenly around the basket wall. Load with dry items only.</p> <p>The washer will not rinse well if tightly packed. Load with dry items only</p> <p>Use cycle designed for the fabrics being washed.</p> <p>Add only one or two garments after washer has started.</p>
Residues remaining on the load after washing	Sand, pet hair, lint, remaining detergent, bleach, and other residues may require additional rinsing.	Select the Heavy Duty cycle.
Load is tangling	Washer not loaded as recommended	<p>See “Using Your Washer” section.</p> <p>Select a cycle with a slower wash action and spin speed; however, items will be wetter than those using a higher speed spin.</p> <p>Load garments in loose heaps evenly around the basket wall.</p> <p>Reduce tangling by mixing types of load items. Use the recommended cycle for the type of garments being washed.</p>
Not cleaning or removing stains	Added more water to washer.	Washer senses load size and adds correct amount of water. This is normal and necessary for clothes to move. It is normal for the wash load to be below the water line. Extra



	water, added manually, results in less effective cleaning.
Washer not loaded as recommended.	Washer is less efficient at cleaning when load is tightly packed.
	Load garments in loose heaps evenly around the basket wall. Load with dry items only.
	Add only one or two garments after washer has started.
Adding detergent on top of load	Add detergent, Oxi products, and color-safe bleach to the bottom of the basket before adding the load items.
Not using HE detergent or using too much HE detergent	The suds from too much detergent can keep washer from operating correctly
	Use only HE detergent. Be sure to measure correctly.
	Always measure detergent and follow manufacturer's directions based on load size and soil level.
Not using correct cycle for fabric type.	Use a higher soil level cycle option and warmer wash temperature to improve cleaning.
	Use Heavy Duty cycle for tough cleaning. See the "Cycle Guide" to match your load with the best cycle.
Not using dispensers.	Use dispensers to avoid chlorine bleach and fabric softener staining.
	Load dispensers before starting a cycle
	Avoid overfilling



		Do not add products directly to load
	Not washing like colors together.	Wash like colors together and remove promptly after the cycle is complete to avoid dye transfer.
Incorrect dispenser operation	Clogged dispenser	Use only liquid chlorine bleach in the bleach dispenser. Use only fabric softener in the fabric softener dispenser.
Fabric damage	Sharp items were in pockets during wash cycle.	Empty pockets, zip zippers, and snap or hook fasteners before washing to avoid snags and tears.
	Strings and straps could have tangled.	Tie all strings and straps before starting wash load.
	Items may have been damaged before washing.	Mend rips and broken threads in seams before washing.
	Fabric damage can occur if load is tightly packed.	Load garments in loose heaps evenly around the basket wall. Load with dry items only.
		Use cycle designed for the fabrics being washed.
		Add only one or two additional garments after washer is started
	Liquid chlorine bleach may have been added incorrectly	Do not pour liquid chlorine bleach directly onto load. Wipe up bleach spills.
		Undiluted bleach will damage fabrics. Do not use more than recommended by manufacturer.
		Do not place load items on top of bleach dispenser (on some models) when loading and unloading washer.



	Garment care instructions may not have been followed.	Always read and follow garment manufacturer's care label instructions. See the "Cycle Guide" to match your load with the best cycle.
Odors	Monthly maintenance not done as recommended.	See "Washer Care" in "Washer/Dryer Maintenance."  Unload washer as soon as cycle is complete.
	Using too much detergent.	Be sure to measure correctly. Always follow the manufacturer's directions.
		See "Washer Care" section.
Lid Lock light is flashing	The lid is not closed.	Close the lid. The washer will not start with the lid open.
	A cycle was stopped or paused using the Start/Pause button.	The washer may still be spinning. The lid will not unlock until the basket has stopped spinning. This may take several minutes if washing large loads or heavy fabrics.
Single-dose laundry packet not dissolving	Adding laundry packet incorrectly	Be sure laundry packet is added to washer basket before adding clothes. Do not add packet to dispenser. Follow the manufacturer's instructions to avoid damage to your garments.
Washer pumps out water before finishing cycle	Lid is left open for more than 10 minutes.	Make sure lid is closed before starting a cycle and/or during prewash (soak).
Dryer not performing as expected		
Clothes are not drying satisfactorily, drying times are too long	Lint screen clogged with lint	Lint screen should be cleaned before each load

Exhaust vent or outside exhaust hood clogged with lint, restricting air movement.	Run the dryer for 5–10 minutes. Hold your hand under the outside exhaust hood to check air movement. If you do not feel air movement, clean exhaust system of lint or replace exhaust vent with heavy metal or flexible metal vent. Make sure vent is not crushed or kinked. See Installation Instructions
The Air Only cycle has been selected	Select the correct cycle for the types of garments being dried. See “Dryer Cycle Guide
Load too large and heavy to dry quickly	Separate the load to tumble freely
Fabric softener sheets blocking the grille.	Use only one fabric softener sheet, and use it only once.
Exhaust vent not the correct length	Check that the exhaust vent is not too long or has too many turns. Long venting will increase drying times. Make sure vent is not crushed or kinked. See Installation Instructions.
Exhaust vent diameter not the correct size.	Use 4" (102 mm) diameter vent material.
Dryer located in a room with temperature below 45°F (7°C).	Proper operation of dryer cycles requires temperatures above 45°F (7°C).
Dryer located in a closet without adequate opening.	Closet doors must have ventilation openings at the top and bottom of the door. The front of the dryer requires a minimum of 1" (25 mm) of airspace, and, for most installations, the rear of the dryer

		requires 5" (127 mm). See Installation Instructions.
Dryer will not run	Door not closed completely	Make sure the dryer door is closed completely
	Start button not pressed firmly or held long enough.	Press and hold the START button until you hear the dryer drum moving
	Household fuse is blown or circuit breaker has tripped.	Electric dryers use two household fuses or circuit breakers. The drum may be turning, but you may not have heat. Replace both fuses or reset the circuit breaker. If the problem continues, call an electrician.
	Incorrect power supply.	Electric dryers require 240 volt power supply. Check with a qualified electrician
	Wrong type of fuse	Use a time-delay fuse.
Unusual sounds	Dryer had a period of non-use.	If the dryer hasn't been used for a while, there may be a thumping sound during the first few minutes of operation.
	A coin, button, or paper clip is caught between the drum and front or rear of the dryer.	Check the front and rear edges of the drum for small objects. Clean out pockets before laundering.
	It is a gas dryer.	The gas valve clicking is a normal operating sound.
	The dryer is not level front to back and side to side.	The dryer may vibrate if not properly installed. See Installation Instructions.
	Clothing knotted or balled up.	When balled up, the load will bounce, causing the dryer to

		vibrate. Separate the load items and restart the dryer.
No heat	Household fuse is blown or circuit breaker has tripped.	The drum may be turning, but you may not have heat. Electric dryers use two household fuses or circuit breakers. Replace both fuses or reset the circuit breaker. If the problem continues, call an electrician
	Supply line valve not open.	For gas dryers, the valve is not open on the supply line.
	Incorrect power supply.	Electric dryers require 240 volt power supply. Check with a qualified electrician
Cycle time too short	Automatic cycle ending early.	Some models: The load may not be contacting the sensor strips. Level the dryer.
		Use Timed Drying for very small loads. Change the Dryness Level setting on the Normal and Delicate cycles. Increasing or decreasing the Dryness Level setting will change the amount of drying time in a cycle
Lint on load	Lint screen clogged.	Lint screen should be cleaned before each load
Stains on load or drum	Dryer fabric softener not properly used	Add dryer fabric softener sheets at the beginning of the cycle. Fabric softener sheets added to a partially dried load can stain your garments.
		Drum stains are caused by dyes in clothing (usually blue jeans). These will not transfer to other clothing.
Loads are wrinkled	Load not removed from dryer at the end of the cycle	Run the Air Only cycle to tumble the load without heat to avoid wrinkling.

	Dryer tightly packed.	Dry smaller loads that can tumble freely to reduce the chance of wrinkles forming.
Odors	You have recently been painting, staining, or varnishing in the area where your dryer is located.	Ventilate the area. When the odors or fumes are gone from the area, rewash and dry the clothing.
	The dryer is being used for the first time.	The new electric heating element may have an odor. The odor will be gone after the first cycle.
Load is too hot	Laundry items were removed from the dryer before the end of the cycle.	All cycles are cooled slowly to reduced wrinkling and make it easier to handle. Items removed before the cool down may feel very warm.
	A high temperature cycle was used	Select a lower temperature, and use an automatic drying cycle. These cycles sense the temperature or the moisture level in the load and shut off when the load reaches the selected dryness. This reduces overdrying.
	Exhaust vent or outside exhaust hood clogged with lint, restricting air movement	Run the dryer for 5–10 minutes. Hold your hand under the outside exhaust hood to check air movement. If you do not feel air movement, clean exhaust system of lint or replace exhaust vent with heavy metal or flexible metal vent. Make sure vent is not crushed or kinked. See Installation Instructions.

**Warning**



This content is compiled from multiple sources and is provided for reference purposes only. It may not be complete or fully applicable to all situations. If you are unable to resolve your issue, please contact the product manufacturer or an authorized service provider for official support.

---

Document generated by [ManualsFile](#)

