

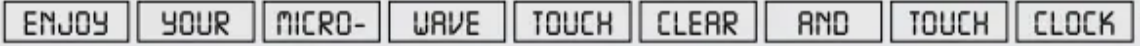

## Before Operating

Before operating your new DrawerMicro Oven make sure you read and understand this Use and Care Guide completely. The following steps MUST be taken before any functions can be used.

Before you use the DrawerMicro Oven:

1. Plug in the DrawerMicro Oven.

 will appear.

2. Touch the Stop/Clear pad.  will appear.

3. Set clock.

### To Set The Clock

1. Touch Timer/Clock pad and number .
2. Enter the correct time of day by touching the numbers in sequence. Touch Timer/Clock pad. This is a 12 hour clock.

If you attempt to enter an incorrect clock time,  will appear in the display. Touch the Stop/Clear pad and re-enter the time

- If the electrical power supply to your DrawerMicro Oven should be interrupted, the display will intermittently show



after the power is reinstated. If this occurs during cooking, the program will be erased. The time of day will also be erased. Simply touch Stop/Clear pad and reset the clock for the correct time of day.

### Stop/Clear

Touch the Stop/Clear pad to:

1. Erase if you make a mistake during programming.
2. Cancel timer.
3. Stop the oven temporarily during timed cooking.
4. Return the time of day to the display.
5. Cancel a program during cooking, touch twice.

## Open Or Close DrawerMicro Oven

Always Touch the OPEN or CLOSE pad on the control panel to open or close the DrawerMicro Oven.

Do not push or pull the drawer by hand, except in case of emergency, such as a power failure. If necessary, push or pull slowly.

## Features

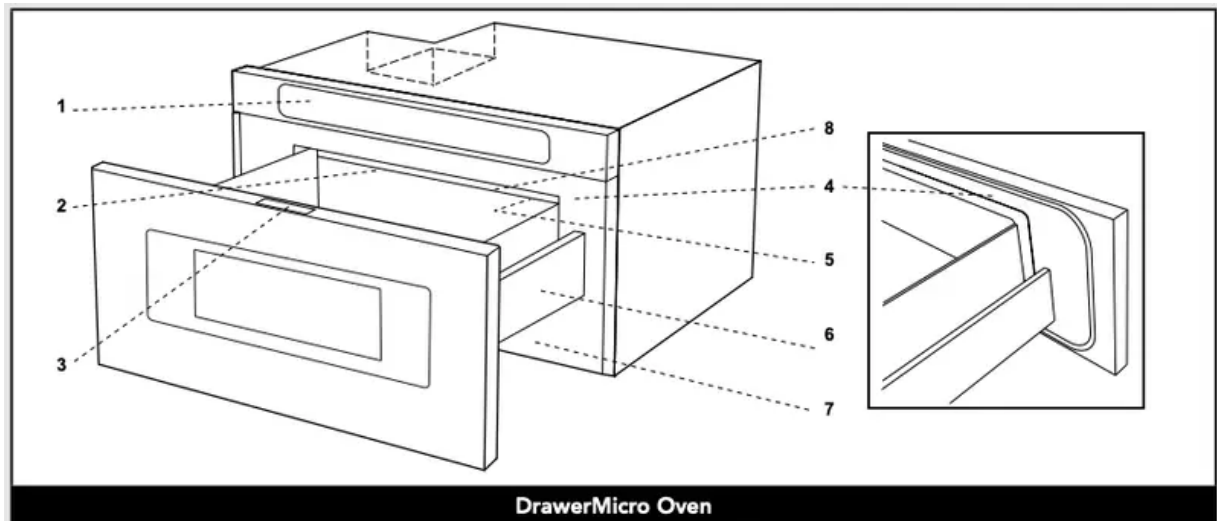

1 Control panel

2 Waveguide cover DO NOT REMOVE

3 DrawerMicro Oven Menu Label

4 Drawer sealing surfaces

5 Drawer light

6 DrawerMicro Oven guides

7 Vent

8 Name plate: open the DrawerMicro Oven fully. The label is beyond the back wall of the microwave cavity facing up from the flat surface.

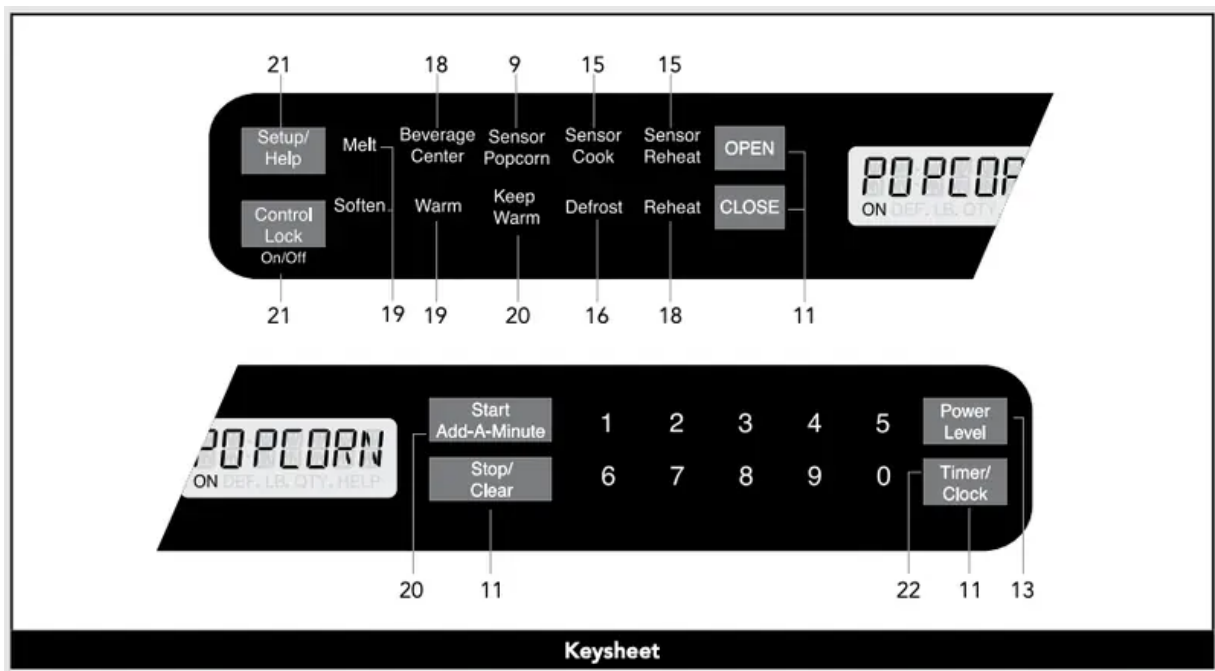

Numbers next to the keysheet illustration indicate pages on which there are feature descriptions and usage information.

## Control Panel and Settings

### Time Cooking

Your DrawerMicro Oven can be programmed for 99 minutes 99 seconds (99.99). Always enter the seconds after the minutes, even if they are both zeros.

- **Cook for 5 minutes at 100%**

1. Enter cooking time **5 0 0**.
2. Touch Start/Add-A-Minute pad.

### To Set Power Level

There are eleven preset power levels. Using lower power levels increases the cooking time, which is recommended for foods such as cheese, milk and long slow cooking of meats. Consult a microwave cookbook or recipes for specific recommendations.

- **Defrost for 5 minutes at 30%**

1. Enter defrost time **5 0 0**.
2. Touch Power Level 8 times.
3. Touch Start/Add-A-Minute.

<b>Touch Power Level pad number of times for desired power</b>	<b>Approximate percentage of power</b>	<b>Common words for power levels</b>
Power Level x 1	100%	High
Power Level x 2	90%	
Power Level x 3	80%	
Power Level x 4	70%	Medium High
Power Level x 5	60%	
Power Level x 6	50%	Medium
Power Level x 7	40%	
Power Level x 8	30%	Med Low/Defrost
Power Level x 9	20%	
Power Level x 10	10%	Low
Power Level x 11	0%	

## Sensor Settings

Sensor is a semi-conductor device that detects the vapor (moisture and humidity) emitted from the food as it heats. The sensor adjusts the cooking times and power levels for various foods and quantities.

- After the oven is plugged in, wait 2 minutes before using any sensor setting.
- Be sure the exterior of the cooking container and the interior of the oven are dry. Wipe off any moisture with a dry cloth or paper towel.
- The sensor works with foods at normal storage temperature. For example, popcorn would be at room temperature.
- Any sensor selection can be programmed with More or Less Time Adjustment. See page 21.
- More or less food than the quantity listed in the charts should be cooked following the guidelines in any microwave cookbook.
- During the first part of sensor use, the food name will appear on the display. Do not open the oven or touch Stop/ Clear during this part of the cycle. The measurement of vapor will be interrupted. If this occurs, an error message will appear. To continue cooking, touch the Stop/

Clear pad and cook manually. When the sensor detects the vapor emitted from the food, the remainder of cooking/reheating time will appear. The oven may be opened when the remaining time appears on the display. At this time, you may stir or season food, as desired.

- Except for Popcorn, if the sensor does not detect vapor properly when cooking other foods, **ERROR** will be displayed, and the microwave will turn off.
- Check food temperature after cooking. If additional time is needed, continue to cook manually.
- Each food has a cooking hint. Touch the Set Up/Help pad when the HELP indicator is lighted in the display.

## Covering Foods

Some foods work best when covered. Use the cover recommended in the charts for these foods. You may refer to the hints by touching the Set Up/Help pad. See page 21.

- Casserole lid
- Plastic wrap: Use plastic wrap recommended for microwave cooking. Cover dish loosely; allow approximately 1/2 inch to remain uncovered to allow steam to escape. Plastic wrap should not touch food.
- Wax paper: Cover dish completely. Fold excess wrap under dish to secure. If dish is wider than paper, overlap two pieces at least one inch to cover.

Be careful when removing any covering to allow steam to escape away from you.

## Sensor Popcorn / Sensor Reheat

You can pop popcorn and reheat many foods and don't need to calculate cooking time or power level.

Touch Sensor Reheat or Sensor Popcorn and Start/Add-A-Minute pad.

When the sensor detects the vapor emitted from the food, the remainder of cooking/reheating time will appear.

### NOTE:

- The Sensor Popcorn setting has 2 choices. Follow directions in the display to choose desired option.

### Sensor Popcorn / Sensor Reheat Chart

Food	Amount	Procedure
Sensor Popcorn	Only 1 package at a time  2.85 - 3.5 oz. (Regular / Regular light)  1.2 - 1.75 oz. (Mini / Snack)	Use only popcorn packaged for the microwave. Try several brands to decide which you like. Do not try to pop unpopped kernels.  Touch Sensor Popcorn pad once.  Touch Sensor Popcorn pad twice.
Sensor Reheat	4 - 36 oz	Place in dish or casserole slightly larger than amount to be reheated. Flatten, if possible. Cover with lid, plastic wrap or wax paper. Use covers such as plastic wrap or lids with larger quantities of more dense foods such as stews. After reheating, stir well, if possible. Re-cover and allow to stand 2 to 3 minutes. Foods should be very hot. If not, continue to heat with variable power and time.

## Sensor Cook



1. Touch Sensor Cook pad once.
2. See Menu Label. Select desired food by touching number pad. Ex: Touch 5 for baked potatoes.
3. Touch Start/Add-A-Minute pad.

### NOTE:

- To heat or cook other foods or foods above or below the quantity allowed on the Sensor Cook Chart, cook manually

### Sensor Cook Chart

Food	Amount	Procedure
<p>1. Fresh vegetables:</p> <p>Quick Broccoli</p> <p>Brussels sprouts</p> <p>Cabbage</p> <p>Cauliflower (flowerets)</p> <p>Cauliflower (whole)</p> <p>Spinach</p> <p>Zucchini</p> <p>Baked apples</p>	<p>25 - 2.0 lb.</p> <p>.25 - 2.0 lb.</p> <p>.25 - 2.0 lb.</p> <p>.25 - 2.0 lb.</p> <p>.25 - 2.0 lb.</p> <p>1 med.</p> <p>.25 - 1.0 lb.</p> <p>.25 - 2.0 lb.</p> <p>lb.</p> <p>2 - 4 med.</p>	<p>Wash and place in casserole. Add no water if vegetables have just been washed. Cover with lid for tender vegetables. Use plastic wrap for tendercrisp vegetables. After cooking, stir, if possible. Let stand, covered, for 2 to 5 minutes.</p>
<p>2. Fresh vegetables:</p> <p>Longer Carrots, sliced</p> <p>Corn on the cob</p> <p>Green beans</p> <p>Winter squash: diced halves</p>	<p>25 - 1.5 lb.</p> <p>2 - 4</p> <p>.25 - 1.5 lb.</p> <p>.25 - 1.5 lb.</p> <p>1 - 2</p>	<p>Place in casserole. Add 1-4 tablespoons water. Cover with lid for tender vegetables. Use plastic wrap cover for tender-crisp vegetables. After cooking, stir, if possible. Let stand, covered, for 2 to 5 minutes.</p>
<p>3. Frozen vegetables</p>	<p>.25 - 1.25 lb.</p>	<p>Add no water. Cover with lid or plastic wrap. After cooking, stir and let stand, covered, for 3 minutes.</p>
<p>4. Frozen entrees</p>	<p>6 - 17 oz.</p>	<p>Use this pad for frozen convenience foods. It will give satisfactory results for most brands. You may wish to try several and choose your favorite. Remove package from outer wrapping and follow package directions for covering. After cooking, let stand, covered, for 1-3 minutes</p>





5. Baked potatoes 6. Sweet potatoes	1 - 6 med. 1 - 6 med.	Pierce. Place on paper-towel-lined DrawerMicro Oven. After cooking, remove from microwave, wrap in aluminum foil and let stand 5 to 10 minutes.
7. Ground meat	.25 - 2.0 lb.	Use this setting to cook ground beef or turkey as patties or in a casserole to be added to other ingredients. Place patties on a microwave-safe rack and cover with wax paper. Place ground meat in a casserole and cover with wax paper or plastic wrap. When microwave stops, turn patties over or stir meat in casserole to break up large pieces. Re-cover and touch Start/AddA-Minute. After cooking, let stand, covered, for 2 to 3 minutes.
8. Fish/ Seafood	.25 - 2.0 lb.	Arrange in ring around shallow glass dish (roll fillet with edges underneath). Cover with vented plastic wrap. After cooking, let stand, covered for 3 minutes.
9. White rice 10. Brown rice	.5 - 2.0 cups .5 - 2.0 cups	Place rice into a deep casserole and add double quantity of water. Cover with lid or plastic wrap. After cooking, stir, cover and let stand 3 to 5 minutes or until all liquid has been absorbed.

Rice	Water	Size of casserole
.5 cup	1 cup	1.5 quart
1 cup	2 cups	2 quart
1.5 cups	3 cups	2.5 or 3 quart
2 cups	4 cups	3 quart or larger

## Defrost

Use this feature to defrost the foods shown in the Defrost Chart below.

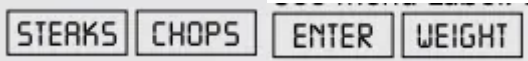
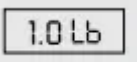
1. Touch Defrost pad. 
2. See Menu Label. Select desired food by touching the number pad. Ex: Touch  for steaks/chops. 
3. Enter weight by touching number keys. 

4. Touch Start/Add-A-Minute pad. The oven will stop so that the food can be checked.
5. After the first stage, open the DrawerMicro Oven. Turn steak over and shield any warm portions. Close the DrawerMicro Oven. Touch Start/Add-A-Minute pad.
6. After the second stage, open the DrawerMicro Oven. Shield any warm portions. Close the DrawerMicro Oven. Touch Start/Add-A-Minute pad.
7. After defrost cycle ends, cover and let stand as indicated in the chart on page 17.

**NOTE:**

- Defrost can be programmed with More or Less Time Adjustment. See page 21.
- To defrost other foods or foods above or below the weights allowed on the Defrost Chart, see Manual Defrost below.
- Check foods when oven signals. After final stage, small sections may still be icy. Let stand to continue thawing. Do not cook until all ice crystals are thawed.
- Shielding prevents cooking from occurring before the center of the food is defrosted. Use small smooth strips of aluminum foil to cover edges and thinner sections of the food.

**Defrost Chart**

Food	Amount	Procedure
1. Ground Meat	.5 - 2.0 lb.	Pull apart and remove any thawed pieces after each stage. Let stand, covered, for 5 to 10 minutes.
2. Steaks/ chops	.5 - 3.0 lb.	After each stage, rearrange and if there are warm or thawed portions, shield with small flat pieces of aluminum foil. Remove any meat or fish that is nearly defrosted. Let stand, covered, for 10 to 20 minutes.
3. Boneless poultry	.5 - 2.0 lb.	Use boneless breast of chicken or turkey. After each stage, if there are warm or thawed portions, rearrange or remove. Let stand, covered, for 10 to 20 minutes.
4. Bone-in poultry	.5 - 3.0 lb.	Arrange pieces with meatiest portions toward outside of glass dish or microwave safe rack. After each stage, if there are warm or thawed portions, rearrange or remove. Let stand, covered, for 10 to 20 minutes.
5. Roast	2.0 - 4.0 lb	Start defrosting with fat side down. After each stage, turn roast over and shield the warm portions with aluminum foil. Let stand, covered, for 30 to 60 minutes.



## Manual Defrost

If the food that you wish to defrost is not listed on the Defrost Chart or is above or below the limits in the amount column on the Defrost Chart, you need to defrost manually.

You can defrost any frozen food, either raw or previously cooked, by using Power Level at 30%. Follow the exact 3-step procedure found under To Set Power Level on page 13. Estimate defrosting time and Touch Power Level pad eight times for 30% power.

For either raw or previously cooked frozen food the rule of thumb is approximately 4 minutes per pound. For example, defrost 4 minutes for 1 pound of frozen spaghetti sauce.

Always stop the oven periodically to remove or separate the portions that are defrosted. If food is not defrosted at the end of the estimated defrosting time, program the oven in 1 minute increments on Power Level 30% until totally defrosted.

When using plastic containers from the freezer, defrost only long enough to remove from the plastic in order to place in a microwave-safe dish.

## Reheat

Reheat automatically computes the correct warming time and microwave power level for foods shown in the chart below.



1. Touch Reheat pad once.
2. See Menu Label. Select desired food by touching number pad. Ex: Touch 2 for frozen rolls or muffins.
3. Touch the number pad to select quantity. Ex: Touch 2 for 2 rolls or muffins.
4. Touch Start/Add-A-Minute pad.

### NOTE:

- Reheat can be programmed with More or Less Time Adjustment. See page 21.
- To reheat other foods or foods above or below the quantity allowed on the Reheat Chart, heat manually

## Reheat Chart

Food	Amount	Procedure
1. Fresh Rolls/ Muffins	1 - 8 pcs	Use this pad to warm rolls, muffins, biscuits, bagels etc. Large items should be considered as 2 or 3 regular size. Arrange on plate; cover with paper towel. For refrigerated rolls or muffins, it may be necessary to double the entered amount to ensure the proper serving temperature. For example, enter quantity of 2 for 1 refrigerated muffin.
2. Frozen Rolls/ Muffins	1 - 8 pcs	Use this pad to warm frozen rolls, muffins, biscuits, bagels etc. Large items should be considered as 2 or 3 regular size. Arrange on plate; cover with paper towel.

## Beverge Center

Beverage Center enables you to reheat coffee or tea to restore to a more suitable drinking temperature or to make instant coffee or tea.



1. Touch Beverage Center pad once.
2. See Menu Label. Select desired selection by touching number pad. Ex: Touch 2 to make coffee.
3. Repeating touching same number pad to select quantity. Ex: Touch 2 two more times for 2 cups of coffee.
4. Touch Start/Add-A-Minute pad.

### NOTE:

- Beverage Center can be programmed with More or Less Time Adjustment. See page 21.
- Should you attempt to enter more or less than the allowed amount, an error message will appear in the display.

### Beverage Center Chart

Food	Amount	Procedure
1. Reheat beverage	.5 - 2.0 cups	This setting for good for restoring cooled beverage to a better drinking temperature. Touch number 1 pad for a 0.5 cup increase per touch. Stir after heating.
2. Hot water	1 - 6 cups	Use this setting for heating COLD TAP WATER to a temperature somewhat below the boiling point to make instant coffee or tea. Touch number 2 pad for 1 cup increase per touch. Stir liquid briskly before and after heating to avoid "eruption".

## Melt/Soften/Warm

Melt, Soften and Warm automatically compute the correct heating time and microwave power level for melting, softening and warming foods shown in the chart below.



1. Touch Melt pad once.
2. See Menu Label. Select desired food by touching number pad. Ex: Touch 2 for chocolate.
3. Repeat touching same number pad to select quantity. Ex: Touch 2 two more times for 1 square.
4. Touch Start/Add-A-Minute pad.

### NOTE:

- Melt, Soften and Warm can be programmed with More or Less Time Adjustment. See page 21.
- To melt, soften or warm other food or foods above or below the quantity allowed on the MELT/SOFTEN/WARM CHART, use manual operation.

**Melt/Soften/Warm Chart**

Food	Amount	Procedure
Melt 1. Butter 2. Chocolate	2 tbsp .5 cup 1 cup chips 1 square	Use a Pyrex measuring cup. Cover with plastic wrap. After touching Melt, touch <b>1</b> two times for 2 tbsp. After touching Melt, touch <b>1</b> three times for .5 cup. After touching Melt, touch <b>2</b> two times for 1 cup chips. After touching Melt, touch <b>2</b> three times for 1 square.
Soften 1. Ice cream 2. Cream cheese	1 pint .5 gallon 3 oz. 8 oz.	DO NOT COVER. After touching Soften, touch <b>1</b> two times for 1 pint. After touching Soften, touch <b>1</b> three times for .5 gallon. After touching Soften, touch <b>2</b> two times for 3 oz. After touching Soften, touch <b>2</b> three times for 8 oz.
Warm 1. Syrup 2. Dessert toppings	1/4 cup 1/2 cup 1/4 cup 1/2 cup	Use a Pyrex measuring cup. DO NOT COVER. After touching Warm, touch <b>1</b> two times for 1/4 cup. After touching Warm, touch <b>1</b> three times for 1/2 cup. After touching Warm, touch <b>2</b> two times for 1/4 cup. After touching Warm, touch <b>2</b> three times for 1/2 cup.

## Keep Warm

Keep Warm allows you to keep food warm up to 30 minutes.

### Direct use

1. Touch Keep Warm pad.
  2. Enter desired time by touching the number keys. To enter 30 minutes, touch .
-

3. Touch Start/Add-A-Minute pad. The oven will start. The display will show 30.00 and count down.  will be displayed intermittently during the count down.

### With Manual Cooking

1. Enter desired cooking time and power level.
2. Touch Keep Warm pad.
3. Enter desired warming time up to 30 minutes.
4. Touch Start/Add-A-Minute pad. The operation will start. When the cooking time is complete, a long tone will sound and Keep Warm will start. The display will count down.  will be displayed intermittently during the count down.

### NOTE:

- If you attempt to enter more than 30 minutes for Keep Warm, an error message will appear in the display.
- Keep Warm cannot be programmed with Sensor Popcorn, Sensor Reheat, Sensor Cook, Defrost or Reheat.

### Multiple Sequence Cooking

Your DrawerMicro Oven can be programmed for up to 4 automatic cooking sequences, switching from one power level setting to another automatically. Sometimes cooking directions tell you to start on one power level and then change to a different power level. Your DrawerMicro Oven can do this automatically.

1. First enter cooking time. Then touch Power Level pad once for 100% cooking or repeat touching Power Level pad for a lower power level.
2. Enter second cooking time. Repeat touching Power Level pad for desired level. You can follow this procedure up to 4 times. 
3. Touch Start/Add-A-Minute pad.

### NOTE:

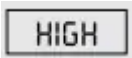
- If Power Level pad is touched once,  will be displayed.
- If 100% is selected as the final sequence, it is not necessary to touch the Power Level pad.
- If you wish to know power level during cooking, simply touch the Power Level pad. As long as your finger is touching the Power Level pad, the power level will be displayed.
- Keep Warm can be programmed even if 4 cooking sequences have been set.

## Add-A-Minute

Add-A-Minute allows you to cook for a minute at 100% by simply touching the Add-A-Minute pad. You can also extend cooking time in multiples of 1 minute by repeatedly touching the Add-A-Minute pad during manual cooking.

### NOTE:

- To use Add-A-Minute, touch pad within 3 minutes after cooking, closing the drawer or touching the Stop/Clear pad.
- Add-A-Minute cannot be used with Sensor settings, Reheat or Defrost.

## More or less time adjustment

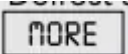
Should you discover that you like any of the Sensor, Reheat or Defrost settings slightly more done, touch the Power Level pad once after touching your selection. The display will show .

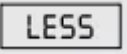
For slightly less done, touch the Power Level pad twice after touching your selection. The display will show .

## Help (In the display)

Each setting of Sensor Reheat, Sensor Cook, Sensor Popcorn, Keep Warm, Reheat and Defrost has a cooking hint. If you wish to check, touch Set Up/Help whenever HELP is lighted in the Interactive Display for these and other manual operation hints.

## Control lock

The Control Lock prevents unwanted drawer operation such as by small children. The DrawerMicro Oven can be set so that the control panel and the automatic door mechanism are deactivated or locked.

### TO LOCK

Touch Control Lock pad and hold for 3 seconds. The display shows .

### TO UNLOCK

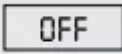
Touch Control Lock pad and hold for 3 seconds. The display shows  . The Control Lock is canceled when the electrical power supply to your oven is interrupted. Set the Control Lock again when power to the oven is restored.

## Setup/Help

If the electrical power supply to your DrawerMicro Oven should be interrupted, the display will intermittently show

**ENJOY YOUR MICRO-WAVE TOUCH CLEAR AND TOUCH CLOCK** after the power is reinstated. If this occurs, the Setup/Help option you input will be erased. Simply touch Stop/Clear pad and reset.

## AUDIBLE SIGNAL ELIMINATION

At the end of timed cook, beeps will sound. The audible signal can be turned off if you prefer quiet operation.

### TO TURN SOUND OFF

1. Touch Setup/Help pad. **TOUCH AGAIN**
2. Touch Setup/Help pad again. **SOUND OFF ? TOUCH START**
3. Touch Start/Add-A-Minute pad. The display shows **SOUND OFF**

### TO RESTORE SOUND

1. Touch Setup/Help pad. **TOUCH AGAIN**
2. Touch Setup/Help pad again. **SOUND ON ? TOUCH START**
3. Touch Start/Add-A-Minute pad. The display shows **SOUND ON**

## END OF COOKING REMINDER

At end of timed cooking, the microwave will signal every 10 seconds for the first minute; then every 3 minutes until Stop/ Clear pad is touched, up to one hour.

### TO TURN REMINDER OFF

1. Touch Setup/Help pad three times. The display shows **REMIND SIGNAL OFF ? TOUCH START**
2. Touch Start/Add-A-Minute pad. The display shows **REMIND SIGNAL OFF**

### TO TURN REMINDER SIGNAL BACK ON

1. Touch Setup/Help pad three times. The display shows **REMIND SIGNAL ON TOUCH START**
2. Touch Start/Add-A-Minute pad. The display shows **REMIND SIGNAL ON**

## AUTO START

If you wish to program the DrawerMicro Oven to begin cooking automatically at a designated time of day, follow this procedure.

1. Touch Setup/Help pad 4 times. The display shows



2. Touch Start/Add-A-Minute pad.

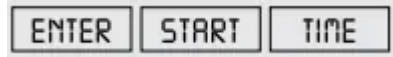

3. Enter start time.

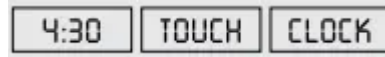

4. Touch Timer/Clock pad.



5. Touch the number keys to enter cooking time.

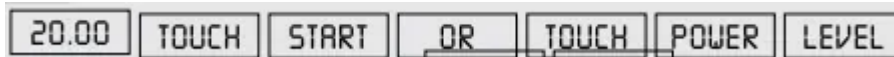

Touch Power Level pad repeatedly until the desired power level is reached.



6. Touch Start/Add-A-Minute pad.

## Timer

1. Touch Timer/Clock pad and number 1.
2. Enter time.
3. Touch Timer/Clock pad again.

To cancel timer, touch Stop/Clear.

## Standby Mode

This microwave will go into standby mode after a period of inactivity. The backlight of the display will automatically dim after 3 minutes if the unit has not been in operation. If the display is in standby mode, simply touch the control panel or open/close the door to return the backlight to maximum brightness.

## Cleaning and Maintenance

Any piece of equipment works better and lasts longer when maintained properly and kept clean. Cooking equipment is no exception. Your DrawerMicro Oven must be kept clean and maintained properly. Disconnect the power cord before cleaning or leave the door open to inactivate the oven during cleaning.

## Exterior

The outside surface is precoated metal and plastic. Clean the outside with mild soap and water; rinse and dry with a soft cloth. Do not use any type of household or abrasive cleaner.

### Stainless Steel Surface

The exterior should be wiped often with a soft damp cloth and polished with a soft dry cloth to maintain its beauty. There are also a variety of products designed especially for cleaning and shining the stainless exterior of the oven. We recommend that the cleaner be applied to a soft cloth and then carefully used on the stainless exterior rather than sprayed directly on to it. Follow package directions carefully.

### Front Side of The Drawer

Wipe the window on both sides with a soft damp cloth to remove any spills or splatters. Metal parts will be easier to maintain if wiped frequently with a soft damp cloth. Avoid the use of spray and other harsh cleaners as they may stain, streak or dull the drawer surface.

### Touch Control Panel

If desired, the touch keys may be deactivated before cleaning. See the Control Lock information on page 21 of this manual. Wipe the panel with a cloth dampened slightly with water only. Dry with a soft cloth. Do not scrub or use any sort of chemical cleaners. Close drawer and follow directions on page 21 for turning Control Lock off. Touch Stop/Clear.

## Interior

Before cleaning the the DrawerMicro Oven, touch and hold the Control Lock button for 3 seconds to lock the control pad and the automatic door mechanism. The drawer can be locked in either the

open or closed position. The display will show . This will prevent the drawer from accidentally opening or closing during cleaning. After cleaning, touch and hold the Control Lock

button for 3 seconds to turn the lock off. The display will show .

Cleaning is easy because no heat is generated to the interior surfaces; therefore, there is no baking and setting of spills or spattering. To clean the interior surfaces, including drawer sealing surfaces, wipe with a soft damp cloth. DO NOT USE ABRASIVE OR HARSH CLEANERS OR SCOURING PADS. For heavier soil, use mild soap; wipe clean with a soft damp cloth. Do not use any chemical oven cleaners.

### Drawer Guides

Remove the food crumbs from the drawer guides. Wipe with a soft dry cloth in order to keep the DrawerMicro Oven opening and closing smoothly.

## **Waveguide Cover**

**ATTENTION** The waveguide cover, located on the inside top of the DrawerMicro Oven area, is made from mica, so it requires special care. Keep the waveguide cover clean to assure good microwave performance. Carefully wipe with a soft damp cloth any food spatters from the surface of the cover immediately after they occur. Built-up splashes may overheat and cause smoke or possibly catch fire. Do not remove the waveguide cover.

## **Odor Removal**

Occasionally, a cooking odor may remain in the DrawerMicro Oven. To remove odor, combine 1 cup water, grated peel and juice of one lemon and several whole cloves in a 2-cup glass microwave-safe measuring cup. Boil for several minutes using 100% power. Leave in the DrawerMicro Oven until water cools. Wipe interior with a soft cloth.

## **Before You Call For Service**

Please check the following before calling for service. It may save you time and expense.

PROBLEM	POSSIBLE CAUSE	SOLUTION
<b>1. Part or all of DrawerMicro Oven does not operate.</b>	<ul style="list-style-type: none"> <li>• Power cord of DrawerMicro Oven is not completely connected to the electrical outlet.</li> <li>• Power outage.</li> <li>• Fuse/circuit breaker at home doesn't work.</li> <li>• DrawerMicro Oven is in Demo Mode.</li> </ul>	<ul style="list-style-type: none"> <li>• Make sure the power cord is tightly connected to the outlet.</li> <li>• Check house lights to be sure. Call your local electric company for service.</li> <li>• Replace the fuse or reset the circuit breaker.</li> <li>• See page 22 for how to cancel Demo Mode.</li> </ul>
<b>2. Food in DrawerMicro Oven is not heated.</b>	<ul style="list-style-type: none"> <li>• No power to the appliance.</li> <li>• DrawerMicro Oven controls improperly set.</li> <li>• DrawerMicro Oven is in Demo Mode.</li> </ul>	<ul style="list-style-type: none"> <li>• See SOLUTION for PROBLEM 1.</li> <li>• Check if the controls have been properly set.</li> <li>• See page 22.</li> </ul>
<b>3. DrawerMicro Oven light does not work</b>	<ul style="list-style-type: none"> <li>• Light bulb is loose or burned out.</li> </ul>	<ul style="list-style-type: none"> <li>• Call for service.</li> </ul>
<b>4. Touch controls will not operate.</b>	<ul style="list-style-type: none"> <li>• Control Lock is on.</li> </ul>	<ul style="list-style-type: none"> <li>• See page 21 to unlock.</li> </ul>
<b>5. Display flashes.</b>	<ul style="list-style-type: none"> <li>• Power failure.</li> </ul>	<ul style="list-style-type: none"> <li>• Touch Clear pad and reset the clock. If the DrawerMicro Oven was in use, you must reset the cooking function.</li> </ul>
<b>6. Steam from the vent.</b>	<ul style="list-style-type: none"> <li>• During microwaving, steam may come from the right side of the vent.</li> </ul>	

### Warning

This content is compiled from multiple sources and is provided for reference purposes only. It may not be complete or fully applicable to all situations. If you are unable to resolve your issue, please contact the product manufacturer or an authorized service provider for official support.



