

Specifications

Power Supply	AC 120V, 60Hz
Rated Power	45W
Effective Range	≤ 219 ft ² / 20 m ²
CADR (CFM)	Smoke: 141, Dust: 140, Pollen: 145
Operating Conditions	Temperature: 14°–104°F / -10°–40°C
	Humidity: < 85% RH
Noise Level	24–50dB
Standby Power	< 0.8W
Dimensions	8.7 x 8.7 x 14.2 in / 22 x 22 x 36 cm
Weight	7.5 lb / 3.4 kg



GETTING TO KNOW YOUR AIR PURIFIER

- A. Fan Speed Indicators
- B. Fan Speed Button
- C. Sleep Mode Indicator/Button
- D. Timer Button
- E. Timer Indicators
- F. On/Off Button
- G. Pet Lock Button
- H. Check Filter Indicator
- I. Display Off Button
- J. Air Outlet
- K. Housing
- L. Air Inlet
- M. Power Cord
- N. Filter Cover
- O. True HEPA 3-Stage Pet Allergy Filter

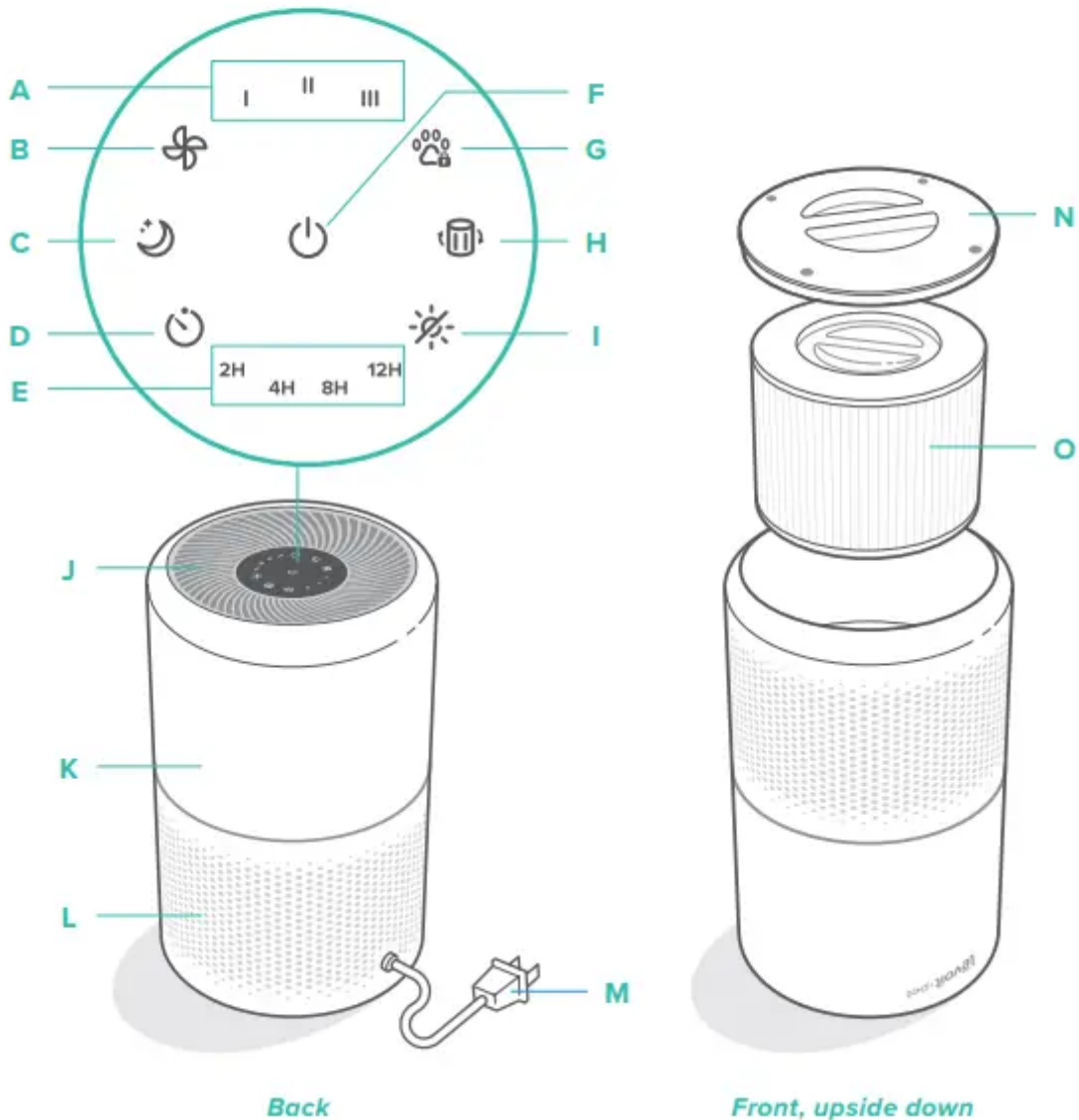

CONTROLS



On/Off Button

- Turns the air purifier on/off.



Fan Speed Button

- Cycles through fan speeds: I (low), II (medium), and III (high).



Sleep Mode Button

- Turns Sleep Mode on/off (see page 8).



Timer Button

- Cycles through timer options (see page 8).



Pet Lock Button

- Prevents current settings from being changed, such as by children or pets (see page 8).



Check Filter Indicator

- Lights up when the air filter should be checked (see [Check Filter Indicator](#) page 10).



Display Off Button

- Turns the display off.
- Tap any button (except ) to turn the display back on.

GETTING STARTED



Figure 1.1

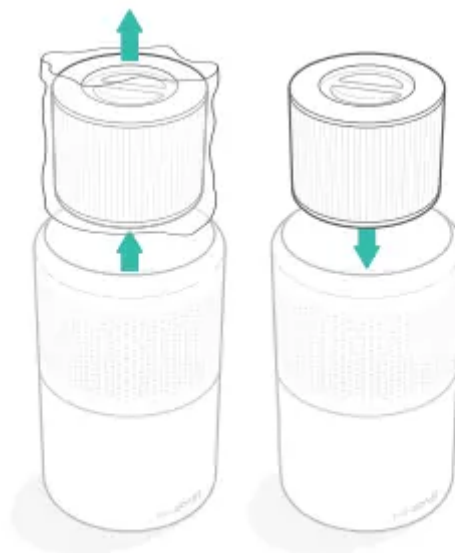

Figure 1.2

1. Flip the air purifier over. Twist the filter cover counterclockwise and remove it. [Figure 1.1]
2. Remove the filter from its plastic packaging and place the filter back into the purifier with the handle facing up. [Figure 1.2]
3. Replace the filter cover and twist clockwise to lock. [Figure 1.3]
4. Place the purifier on a flat, stable surface with the display facing up. Allow at least 15 in / 38 cm of clearance on all sides of the purifier. Keep away from anything that would block air flow, such as curtains. [Figure 1.4]





Figure 1.3



Figure 1.4

USING YOUR PURIFIER

1. Plug in and tap  to turn on the purifier. The fan will start on level I. [Figure 2.1]
2. Optionally, tap  to change fan speed between I, II, and III. Note:
 - The indicators are not buttons and cannot be used to change the fan speed.
 - The fan speed indicators will light up when active.
 - Fan speed III is the loudest, but cleans air the quickest.
 - For best results, or to address a specific air quality issue such as smoke, run the air purifier at maximum speed (level III) for 15–20 minutes before using a lower speed.

- To effectively clean air, keep windows and doors closed while the air purifier is on.



3. Tap to turn off the air purifier.



Figure 2.1

- Memory Function: When the air purifier is plugged in, it will remember its previous fan speed setting. Note: The air purifier will not remember timers or Sleep Mode.

Sleep Mode

- Sleep Mode operates quietly by using the lowest possible fan speed.
- Tap  to turn Sleep Mode on/off.
- Note:
 - All indicators will be at half brightness while Sleep Mode is on.
 - Tapping  will exit Sleep Mode.

Timer

You can set a timer for 2, 4, 8, or 12 hours.

1. Tap  repeatedly to select a time. The timer will start automatically

Note:

- The indicators are not buttons and cannot be used to select a time.
- The timer indicators will light up blue when active

2. Once the timer has finished, the air purifier will power off.

3. To cancel a timer, tap  until all timer indicators are off.

Note:

- You can change the fan speed at any time while the timer is on.
- The timer will restart if the time is changed.

Pet Lock

Locking the display prevents settings from being accidentally changed, such as by children or pets. Buttons will not respond when tapped.

1. Tap and hold  for 3 seconds to lock/ unlock the display.

Note: You can turn the display on and off even if the display is locked.

ABOUT THE PET ALLERGY FILTER

The air purifier uses a 3-stage filtration system to purify air, with special customization for pet allergies and odors.

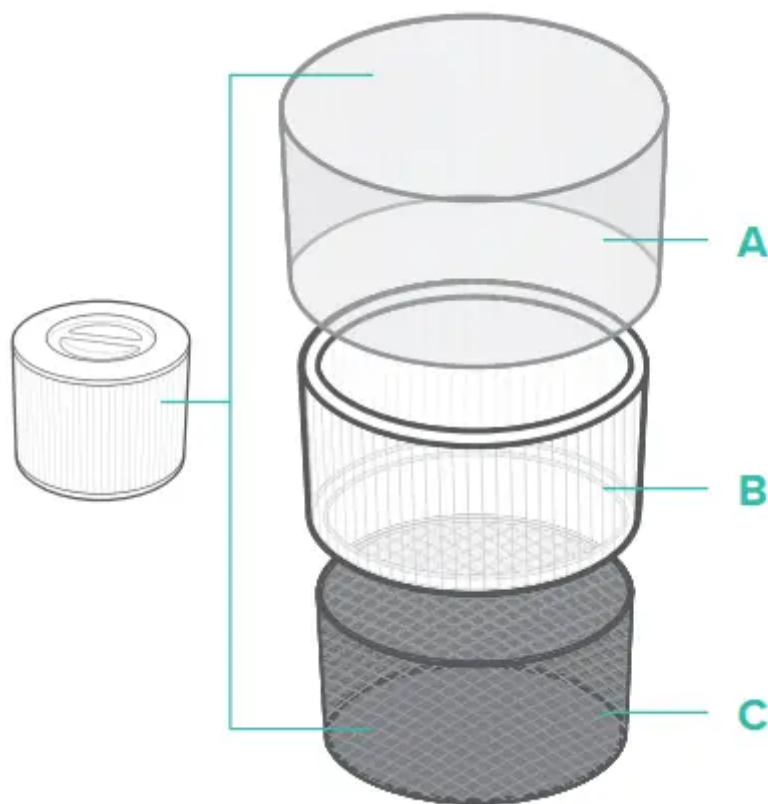

A. Fine Non-Woven Fabric Pre-Filter

- Captures large particles such as dust, lint, fibers, hair, pet fur, and pet dander.
- Maximizes the filter's life.

B. True HEPA Filter

- Removes at least 99.97% of airborne particles 0.3 micrometers (μm) in diameter.
- Filters small particles such as mold spores, tiny dust particles, parts of smoke, and allergens such as pollen, dust mites, and pet dander.

C. Custom High-Efficiency Activated Carbon Filter

- Physically adsorbs unwanted odors and fumes.
- Customized using the ARC formula to be especially effective for cooking smells and pet odors in a multi-pet household.

Clean Air Delivery Rate

- Clean Air Delivery Rate (CADR) measures the efficiency of an air purifier by indicating the volume of clean air that an air purifier produces per minute. This is based on removal of dust, pollen, and smoke, which are the 3 most common indoor air pollutants. The higher the CADR, the more particles the air purifier will remove and the larger the area it can clean. The rating is measured at the air purifier's highest speed.

Air Change per Hour

- The air change rate is how many times all of the air in a room can be purified (or "changed") by the air purifier in 1 hour. Air changes per hour are calculated on the recommended room size assuming 8 ft / 2.4 m ceilings. For smaller rooms, the air change per hour will increase. The Core P350 has an air change per hour of 5, which means it can change air 5 times at the max speed. This purifier is suggested for use in a single, closed room up to 219 ft² / 20 m².
- Note: To effectively clean air, keep windows and doors closed while the air purifier is on.

Humidity

- Moisture may damage the air filters. This air purifier should be used in an area with a humidity level below 85% RH. If you use the air purifier in excessively humid areas, the surface of the filter will become moldy
- Note: Water or moisture will allow mold to grow. Air purifiers cannot solve an existing mold problem, only remove mold spores and reduce odors.

Essential Oils

- Do not add essential oils to the air purifier or air filter. The filter will become damaged by the oil and will eventually release an unpleasant smell. Do not use oil diffusers near the purifier.



KEEPING THINGS CLEAN

Cleaning the Air Purifier



- Unplug before cleaning.

- Wipe the outside of the air purifier with a soft, dry cloth. If necessary, wipe the housing with a damp cloth, then immediately dry.
- Vacuum the inside of the air purifier.
- Do not clean with abrasive chemicals or flammable cleaning agents.

When Should I Replace the Air Filter?

- The filter should be replaced every 6–8 months. You may need to replace your filter sooner or later depending on how often you use your air purifier. Using your air purifier in an environment with relatively high pollution may mean you will need to replace the filter more often, even if  is off.
- You may need to replace your filter if you notice:
 - Increased noise when the air purifier is on
 - Decreased airflow
 - Unusual odors
 - A visibly clogged filter
- Note:
 - To maintain the performance of your air purifier, only use official Levoit filters. To buy replacement filters, visit Levoit's online store. Go to levoit.com for more information.
 - Remember to reset  after changing the filter.

Check Filter Indicator

-  will light up as a reminder to check the air filter. Depending on how much you use the air purifier, the indicator should turn on within 6–8 months. You may not need to replace your filter yet, but you should check it when  turns on.

Cleaning the Air Filter

- The outer pre-filter should be cleaned every 2–4 weeks to increase the efficiency and extend the life of your filter. Clean the pre-filter using a soft brush or vacuum hose to remove hair, dust, and large particles. [Figure 3.1] Do not clean the filter with water or other liquids.







Filter	When to Clean	When to Replace
Pre-Filter	Every 2–4 weeks	6–8 months
True HEPA & Activated Carbon Filter	Do not clean	





Figure 3.1

Resetting the Check Filter Indicator

Reset the Check Filter Indicator when:

- A.  lights up.
 1. Replace the air filter.
 2. Turn on the air purifier.
 3. Press and hold  for 3 seconds.
 4.  will turn off when successfully reset.
- B. The air filter was changed before  lit up.
 1. Press and hold  for 3 seconds. This will turn on .

2. Press and hold  again for 3 seconds.
3.  will turn off when successfully reset.

Replacing the Air Filter



Figure 3.2

1. Unplug the air purifier. Flip the air purifier over and remove the filter cover (see Getting Started).
2. Remove the old air filter.
3. Clean out any remaining dust or hair inside the purifier using a vacuum hose. Do not use water or liquids to clean the purifier. [Figure 3.2]
4. Unwrap the new air filter and place it into the housing (see Getting Started)
5. Replace the cover and cap. Plug in the air purifier.
6. Reset the Check Filter Indicator.

Storage

- If not using the air purifier for an extended period of time, wrap both the purifier and the filter in plastic packaging and store in a dry place to avoid moisture damage.

TROUBLESHOOTING

1. Air purifier will not turn on or respond to button controls.

- Plug in the air purifier.
- Check to see if the power cord is damaged. If so, stop using the air purifier and contact Customer Support
- Plug the air purifier into a different outlet.
- The air purifier is malfunctioning. Contact Customer Support

2. Airflow is significantly reduced.

- Make sure the filter is removed from its packaging and properly in place
- Tap  to increase the fan speed.
- Make sure there are at least 15 in / 38 cm of clearance on all sides of the air purifier.
- The pre-filter may be clogged by large particles, such as hair or lint, blocking air flow. Clean the pre-filter.
- Replace the air filter

3. Air purifier makes an unusual noise while the fan is on.

- Make sure the air filter is properly in place with plastic packaging removed
- Make sure the air purifier is operating on a hard, flat, even surface.
- Replace the air filter
- The air purifier may be damaged, or a foreign object may be inside. Stop using the air purifier and contact Customer Support. Do not try to repair the air purifier.

4. Strange smell coming from the purifier.

- Clean the filter or replace if necessary.
- Contact Customer Support
- Make sure not to use your purifier in an area with high humidity or while diffusing essential oils.

5. Poor air purification quality.



- Tap  to increase the fan speed.
- Make sure no objects are blocking the sides or top of the air purifier (the inlet or outlet).
- Make sure the filter is removed from its packaging and properly in place
- Close doors and windows while using the air purifier.
- Make sure the room is smaller than 219 ft² / 20 m². The air purifier may not be as effective in larger rooms.

- Replace the filter



6.  is still on after replacing the air filter.

- Reset the Check Filter Indicator .

7.  has not turned on within 8 months.

-  is a reminder for you to check the air filter and will light up based on how long the air purifier has been used. If you don't use your air purifier often,  will take longer to turn on.

8.  turned on before 6 months.

-  is a reminder for you to check the air filter and will light up based on how long the air purifier has been used. If you run your air purifier frequently,  will turn on sooner

SAFETY INFORMATION

To reduce the risk of fire, electric shock, or other injury, follow all instructions and safety guidelines.

- Only use your air purifier as described in this manual.
- Do not use without removing the plastic wrap from the filter. The purifier will not filter air, and may overheat, causing a fire hazard.
- Do not use your air purifier outdoors.
- Keep your air purifier away from water, and wet or damp areas. Never place in water or liquid.
- Do not use in excessively humid areas.
- Keep your air purifier away from heat sources.
- Do not use where combustible gases, vapors, metallic dust, aerosol (spray) products, or fumes from industrial oil are present.
- Keep 5 ft / 1.5 m away from where oxygen is being administered.
- Supervise children when they are near the air purifier.
- Do not place anything into any opening on the air purifier.
- Do not sit or place heavy objects on the air purifier.
- Keep the inside of the air purifier dry. To prevent moisture buildup, avoid placing in rooms with major temperature changes or underneath air conditioners.
- Always unplug your air purifier before servicing (such as changing the air filter)
- Do not use your air purifier if it is damaged or not working correctly, or if the cord or plug is damaged. Do not try to repair it yourself. Contact Customer Support

- **WARNING:** Do not use this air purifier with solid-state speed controls (such as a dimmer switch).
- Not for commercial use. Household use only

Power and Cord

- Keep air purifier near the outlet it is plugged into.
- Never place the cord near any heat source.
- Do not cover the cord with a rug, carpet, or other covering. Do not place the cord under furniture or appliances.
- Keep the cord out of areas where people walk often. Place the cord where it will not be tripped over.
- Your air purifier has a polarized plug (one prong is wider than the other), which fits into a polarized outlet only one way. This is a safety feature to reduce the risk of electric shock. If the plug does not fit, reverse the plug. If it still does not fit, do not use the plug in that outlet. Do not bypass this safety feature.
- This air purifier uses standard US 120V, 60Hz outlets. If using in a different area, check for compatibility

Warning

This content is compiled from multiple sources and is provided for reference purposes only. It may not be complete or fully applicable to all situations. If you are unable to resolve your issue, please contact the product manufacturer or an authorized service provider for official support.