

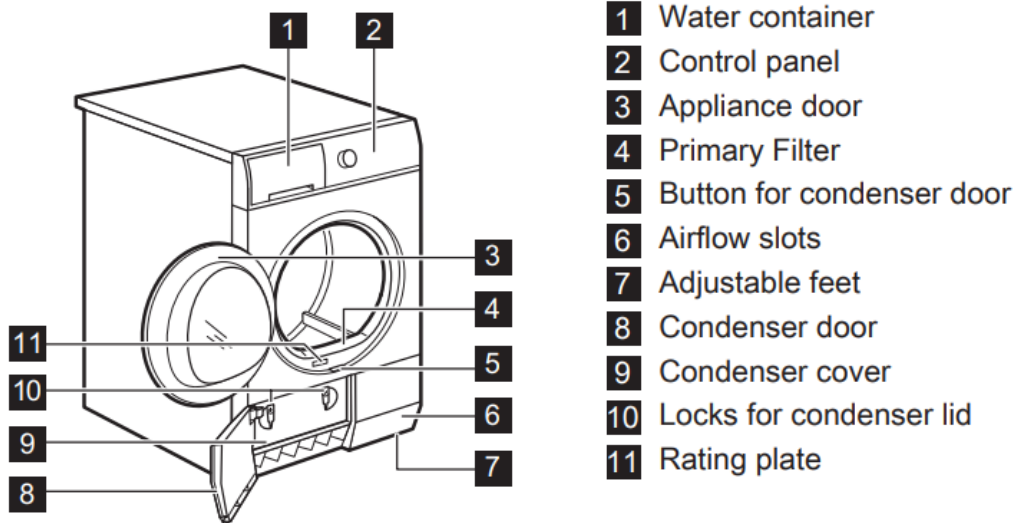

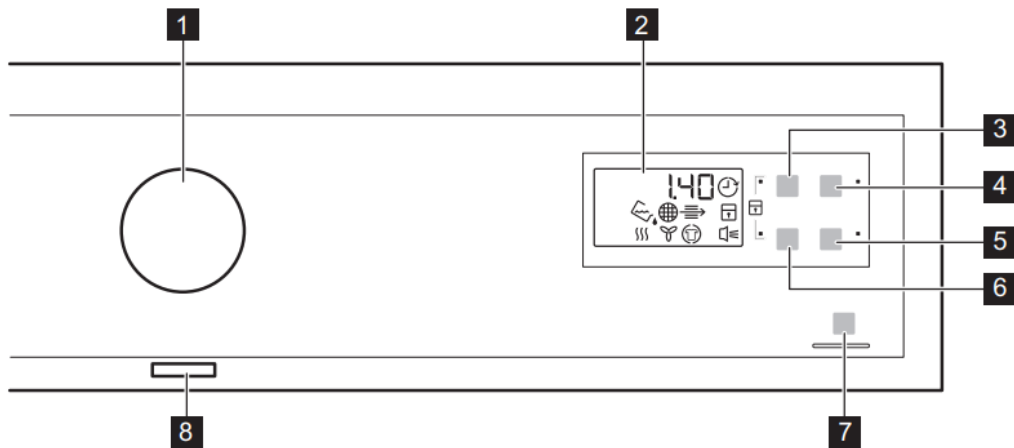

PRODUCT DESCRIPTION





- The load door can be installed by the user in the opposite side. It can help to easily put and remove the laundry or if there is a limit to install the appliance (see separate leaflet)

CONTROL PANEL











- 1** Programme knob
- 2** Display
- 3**  Time touchpad
- 4**  Delay touchpad
- 5**  Delicate touchpad











- 6**  Wool Load touchpad
- 7**  Start/Pause touchpad
- 8** On/Off button























- Touch the touchpads with your finger in the area with the symbol or name of the option. Do not wear gloves when you operate with the control panel. Make sure that the control panel is always clean and dry.

Indicators

Indicators	Description
	Drying phase
	Cooling phase
	Crease guard phase
	Condenser
	Water container
	Filter
	Delay start
	Child lock
	Acoustic signals
2 . 0 0	Programme duration
1 0 ' - 2 . 0 0	Time Drying duration
3 0 ' - 2 0 h	Delay start duration

PROGRAMME TABLE

Programmes	Type of load	Load (max.) ¹⁾ / Fabric mark
 Cotton		
 Extra Dry	Drying level: extra dry.	8kg/  
 Strong Dry ²⁾	Drying level: strong dry.	8kg/  
 Cupboard Dry	Drying level: cupboard dry.	8kg/  

 Iron Dry	Drying level: applicable for iron.	8kg/ 
 Synthetic		
 Extra Dry	Drying level: extra dry.	3,5kg/ 
 Cupboard Dry	Drying level: cupboard dry.	3,5kg/ 
 Iron Dry	Drying level: applicable for iron.	3,5kg/ 
 Easy Iron	Easy care fabrics for which a minimum of ironing is necessary. The drying results can be different from one type of fabric to the other. Shake the items before you put them in the appliance. When the programme is completed, Immediately remove the items and put them on a hanger.	1kg (or 5 shirts)/ 
 Duvets	To dry one or two duvet and pillows (with feather, down or synthetic fillings).	3kg/ 
 Delicates	Delicate fabrics.	2kg/ 
 Wool ³⁾	Wool fabrics. Gentle drying washable woollens. Remove immediately the items when the programme is completed.  WOOLMARK APPAREL CARE	1kg
	For drying sports shoes only with Drying Rack (available as additional accessory from www.electrolux.com.au/shop)	1 pair of sport shoes
 Refresh	Refreshing a textiles that were in storage.	1kg
 Time Drying	With this programme you can use the option Time and set the programme duration.	8kg/ 
 Quick	To dry cotton and synthetic fabrics, uses low temperature.	2kg/ 

1) The maximum weight refers to dry items.

2) For test institutes only: Standard program for tests are specified in the AS/NZS 2442.2 document.

3) The wool drying cycle of this machine has been approved by The Woolmark Company for the drying of machine washable wool products provided that the products are washed and dried according to the instructions on the garment label and those issued by the manufacturer of this

machine. M1221. In UK, Eire, Hong Kong and India the Woolmark symbol is a certification trademark.

OPTIONS

Time

This option is applicable to the Time Drying programme and to the Wool programme (only with the Drying Rack)..

We recommend that you set a short duration for small quantities of laundry or for only one item.

- **Time Drying programme:** You can set the programme duration, from a minimum of 10 minutes to a maximum of 2 hours. The setting of the duration is related to the quantity of laundry in the appliance.
- **Wool programme:** You can set the programme duration, from a minimum of 30 minutes to a maximum of 4 hours. The setting of the duration is related to the quantity of laundry in the appliance.

Wool Load









This option is applicable only to the Wool programme. To get laundry more dried press the Wool















Load  touchpad again and again to increase the programme duration.

Delicate

With this option you can set a delicate drying programme that has a low temperature. Use this option with a fabrics that have the symbol  on the fabric label (e.g. acrylic, viscose).

Options table

Programmes ¹⁾			
 Cotton			
 Extra Dry			■
 Strong Dry			■
 Cupboard Dry			■
 Iron Dry			■





Programmes ¹⁾			
 Synthetic			
 Extra Dry			■
 Cupboard Dry			■
 Iron Dry			■
 Easy Iron			■
 Duvets			■
 Delicates			■
 Wool	■ 2)	■	■
 Refresh			
 Time Drying	■		■
 Quick			

1) Together with the programme you can set 1 or more options. To activate or deactivate them, press the related touchpad.

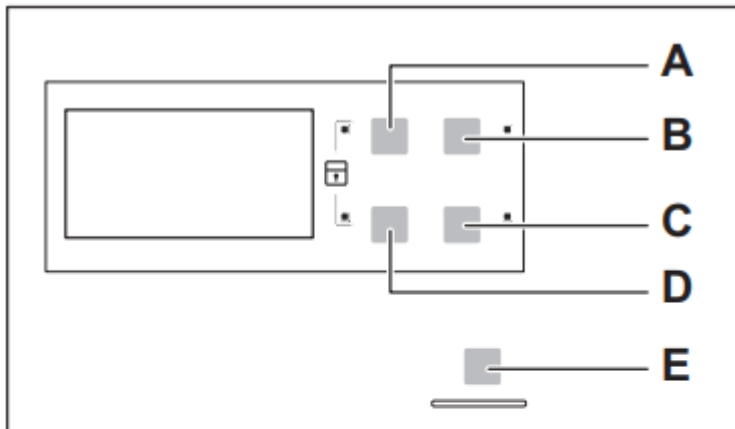
2) Only with the Drying Rack (standard accessory or optional, depending on model).

SETTINGS



- A) Time  touchpad
- B) Delay  touchpad
- C) Delicate  touchpad
- D) Wool Load  touchpad
- E) Start/Pause  touchpad

Child lock function

This option prevents children to play with the appliance while a programme operates. The programme knob and the touchpads are locked. Only the on/off button is unlocked.

Activating the child lock option:

1. Press the on/off button to activate the appliance.
2. Wait approximately 8 seconds.
3. Press and hold touchpads (A) and (D) at the same time. The child lock indicator comes on.

The child lock indicator comes on.

- It is possible to deactivate the child lock option while a programme operates. Press and hold the same touchpads until the child lock indicator goes off.

Buzzer on/off



To deactivate or activate the acoustic signals, press and hold for approximately 2 seconds touchpads (B) and (C) at the same time.

Adjustment of the remaining laundry moisture degree

To change the default degree of the remaining moisture of the laundry:

1. Press the on/off button to activate the appliance.
2. Wait approximately 8 seconds.
3. Press and hold buttons **(A)** and **(B)** at the same time.

One of the these indicators comes on:

-  the maximum dry laundry
-  the more dry laundry
-  the standard dry laundry

4. Press the button **(E)** again and again until the indicator of the correct level comes on.
5. To confirm the adjustment, press and hold buttons **(A)** and **(B)** at the same time for approximately 2 seconds.

DAILY USE

Start a programme without delay start

1. Prepare the laundry and load the appliance.
2. Press the on/off button to activate the appliance.
3. Set the correct programme and options for the type of load. The display shows the programme duration.
4. Press the Start/Pause touchpad. The programme starts.

The drying time you see is related to the load of 5 kg for cotton and jeans programmes. For the other programmes the drying time is related to the recommended loads. The drying time of the cotton and jeans programmes with the load more than 5 kg is longer.

Starting the programme with delay start

1. Set the correct programme and options for the type of load.
2. Press the delay start button again and again until the display shows the delay time you want to set.
3. Press the Start/Pause touchpad.

The display shows the countdown of the delay start.

When the countdown is completed, the programme starts.



You can delay the start of a programme from a minimum of 30 minutes to a maximum of 20 hours.

Change a programme

1. Press the on/off button to deactivate appliance
2. Press the on/off button to activate the appliance.
3. Set the programme.

At the end of the programme

When the programme is completed:



- An intermittent acoustic signal operates.
- The indicator  flashes.
- The indicator  flashes.
- The Start/Pause indicator is on.

The appliance continues to operate with the crease guard phase for approximately other 30 minutes.

The crease guard phase removes creases from your laundry.

You can remove the laundry before the crease guard phase is completed. We recommend, for better results, that you remove the laundry when the phase is almost completed or completed.

When the crease guard phase is completed:

- The indicator  is on but does not flash.
 - The indicator  is on but does not flash.
 - Start/Pause indicator goes off.
1. Press the on/off button to deactivate the appliance.
 2. Open the appliance door.
 3. Remove the laundry.
 4. Close the appliance door.
- Always clean the filter and empty the water container when a programme is completed.

Stand-by function





To decrease the energy consumption, this function automatically deactivates the appliance:

- After 5 minutes if you do not start the programme.
- After 5 minutes from the end of the programme.

HINTS AND TIPS

Preparing the laundry

- Close the zippers.
- Close the fasteners of the duvet covers.
- Do not keep ties or ribbons loose (e.g. apron ribbons). Tie them before you start a programme.
- Remove all items from the pockets.
- If an item has the internal layer made of cotton, turn it inside out. Make sure that the cotton layer is always external
- We recommend that you set the correct programme applicable for the type of fabrics that are in the appliance.
- Do not put fabrics with strong colours together with fabrics with light colours. Strong colours can bleed.
- Use an applicable programme for cotton jersey and knitwear to prevent the items to shrink.
- Make sure that the laundry weight is not more than the maximum weight that is in the programme table.
- Dry only the laundry that is applicable for tumble dryer. Refer to the fabric label on the items.

Fabric label	Description
	Laundry that is applicable for tumble drying.
	Laundry that is applicable for tumble drying and resists higher drying temperature.
	Laundry that is applicable for tumble drying but only with low drying temperature.
	Laundry that is not applicable for tumble drying.

CARE AND CLEANING

Cleaning the filter

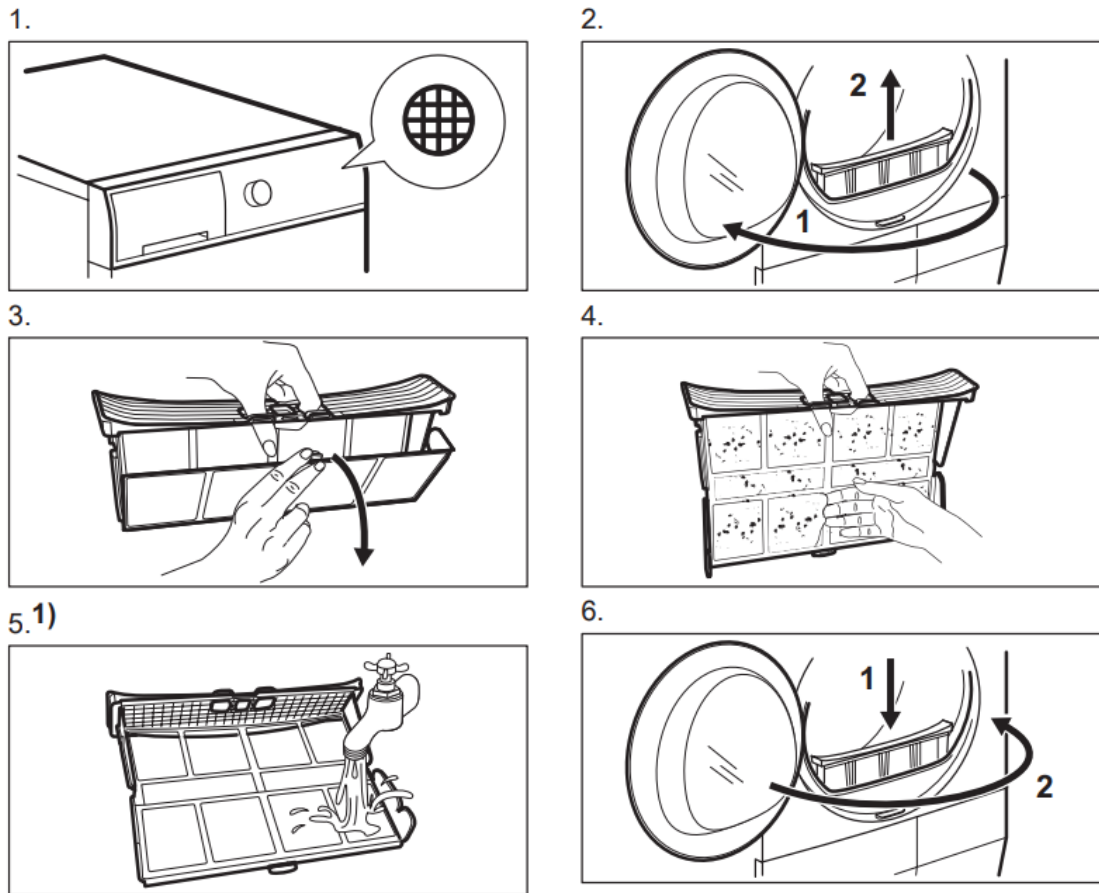

1) if necessary, clean the filter with hot water.

Draining the water container

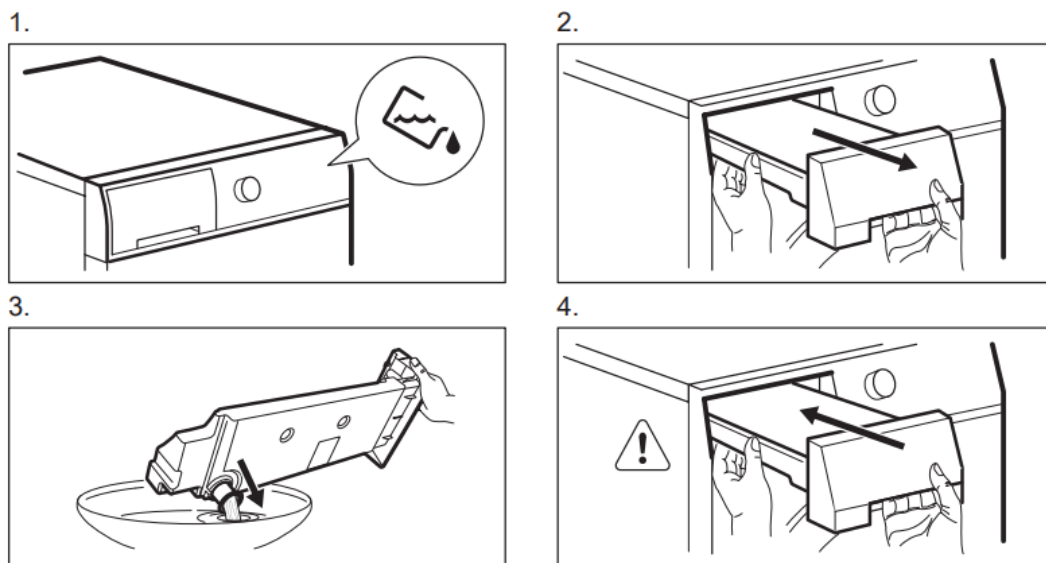

You can use the water from the water container as an alternative to distilled water (e.g. for steam ironing). Before you use the water, remove dirt residues with a filter.

Cleaning the condenser

1.

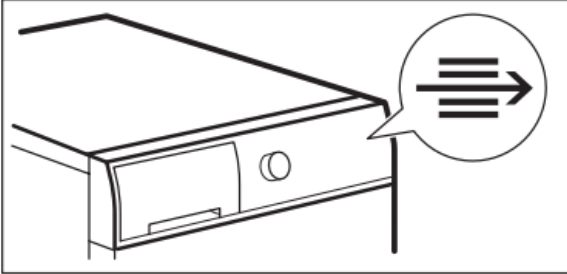

2.

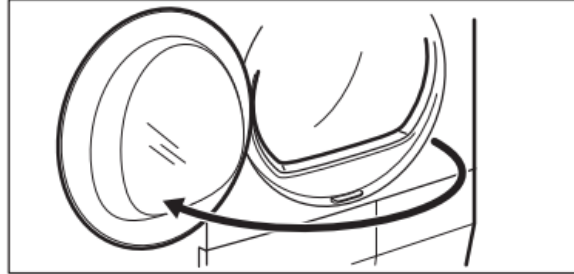

3.

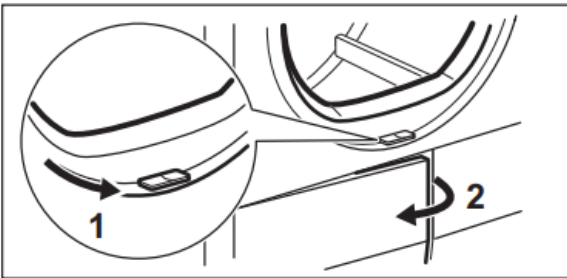

4.

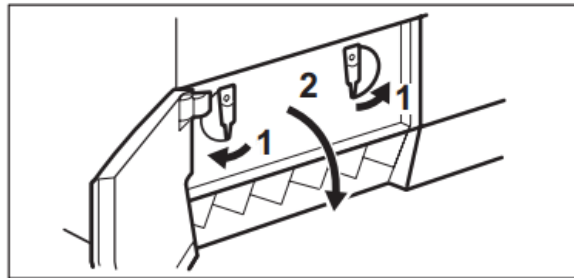

5.

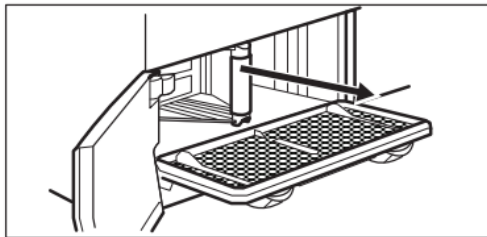

6.



7.

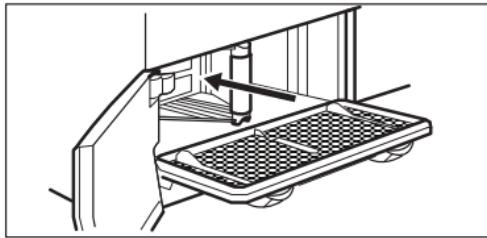

8.

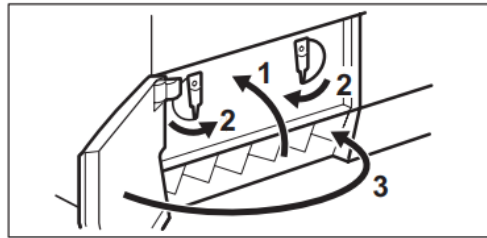

Cleaning the drum

Use a standard neutral soap detergent to clean the inner surface of the drum and drum ribs. Dry the cleaned surfaces with a soft cloth.

Cleaning the control panel and housing

Use a standard neutral soap detergent to clean the control panel and housing.

Use a moist cloth to clean. Dry the cleaned surfaces with a soft cloth.



Cleaning the airflow slots

Use a vacuum cleaner to remove the fluff from the airflow slots.

TROUBLESHOOTING

Problem	Possible solution
You cannot activate the appliance.	Make sure that the mains plug is connected to the mains socket.
	Check fuse in fuse box (domestic installation).
The programme does not start.	Press Start/Pause.
	Make sure that the appliance door is closed.

The appliance door does not close.	Make sure that the installation of the filter is correct.
	Make sure that the laundry does not catch between the appliance door and the rubber seal.
The appliance stops during operation.	Make sure that the water container is empty. Press Start/ Pause to start the programme again.
The display shows a long programme duration. 1)	Make sure that the weight of the laundry is applicable to the duration of the programme.
	Make sure that the filter is clean.
	The laundry is too wet. Spin the laundry in the washing machine again.
	Make sure that the room temperature is not too warm.
The display shows a short programme duration.	Set the Time Drying or the Extra Dry programme.
The display shows Err .	If you want to set a new programme, deactivate and activate the appliance.
	Make sure that the options are applicable to the programme.
The display shows (e.g. E51).	Deactivate and activate the appliance. Start a new programme. If the problem occurs again, contact the Service.
1) After maximum 5 hours, the programme ends automatically	

If the drying results are not satisfactory

- The set programme was incorrect.
- The filter is clogged.
- The condenser is clogged.
- There was too much laundry in the appliance.
- The drum is dirty.
- Incorrect setting of the conductivity sensor.

- The airflow slots are clogged.

Warning

This content is compiled from multiple sources and is provided for reference purposes only. It may not be complete or fully applicable to all situations. If you are unable to resolve your issue, please contact the product manufacturer or an authorized service provider for official support.

Document generated by [ManualsFile](#)

