

Operating Instructions

Features of Your Microwave

(Throughout this manual, features and appearance may vary from your model.)

Features

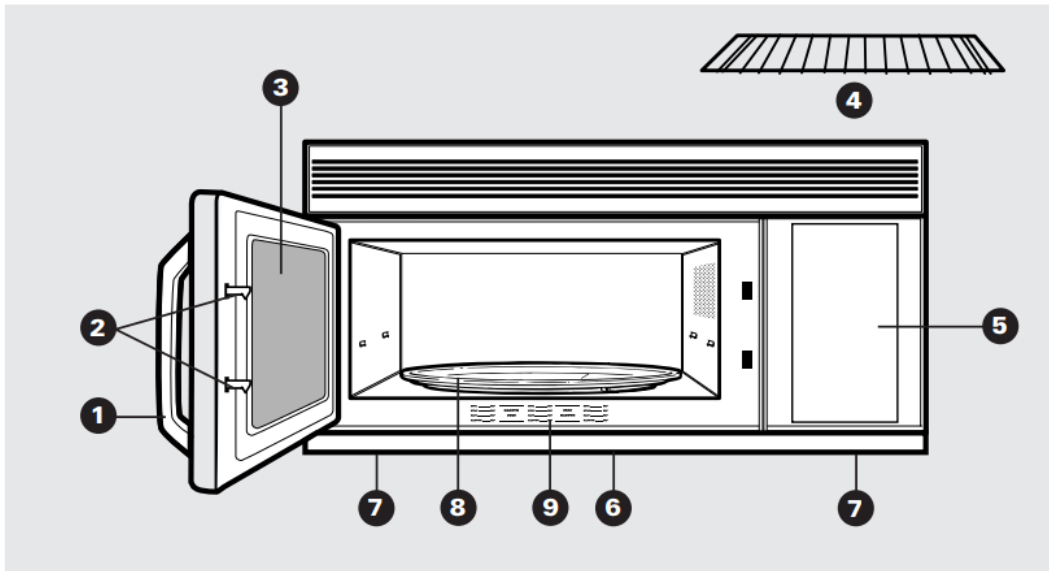

1. Door Handle. Pull to open the door. The door must be securely latched for the microwave to operate.

2. Door Latches.

3. Window with Metal Shield. Screen allows cooking to be viewed while keeping microwaves confined in the oven.

4. Shelf (if included). Lets you microwave several foods at once. Food microwaves best when placed directly on the oven floor or turntable.

5. Touch Control Panel

You must set the clock before using the microwave.

6. Cooktop Lights.

7. Grease Filters

8. Removable Turntable.

Turntable and support must be in place when using the oven. The turntable may be removed for cleaning.

9. Convenience Guide.

NOTE: Rating plate, oven vent(s) and oven light are located on the inside walls of the microwave oven.

Quick Start

The Controls on Your Microwave Oven

(Throughout this manual, features and appearance may vary from your model.)

You can microwave by time or with the convenience features.

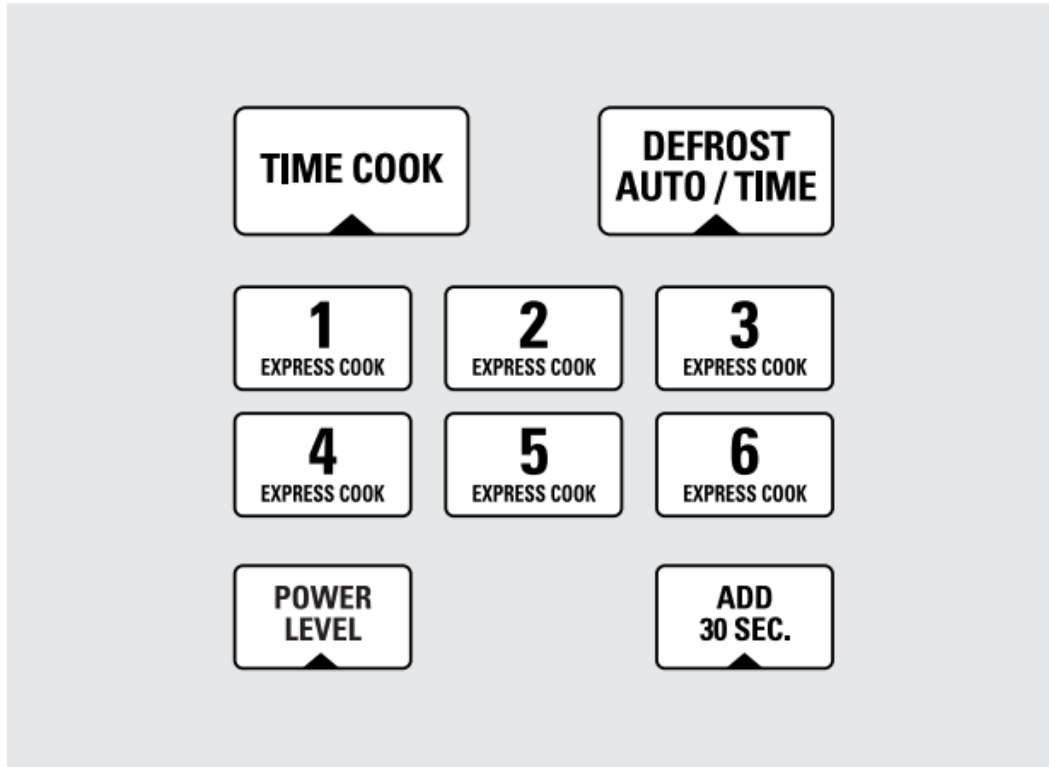

1. Time Features

Time Cooking

<i>Press</i>	<i>Enter</i>
TIME COOK I & II (Press once or twice)	Amount of cooking time.
DEFROST AUTO/TIME (Press twice)	Amount of defrosting time.
EXPRESS COOK	Starts immediately!
POWER LEVEL	Power level 1–10.
ADD 30 SEC	Starts immediately!

HELP (on some models): Press this pad and any feature pad for usage instructions and tips.

GUIDE ON MICROWAVE: Before you begin, check the guide located on the inside front of the oven when you open the door.

GUIDES IN BOOK

- Cooking
- Time Defrost
- Reheat
- Snacks

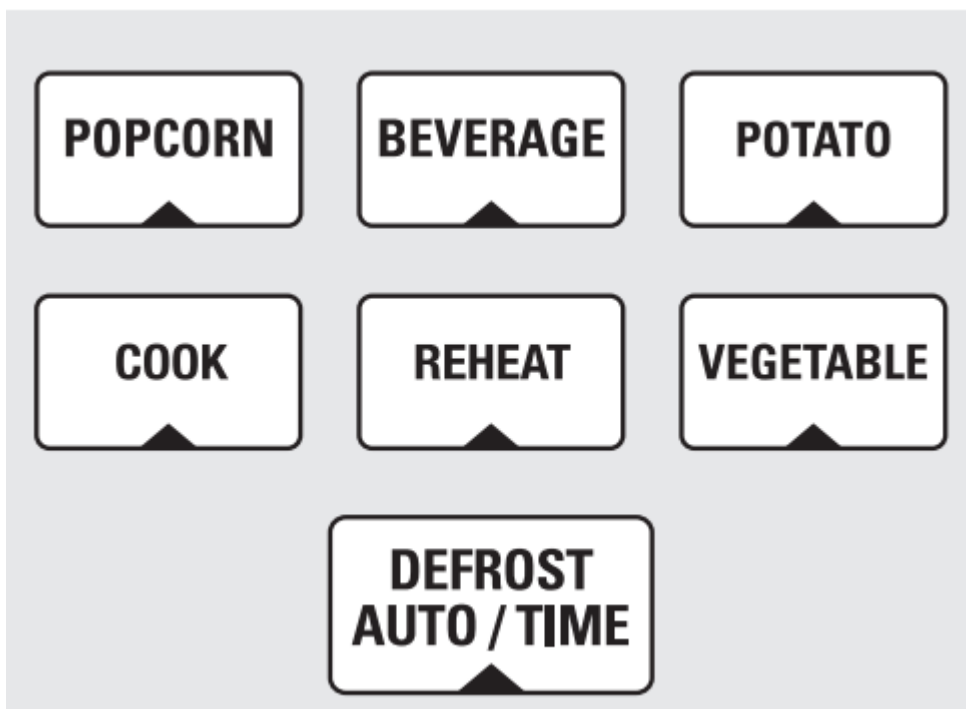

2. Convenience Features



Press	Enter	Option
POPCORN Press once Press twice	Starts immediately! 3.5 oz. 3.0 oz.	more/less time
BEVERAGE	Starts immediately!	1–3 servings
COOK (on some models)	Food type 1–9 + weight	
REHEAT (See Reheat Guide)	Food type 1–6	1–3 servings
POTATO	Starts immediately!	1–4 potatoes
VEGETABLE	Starts immediately!	food type/serving size
DEFROST AUTO/TIME (Press once)	Food weight	

Changing Power Levels



How to Change the Power Level

The power level may be entered or changed immediately after entering the feature time for TIME COOK, TIME DEFROST or EXPRESS COOK. The power level may also be changed during time countdown.

1. **Press TIME COOK or select Time Defrost.**
2. **Enter cooking or defrosting time.**
3. **Press POWER LEVEL.**
4. **Select desired power level 1–10.**
5. **Press START**

Variable power levels add flexibility to microwave cooking. The power levels on the microwave oven can be compared to the surface units on a range. High (power level 10) or full power is the fastest way to cook and gives you 100% power. Each power level gives you microwave energy a certain percent of the time. Power level 7 is microwave energy 70% of the time. Power level 3 is energy 30% of the time.

A high setting (10) will cook faster but food may need more frequent stirring, rotating or turning over. Most cooking will be done on High (power level 10). A lower setting will cook more evenly and need less stirring or rotating of the food.

Some foods may have better flavor, texture or appearance if one of the lower settings is used. Use a lower power level when cooking foods that have a tendency to boil over, such as scalloped potatoes.

Rest periods (when the microwave energy cycles off) give time for the food to “equalize” or transfer heat to the inside of the food. An example of this is shown with power level 3—the defrost cycle. If micro-wave energy did not cycle off, the outside of the food would cook before the inside was defrosted.

Here are some examples of uses for various power levels:

Power Level	Best Uses
High 10	Fish, bacon, vegetables, boiling liquids.
Med-High 7	Gentle cooking of meat and poultry; baking casseroles and reheating.
Medium 5	Slow cooking and tenderizing such as stews and less tender cuts of meat.
Low 2 or 3	Defrosting without cooking; simmering; delicate sauces
Warm 1	Keeping food warm without overcooking; softening butter



Time Features

Time Cook



1. Press **TIME COOK**.
2. Enter cooking time.
3. Change power level if you don't want full power. (Press **POWER LEVEL**. Select a desired power level 1–10.)
4. Press **START**

Time Cook I

Allows you to microwave for any time up to 99 minutes and 99 seconds.

Power level 10 (High) is automatically set, but you may change it for more flexibility.

You may open the door during Time Cook to check the food. Close the door and press **START** to resume cooking

Time Cook II

Lets you change power levels automatically during cooking. Here's how to do it:

1. Press **TIME COOK**.
2. Enter the first cook time.
3. Change the power level if you don't want full power. (Press **POWER LEVEL**. Select a desired power level 1–10.)
4. Press **TIME COOK** again.

5. Enter the second cook time.
6. Change the power level if you don't want full power. (Press POWER LEVEL. Select a power level 1–10.)
7. Press START.

At the end of Time Cook I, Time Cook II counts down.

Cooking Guide for Time Cook I & II

NOTE: Use power level High (10) unless otherwise noted.



Vegetable	Amount	Time	Comments
Asparagus (fresh spears) (frozen spears)	1 lb. 10-oz. package	6 to 9 min., Med-High (7) 5 to 7 min.	In 1 1/2-qt. oblong glass baking dish, place 1/4 cup water. In 1-qt. casserole.
Beans (fresh green) (frozen green) (frozen lima)	1 lb. cut in half 10-oz. package 10-oz. package	9 to 11 min. 6 to 8 min. 6 to 8 min.	In 1 1/2-qt. casserole, place 1/2 cup water. In 1-qt. casserole, place 2 tablespoons water. In 1-qt. casserole, place 1/4 cup water.
Beets (fresh, whole)	1 bunch	17 to 21 min	In 2-qt. casserole, place 1/2 cup water.
Broccoli (fresh cut) (fresh spears) (frozen, chopped) (frozen spears)	1 bunch (1 1/4 to 1 1/2 lbs.) 1 bunch (1 1/4 to 1 1/2 lbs.) 10-oz. package 10-oz. package	7 to 10 min 9 to 13 min 5 to 7 min. 5 to 7 min.	In 2-qt. casserole, place 1/2 cup water In 2-qt. oblong glass baking dish, place 1/4 cup water. In 1-qt. casserole. In 1-qt. casserole, place 3 tablespoons water
Cabbage (fresh) (wedges)	1 medium head (about 2 lbs.)	8 to 11 min. 7 to 10 min.	In 1 1/2- or 2-qt. casserole, place 1/4 cup water. In 2- or 3-qt. casserole, place 1/4 cup water

<p>Carrots (fresh, sliced) (frozen)</p>	<p>1 lb 10-oz. package</p>	<p>7 to 9 min 5 to 7 min.</p>	<p>In 1 1/2-qt. casserole, place 1/4 cup water In 1-qt. casserole, place 2 tablespoons water</p>
<p>Cauliflower (flowerets) (fresh, whole) (frozen)</p>	<p>1 medium head 1 medium head 10-oz. package</p>	<p>9 to 14 min. 10 to 17 min 5 to 7 min.</p>	<p>In 2-qt. casserole, place 1/2 cup water In 2-qt. casserole, place 1/2 cup water. In 1-qt. casserole, place 2 tablespoons water.</p>
<p>Corn (frozen kernel)</p>	<p>10-oz. package</p>	<p>5 to 7 min.</p>	<p>In 1-qt. casserole, place 2 tablespoons water.</p>
<p>Corn on the cob (fresh) (frozen)</p>	<p>1 to 5 ears 1 ear 2 to 6 ears</p>	<p>3 to 4 min per ear 5 to 6 min. 3 to 4 min. per ear</p>	<p>In 2-qt. oblong glass baking dish, place corn. If corn is in husk, use no water; if corn has been husked, add 1/4 cup water. Rearrange after half of time. Place in 2-qt. oblong glass baking dish. Cover with vented plastic wrap. Rearrange after half of time.</p>
<p>Mixed vegetables (frozen)</p>	<p>10-oz. package</p>	<p>5 to 7 min</p>	<p>In 1-qt. casserole, place 3 tablespoons water.</p>
<p>Peas</p>	<p>2 lbs. unshelled</p>	<p>9 to 12 min</p>	<p>In 1-qt. casserole, place 1/4 cup water</p>

(fresh, shelled) (frozen)	10-oz. package	5 to 7 min	In 1-qt. casserole, place 2 tablespoons water.
Potatoes (fresh, cubed, white) (fresh, whole, sweet or white)	4 potatoes (6 to 8 oz. each) 1 (6 to 8 oz.)	9 to 12 min 3 to 4 min.	Peel and cut into 1 inch cubes. Place in 2-qt. casserole with 1/2 cup water. Stir after half of time. Pierce with cooking fork. Place in center of the oven. Let stand 5 minutes.
Spinach (fresh) (frozen, chopped and leaf)	10 to 16 oz. 10-oz. package	5 to 7 min. 5 to 7 min.	In 2-qt. casserole, place washed spinach. In 1-qt. casserole, place 3 tablespoons water.
Squash (fresh, summer and yellow) (winter, acorn butternut)	1 lb. sliced 1 to 2 squash (about 1 lb. each)	5 to 7 min. 8 to 11 min.	In 1 1/2-qt. casserole, place 1/4 cup water. Cut in half and remove fibrous membranes. In 2-qt. oblong glass baking dish, place squash cut-side down. Turn cut-side-up after 4 minutes.

Time Defrost



1. **Press DEFROST AUTO/TIME twice.**
2. **Enter defrosting time.**
3. **Press START.**
4. **Turn food over when the oven signals.**
5. **Press START.**

(Auto Defrost explained in the section on Convenience Features.)

Allows you to defrost for the length of time you select. See the Defrosting Guide for suggested times.

Power level 3 is automatically set, but you may change this for more flexibility. You may defrost small items more quickly by raising the power level after entering the time. However, they will need more frequent attention than usual.

Power level 7 cuts the total defrosting time in about half; power level 10 cuts the total time to approximately 1/3. Rotate or stir food frequently.

At one half of selected defrosting time, the oven signals TURN. At this time, turn food over and break apart or rearrange pieces for more even defrosting. Shield any warm areas with small pieces of foil.

A dull thumping noise may be heard during defrosting. This sound is normal when the oven is not operating at High power.

Defrosting Tips

- Foods frozen in paper or plastic can be defrosted in the package. Tightly closed packages should be slit, pierced or vented **AFTER** food has partially defrosted. Plastic storage containers should be at least partially uncovered.
- Family-size, prepackaged frozen dinners can be defrosted and microwaved. If the food is in a foil container, transfer it to a microwave-safe dish.
- Foods that spoil easily, such as milk, eggs, fish, stuffings, poultry and pork, should not be allowed to sit out for more than one hour after defrosting. Room temperature promotes the growth of harmful bacteria.
- For more even defrosting of larger foods, such as beef, lamb and veal roasts, use Auto Defrost.
- Be sure large meats are completely defrosted before cooking.
- When defrosted, food should be cool but softened in all areas. If still slightly icy, return to the microwave very briefly, or let it stand a few minutes.

Defrosting Guide



Food	Time	Comments
Breads, Cakes Bread, buns or rolls (1 piece) Sweet rolls (approx. 12 oz.)	1 min. 3 to 5 min.	
Fish and Seafood Fillets, frozen (1 lb.) Shellfish, small pieces (1 lb.)	6 to 8 min. 5 to 7 min.	Place block in casserole. Turn over and break up after half the time.
Fruit Plastic pouch—1 to 2 (10-oz. package)	3 to 6 min.	
Meat Bacon (1 lb.) Franks (1 lb.) Ground meat (1 lb.) Roast: beef, lamb, veal, pork Steaks, chops and cutlets	2 to 5 min 2 to 5 min 5 to 7 min 12 to 16 min. 5 to 7 min. per lb.	Place unopened package in oven. Let stand 5 minutes after defrosting. Place unopened package in oven. Microwave just until franks can be separated. Let stand 5 minutes, if necessary, to complete defrosting. Turn meat over after half the time Use power level 1. Place unwrapped meat in cooking dish. Turn over after half the time and shield warm areas with foil. When finished, separate pieces and let stand to complete defrosting.
Poultry Chicken, broiler-fryer cut up (21/2 to 3 lbs.)	15 to 19 min 17 to 21 min	Place wrapped chicken in dish. Unwrap and turn over after half the time. When finished, separate pieces and microwave 2–4 minutes more, if necessary. Let stand to finish defrosting.

Chicken, whole (2 1/2 to 3 lbs.)	7 to 13 min. per lb.	Place wrapped chicken in dish. After half the time, unwrap and turn chicken over. Shield warm areas with foil. Finish defrosting. If necessary, run cold water in the cavity until giblets can be removed.
Cornish hen	5 to 9 min. per lb.	Place unwrapped hen in the oven breast side-up. Turn over after half the time. Run cool water in the cavity until giblets can be removed.
Turkey breast (4 to 6 lbs.)		Place unwrapped breast in dish breast side-down. After half the time, turn over and shield warm areas with foil. Finish defrosting. Let stand 1–2 hours in refrigerator to complete defrosting

Express Cook



This is a quick way to set cooking time for 1 –6 minutes.

Press one of the Express Cook pads (from 1 to 6) for 1 to 6 minutes of cooking at power level 10. For example, press the 2 pad for 2 minutes of cooking time.

The power level can be changed as time is counting down. Press POWER LEVEL and enter 1–10.

Add 30 Seconds



You can use this feature two ways:

- It will add 30 seconds to the time counting down each time the pad is pressed.
- It can be used as a quick way to set 30 seconds of cooking time.

Convenience Features

Popcorn

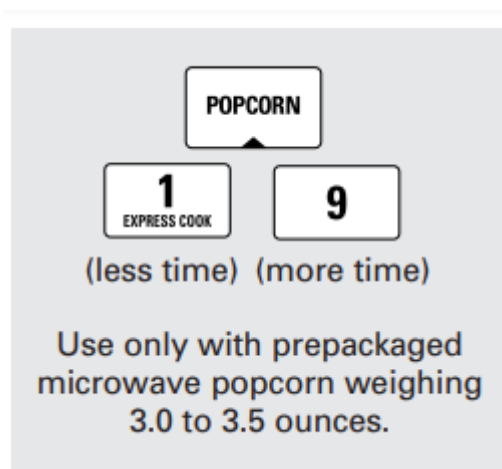

How to Use the Popcorn Feature

1. Follow package instructions, using Time Cook if the package is less than 3.0 ounces or larger than 3.5 ounces. Place the package of popcorn in the center of the microwave.
2. Press POPCORN. The oven starts immediately. Tap POPCORN to select the bag size you are cooking.

How to Adjust the Popcorn Program to Provide a Shorter or Longer Cook Time

If you find that the brand of popcorn you use underpops or overcooks consistently, you can add or subtract 20–30 seconds to the automatic popping time.

To add time:

After pressing POPCORN, press 9 immediately after the oven starts for an extra 20 seconds.

Press 9 again to add another 10 seconds (total 30 seconds additional time).

To subtract time:

After pressing POPCORN, press 1 immediately after the oven starts for 20 seconds less cooking time.

Press 1 again to reduce cooking time another 10 seconds (total 30 seconds less time).

Beverage



The Beverage feature heats 1–3 servings of any beverage.

Press BEVERAGE. The oven starts immediately.

The serving size is automatically set at 1, but can be changed by pressing 2 or 3 right after pressing BEVERAGE.

Drinks heated with the Beverage feature may be very hot. Remove the container with care.

Reheat

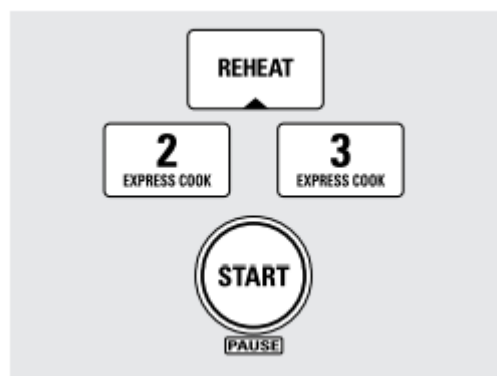

The Reheat feature reheats 1 to 3 servings of many previously cooked foods.

1. Press REHEAT.
2. Select food type 1–6 for one serving (see Reheat Guide below).
3. Press 2 or 3 to reheat 2 or 3 servings.
4. Press START.

NOTE: The serving size may be changed or added after pressing START. Press number pad 2 or 3

Reheat Guide

Food Type	Comments
1. Pasta	Cover with lid or vented plastic wrap.
2. Meats, casseroles, pizza	Cover with lid or vented plastic wrap.
3. Fruits and vegetables	Cover with lid or vented plastic wrap.
4. Beverages, 8–10 oz.	Works best with wide mouth mug—do not cover.
5. Sauces and gravies	Cover with lid or vented plastic wrap.
6. Plate of leftovers (2 to 3 foods, 4 oz. each)	Cover with vented plastic wrap

Potato



The Potato feature cooks up to four 8–10 ounce potatoes.

Press POTATO once for one potato, twice for two potatoes, three times for three potatoes and four times for four potatoes. The oven will start immediately after POTATO is pressed.

Vegetable

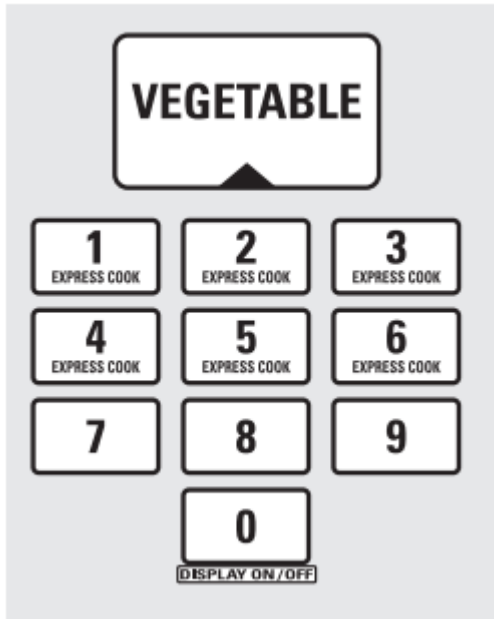

The Vegetable feature automatically sets the cooking times and power levels to cook fresh, frozen or canned vegetables.

1. Press VEGETABLE. “Select Veggie type 1–3” will be displayed.
2. Select food type 1–3 (see chart at right).
3. Enter weight in ounces (see chart at right).
4. The oven starts automatically.

<i>Food Code</i>	<i>Food</i>	<i>Weight</i>
1	Canned	4–20 oz
2	Frozen	4–20 oz
3	Fresh	4–16 oz.

Cook (On some models)



The Cook feature automatically sets the cooking times and power levels for a variety of foods.

1. Press COOK.
2. Select food type 1–9 (see the Cook Guide below).
3. Enter weight in ounces.
4. Press START.

Hint: Press and hold the COOK pad during cooking to display the food type and remaining cook time.

Cook Guide

Food Type	Weight	Comments
1. Canned Vegetables	4 to 20 oz	Use microwave-safe casserole or bowl. Cover with lid or vented plastic wrap
2. Frozen Vegetables	4 to 20 oz.	Use microwave-safe casserole or bowl. Follow package instructions for adding water. Cover with lid or vented plastic wrap.
3. Fresh Vegetables	4 to 16 oz	Use microwave-safe casserole or bowl. Add 2 tablespoons water for each serving. Cover with lid or vented plastic wrap.
4. Potatoes	8 to 40 oz	Pierce skin with fork. Place potatoes on oven floor or turntable.
5. Fish	4 to 16 oz.	Use oblong, square or round dish. Cover with vented plastic wrap or wax paper.
6. Chicken Pieces	4 to 40 oz	Use oblong, square or round dish. Cover with vented plastic wrap.
7. Ground Meat (beef, pork, turkey)	8 to 48 oz.	Use round casserole dish. Crumble meat into dish. Cover with lid or vented plastic wrap. Drain and stir at signal.
8. Bacon	2 to 10 oz.	Layer strips on a plate, 4 to a layer. Cover each layer with a paper towel.
9. Pizza (frozen, microwaveable)	4 to 16 oz	Follow package instructions to prepare pizza for microwaving

Auto Defrost



1. Press **DEFROST AUTO/TIME** once.
2. Using the *Conversion Guide* at right, enter food weight. For example, press pads **1** and **2** for 1.2 pounds (1 pound, 3 ounces).
3. Press **START**. (Time Defrost is explained in the *Time Features* section.)

The Defrost Auto/Time feature gives you two ways to defrost frozen foods. Press DEFROST AUTO/TIME once for Auto Defrost or twice for Time Defrost.

Use Auto Defrost for meat, poultry and fish. Use Time Defrost for most other frozen foods.

Auto Defrost automatically sets the defrosting times and power levels to give even defrosting results for meats, poultry and fish weighing up to 6 pounds.

There is a handy guide located on the inside front of the oven.

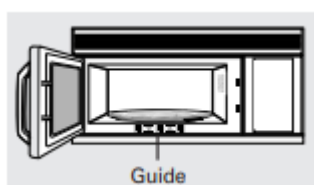

Conversion Guide

If the weight of food is stated in pounds and ounces, the ounces must be converted to tenths (.1) of a pound.

<i>Weight of Food in Ounces</i>	<i>Enter Food Weight (tenths of a pound)</i>
1–2	.1
3	.2
4–5	.3
6–7	.4
8	.5
9–10	.6
11	.7
12–13	.8
14–15	.9

- Remove meat from package and place on microwave-safe dish.
- Twice during defrost, the oven signals TURN. At each TURN signal, turn the food over. Remove defrosted meat or shield warm areas with small pieces of foil.
- After defrosting, most meats need to stand 5 minutes to complete defrosting. Large roasts should stand for about 30 minutes.

Other Features Your Model May Have

Help (On some models)



The HELP pad displays feature information and helpful hints. Press HELP, then select a feature pad.

Cooking Complete Reminder

To remind you that you have food in the oven, the oven will display “FOOD IS READY” and beep once a minute until you either open the oven door or press CLEAR/OFF.

Clock



Press to enter the time of day or to check the time of day while microwaving.

1. Press CLOCK.
2. Enter time of day.
3. Select AM or PM.
4. Press START or CLOCK.

Scroll Speed

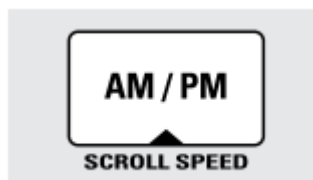

The scroll speed of the display can be changed. Press and hold the AM/PM pad about 3 seconds to bring up the display. Select 1–5 for slow to fast scroll speed.

Display On/Off



To turn the clock display off, press and hold 0 for about 3 seconds.

To redisplay the clock, repeat.

Delay Start



Delay Start allows you to set the microwave to delay cooking up to 24 hours.

1. Press DELAY START.
2. Enter the time you want the oven to start. (Be sure the microwave clock shows the correct time of day.)
3. Select AM or PM.
4. Select any combination of Defrost Auto/Time or Time Cook I & II.
5. Press START.

The Delay Start time will be displayed plus “DS.” The oven will automatically start at the delayed time.

The time of day may be displayed by pressing CLOCK.

Timer On/Off



Timer On/Off operates as a minute timer and can be used at any time, even when the oven is operating.

1. Press TIMER ON/OFF.
2. Enter time you want to count down.
3. Press TIMER ON/OFF to start.

When time is up, the oven will signal. To turn off the timer signal, press TIMER ON/OFF.

NOTE: The timer indicator will be lit while the timer is operating

Start/Pause



In addition to starting many functions, START/PAUSE allows you to stop cooking without opening the door or clearing the display

Reminder



The Reminder feature can be used like an alarm clock and can be used at any time, even when the oven is operating. The Reminder time can be set up to 24 hours later.

1. Press REMINDER.
2. Enter the time you want the oven to remind you. (Be sure the microwave clock shows the correct time of day.)
3. Select AM or PM.
4. Press REMINDER. When Reminder signal occurs, press REMINDER to turn it off. The Reminder time may be displayed by pressing REMINDER.

NOTE: The REM indicator will remain lit to show that the Reminder is set. To clear the Reminder before it occurs, press REMINDER, then 0. The REM indicator will no longer be lit.

Child Lock-Out



You may lock the control panel to prevent the microwave from being accidentally started or used by children.

To lock or unlock the controls, press and hold CLEAR/OFF for about three seconds. When the control panel is locked, an "L" will be displayed to the extreme right.

Turntable (On some models)



For best cooking results, leave the turntable on. It can be turned off for large dishes. Press TURNTABLE to turn the turntable on or off.

When the turntable is off, rotate the dish 1/2 turn after half the time for best results.

Sometimes the turntable can become too hot to touch. Be careful touching the turntable during and after cooking.

Surface Light



Press to turn the surface light on or off.

On some models, there is a night light option.

Press SURFACE LIGHT **once** for bright light, **twice** for the night light or **three** times to turn the light off.

Beeper Volume (On some models)



The beeper sound level can be adjusted. Press BEEPER VOLUME. Choose 0–3 for mute to loud.

Vent Fan



The vent fan removes steam and other vapors from surface cooking.

Press VENT FAN once for high fan speed, twice for low fan speed or a third time to turn the fan off.

Automatic Fan

An automatic fan feature protects the microwave from too much heat rising from the cooktop below it. It automatically turns on if it senses too much heat.

If you have turned the fan on you may find that you cannot turn it off. The fan will automatically turn off when the internal parts are cool. It may stay on for 30 minutes or more after the cooktop and microwave controls are turned off.

Shelf (On some models)

How to Use the Shelf When Microwaving

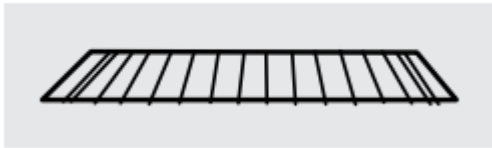

- Make sure the shelf is positioned properly inside the microwave to prevent damage to the oven from arcing.
- Do not use a microwave browning dish on the shelf. The shelf could overheat.
- Do not use the oven with the shelf on the microwave floor. This could damage the microwave.
- Use pot holders when handling the shelf— it may be hot.
- Do not use the shelf when cooking popcorn.
- Do not use the shelf with Sensor Cooking or Reheat.

Food microwaves best when placed on the turntable.

Only use the shelf when reheating on more than one level. Do not store the shelf inside the oven cavity.

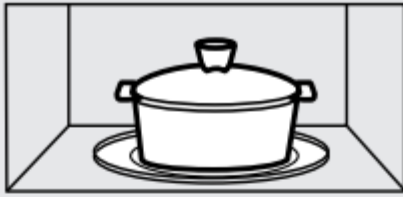

For best results

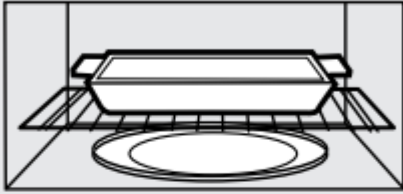

2-level reheating

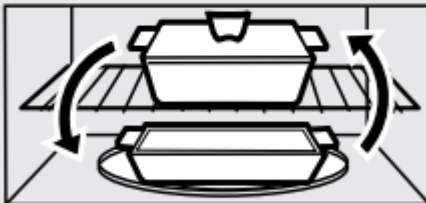

Switch places after 1/2 time.



Switch places after 1/2 time.

- To reheat on 2 levels

or

- To reheat 2 dishes on the lower level:

1. Multiply reheat time by 1 1/2.
2. Switch places after 1/2 the time.

Helpful Information

Microwave Terms

Term	Definition
Arcing	Arcing is the microwave term for sparks in the oven. Arcing is caused by: <ul style="list-style-type: none">• metal or foil touching the side of the oven.• foil that is not molded to food (upturned edges act like antennas).• metal such as twist ties, poultry pins, gold-rimmed dishes.• recycled paper towels containing small metal pieces.
Covering	Covers hold in moisture, allow for more even heating and reduce cooking time. Venting plastic wrap or covering with wax paper allows excess steam to escape.
Shielding	In a regular oven, you shield chicken breasts or baked foods to prevent over-browning. When microwaving, you use small strips of foil to shield thin parts, such as the tips of wings and legs on poultry, which would cook before larger parts.
Standing Time	When you cook with regular ovens, foods such as roasts or cakes are allowed to stand to finish cooking or to set. Standing time is especially important in microwave cooking. Note that a microwaved cake is not placed on a cooling rack.
Venting	After covering a dish with plastic wrap, you vent the plastic wrap by turning back one corner so excess steam can escape.

Care and Cleaning

Helpful Hints



An occasional thorough wiping with a solution of baking soda and water keeps the inside fresh.

NOTE: Be certain the power is off before cleaning any part of this oven.

How to Clean the Inside

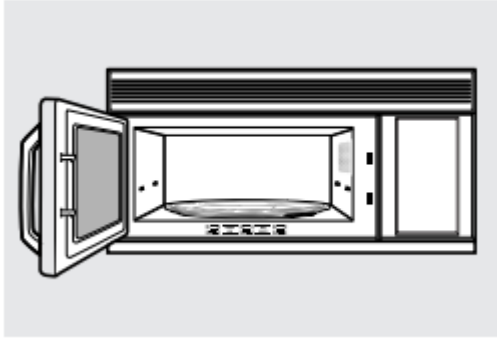

Walls, Floor, Inside Window, Metal and Plastic Parts on the Door

Some spatters can be removed with a paper towel, others may require a damp cloth. Remove greasy spatters with a sudsy cloth, then rinse with a damp cloth. Do not use abrasive cleaners or sharp utensils on oven walls. **Never use a commercial oven cleaner on any part of your microwave.**

Shelf (if included)

Clean with mild soap and water or in the dishwasher. **Do not clean in a self-cleaning oven.**

Removable Turntable and Turntable Support

To prevent breakage, do not place the turntable into water just after cooking. Wash it carefully in warm, sudsy water or in the dishwasher. The turntable and support can be broken if dropped. Remember, do not operate the oven without the turntable and support in place.

Temperature Probe (if included)

Clean immediately after using. To clean, wipe with a sudsy cloth, then rub lightly with a plastic scouring ball if necessary. Rinse and dry. The probe can also be washed in the dishwasher.

How to Clean the Outside

We recommend against using cleaners with ammonia or alcohol, as they can damage the appearance of the microwave oven. If you choose to use a common household cleaner, first apply the cleaner directly to a clean cloth, then wipe the soiled area.

Case

Clean the outside of the microwave with a sudsy cloth. Rinse and then dry. Wipe the window clean with a damp cloth.

Control Panel

Wipe with a damp cloth. Dry thoroughly. Do not use cleaning sprays, large amounts of soap and water, abrasives or sharp objects on the panel—they can damage it. Some paper towels can also scratch the control panel.

Door Panel

Before cleaning the front door panel, make sure you know what type of panel you have. Refer to the eleventh digit of the model number. “S” is stainless steel, “G” is Graphite, “L” is CleanSteel and “B”, “W” or “C” are plastic colors.

Stainless Steel

The stainless steel panel can be cleaned with Stainless Steel Magic or a similar product using a clean, soft cloth. Apply stainless cleaner carefully to avoid the surrounding plastic parts. Do not use appliance wax, polish, bleach or products containing chlorine on Stainless Steel finishes.

CleanSteel or Graphite

Use a clean, soft, light and lightly dampened cloth, then dry thoroughly. Do not use appliance wax, polish, bleach or products containing any chemical agent on the CleanSteel or Graphite surfaces.

Plastic Color Panels

Use a clean, soft, lightly dampened cloth, then dry thoroughly.

Door Seal

It's important to keep the area clean where the door seals against the microwave. Use only mild, non-abrasive detergents applied with a clean sponge or soft cloth. Rinse well.

Bottom

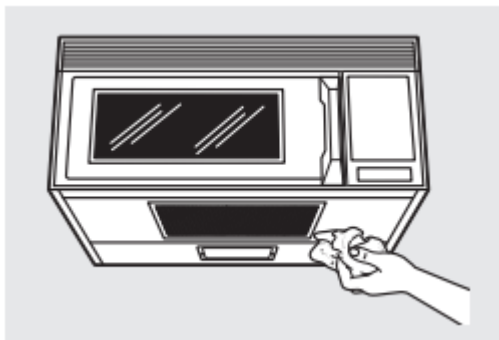

Clean off the grease and dust on the bottom often. Use a solution of warm water and detergent.

Light Bulb Replacement

Cooktop Light

Replace the burned-out bulb with a 120 volt, 40-watt incandescent bulb (WB36X10003), available from your GE supplier

1. To replace the bulb(s), first disconnect the power at the main fuse or circuit breaker panel or pull the plug.
2. Remove the screw at the front of the light cover and lower the cover.

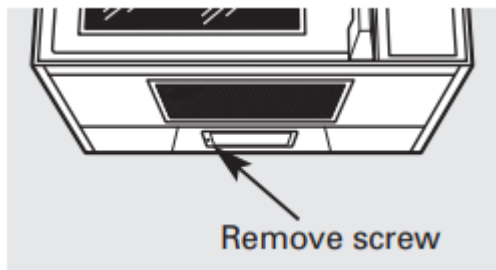

3. Be sure the bulb(s) to be replaced are cool before removing. After breaking the adhesive seal, remove the bulb by gently turning. Replace with the same size and type bulb.
4. Raise the light shield and replace the screw. Connect electrical power to the oven.



Oven Light

Replace the burned-out bulb with a 120 volt, 40-watt incandescent bulb (WB36X10003), available from your GE supplier.

1. To replace the oven light, first disconnect the power at the main fuse or circuit breaker panel or pull the plug.
2. Remove the top grille by taking out the 2 screws that hold it in place.

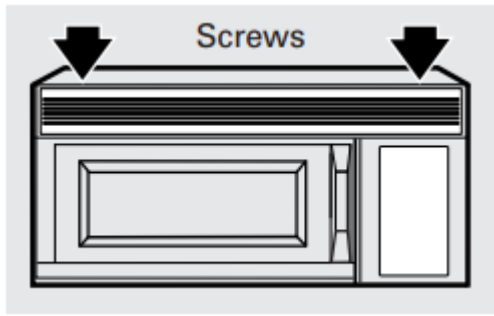

3. Remove the charcoal filter (if present) to access the light cover (see Remove Charcoal Filter section).

4. Remove the light cover located near the center of the oven that holds the bulb. After breaking the adhesive seal, remove the bulb by gently turning. Replace with the same size and type bulb.

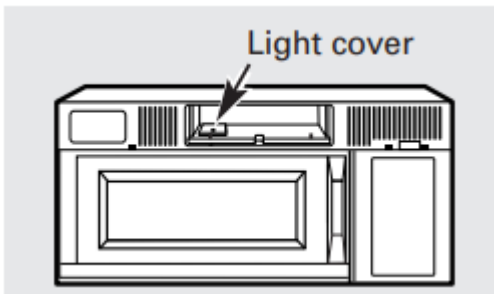

5. Replace the light cover and charcoal filter (if present).

6. Replace the grille and screws. Connect electrical power to the oven.

The Exhaust Feature

The Vent Fan

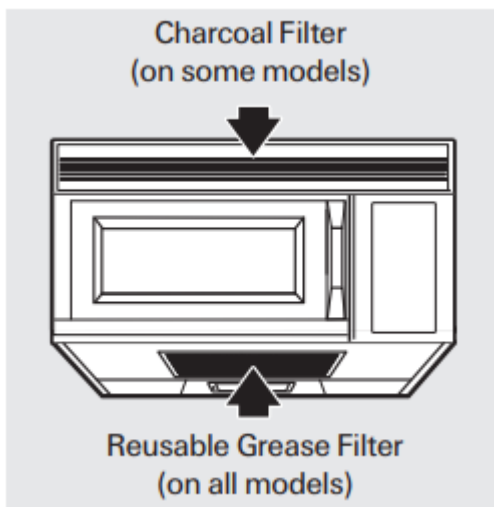

The vent fan has a metal reusable grease filter.

Models that recirculate air back into the room also use a charcoal filter

Reusable Grease Filter

The reusable grease filter traps grease released by foods on the cooktop. It also prevents flames from foods on the cooktop from damaging the inside of the microwave.

For this reason, the filter must ALWAYS be in place when the hood is used. The grease filter should be cleaned once a month, or as needed.

Removing and Cleaning the Filter



To remove, slide it to the side using the tab. Pull it down and out.

To clean the grease filter, soak it and then swish it around in hot water and detergent. Don't use ammonia or ammonia products because they will darken the metal. Light brushing can be used to remove embedded dirt. Rinse, shake and let it dry before replacing.

To replace, slide the filter in the frame slot on the left side of the opening. Pull up and to the right to lock into place.

Charcoal Filter (on some models)

The charcoal filter cannot be cleaned. It must be replaced. Order Part No. WB02X10943 from your GE supplier.

If the model is not vented to the outside, the air will be recirculated through a disposable charcoal filter that helps remove smoke and odors.

The charcoal filter should be replaced when it is noticeably dirty or discolored (usually after 6–12 months, depending on hood usage). See "Optional Kits," page 9, for more information

To Remove Charcoal Filter

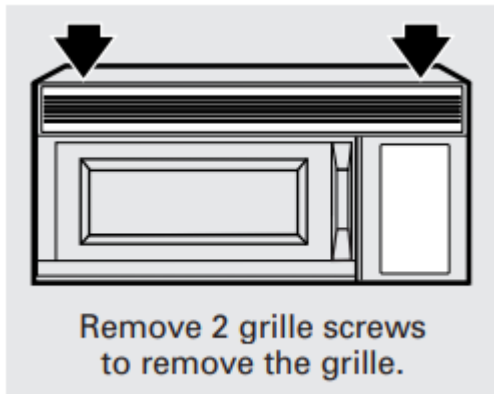

To remove the charcoal filter, disconnect power at the main fuse or circuit breaker panel or pull the plug.

Remove the top grille by removing the 2 screws that hold it in place. Pull the filter at the bottom until it comes free of the locking tabs. Slide the filter down and out.

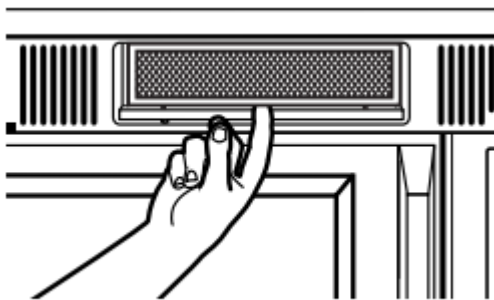

To Install Charcoal Filter

To install a new filter, remove plastic and other outer wrapping from the new filter.

1. Insert the top of the filter up and into the grooves on the inside of the top opening.

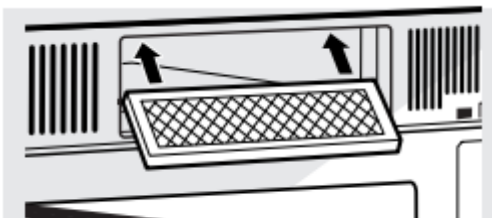

2. Push the bottom of the filter in until it snaps into place behind the locking tabs.

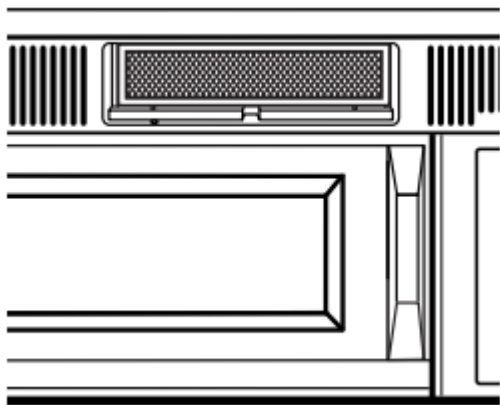

Warning

This content is compiled from multiple sources and is provided for reference purposes only. It may not be complete or fully applicable to all situations. If you are unable to resolve your issue, please contact the product manufacturer or an authorized service provider for official support.