

# INSTALLING YOUR DRYER

## UNPACKING YOUR DRYER

Unpack your Dryer and inspect it for shipping damage. Make sure you have received all of the items shown below. If your Dryer was damaged during shipping, or you do not have all of the items, contact 1-800- SAMSUNG(726-7864). To prevent personal injury or strain, wear protective gloves whenever lifting or carrying the unit.

 Packing materials can be dangerous to children; keep all packing material (plastic bags, polystyrene, etc.) well out of the reach of children.

## SEE EXHAUST REQUIREMENTS

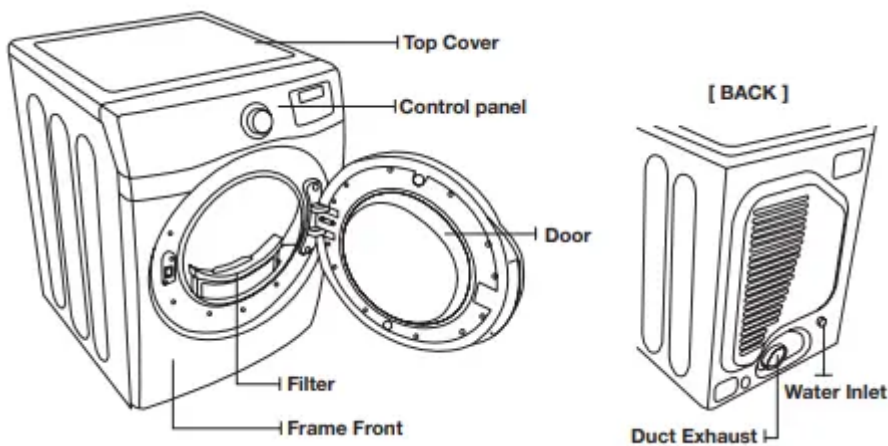

### Parts supplied

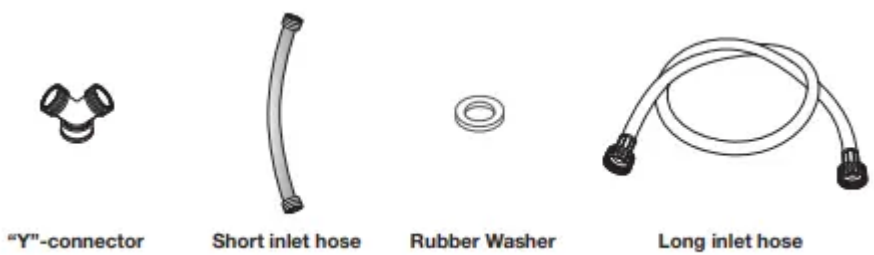

### Tools needed



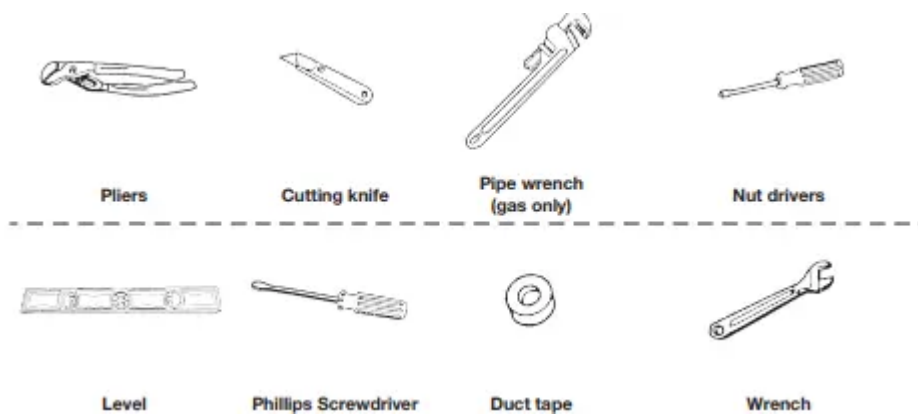

## BASIC REQUIRMENTS



Make sure you have everything necessary for proper installation

- A GROUNDED ELECTRICAL OUTLET is required. See Electrical Requirements.
- A POWER CORD electric dryers ( except for Canada).
- GAS LINES (if a gas dryer) must meet national and local codes.
- EXHAUST SYSTEM - must be rigid metal or flexible stiff-walled metal exhaust ducting.

## DUCTING REQUIREMENTS

- Use a 4-inch (10.2 cm) diameter rigid aluminum or rigid galvanized steel duct.
- Do not use a smaller duct.
- Ducts larger than 4 inches (10.2 cm) in diameter can result in increased lint accumulation. Lint accumulation should be cleaned regularly.
- If a flexible metal duct must be used, use the type with a stiff sheet metal wall. Do not use a flexible duct with a thin foil wall. Serious blockage can result if the flexible metal duct is bent too sharply.
- Never install any type of flexible duct in walls, ceilings, or other concealed spaces.
- Keep the exhaust duct as straight and short as possible.
- Secure joints with duct tape. Do not use screws.
- Plastic flexible duct can kink, sag, be punctured, reduce airflow, extend drying times, and affect dryer operation.
- Exhaust systems longer than recommended can extend drying times, affect machine operation, and may collect lint.
- The exhaust duct should end with an exhaust hood with a swing-out damper to prevent back drafts and entry of wildlife. Never use an exhaust hood with a magnetic damper.
- The hood should have at least 12 inches (30.5 cm) of clearance between the bottom of the hood and the ground or other obstruction. The hood opening should point down.

- Never install a screen over the exhaust outlet.
- To avoid lint buildup, do not exhaust the dryer directly into a window well. Do not exhaust under a house or porch.
- If exhaust ductwork must run through an unheated area, the duct should be insulated and slope slightly down towards the exhaust hood to reduce condensation and lint buildup.
- Inspect and clean the interior of the exhaust system at least once a year. Unplug the power cord before cleaning.
- Check frequently to be sure the exhaust hood damper opens and closes freely.
- Check once per month, and clean at least one time per year. Note: If clothes are not getting dry, then check ducting for obstructions.
- Do not exhaust dryer into any wall, ceiling, crawl space, or concealed space of a building, gas vent, or any other common duct or chimney. This could create a fire hazard from lint expelled by the dryer.

ELECTRIC AND GAS DRYER				
Weather Hood Type				
Recommended			Use only for short-run installation	
 4" (10.16 cm)			 2.5" (6.35 cm)	
No. of 90° elbows	Rigid	Metallic Flexible*	Rigid	Metallic Flexible*
0	24.4 m (80 ft.)	12.4 m (41 ft.)	22.6 m (74 ft.)	10.1 m (33 ft.)
1	20.7 m (68 ft.)	11.2 m (37 ft.)	18.9 m (62 ft.)	8.8 m (29 ft.)
2	17.4 m (57 ft.)	10.1 m (33 ft.)	15.5 m (51 ft.)	7.6 m (25 ft.)
3	14.3 m (47 ft.)	9.0 m (29 ft.)	12.5 m (41 ft.)	6.5 m (21 ft.)

\* Do not use non-metallic flexible duct.

## LOCATION CONSIDERATIONS

The dryer should be located where there is enough space at the front for loading the dryer, and enough space behind for the exhaust system. This dryer is factory-ready for rear exhaust. To exhaust out the bottom or the right or the left, use the accessory exhaust kit. Instructions are included with the kit. It's important to make sure the room has enough fresh air. The dryer must be located where there is no air-flow obstruction.

On gas dryers, adequate clearance as noted on the data plate must be maintained to ensure adequate air for combustion and proper dryer operation. The dryer must not be installed or stored in an area where it will be exposed to water and/or weather. The dryer area is to be kept clear of combustible materials, gasoline, and other flammable vapors and liquids. A dryer produces combustible lint. The area around the dryer should be kept Lint-Free.

## Installing your dryer

With optional pedestal base or stacking kit

### Required Dimensions for Installation With Pedestal

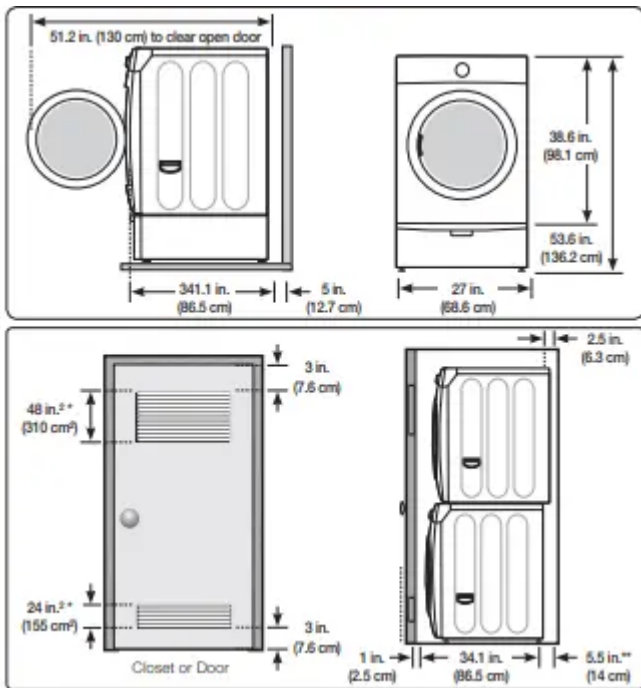

### Required Dimensions for Installation With Stacking Kit

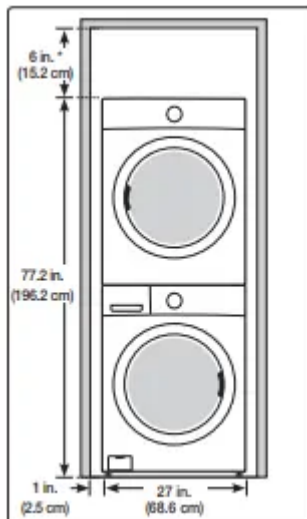

## ELECTRICAL REQUIREMENTS



• Improper connection of the equipment grounding conductor can result in a risk of electric shock. Check with a qualified electrician or serviceman if you are in doubt as to whether your dryer is properly grounded. Do not modify the plug provided with your dryer – if it doesn't fit the outlet, have a proper outlet installed by a qualified electrician.

- To prevent unnecessary risk of fire, electrical shock, or personal injury, all wiring and grounding must be done in accordance with local codes, or in the absence of local codes, with the National Electrical Code, ANSI/NFPA No. 70-Latest Revision (for the U.S.) or the Canadian Electrical Code CSA C22.1 – Latest Revisions and local codes and ordinances. It is your responsibility to provide adequate electrical services for your dryer.
- All gas installations must be done in accordance with the national Fuel Code ANSI/Z2231 – Latest Revision (for the U.S.) or CAN/CGA – B149 Installation Codes – Latest Revision (for Canada) and local codes and ordinances.

## GROUNDING

This dryer must be grounded. In the event of malfunction or breakdown, the ground will reduce the risk of electrical shock by providing a path of least resistance for the electrical current.



### Gas models

Your dryer has a cord with an equipment-grounding conductor and a grounding plug. The plug must be plugged into an appropriate outlet that is properly installed and grounded in accordance with all local codes and ordinances. Do not modify the plug provided with your dryer – if it doesn't fit the outlet, have a proper outlet installed by a qualified electrician. Never connect ground wire to plastic plumbing lines, gas lines, or hot water pipes.



### Electric models

Your dryer has a cord with an equipment-grounding conductor and a grounding plug, sold separately. The plug must be plugged into an appropriate outlet that is properly installed and grounded in accordance with all local codes and ordinances. Do not modify the plug provided with your dryer – if it doesn't fit the outlet, have a proper outlet installed by a qualified electrician. If a power cord is not used and the electric dryer is to be permanently wired, the dryer must be connected to a permanently grounded metal wiring system, or an equipment grounding conductor must be run with the circuit conductors and connected to the equipment grounding terminal.

## CONNECTING THE INLET HOSE

### Method1

The dryer must be connected to the cold water faucet using the new inlet hoses. Do not use old hoses.

1. If space permits, attach the brass female end of the “Y” connector to the cold water faucet.
2. Turn the cold water faucet off.
3. Attach the straight end of long hose to “Y” connector.
4. Using pliers, tighten the coupling with an additional two-thirds turn.



Do not overtighten, as it may damage the coupling.

5. Attach angled end of long hoses to fill the valve at the bottom of the dryer's rear frame. Screw on coupling by hand until it is seated on the fill valve connector.

6. Using pliers, tighten the coupling with an additional two thirds turn.

 Do not overtighten, as it may damage the coupling.

7. Check that the water faucets are on. 8. Check for leaks around "Y" connector, faucets and hoses.

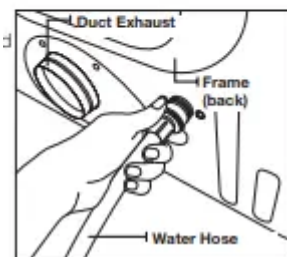
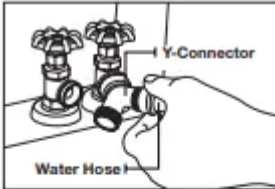

## Method2

The dryer must be connected to the cold water faucet using the new inlet hoses. Do not use old hoses.

1. If "Y" connector cannot be attached directly to the cold water faucet, the short hose must be used.

2. Turn the cold water faucet off.

3. Attach short inlet hose to cold water faucet. Screw on coupling by hand until it is seated on the faucet.

4. Using pliers, tighten the coupling with an additional twothirds turn.

 Do not overtighten, as it may damage the coupling.

5. Attach 'Y' connector to brass male end of small hose. Screw on coupling by hand until it is seated on connector.

6. Using pliers, tighten the coupling with an additional twothirds turn.

 Do not overtighten, as it may damage the coupling.

7. Attach angled end of long hoses to the fill valve at the bottom of the dryer rear frame. Screw on coupling by hand until it is seated on fi ll valve connector.

8. Using pliers, tighten the coupling with an additional twothirds turn.

 Do not overtighten, as it may damage the coupling.

9. Check that the water faucets are on.

10. Check for leaks around "Y" connector, faucets and hoses

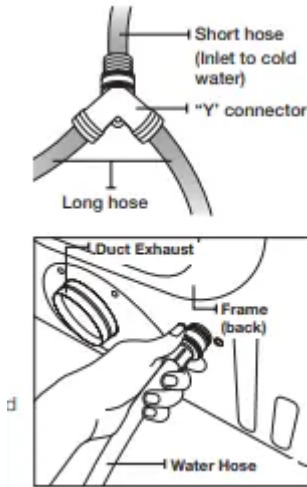

## INSTALLATION

For proper installation, we recommend that you hire a qualified installer.

### To install:

1. Move your dryer to an appropriate location for installation. Consider installing the dryer and washer side-by-side, to allow access to gas, electrical, and exhaust connections. Lay two of the carton cushion-tops on the floor. Tip your dryer on its side so it will lay across both cushion tops.
2. Set your dryer back in an upright position.
3. To ensure that the dryer provides optimal drying performance, it must be level. To minimize vibration, noise, and unwanted movement, the floor must be a perfectly level, solid surface.

 To set the dryer to the same height as the washer, fully retract the leveling feet by turning them counterclockwise, then loosen the leg by turning them clockwise

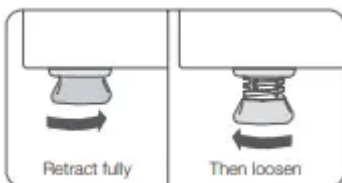

 Adjust the leveling feet only as much as necessary to level the dryer. Extending the leveling feet more than necessary can cause the dryer to vibrate.



4. Review the Exhausting section before installing the exhaust system. Install the ductwork from your dryer to the exhaust hood. The crimped end of the duct sections must point away from your dryer. DO NOT use sheet metal screws when assembling ducting. These joints should be taped. Never use plastic flexible exhaust material. Tip for tight installations: install a section of exhaust system to your dryer before putting it in place. Use duct tape to secure this section to your dryer, but do not cover ventilation slots at the back of the unit in dryer cabinet.

5. Review Electrical Requirements section. BEFORE OPERATING OR TESTING, follow the grounding instructions in the Grounding section.

6. Review Gas Requirements section. Remove the pipe thread protective cap. Apply pipe joint compound or about 1 1/2 wraps of Teflon tape over all threaded connections.



Pipe joint compound must be resistant to the action of any liquefied petroleum gas.

Connect the gas supply to your dryer. An additional fitting is required to connect the 3/4" (1.9 cm) female thread end of a flexible connector to the 3/8" (1 cm) male threaded end on the dryer. Securely tighten the gas line fitting over the threads. Turn on the gas supply. Check all gas connections for leaks using a soap solution. If bubbles appear, tighten the connections and recheck. DO NOT use an open flame to check for gas leaks

### **3-WIRE system connections**

1. Loosen or remove the center terminal block screw.
2. Connect the neutral wire (white or center wire) of the power cord to the center, silver-colored terminal screw of the terminal block. Tighten screw.
3. Connect the other wires to outer terminal block screws. Tighten screws.
4. Tighten the strain relief screws.
5. Insert the tab of the terminal block cover into your dryer's rear panel slot. Secure the cover with a hold-down screw.

1. External ground connector

2. Neutral grounding wire (green/yellow)
3. Center silver-colored terminal block screw
4. Neutral wire (white or center wire)
5. 3/4" (1.9 cm) UL-listed strain relief



If converting from a 4-wire electrical system to a 3-wire, the ground strap must be reconnected to the terminal block support to ground the dryer frame to the neutral conductor

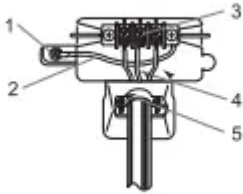

#### 4-WIRE system connections

1. Remove the center terminal block screw.
2. Connect the ground wire (green or unwrapped) of the power cord to the external ground conductor screw.
3. Connect the neutral wire (white or center wire) of the power cord and the appliance ground wire (green with yellow stripes) under the central screw of the terminal block.
4. Connect the other wires to the outer terminal block screws. Tighten screws.
5. Tighten the strain relief screws.
6. Insert the tab of the terminal block cover into your dryer's rear panel slot. Secure the cover with a hold-down screw.
  1. External ground connector
  2. Green or bare copper wire of power cord
  3. 3/4 in. (1.9 cm) UL-listed strain relief
  4. Center silver-colored terminal block screw
  5. Grounding wire (green/yellow)
  6. Neutral wire (white or center wire)
7. With a level, check your dryer and make necessary adjustments to the leveling legs.
8. At this time, make sure all gas connections (on gas models), exhaust and electrical connections are complete. Plug in your dryer, and check operation by using the checklist below.

9. (GAS MODELS ONLY) The burner may not ignite initially due to air in the gas line. Allowing your dryer to operate on a heat setting will purge the line. If the gas does not ignite within 5 minutes, turn your dryer off and wait 5 minutes. Be sure the gas supply



## FINAL INSTALLATION CHECKLIST







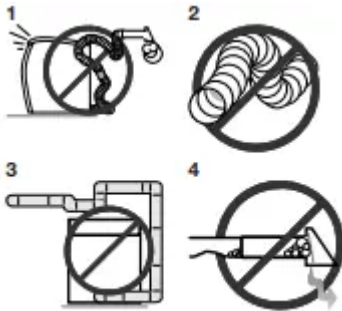

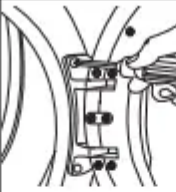

- Dryer is plugged into electrical outlet and is properly grounded.
- Exhaust ductwork is hooked up and joints are taped.
- Plastic flexible duct is NOT used.
- Used rigid or stiff-walled flexible metal vent material.
- Dryer is leveled and is sitting firmly on the floor.
- Gas models – gas is turned on with no gas leaks.
- Start your dryer to confirm that it runs, heats, and shuts off.

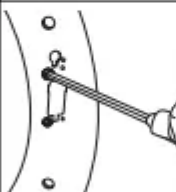
### Don't let a poor exhaust system slow drying by:

1. Restrict your dryer with a poor exhaust system.
2. Using a plastic, thin foil, or non-metal flexible duct.
3. Unnecessarily using long ducts that have many elbows.
4. Allowing crushed or clogged ducts and vents.

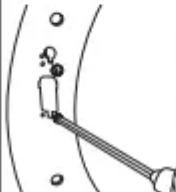

## DOOR REVERSAL

<ol style="list-style-type: none"> <li>1. Unplug the power cord.</li> <li>2. Remove two door hinge screws.</li> <li>3. Lift the door and remove it.</li> </ol>		<ol style="list-style-type: none"> <li>8. Remove a screw from the door hinge.  <input checked="" type="checkbox"/> The screw is for pre-fixing the door to the frame front.</li> </ol>	
<ol style="list-style-type: none"> <li>4. Remove two screws from the frame front.</li> </ol>		<ol style="list-style-type: none"> <li>9. Reassemble the screw in the other hole.</li> </ol>	
<ol style="list-style-type: none"> <li>5. Remove the two screws from the opposite side of the door hinge.</li> </ol>		<ol style="list-style-type: none"> <li>10. Place the door on the other side and reattach it to the dryer.</li> </ol>	
<ol style="list-style-type: none"> <li>6. Remove two screws from the holder lever.</li> </ol>		<ol style="list-style-type: none"> <li>11. Reattach the holder lever.</li> </ol>	
<ol style="list-style-type: none"> <li>7. Reassemble two screws on inside holes.</li> </ol>		<ol style="list-style-type: none"> <li>12. Reattach the screws in the remaining holes.</li> </ol>	

## Operating Instructions, tips

**DV511\***

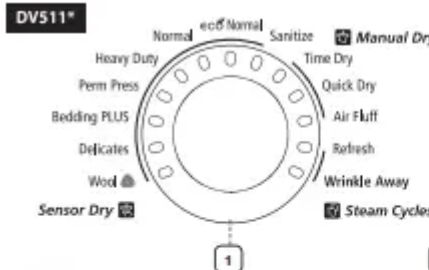

1

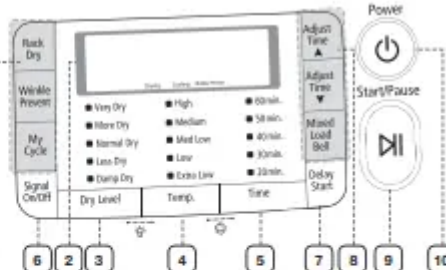

2 3 4 5 6 7 8 9 10

**DV501\***

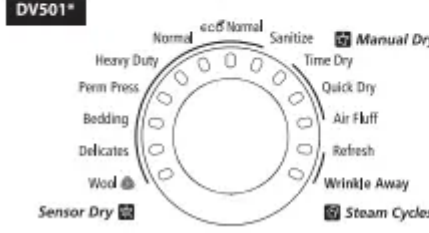

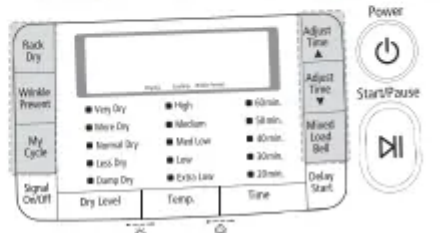

## Setting/Releasing

If you want to set or release the Child Lock, press both the Temp. and Time buttons simultaneously for 3 seconds.

#### **How to Set:**

1. It can be set while your dryer is running.
2. Once you set the Child Lock function, no button, except for the Power button, will respond until you release the Child Lock function.
3. The Child Lock indicator will be lit.

 1. If the dryer is powered on again, the Child Lock function stays on.

2. To release that function, follow the instructions above.

 When other buttons, except for the Power button, do not respond, check the Child Lock indicator.

## **DRUM LIGHT**

Lights the dryer drum while the dryer is running

#### **Setting & releasing**

If you want to set or release the Drum Light, press both the Dry Level and Temp. buttons simultaneously.

 It can be set while your dryer is not only running but also when it is stopped. If you do not turn the Drum Light off 5 minutes after turning it on, the Drum Light is automatically turned off.

## **CHANGING LANGUAGE**

You may change the language shown in the display from English to French or Spanish. Press and hold the Rack Dry and Wrinkle Prevent buttons for 3 seconds until the display changes. Then select the desired language by pressing the Signal button. Once set, the selected language will remain in memory, even if the dryer is turned off or unplugged.

## **MY CYCLE**

Lets you activate your customized cycle that includes Dry Level, Temp, Time option, etc. By pushing the My Cycle button, you activate the settings used during the previous My Cycle mode. (Default: Normal Cycle) If My Cycle mode is activated, the My Cycle indicator will be lit. You can select all options in My Cycle mode as follows.

1. Select cycle using the Cycle Selector dial.
2. After cycle selection, set each option.

 Each cycle has certain default options that are automatically set.

3. Then, you can start My Cycle by pushing the Start/Pause button in My Cycle mode. The cycle and options you select will be displayed the next time you choose My Cycle.

 You can change the My Cycle settings by repeating the same process above. The last used setting will be displayed the next time you choose My Cycle.

## RACK DRY

### Installing the drying rack

1. Open the dryer door.
2. Position drying rack in tumbler, placing the front lip of the drying rack on the top of the lint filter.
3. Place the rear legs in the two recessed areas of the dryer's back wall then push down the middle of the drying rack to fix.
4. Place the items to be dried on the rack, leaving space between them so air can circulate.
5. Close the dryer door.
6. Press the RACK DRY button at Time Dry cycle and then select the time according to the moisture and weight of item. The drying rack can be also used at Air Fluff cycle.

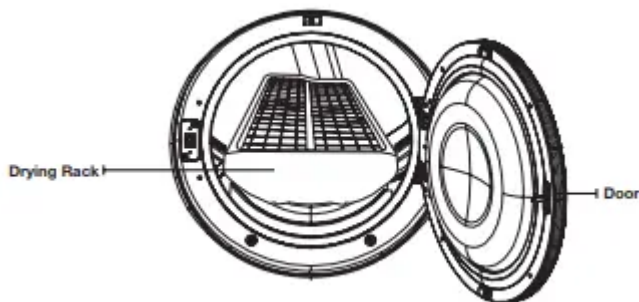

SUGGESTED ITEMS	SUGGESTED TEMP. SETTINGS
Washable sweaters (block to shape and lay flat on rack)	Extra Low ( Time Dry cycle)
Stuffed toys (cotton or polyester fiberfilled)	Extra Low ( Time Dry cycle)
Stuffed toys (foam or rubber-filled)	Air Fluff
Foam rubber pillows	Air Fluff
Sneakers	Air Fluff



Drying foam rubber, plastic, or rubber on a heat setting may cause damage to the items and lead to a fire hazard.

## CLEAN THE LINT FILTER

- After each load.

- To shorten drying time.
- To operate more energy efficiently.

 Do not operate your dryer without the lint filter in place.

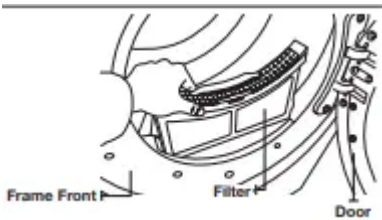

## LOAD THE DRYER PROPERLY

- Place only one washload in your dryer at a time.
- Mixed loads of heavy and lightweight fabrics will dry differently, which may result in lightweight fabrics being dry while heavy fabrics remain damp at the end of a drying cycle.
- Add one or more similar items to your dryer when only one or two articles of clothing need drying. This improves the tumbling action and drying efficiency.
- Overloading restricts tumbling action, resulting in uneven drying as well as excessive wrinkling of some fabrics.

## GETTING STARTED

1. Load your dryer loosely – DO NOT overload.
2. Close the door.
3. Select the appropriate cycle and options for the load.
4. Press the Start/Pause button.
5. The dryer indicator light will illuminate.
6. The estimated cycle time will appear in the display. The time may fluctuate as humidity levels fluctuate in the dryer.

 • When the cycle is complete, the Door Lock light will go out and “End” will appear in the display.

- Pressing Power cancels the cycle and stops your dryer.
- The Drying, Cooling, and Wrinkle Prevent indicator lights will illuminate during those portions of the cycle.



Do not place anything on top of your dryer while it is running.

## Care and cleaning

### CONTROL PANEL

Clean with a soft, damp cloth. Do not use abrasive substances. Do not spray cleaners directly on the panel. The control panel finish may be damaged by some laundry pre-treatment soil and stain remover products. Apply such products away from your dryer and wipe up any spills or overspray immediately.

### TUMBLER

Remove any stains such as crayon, ink, or fabric dye (from new items such as towels or jeans) with an allpurpose cleaner. Tumble old towels or rags to remove any excess stain or cleaning substance. Once these steps are followed, stains may still be visible, but should not transfer to subsequent loads.

### STAINLESS STEEL TUMBLER

To clean the stainless steel tumbler, use a damp cloth with a mild, non-abrasive cleaner suitable for stainless steel surfaces. Remove the cleaner residue and dry with a clean cloth.

### DRYER EXTERIOR

Clean with a soft, damp cloth. Do not use abrasive substances. Protect the surface from sharp objects. Do not place any heavy or sharp objects or a detergent box on the dryer. Keep them on the purchased pedestal or in a separate storage box. This may scratch or damage the top cover of the dryer. Since the entire dryer has a high-gloss finish, the surface can be scratched or damaged. Therefore, avoid scratching or damaging the surface when using the dryer.

### DRYER EXHAUST SYSTEM

Should be inspected and cleaned yearly to maintain optimum performance. The outside exhaust hood should be cleaned more frequently to ensure proper operation.

## Troubleshooting

### CHECK THESE POINTS IF YOUR DRYER...

#### Doesn't run.

- Make sure the door is latched shut.
- Be sure the power cord is plugged into a live electrical outlet.
- Check the home's circuit breaker and fuses.
- Press the Start/Pause button again if the door is opened during the cycle.

#### Doesn't heat.

- Check the home's circuit breaker and fuses.

- Select a heat setting other than Air Fluff.
- On a gas dryer, check that the gas supply is on.
- Clean the lint filter and exhaust duct.
- Dryer may have moved into the cool-down phase of the cycle.

#### **Doesn't dry.**

- Check all of the above, plus...
- Be sure the exhaust hood outside the home can open and close freely.
- Check exhaust system for lint buildup. Ducting should be inspected and cleaned annually.
- Use a 4" rigid metal exhaust duct.
- Do not overload. 1 wash load = 1 dryer load.
- Sort heavy items from lightweight items.
- Large, bulky items like blankets or comforters may require repositioning to ensure even drying.
- Check that the washer is draining properly to extract adequate water from the load.
- Load may be too small to tumble properly. Add a few towels.

#### **Is noisy.**

- Check the load for objects such as coins, loose buttons, nails, etc. Remove promptly.
- It is normal to hear the dryer gas valve or heating element cycle on and off during the drying cycle.
- Be sure the dryer is leveled properly as outlined in the installation instruction.
- It is normal for the dryer to hum due to the high velocity of air moving through the dryer drum and exhaust system.

#### **Dries unevenly.**

- Seams, pockets, and other similarly heavy areas may not be completely dry when the rest of the load has reached the selected dryness level. This is normal. Select the Very Dry setting if desired.
- If one heavy item is dried with a lightweight load, such as one towel with sheets, it is possible that the heavy item will not be completely dry when the rest of the load has reached the selected dryness level. Sort heavy items from lightweight items for best drying results.

#### **Has an odor.**

- Household odors from painting, varnishing, strong cleaners, etc. may enter the dryer with the surrounding room air. This is normal as the dryer draws the air from the room, heats it, pulls it through the tumbler, and exhausts it outside.

- When these odors linger in the air, ventilate the room completely before using the dryer.

### **Shuts off before load is dry**

- Dryer load is too small. Add more items or a few towels and restart the cycle.
- Dryer load is too large. Remove some items and restart the dryer.

### **Lint on clothes**

- Make sure the lint filter is cleaned before every load. With some loads that produce high amounts of lint, it may be necessary to clean the filter during the cycle.
- Some fabrics are lint producers (for example, a fuzzy white cotton towel) and they should be dried separately from clothes that are lint trappers (for example, a pair of lack linen pants)
- Divide larger loads into smaller loads for drying
- Check pockets thoroughly before washing and drying clothes.

### **Garments still wrinkled after Wrinkle-Care**

- Small loads of 1 to 4 items work best.
- Load fewer garments. Load similar-type garments.

### **Odors remain in clothing after Refresh.**

- Fabrics containing strong odors should be washed in a normal cycle.

### **Water drips from nozzle when Steam-Care starts**

- This is steam condensation. The dripping water will stop after a short time.

### **Sprayed water is not visible during Steam-Care**

- Sprayed water is difficult to see when the door is closed

## **INFORMATION CODES**

### **Code tE**

- Clogged Lint Screen Vent is restricted
  - Clean the screen or vent.
  - If the problem continues call for service

### **Code dE**

- Running the dryer with door open
  - Close the door and then restart.
  - If the problem continues call for service.

**Code dF**

- Door is not closing properly
  - Call for service.

**Code bE2**

- Invalid state of key circuit short for 30secs
  - Make sure a button is NOT being pressed continuously. Try restarting the cycle.
  - If the problem continues call for service.

**Code HE**

- Invalid heating Temp in running the dryer
  - Call for service.

**Code FE**

- Invalid power source Frequency
  - Try restarting the cycle.
  - If the problem continues call for service.

**Code AE**

- Electronic Control Problem (Communication Error)
  - Call for service.

**Code 2E**

- Electronic Control Problem (Over Voltage Error)
  - Call for service.

## SPECIFICATIONS

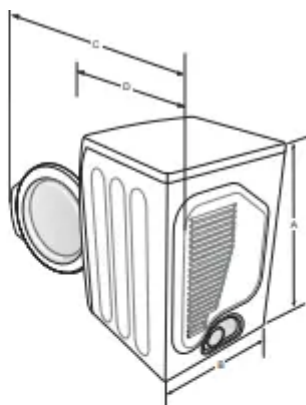

TYPE	FRONT LOADING DRYER			
DIMENSIONS	Div	Inches (cm)	Div	Inches (cm)
	A. Height	39" (99.1)	C. Depth with door open 90°	51.65"(131.2)
	B. Width	27" (68.6)	D. Depth	32.28"(82.0)
WEIGHT	127.8 lb (58Kg)			
HEATER RATING	5300 W (Elec.) 22000 BTU/hr (Gas)			
POWER CONSUMPTION	NO HEAT		268 W	
	HEATING		5445 W (Elec.) 268 W (Gas)	

### Warning

This content is compiled from multiple sources and is provided for reference purposes only. It may not be complete or fully applicable to all situations. If you are unable to resolve your issue, please contact the product manufacturer or an authorized service provider for official support.