

General information

Overview

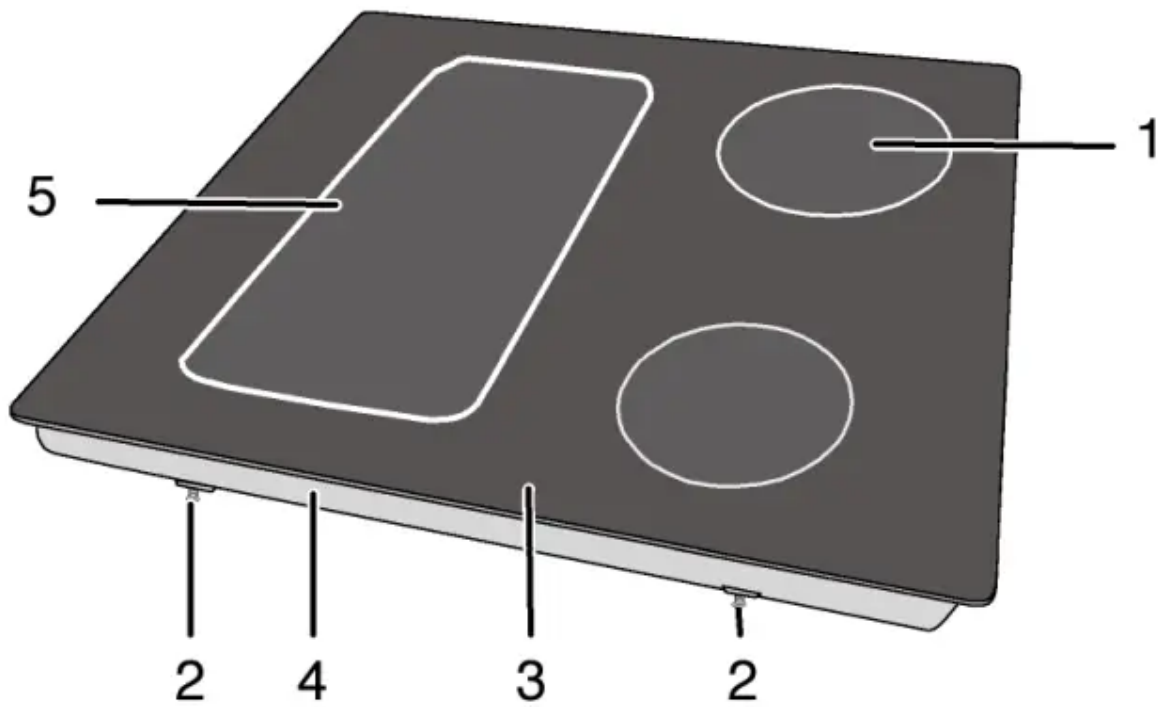

1. Induction cooking plate
2. Assembly clamp
3. Vitroceramic surface
4. Base cover
5. Induction cooking plate

Technical specifications

Voltage / frequency	1N ~ 220-240 V/ 2N ~ 380-415 V ~ 50 Hz
Total power consumption	max. 7200 W
Fuse	32 A / 16 A x 2
Cable type / section	min.H05V2V2-F 5 x 1,5 mm ²
External dimensions (height / width / depth)	55 mm/580 mm/510 mm
Installation dimensions (width / depth)	560 (+2) mm/490 (+2) mm
Burners	
Rear left	Induction cooking plate
Dimension	180 mm
Power	1800/3000 W
Front left	Induction cooking plate
Dimension	180 mm
Power	1800/3000 W
Front right	Induction cooking plate
Dimension	145 mm
Power	1500/2200 W
Rear right	Induction cooking plate
Dimension	210 mm
Power	2000/3700 W

Technical specifications may be changed without prior notice to improve the quality of the product.

Figures in this manual are schematic and may not exactly match your product.

Values stated on the product labels or in the documentation accompanying it are obtained in laboratory conditions in accordance with relevant standards. Depending on operational and environmental conditions of the product, these values may vary

Installation

Product must be installed by a qualified person in accordance with the regulations in force. The manufacturer shall not be held responsible for damages arising from procedures carried out by unauthorized persons which may also void the warranty.

Preparation of location and electrical installation for the product is under customer's responsibility.

DANGER: The product must be installed in accordance with all local electrical regulations.

DANGER: Prior to installation, visually check if the product has any defects on it. If so, do not have it installed. Damaged products cause risks for your safety.

Before installation The hob is designed for installation into commercially available work tops. A safety distance must be left between the appliance and the kitchen walls and furniture. See figure (values in mm).

- It can also be used in a free standing position. Allow a minimum distance of 750 mm above the hob surface.

not be liable for any damages that will arise due to using the product without a grounding installation in accordance with the local regulations.

DANGER: mains supply only by an authorised and qualified person. The product's warranty period starts from date of sale or date of delivery. Manufacturer shall not be held responsible for damages arising from procedures carried out by unauthorised persons.

DANGER: The power cable must not be clamped, bent or trapped or come into contact with hot parts of the product. A damaged power cable must be replaced by a qualified electrician.

Otherwise, there is risk of electric shock, short circuit or fire!

- Connection must comply with national regulations.
- The mains supply data must correspond to the data specified on the type label of the product. Type label is at the rear housing of the product.
- Power cable of your product must comply with the values in "Technical specifications" table.

DANGER: Before starting any work on the electrical installation, disconnect the product from the mains supply. There is the risk of electric shock!

Connecting the power cable

While performing the wiring, you must apply with the national/local electrical regulations and must use the appropriate socket outlet/line and plug for oven. In case of the product's power limits are out of current carrying capability of plug and socket outlet/line, the product must be connected through fixed electrical installation directly without using plug and socket outlet/line.

1. If it is not possible to disconnect all poles in the supply power, a disconnection unit with at least 3 mm contact clearance (fuses, line safety switches, contactors) must be connected and all the poles of this disconnection unit must be adjacent to (not above) the product in accordance with IEE directives. Failure to obey this instruction may cause operational problems and invalidate the product warranty. Additional protection by a residual current circuit breaker is recommended.

If a cable is supplied with the product:

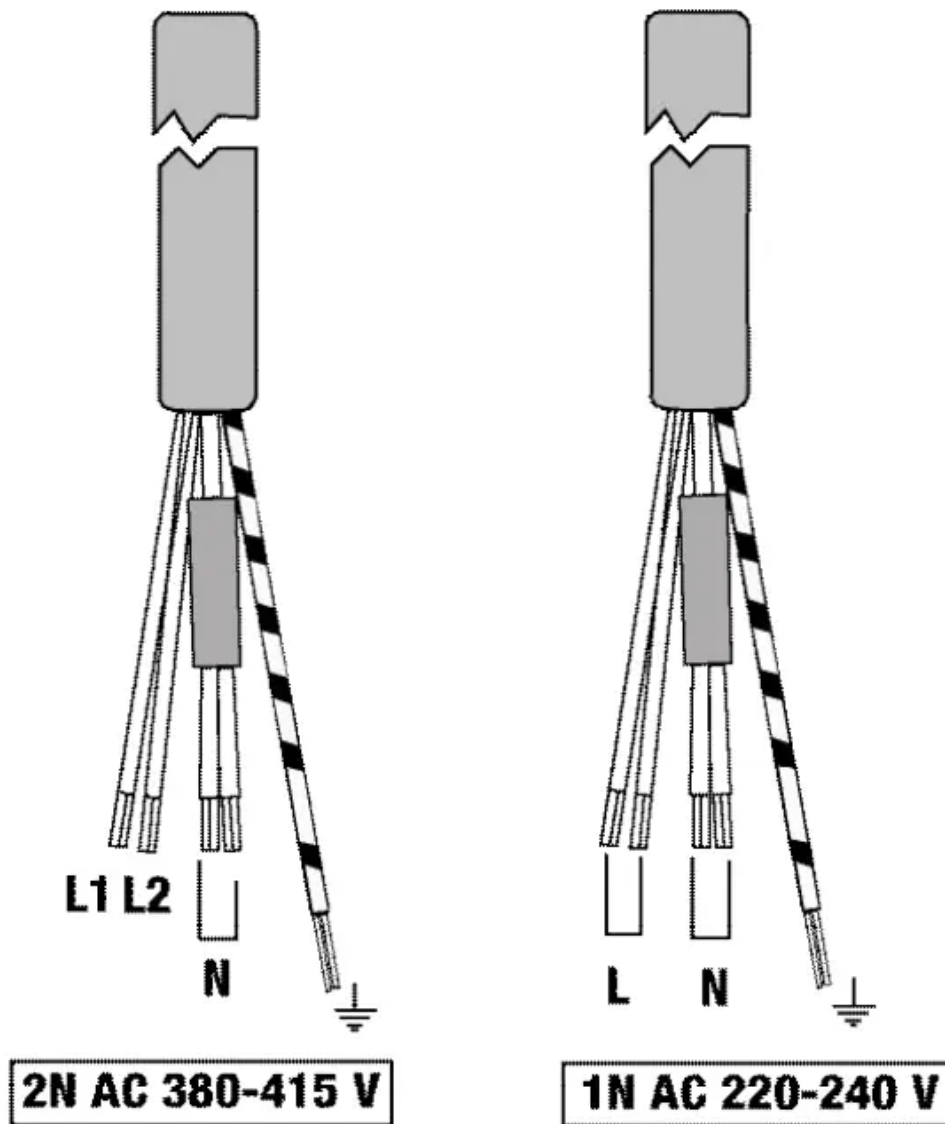

2. For single-phase connection, connect the wires as identified below:

- Brown/Black cable = L (Phase)
- Blue/Grey cable = N (Neutral)
- Green/yellow cable = (E)  (Ground)

» or

- Grey/Black cable = L (Phase)
- Blue/Brown cable = N (Neutral)
- Green/yellow cable = (E)  (Ground)

3. For double-phase connection, connect the wires as identified below:

- Brown cable = L1 (Phase 1)
- Black cable = L2 (Phase 2)

- Blue/Grey cable = N (Neutral)
- Green/yellow cable = (E)  (Ground)

» or

- Black cable = L1 (Phase 1)
- Grey cable = L2 (Phase 2)
- Blue/Brown cable = N (Neutral)
- Green/yellow cable = (E)  (Ground)

Installing the product If the oven is below:

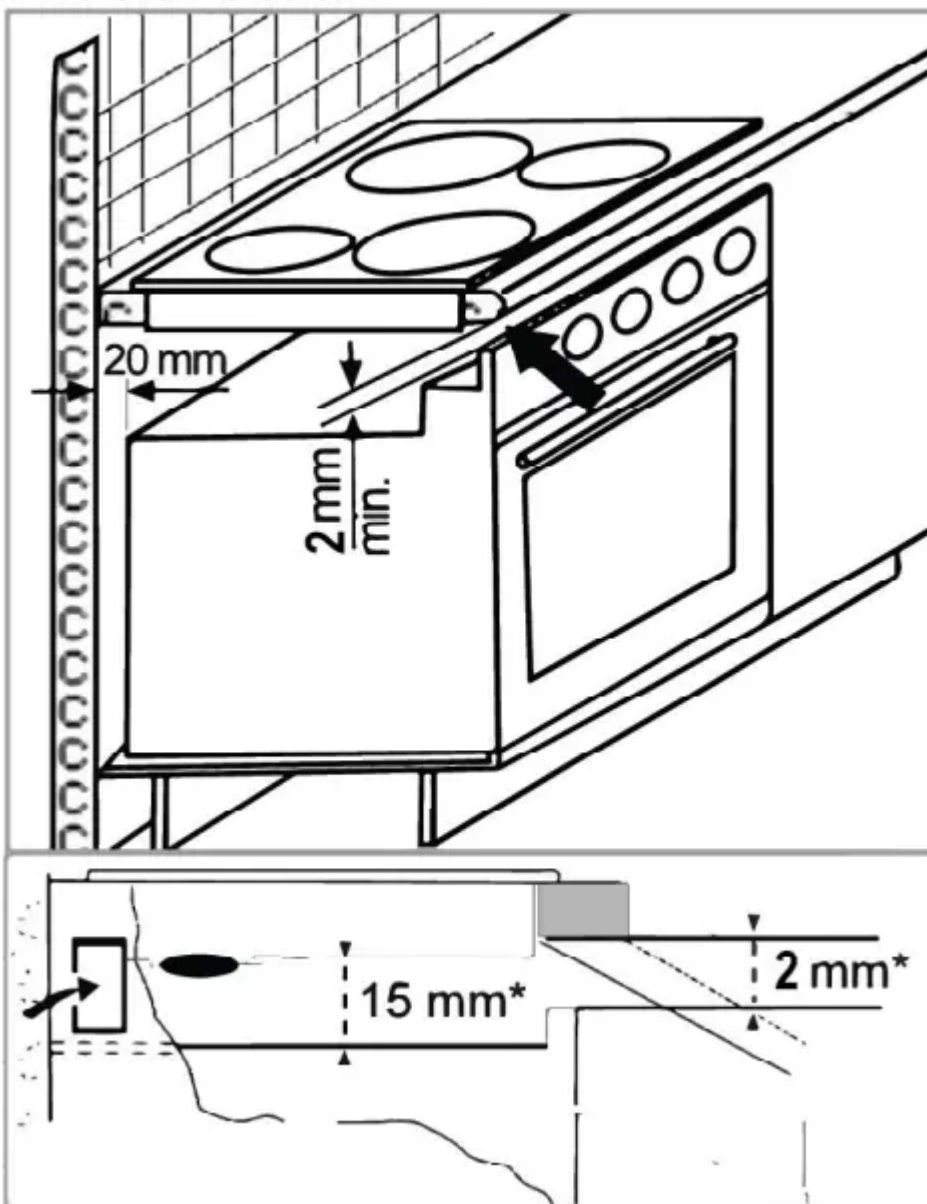

* min.

If the board is below:

It is required to leave a ventilation opening of minimum 180 cm² at the rear section of the furniture as illustrated in the following figure.

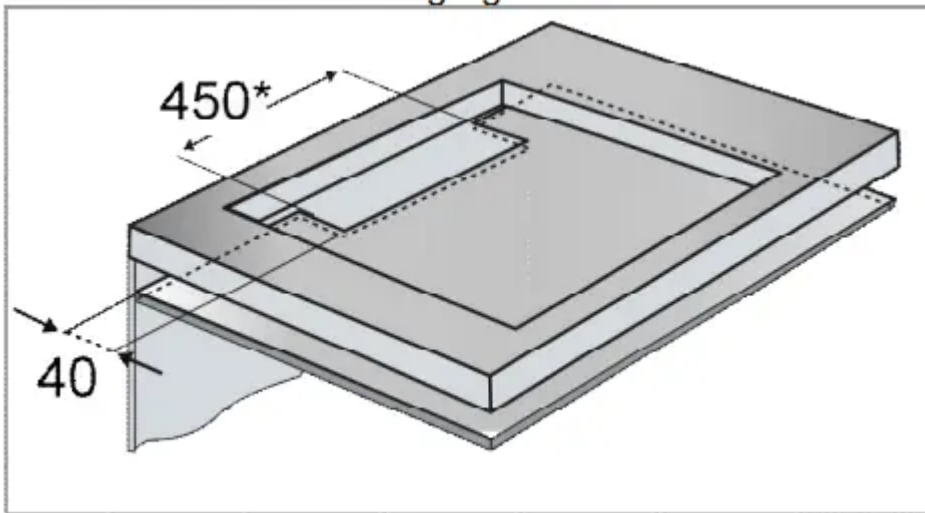

* min.

During installation of your induction hob, place the product parallel to the installation surface. Also, apply sealing gasket to the parts of the hob contacting the counter as described below in order to prevent any liquid from penetrating between the product and the counter.

1. Prepare the surface of the counter as shown in the figure.
2. Turning the hob upside down, place it on a flat surface.
3. The sealing gasket provided in the package must be applied on the lower casing bend around the hob as shown in the figure, during installation of the hob.



4. Fix the mounting springs inserting and screwing them through the holes of the bottom case as shown in the figure.

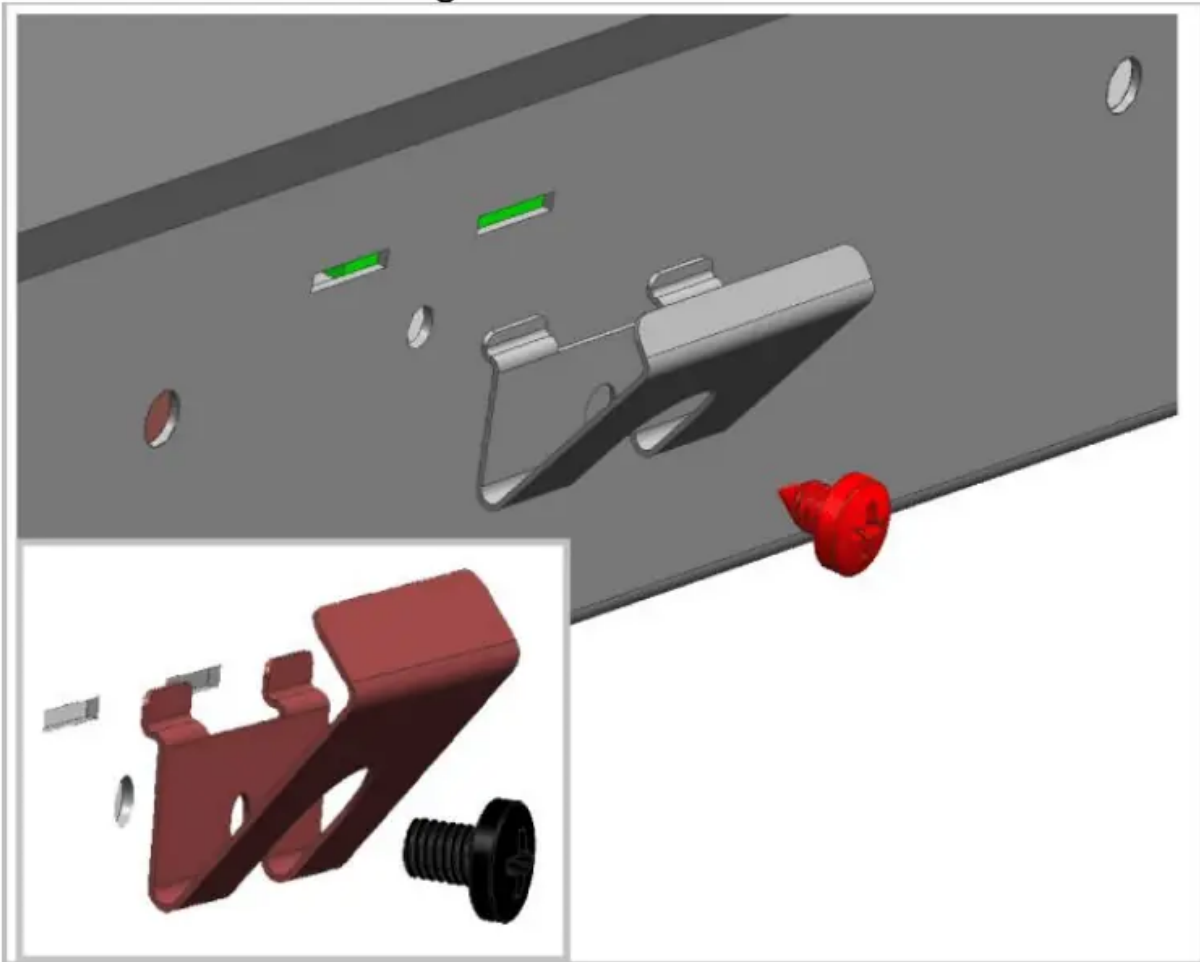

For some models, your product may come with the mounting springs already fitted on it. The number of mounting springs on your product varies depending on product model.

5. Place the hob on the counter and align it.

6. When the hob is placed on the counter top it will be fixed easily with the help of the clamps. If the installation with these clamps is not sufficient for your cooktop, additional 2 mounting clamps can be fixed to the front side of the product as shown in the below figure.

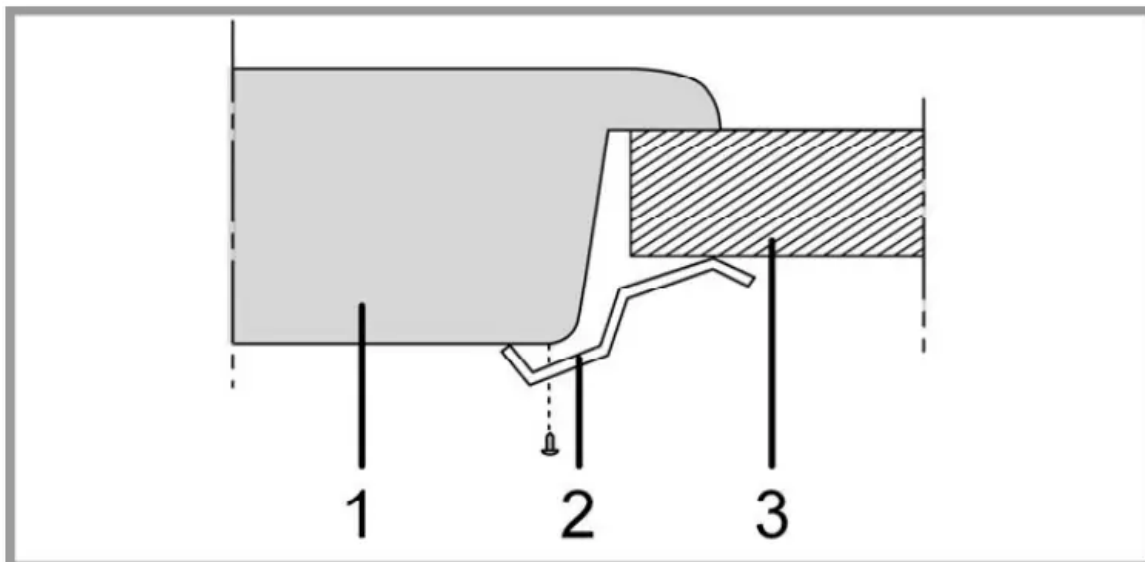

- 1 Hob
- 2 Installation clamp
- 3 Counter

When installing the hob onto a cabinet, a shelf must be installed in order to separate the cabinet from the hob as illustrated in the above figure. This is not required when installing onto a built-under oven.

For example, if it is possible to touch the bottom of the product since it is installed onto a drawer, this section must be covered with a wooden plate.

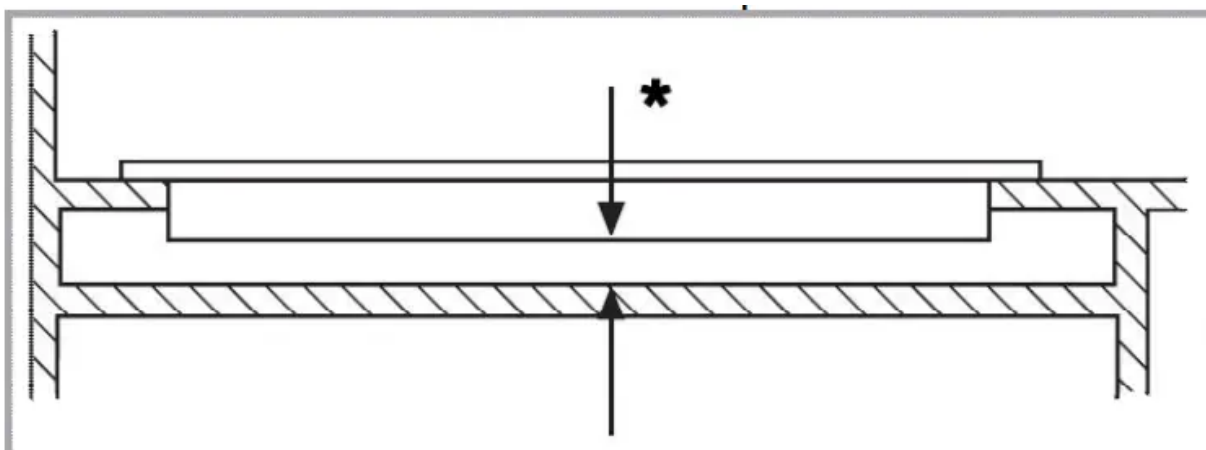

* min. 15 mm

Rear view (connection holes)

Location of the connection holes shown in the below figure are schematic, may vary depending on the product model. Fix them according to connection holes on your product.

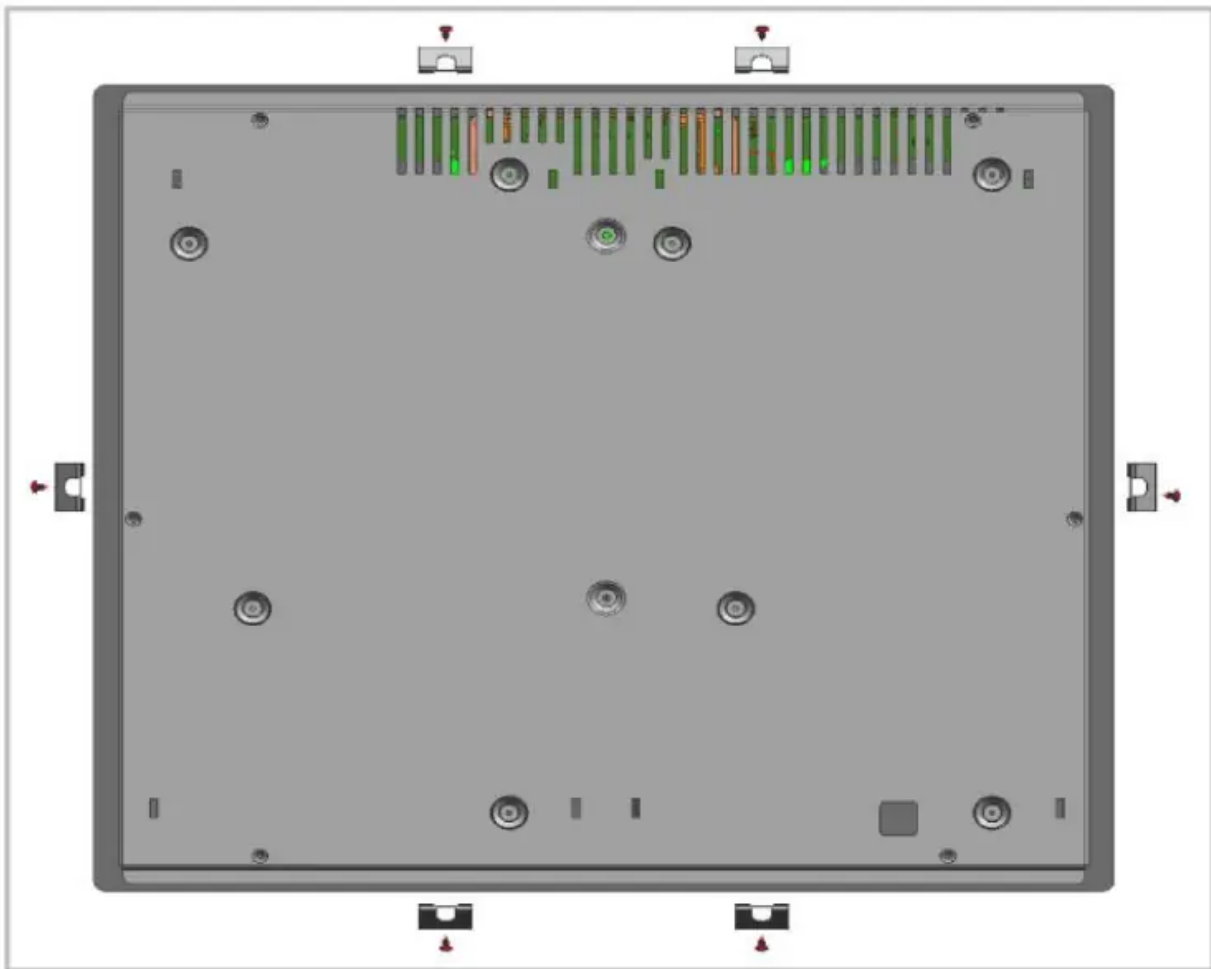

DANGER: Making connections to different holes is not a good practice in terms of safety since it can damage the gas and electrical system.

DANGER: There are electrical components contained within this hob, therefore when fitting the mounting springs/clamps only attach the supplied fixings to the connection holes shown in this manual. Failure to observe this advise may lead to life and property safety

The number of mounting springs on your product varies depending on product model.

Final check

1. Operate the product.
2. Check the functions.

Preparation

Tips for saving energy

The following information will help you to use your appliance in an ecological way, and to save energy:

- Defrost frozen dishes before cooking them.
- Use pots/pans with cover for cooking. If there is no cover, energy consumption may increase 4 times.
- Select the burner which is suitable for the bottom size of the pot to be used. Always select the correct pot size for your dishes. Larger pots require more energy.
- Pay attention to use flat bottom pots when cooking with electric hobs. Pots with thick bottom will provide a better heat conduction. You can obtain energy savings up to 1/3.
- Vessels and pots must be compatible with the cooking zones. Bottom of the vessels or pots must not be smaller than the hotplate. K
- Keep the cooking zones and bottom of the pots clean. Dirt will decrease the heat conduction between the cooking zone and bottom of the pot.

Initial use

First cleaning of the appliance

The surface might get damaged by some detergents or cleaning materials. Do not use aggressive detergents, cleaning powders/creams or any sharp objects during cleaning. Do not use harsh abrasive cleaners or sharp metal scrapers to clean the oven door glass since they can scratch the surface, which may result in shattering of the glass.

1. Remove all packaging materials.
2. Wipe the surfaces of the appliance with a damp cloth or sponge and dry with a cloth.

Initial heating

Smoke and smell may emit for a couple of hours during the initial operation. This is quite normal. Ensure that the room is well ventilated to remove the smoke and smell. Avoid directly inhaling the smoke and the smell that emits.

How to use the hob

General information about cooking

Never fill the pan with oil more than one third of it. Do not leave the hob unattended when heating oil. Overheated oils bring risk of fire. Never attempt to extinguish a possible fire with water! When

oil catches fire, cover it with a fire blanket or damp cloth. Turn off the hob if it is safe to do so and call the fire department.

- Before frying foods, always dry them well and gently place into the hot oil. Ensure complete thawing of frozen foods before frying.
- Do not cover the vessel you use when heating oil.
- Place the pans and saucepans in a manner so that their handles are not over the hob to prevent heating of the handles. Do not place unbalanced and easily tilting vessels on the hob.
- Do not place empty vessels and saucepans on cooking zones that are switched on. They might get damaged.
- Operating a cooking zone without a vessel or saucepan on it will cause damage to the product. Turn off the cooking zones after the cooking is complete.
- As the surface of the product can be hot, do not put plastic and aluminum vessels on it. Clean any melted such materials on the surface immediately. Such vessels should not be used to keep foods either.
- Use flat bottomed saucepans or vessels only.
- Put appropriate amount of food in saucepans and pans. Thus, you will not have to make any unnecessary cleaning by preventing the dishes from overflowing. Do not put covers of saucepans or pans on cooking zones. Place the saucepans in a manner so that they are centered on the cooking zone. When you want to move the saucepan onto another cooking zone, lift and place it onto the cooking zone you want instead of sliding it.

Saucepan selection

- Glass ceramic surface is heatproof and is not affected by big temperature differences.
- Do not use the glass ceramic surface as a place of storage or as a cutting board.
- Use only the saucepans and pans with machined bottoms. Sharp edges create scratches on the surface.

Spills may damage the glass ceramic surface and cause fire.

Do not use vessels with concave or convex bottoms.

Use only the saucepans and pans with flat bottoms. They ensure easier heat transfer.

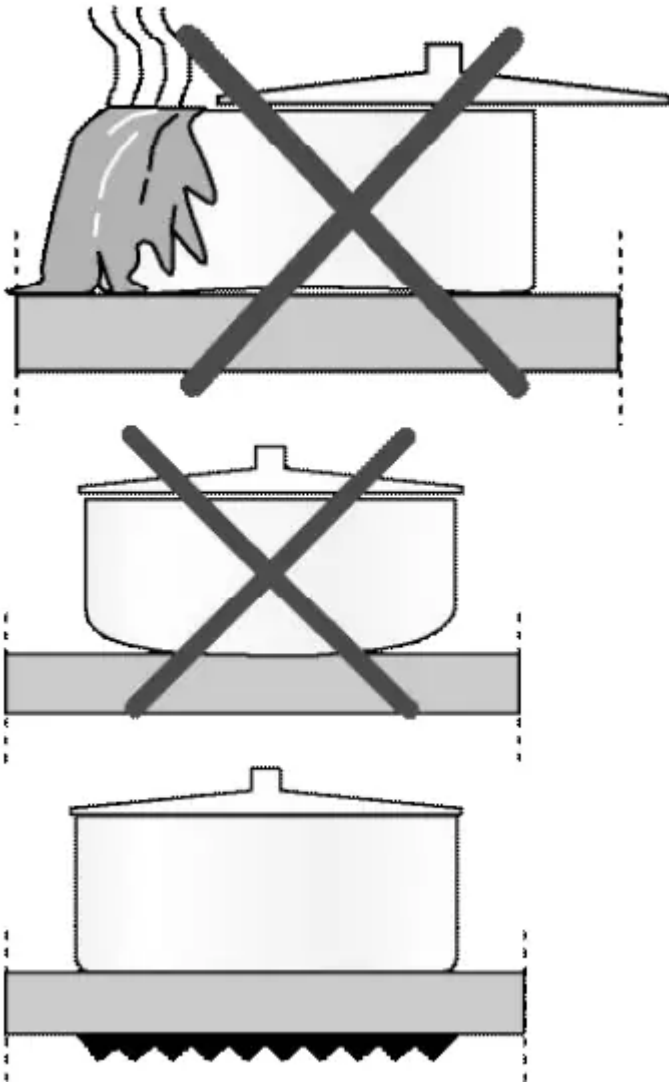

For induction hobs, use only vessels suitable for induction cooking.

Saucepan test

Use following methods to test whether your saucepan is compatible with the induction hob or not.

1. Your saucepan is compatible if its bottom holds magnet.



2. Your saucepan is compatible if  does not flash when you place your saucepan on cooking zone and start the hob.

You can use steel, teflon or aluminium saucepans with special magnetic bottom that contains labels or warnings indicating that the saucepan is compatible with induction cooking. Glass and ceramic vessels, pots and the stainless steel vessels with non-magnetic aluminium bottom should not be used.

Saucepan recognition-focusing system

In induction cooking, only the area covered by the vessel on the relevant cooking zone is energised. The vessel's bottom is recognised by the system and only this area is heated automatically. Cooking stops if the cooking vessel is lifted from the cooking zone during cooking.



Selected cooking zone and "  " symbol flashes alternately.

Safe use

Do not select high heating levels when you will use a non-sticking (teflon) saucepan with no oil or with very little oil.

Do not put metal items such as forks, knives or saucepan covers onto your hob since they can get heated. Never use aluminium foil for cooking. Never place food items wrapped with aluminium foil onto the cooking zone.

If there is an oven under your hob and if it is running, sensors of the hob can decrease the cooking level or turn off the oven. When the hob is running, keep items with magnetic properties such as credit cards or cassettes away from the hob.

Selecting cooking zone suitable to the vessel

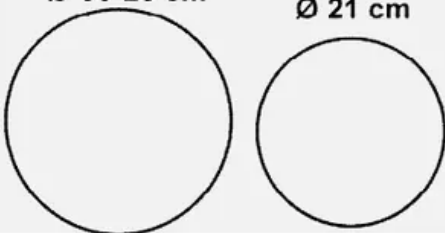
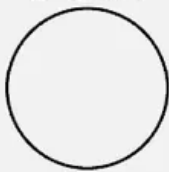
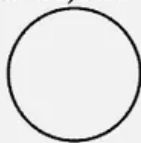
Large cooking zone	Normal cooking zone	Small cooking zone
<p>Ø 30-28 cm Ø 21 cm</p> 	<p>Ø 18 cm</p> 	<p>Ø 14,5 cm</p> 
<p>Large cooking zone</p> <ul style="list-style-type: none"> Automatically fits to the saucepan. Distributes the power ideally. Provides perfect heat distribution. Used to cook dishes such as large meals. 	<p>Normal cooking zone</p> <ul style="list-style-type: none"> Automatically fits to the saucepan. Distributes the power ideally. Provides perfect heat distribution. Used for all kinds of meals. 	<p>Small cooking zone</p> <ul style="list-style-type: none"> Used for slow cooking (sauces, creams) Used to prepare small portions or portions based on number of persons.

Using pots on the wide surface cooking zone

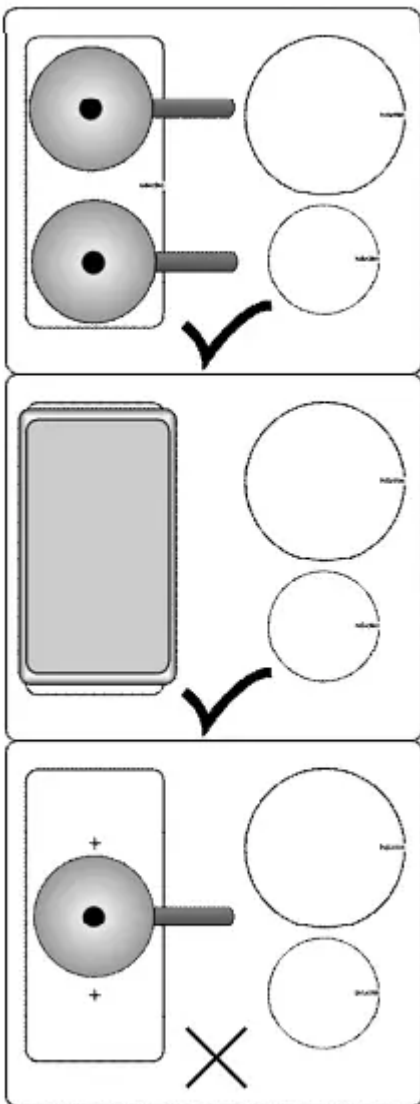

You can use the wide surface cooking zone in two halves separately as rear left and front left cooking zones.

You can use the wide surface cooking zone for large pots.

Your pot must cover both centers of the wide surface cooking zone. Do not use the cooking zone in other ways.

Using the hobs

DANGER: Do not allow any object to drop on the hob. Even small objects such as a saltshaker may damage the hob. Do not use cracked hobs. Water may leak through these cracks and cause short circuit. In case of any kind of damage on the surface (eg., visible cracks), switch off the product immediately to minimize the risk of electric shock.

Control panel



Specifications



Light indicating that the relevant key is functioning



On / Off key



Keylock key



Timer Activation / Deactivation key



High power setting (Booster) key



Automatic cooking key



Stop key



Minus key



Plus key



Cooking zone
combination/separation key

Graphics and figures are for informational purposes only. Actual appearances or functions may vary according to the model of your hob.

Cooking Zone display

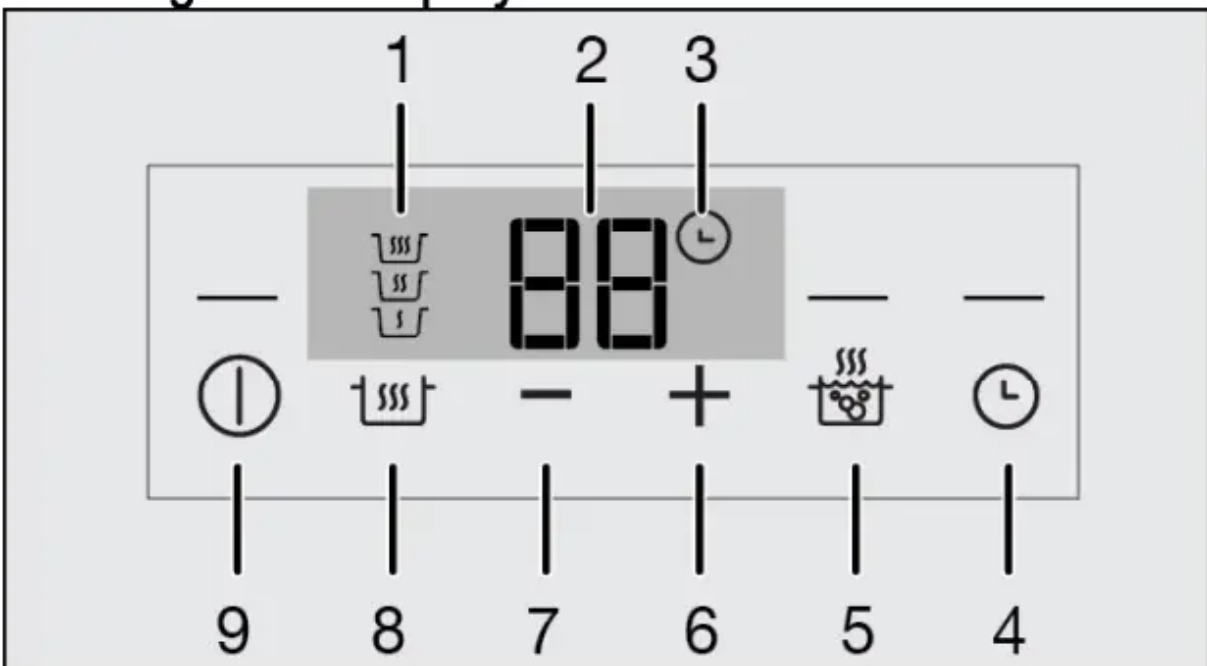

1. Automatic cooking symbols
2. Level/timer indicator
3. Timer symbol
4. Timer activation key
5. High power setting (Booster) activation key
6. Plus key
7. Minus key
8. Automatic cooking key
9. Cooking zone on/off key

This product is controlled by means of a touch control panel. Each operation you make on your touch control panel will be confirmed by an audible signal. Always keep the control panel clean and dry. Having damp and soiled surface may cause problems in the functions.

Switching on the cooking zone:

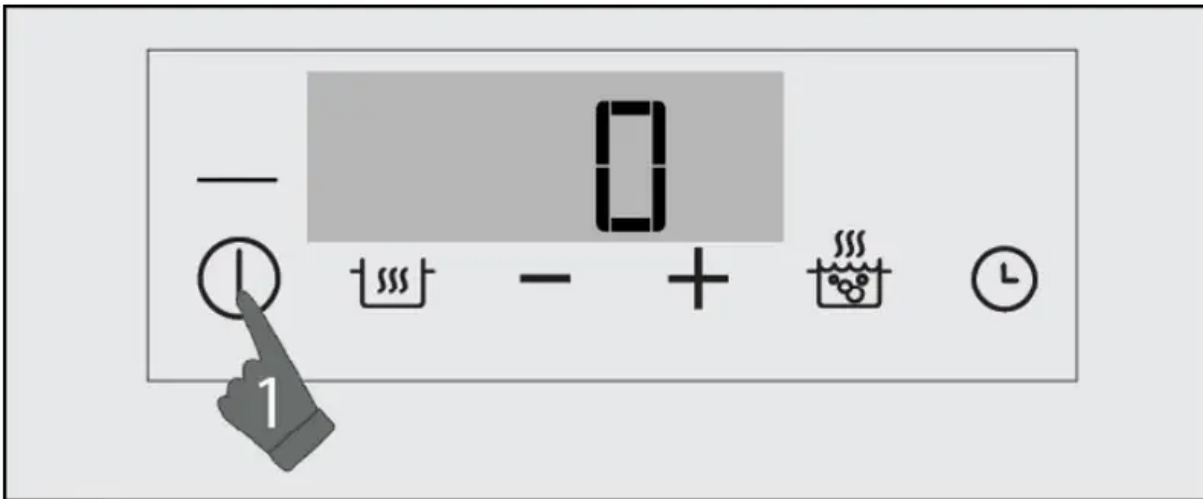

1. On the control panel, touch the "ⓘ" key of the cooking zone you want to switch on. Light of the "ⓘ" key will turn on and "0" appears on the cooking zone display. Cooking zone is ready for use.



The hob will automatically return to Standby mode if no operation is performed within 10 seconds..
The product will switch itself off for safety reasons if no key is touched for a long time.

Switching off the cooking zone:

An active cooking zone can be switched off in 3 different ways:

1. By touching the "  " key of the relevant cooking zone; Touch the "  " key of the cooking zone you want to switch off
2. By dropping the temperature to "0" level; You can switch off the cooking zone by adjusting the temperature setting to "0" level.
3. By using the switching off function on the timer for the desired cooking zone; When the time is over, the timer will switch off the cooking zone linked to it. "0" or "00" value will appear on all

displays. The "  " symbol on the hob indicator display will disappear.

When the time is over, an audible alarm will sound. Touch any key on the control panel to silence the audible alarm.

If "H" or "h" is on after the cooking zone has been switched off, it means that the cooking zone is still hot. Do not touch the cooking zones..

Residual heat indicator

If "H" symbol is flashing on the cooking zone display, it means that the hob is still hot and can be used to keep a small amount of food warm. The symbol will soon turn to "h" symbol, which means it is less hot.

When the electricity is cut off, residual heat indicator will not light up and does not warn the user against hot cooking zones.

Adjusting the temperature level

1. Switch off the cooking zone you desire by touching its "⏻" key.

2. Adjust the desired temperature level by touching the "—"/"⊕" keys.

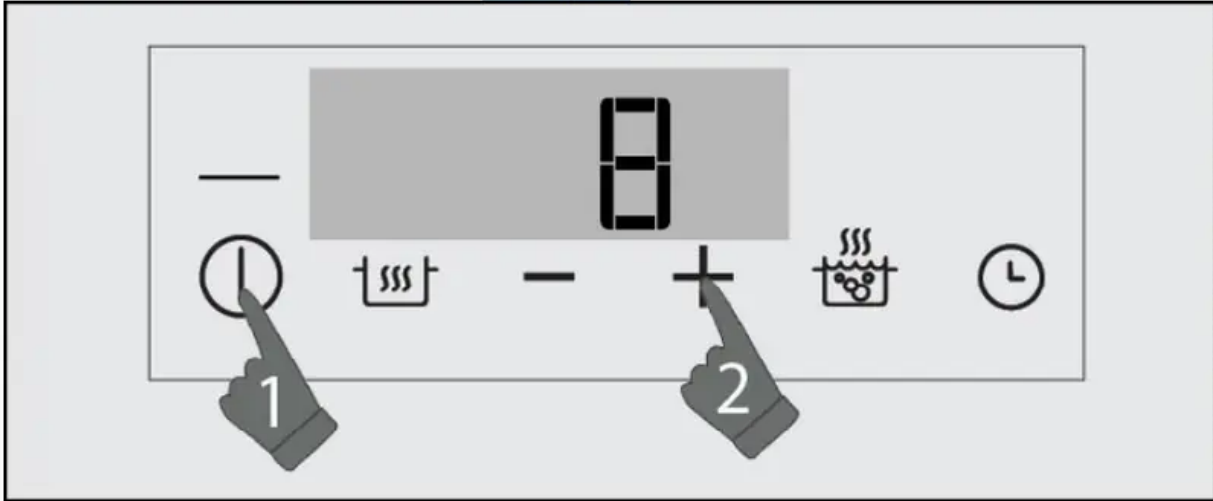

» The relevant cooking zone will start to operate at the set temperature level.

Turning on the wide surface cooking zone

1. Switch on the cooking zone you desire by touching its "⏻" key.

2. Touch Wide Surface Cooking Zone Selection key.

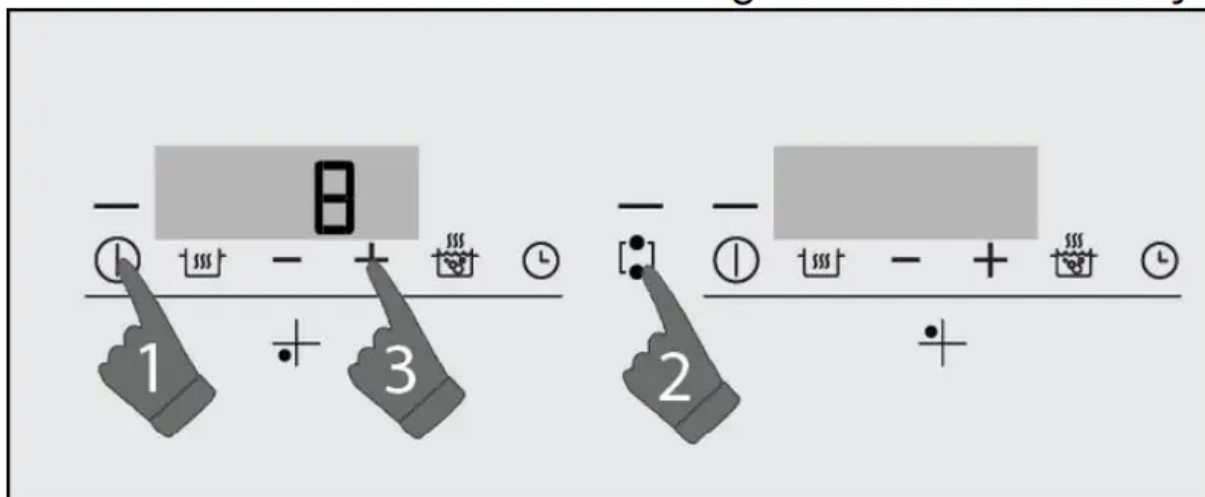

» The lights of the Wide Surface Cooking Zone Selection key and the both "⏻" keys illuminates continuously.

3. Adjust the desired temperature level by touching the " — / + " keys of the front left cooking zone display.

» Cooking zone starts to run. If another cooking zone is selected or no operation is performed for 10 seconds, the light of the wide surface cooking zone illuminates continuously.

Turning on the wide surface cooking zone while one or both of the left cooking zones are running

While one or both of the left cooking zones are running, you can combine both cooking zones by activating the wide surface cooking zone. Thus, you can utilize a wider cooking zone just with the same values.

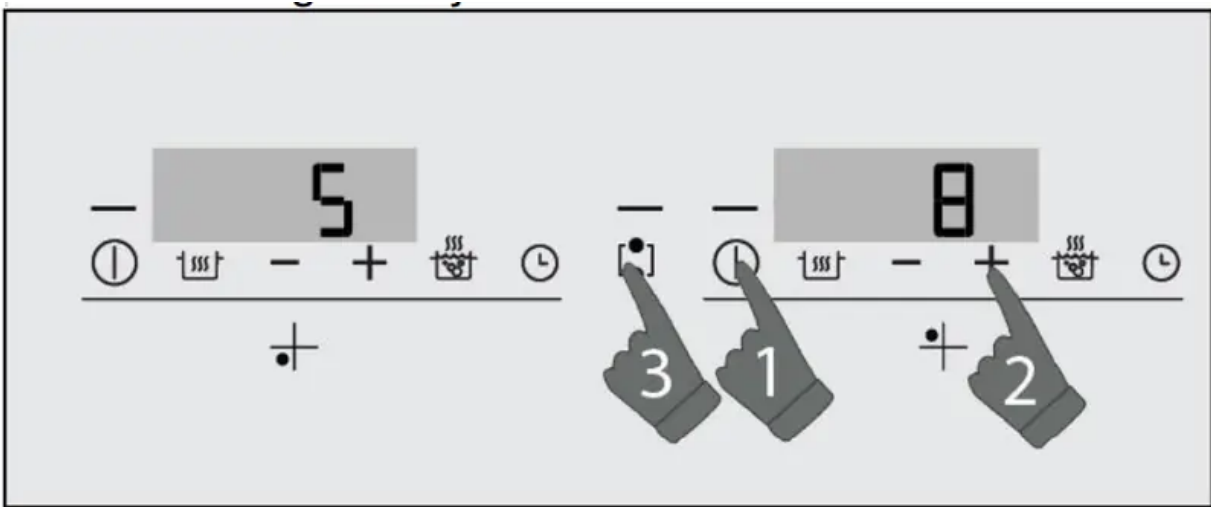

1. Switch on the other cooking zone by touching its " 1 " key.
2. Select one of the left cooking zones while one or both of the left cooking zones are running.
3. Touch Wide Surface Cooking Zone Selection key.

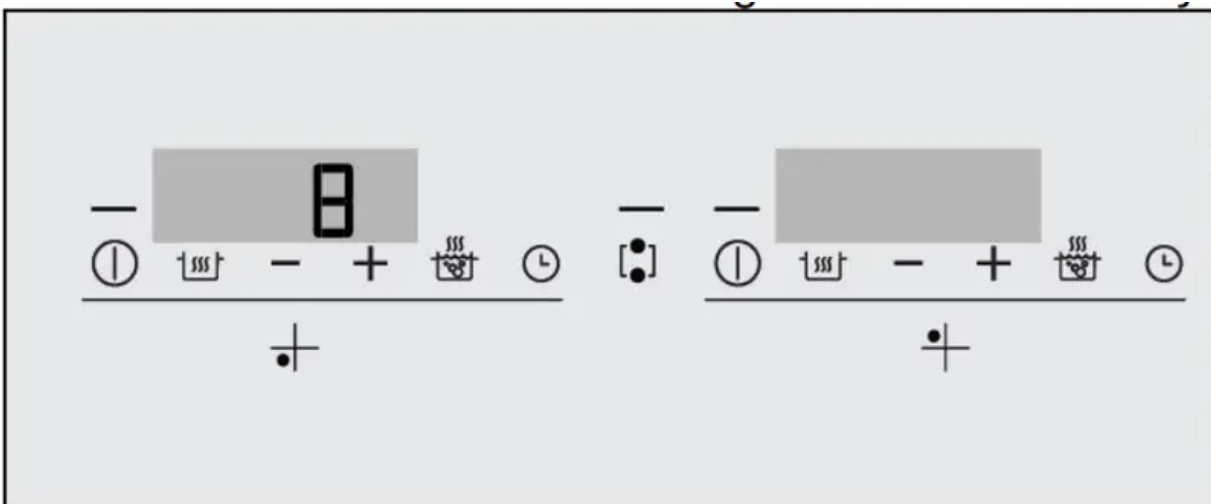



» Temperature value of the last set cooking zone appears on the front left cooking zone display.

The lights of the Wide Surface Cooking Zone Selection key and the both "  "keys illuminates continuously.

» Combined cooking zones continue operating with the temperature and the timer (if available) value of the left cooking zone you last set. Value of the left cooking zone which was first set zones is canceled.

If you touch any of the left cooking zone selection keys while the wide surface cooking zone is active, cooking zones are separated and turned off.

» **To change the temperature value at a later stage, adjust the desired temperature level by**

touching the"  " / "  " keys of the front left cooking zone display.

Turning off the wide surface cooking zone

Wide surface cooking zone can be turned off in 4 different ways:

1. By dropping the temperature level to "0". You can turn the wide surface cooking zone off by dropping the temperature level to "0".

2. By using the turn-off with the timer option for the wide surface cooking zone.

When the time is over, the timer will turn off the wide surface cooking zone. "0" will appear on the

left cooking zone display and "00" will appear on the timer display. The "  " symbol and the light of the timer key on the front left cooking zone display will disappear.

3. By touching the " " keys of any of the left cooking zones.

If you touch "  " key of any of the left cooking zones while the wide surface cooking zone is active, the cooking zones are separated and turned off. The cooking zone which is not turn of, it will be continue with set levels.



4. By touching the wide surface cooking zone symbol.

If you touch the wide surface cooking zone symbol, the cooking zone is turned to "0" level separately. If it is not set to any level, the cooking zone turn off automatically within 10 second.

High power setting (BOOSTER)

You can use booster function for rapid heating. However, this function is not recommended for cooking a long time. Booster function may not be available in all cooking zones.

Selecting the high power setting (BOOSTER):

1. Switch on the cooking zone you desire by touching its "  " key.
2. Touch the "  " key.

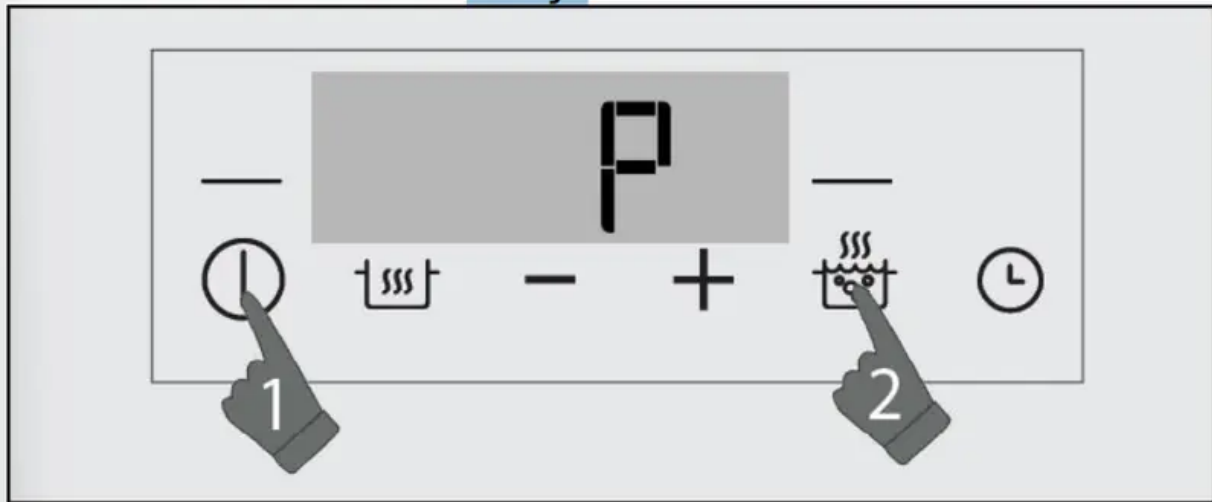

» Selected cooking zone will operate with maximum power and "P" symbol will appear on the cooking zone display. Cooking zone will switch itself off when the booster time is up

Switching off the high power setting (BOOSTER) prematurely: You can switch off the high

power setting anytime you want by touching the "  " key.

Working principle of 2 zones which are located same vertical direction:

If one zone is set to level booster and than the other zone, which is located same vertical direction set to bigger than level 6 (7, 8 and 9), first zone drops to level 9 and the other zone can be set bigger than level 6 (7, 8 and 9). If the second zone is set to level booster, first zone drops to level 6.

Cleaning lock

The cleaning lock prevents operation of all keys on the control panel for 20 seconds while the hob is switched on to allow the user to make a short cleaning. Product will not draw any power throughout this time.

Activating the cleaning lock

1. Touch and hold the "  " key until a single signal sound is heard when any cooking zone is switched on. The key lock light will blink and a countdown begins from 20 on the display of the



active cooking zones. None of the keys on the panel will function except the "  " key throughout this period.

Deactivating the cleaning lock

You do not have to press any key to deactivate the cleaning lock. The hob will give a signal audio signal after 20 seconds, key lock light will go off and the cleaning lock will automatically be deactivated.

If any key is pressed when the child lock function is active, an audible signal will be heard and the



light of the "  " key will blink.

Child Lock

When the cooking zones are switched off, you can protect the hob with the child lock to prevent children from switching on the cooking zones. You can activate or deactivate the child lock only when the cooking zones are switched off (in the standby mode).

Activating the child lock



1. Touch and hold the "  " key until a single signal sound is heard when the hob is in the

standby mode. The child lock will be activated and the light of the "  " key will be turned on.

If any key is pressed when the child lock function is active, an audible signal will be heard and the



light of the "  " key will blink.

Deactivating the child lock





1. Touch the "  " key until a single signal sound is heard when the child lock is active.



» The child lock function will be deactivated and the light of the "  " key goes out after blinking twice.

Key Lock



You can activate the key lock in order to prevent the functions from being changed by mistake while the hob is operating.

Activating the key lock

1. Touch and hold the " " key for a long time while any of the cooking zones is active. Only one signal sound will be heard first. In this case, your hob is switched to cleaning lock. Then, keep on touching without lifting your finger until you hear two successive signal sounds. The light of the " " key will flash and all cooking zones will be locked.

You can activate the key lock in the operation mode only. Only the " " key will be functional when the key lock is active. When you touch any other button, the light of the " " key will blink to indicate that the key lock is active. If you switch the hob off when the keys are locked, you must deactivate the key lock in order to be able to switch on the hob again.



Deactivating the key lock

1. Touch the " " key for about 2 seconds. The operation will be confirmed with an audible signal. The light of the " " key will go out and the control panel will get unlocked.



Timer function

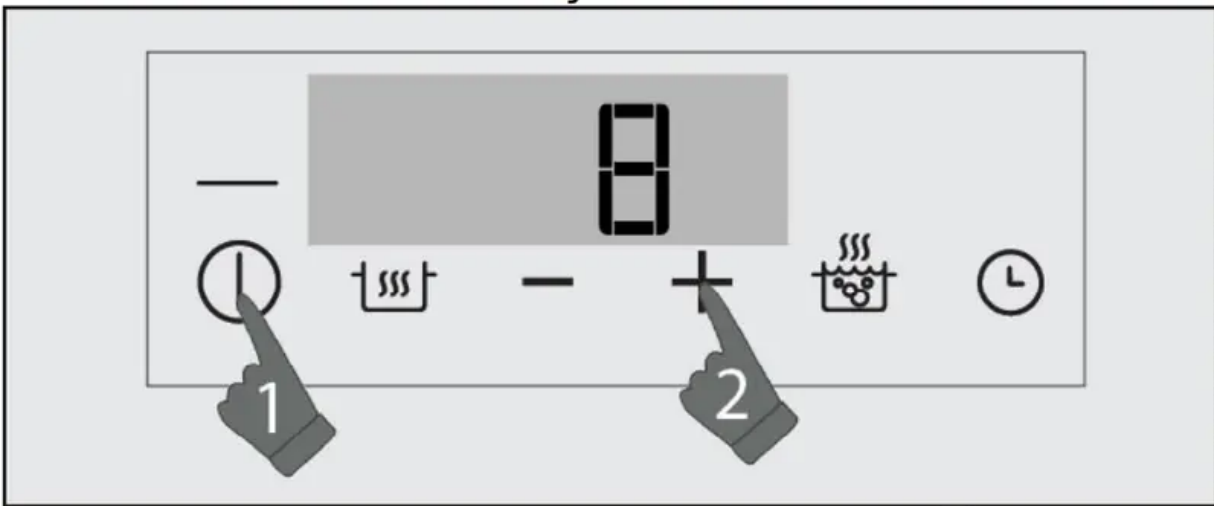

This function makes it easier for you to cook. You will not have to watch the hob for the whole cooking period. The cooking zone will be switched off automatically at the end of the time period you have set.

Activating the timer

1. Switch on the cooking zone you desire by touching its " " key.
2. Adjust the desired temperature level by touching the " " keys.



3. Activate the timer by touching the "  " key. "00" and "  " symbols will light on the cooking zone display.

4. Set the desired duration by touching the "  " / "  " keys.

5. Touch the "  " key again to confirm the setting. The setting will be activated unless you touch the key again within 10 seconds.

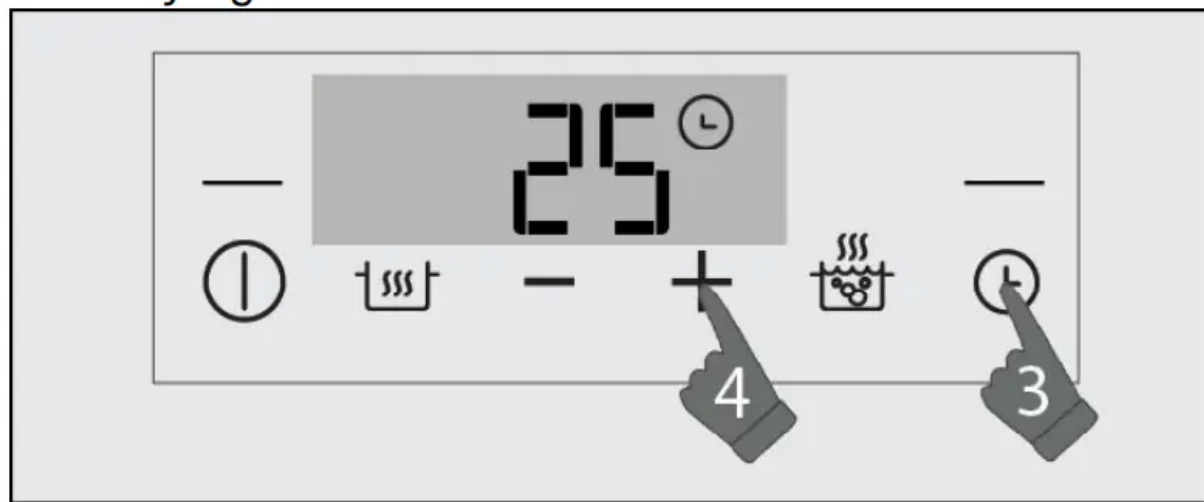

The timer can only be set for the operating cooking zones. In order to set the timers of the other cooking zones, repeat the process explained above. Timer cannot be set without selecting the cooking zone and its temperature value. You can see the remaining cooking time by touching the

"  " key of the relevant cooking zone again.



Deactivating the timer

Once the set time is over, the hob will be switched off automatically and give an audible warning. Press any key to silence the audio warning.

Deactivating the timers earlier

If you deactivate the timer earlier, the hob will keep on operating at the set temperature until it is switched off. You can deactivate the timer earlier in two different ways:

Deactivating the timer by dropping its value to "00":

1. Touch the " / "  S " keys until "00" appears on the display of the cooking zone whose timer is active.

» " " symbol will permanently goes off on the cooking zone display and the timer will get canceled. 2-Deactivating the timer by touching its key for about 3 seconds:

1. Touch the " " key of the cooking zone whose timer is active for about 3 seconds. »



" " symbol will permanently goes off on the cooking zone display and the timer will get canceled.

Automatic cooking function

You can cook quickly at 3 different levels by means of this function.

1. Keeping warm
2. Simmering
3. Frying

Activating the automatic cooking function without setting the timer

1. Switch on the cooking zone you desire by touching its " " key.
2. Touch the " " key of the cooking zone on which you want to activate the automatic cooking function.

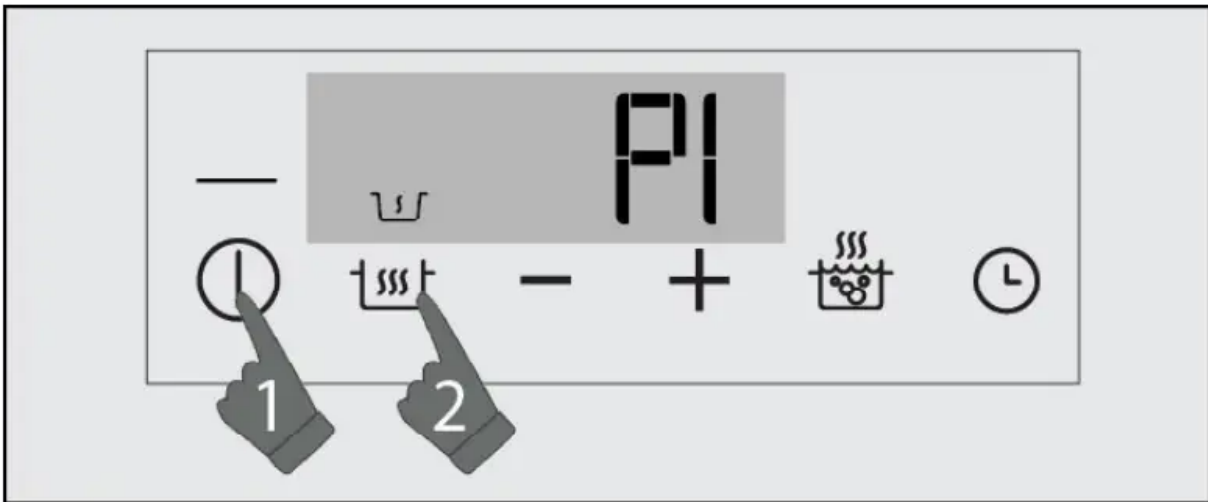

3. The relevant cooking zone will be activated at the keeping warm level after the first touch. "P1" and "P1" symbols will appear on the display.

4. The relevant cooking zone will be activated at the simmering level after the second touch. "P2" and "P2" symbols will appear on the display.

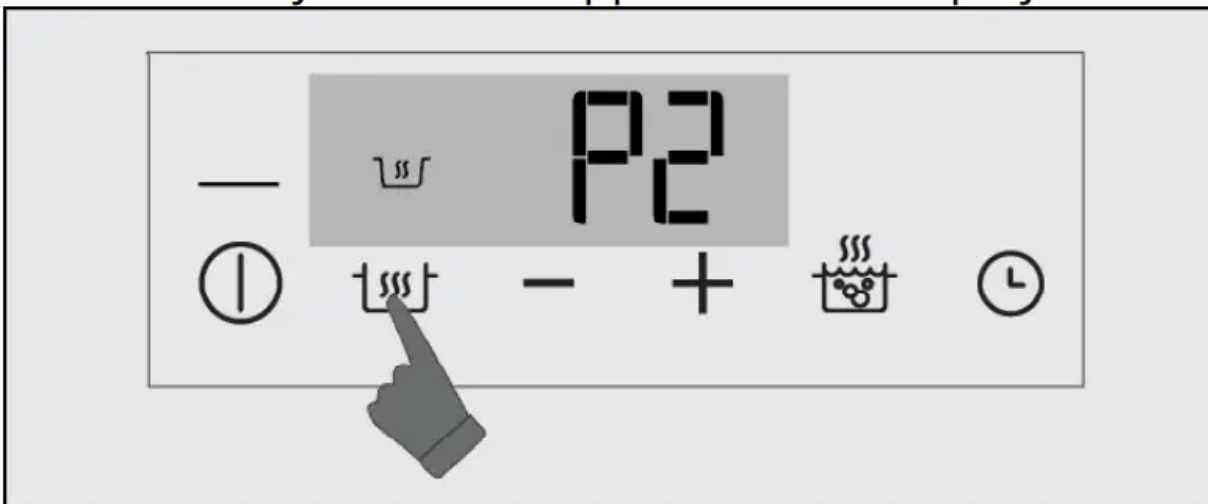

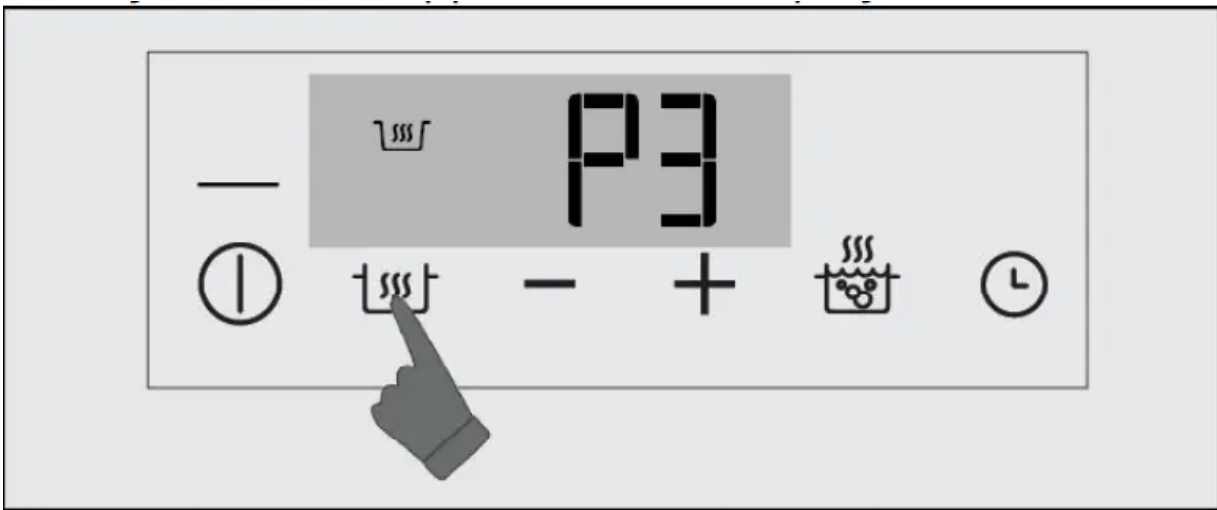

5. relevant cooking zone will be activated at the frying level after the third touch. "P3" and "P3" symbols will appear on the display.





» The cooking zone will start to operate at the set automatic cooking level.

Activating the automatic cooking function by setting the timer

1. Select the desired automatic cooking level by touching the "  " key of the relevant cooking zone.

2. Activate the timer by touching the "  " key.

» "00" and "  " symbols will light on the display.

3. Set the desired duration by touching the "  " levels.

» The cooking zone will keep on operating at the selected automatic cooking level throughout the set time period.

» Once the set time is over, the hob will be switched off automatically and give an audible warning. Press any key to silence the audio warning.

Deactivating the automatic cooking function

1. You can completely switch off the relevant cooking zone by touching the "  " key to cancel the automatic cooking function.

2. If you want the cooking zone to operate at a certain level and deactivate the automatic cooking

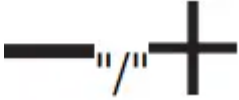
function, set the desired temperature level by touching the "  " keys. The cooking

zone will keep on operating at the set temperature level. If the timer has been set previously, the set cooking time will not be canceled and will keep on at the set temperature level.

Stop function

You can stop all functions (except for the timer) operating on the hob by means of this function.

If the timer is set for any cooking zone, it will continue operating during stoppage.



1. Touch the "  " key when any of the cooking zones is operating. All operating cooking zones

will stop. "  " symbol will appear on the display of the active cooking zones.



2. Touch the "  " key again to reactivate all the stopped cooking zones with their previous settings.

Using the induction cooking zones safely and effectively

Operating principles: Induction hob directly heats the cooking vessel as a matter of principle.

Therefore, it has a lot of advantages as compared with other hob types. It operates more efficiently and the hob surface is colder. Your induction hob is equipped with superior safety systems that will provide you maximum safe usage.

Your hob can be equipped with induction cooking zones with a diameter of 145, 180, 210 and 280 mm depending on the model. Each cooking zone automatically detects the vessel placed on it thanks to the induction feature. Energy is generated only where the vessel comes into contact with the cooking zone and thus, minimum energy consumption is achieved.

Operation time limits

The hob control is equipped with an operation time limit. If one or more cooking zones are left on, the cooking zone will automatically be deactivated after a certain period of time (see, Table-1). If there is a timer assigned to the cooking zone, the timer display will also turn off later.

Operation time limit depends on the selected temperature level. Maximum operation time is applied at this temperature level. The cooking zone may be reactivated by the user after it is switched off automatically as described above.

Table-1: Operation time limits

Temperature level	Operation time limit - hour
0	0
1	6
2	6
3	5
4	5
5	4
6	1,5
7	1,5
8	1,5
9	0,5
Rapid Heating (P)	10 minutes
P1	6
P2	4
P3	1,5

Overheating protection

Your hob is equipped with some sensors which provide protection against overheating. Following may be observed in case of overheating:

- Operating cooking zone may get switched off.
- Selected level may drop to level 7 from higher level.

Overflow safety system

Your hob is equipped with an overflow safety system. If there is any overflow that spills onto the control panel, the system will cut the power connection immediately and switch off your hob. "E" warning appears on the indicator during this period.

Precise power setting

Induction hob reacts to commands immediately as an operating principle. It changes the power settings very fast. Thus, you can prevent a cooking pot (containing water, milk and etc.) from overflowing even if it was just about to overflow.

Noisy operation

Some sounds may come from the induction hob. These sounds are normal and a part of induction cooking.

- The sound becomes prominent at high temperature levels.
- Alloy of the cooking pot can cause noise.
- A regular on/off sound arising from the operating principle can be heard at low levels.
- Noise can be heard if an empty cooking pot is heated. When you put water or food in it, this sound will go away.
- The noise of the fan that cools the electronic system can be heard.

Error messages

Table-2: Error codes and error causes

Error cause	Indicator	Display
Two or more keys are pressed	The "E" symbol blinks	Cooking zone display
Hob is overheated	The "H" symbol blinks	Cooking zone display

For further information about error messages that may appear on the touch control panel, see Table-2. If the surface of the touch control panel is exposed to intense vapour, the entire control system may become deactivated and give error signal. Keep the surface of the touch control panel clean. Erroneous operation may be observed.

Maintenance and care

General information

Service life of the product will extend and the possibility of problems will decrease if the product is cleaned at regular intervals.

DANGER: Disconnect the product from mains supply before starting maintenance and cleaning works. There is the risk of electric shock!

DANGER: Allow the product to cool down before you clean it. Hot surfaces may cause burns!

- Clean the product thoroughly after each use. In this way it will be possible to remove cooking residues more easily, thus avoiding these from burning the next time the appliance is used.
- No special cleaning agents are required for cleaning the product. Use warm water with washing liquid, a soft cloth or sponge to clean the product and wipe it with a dry cloth.
- Always ensure any excess liquid is thoroughly wiped off after cleaning and any spillage is immediately wiped dry.
- Do not use cleaning agents that contain acid or chloride to clean the cooktop. Use a soft cloth with a liquid detergent (not abrasive) to wipe those parts clean, paying attention to sweep in one direction.

The surface might get damaged by some detergents or cleaning materials. Do not use aggressive detergents, cleaning powders/creams or any sharp objects during cleaning. Do not use harsh abrasive cleaners or sharp metal scrapers to clean the cooking surface since they can scratch the surface.

Do not use steam cleaners to clean the appliance as this may cause an electric shock.

Cleaning the hob

Glass ceramic surfaces

Wipe the glass ceramic surface using a piece of cloth dampened with cold water in a manner as not to leave any cleaning agent on it. Dry with a soft and dry cloth. Residues may cause damage on the glass ceramic surface when using the hob for the next time.

Dried residues on the glass ceramic surface should under no circumstances be scraped with hook blades, steel wool or similar tools.

Remove calcium stains (yellow stains) by a small amount of lime remover such as vinegar or lemon juice. You can also use suitable commercially available products.

If the surface is heavily soiled, apply the cleaning agent on a sponge and wait until it is absorbed well. Then, clean the surface of the hob with a damp cloth.

Sugar-based foods such as thick cream and syrup must be cleaned promptly without waiting the surface to cool down. Otherwise, glass ceramic surface may be damaged permanently

Slight color fading may occur on coatings or other surfaces in time. This will not affect operation of the product. Color fading and stains on the glass ceramic surface is a normal condition, and not a defect.

Troubleshooting

Water drops occur during cooking.

- The vapour that arises during cooking can condense and form water droplets when it hits cold surfaces of the product. >>> This is not a fault.

Product emits metal noises while heating and cooling.

- When the metal parts are heated, they may expand and cause noise. >>> This is not a fault.

Product does not operate.

- The mains fuse is defective or has tripped. >>> Check fuses in the fuse box. If necessary, replace or reset them.
- Product is not plugged into the (grounded) socket. >>> Check the plug connection.
- If the display does not light up when you switch the hob on again. >>> Disconnect the appliance at the circuit breaker. Wait 20 seconds and then reconnect it.
- Overheat protection is active. >>> Allow your hob to cool down.
- The cooking pot is not suitable. >>> Check your pot.

" " symbol appears on the cooking zone display.

- You have not placed the pot on the active cooking zone. >>> Check if there is a pot on the cooking zone.
- Your pot is not compatible with induction cooking. >>> Check if your cooking pot is compatible with induction hob.
- The cooking pot is not centered properly or the bottom surface of the pot is not wide enough for the cooking zone. >>> Choose a pot wide enough and center the pot on the cooking zone properly.
- Cooking pot or cooking zone is overheated. >>> Allow them to cool down.

Selected cooking zone suddenly turns off during operation.

- Cooking time for the selected cooking zone may be over. >>> You may set a new cooking time or finish cooking.
- Overheat protection is active. >>> Allow your hob to cool down.
- An object may be covering the touch control panel. >>> Remove the object on the panel.

The pot does not get warm even if the cooking zone is on.

- Your pot is not compatible with induction cooking. >>> Check if your cooking pot is compatible with induction hob.

- The cooking pot is not centered properly or the bottom surface of the pot is not wide enough for the cooking zone. >>> Choose a pot wide enough and center the pot on the cooking zone properly.

Cooling fan continues operating although the hob is turned off.

- This is not a fault. Cooling fan will continue operating until the electronics in the hob cools down to a suitable temperature.

Consult the Authorised Service Agent or technician with licence or the dealer where you have purchased the product if you can not remedy the trouble although you have implemented the instructions in this section. Never attempt to repair a defective product yourself.

Warning

This content is compiled from multiple sources and is provided for reference purposes only. It may not be complete or fully applicable to all situations. If you are unable to resolve your issue, please contact the product manufacturer or an authorized service provider for official support.