

## PARTS AND FEATURES

This manual covers different models. The oven you have purchased may have some or all of the items listed. The locations and appearances of the features shown here may not match those of your model.

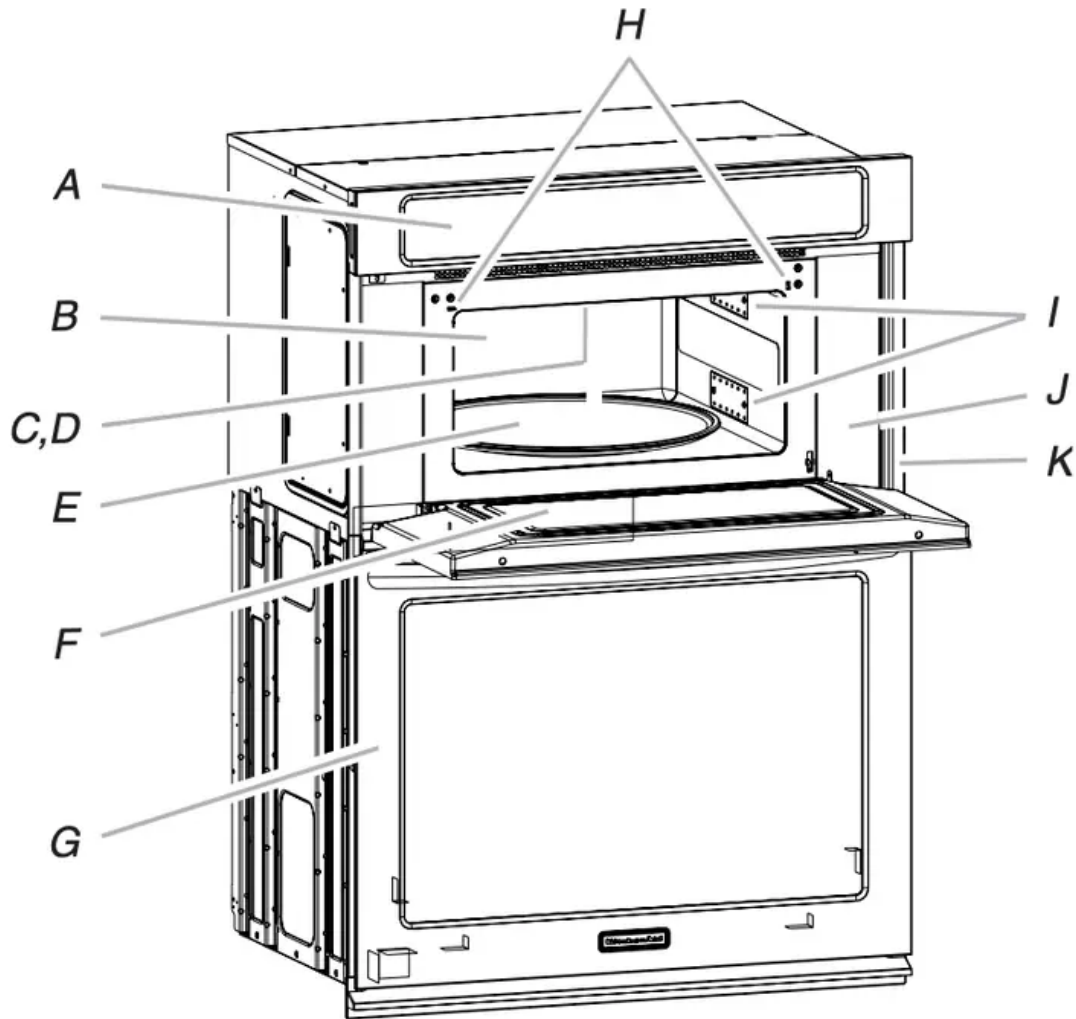

- A. *Electronic oven control*
- B. *Convection element and fan (hidden behind back panel)*
- C. *Light (inaccessible, in ceiling)*
- D. *Grill element (can be lowered)*
- E. *Turntable*
- F. *Metal shielded window*
- G. *Lower oven (on combination models, see separate User Guide)*
- H. *Door safety lock system*

*I. Dual microwave emission*

*J. Cooking guide label*

*K. Model/serial/rating (on right mounting rail, single oven models)*

**Parts and Features not shown**

*Steamer*

*Convection grid*

*Crisper pan and handle*

*Baking tray*

**Turntable**

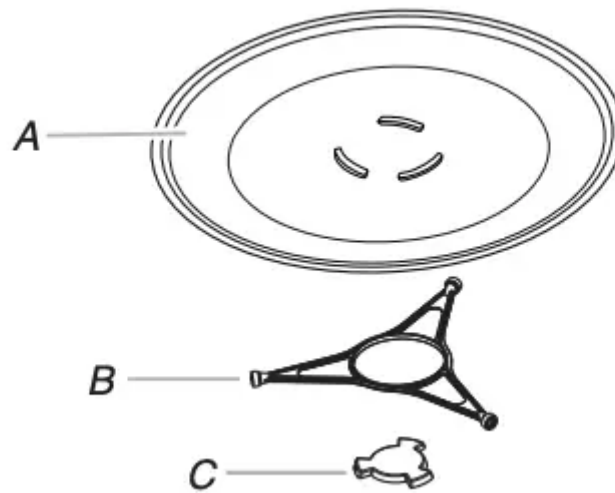

*A. Turntable*

*B. Support and rollers*

*C. Hub*

**NOTE:** By touching the Turntable ON/OFF key, it is possible to switch the turntable ON and OFF during some microwave cycles. The turntable can be turned “On” or “Off” during the Manual Cook, Manual Reheat, Manual Defrost, Manual Steam Cook, and all Easy Convection cycles.

The turntable rotates in both directions to help cook food more evenly. Do not operate the microwave oven without having the turntable in place. See “Assistance or Service” to reorder any of the parts.

The raised, curved lines in the center of the turntable bottom fit between the 3 spokes of the hub. The hub turns the turntable during microwave oven use. The rollers on the support should fit inside the turntable bottom ridge.

## Convection Rack

The convection rack provides optimal heat circulation for convection cooking.

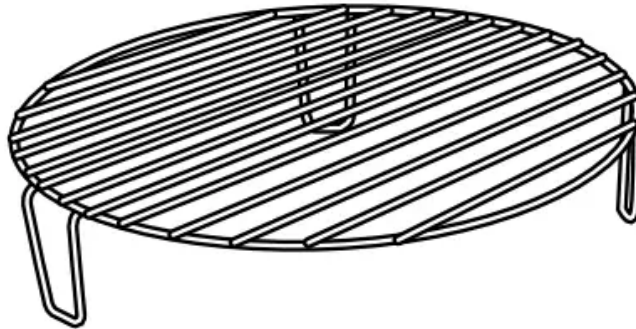

- The rack will become hot. Always use oven mitts or pot holders when handling.
- To avoid damage to the microwave oven, do not allow the rack to touch the inside cavity walls, ceiling or floor.
- Always use the turntable.
- To avoid damage to the microwave oven, do not store the rack in the microwave oven.
- Two-level cooking is not recommended.
- For best results, do not place popcorn bags on the rack.
- The rack is designed specifically for this microwave oven. For best cooking results, do not attempt to use any other rack in this microwave oven.
- See “Assistance or Service” section to reorder.

## Crisper Pan and Handle

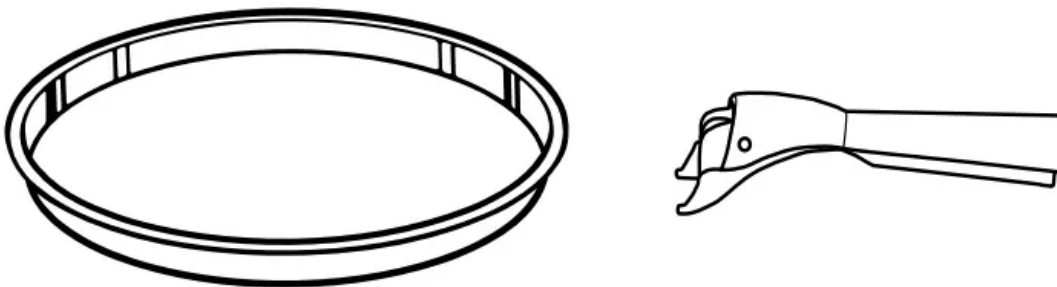

The crisper pan, with its nonstick surface and detachable handle, has been specifically designed for microwave use, and is ideal for pan-frying (pan-browning) foods in the microwave oven.

- The crisper pan will become hot. Always use the handle and oven mitts or pot holders when handling. Place gripping end on the edge of pan, squeeze handle, and lift pan.

- To avoid damage to the microwave oven, do not allow the crisper pan or handle to touch the inside cavity walls, ceiling or floor.
- Do not place crisper pan on the convection grid. Always use the turntable as a support for the crisper pan.
- To avoid damage to the microwave oven, do not use another metal object with the crisper pan.
- To avoid damage, do not place hot crisper pan directly on heatsensitive surfaces.
- The crisper pan is designed specifically for this microwave oven. Do not use it in any other oven.
- Use only wooden or plastic cooking utensils to help avoid scratches.
- See “Assistance or Service” section to reorder.

## Baking Tray

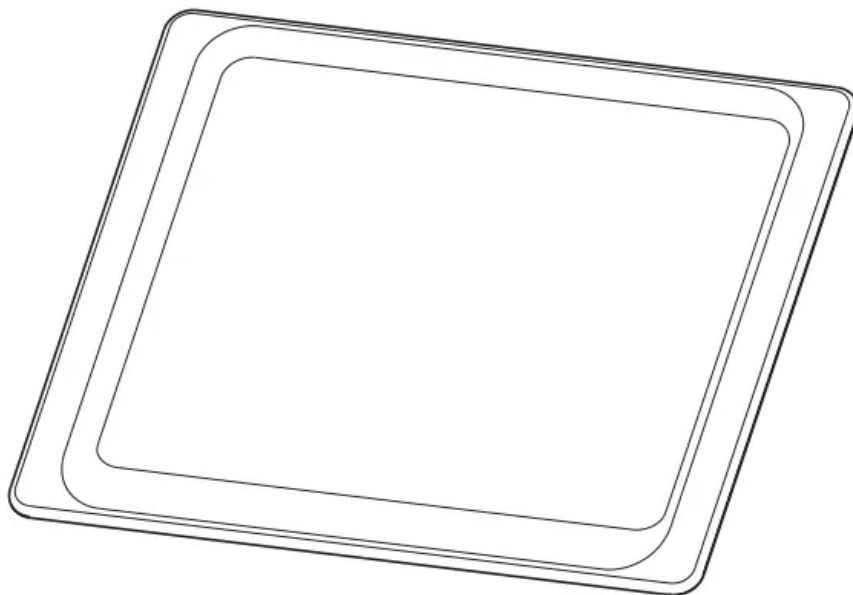

- Baking Tray can be used only with convection cooking.
- To avoid damage to the microwave oven, do not use in combination with microwave cooking.
- Baking Tray will become hot. Always use oven mitts or pot holders when handling.
- See “Positioning Baking Tray” section before using.
- See “Assistance or Service” section to reorder.

## KITCHENAID™ Steamer Vessel

Use the KITCHENAID™ Steamer Vessel with the Steam Cook feature to steam foods.

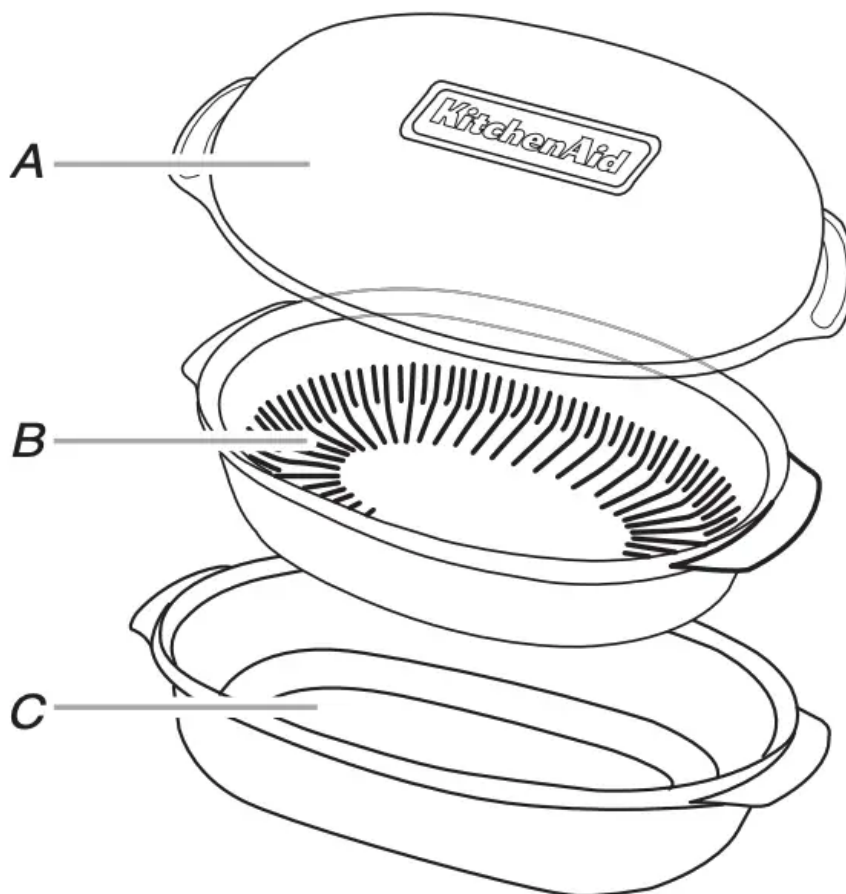

*A. Lid*

*B. Insert*

*C. Base*

- The steamer vessel will become hot. Always use oven mitts or pot holders when handling.
- Steamer vessel is designed to be used only in the microwave oven. To avoid damaging steamer vessel, do not use in a convection- or combination-type oven, with any other convection or crisp function, or on electric or gas burners.
- Do not use plastic wrap or aluminum foil when covering the food.
- Always place the steamer on the glass turntable. Check that the turntable turns freely before starting the microwave oven.
- Do not remove lid while the bowl is inside the microwave oven, as the rush of steam will disrupt the sensor settings.
- To avoid scratching, use plastic utensils.

■ Do not overfill with water. See steam chart in the “Steam Cooking” section for the amount of water recommended.

Lid: Always use the lid when steaming. Place directly over the insert and base or just the base.

Insert: Use when steam cooking to keep foods such as fish and vegetables out of the water. Place insert with food directly over the base. Do not use when simmering.

Base: For steam cooking, place water in base. For simmering foods such as rice, potatoes, pasta and vegetables, place food and water/liquid in base.

See “Assistance or Service” section to order replacements. See “General Cleaning” section for instructions on cleaning.

## FEATURE GUIDE

This manual covers several models. Your model may have some or all of the items listed. Refer to this manual or the Frequently Asked Questions (FAQs) section of our website at [www.kitchenaid.com](http://www.kitchenaid.com) for more detailed instructions. In Canada, refer to the Customer Service Section at [www.kitchenaid.ca](http://www.kitchenaid.ca).

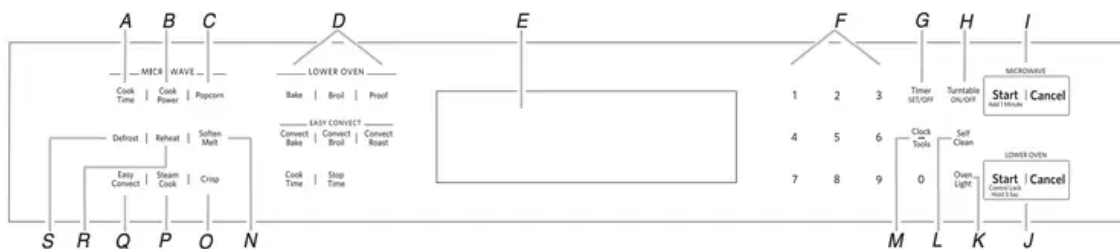

<p>A. Cook Time</p> <p>B. Cook Power</p> <p>C. Popcorn</p> <p>D. Lower Oven Controls (see separate Use and Care Guide).</p> <p>E. Combination Oven Display</p> <p>F. Number Keypads</p>	<p>G. Timer SET/OFF.</p> <p>H. Turntable ON/OFF.</p> <p>I. Start/Cancel Microwave.</p> <p>J. Start/Cancel Lower Oven.</p> <p>K. Oven Light</p> <p>L. Self Clean</p>	<p>M. Clock/Tools.</p> <p>N. Soften Melt.</p> <p>O. Crisp.</p> <p>P. Steam Cook.</p> <p>Q. Easy Convect.</p> <p>R. Reheat.</p> <p>S. Defrost</p>
---	---	--

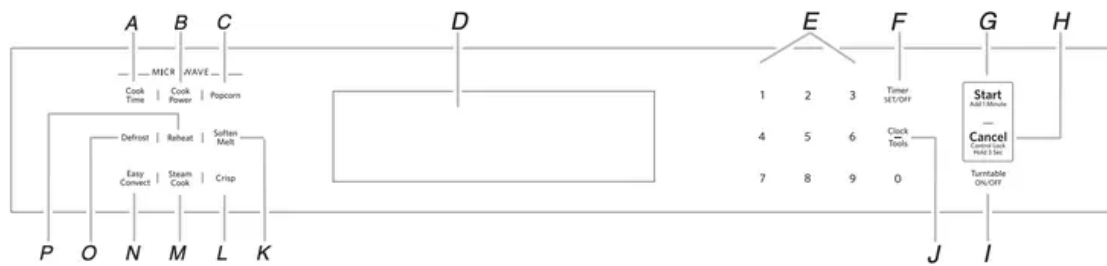

A. Cook Time	G. START/Add 1 Minute	L. Crisp
B. Cook Power	H. Cancel/Control Lock	M. Steam Cook
C. Popcorn	I. Turntable On/Off	N. Easy Convect
D. Microwave Oven Display	J. Clock/Tools	O. Defrost
E. Number Keypads	K. Soft Melt	P. Reheat
F. Timer Set/Off		

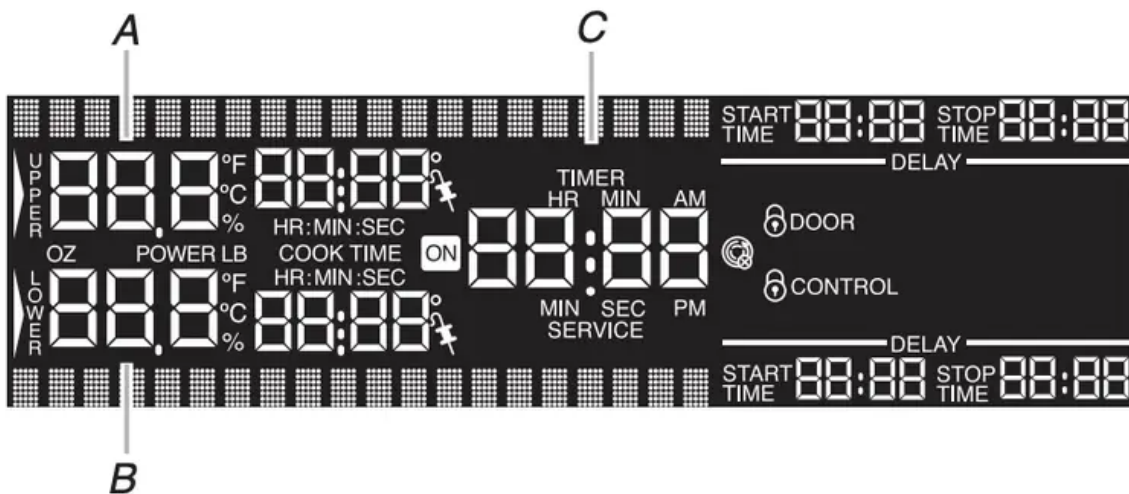

### **Upper and Lower Oven Display (combination oven models)**

- A. Microwave Cavity Display
- B. Oven Cavity Display
- C. Time of Day/Timer Display

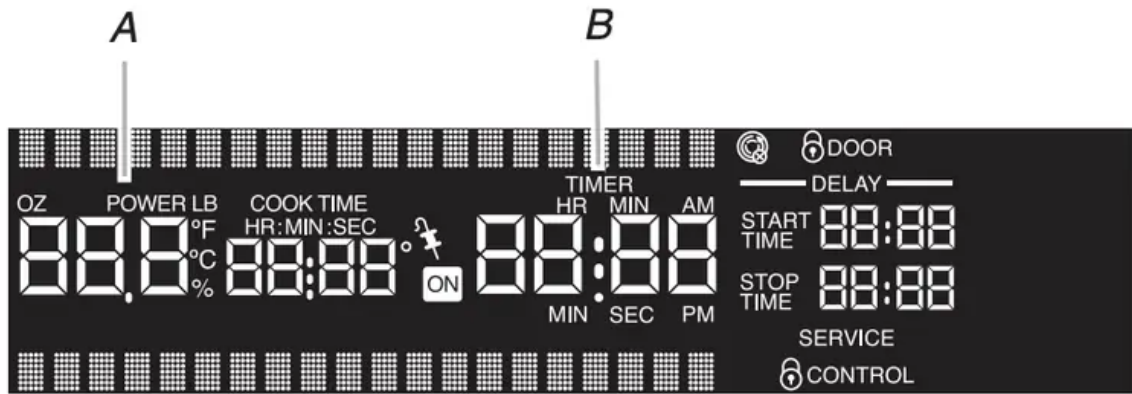

***Microwave Oven Display (single oven models)***

*A. Microwave Cavity Display*

*B. Time of Day/Timer Display*



KEYPAD	FEATURE	INSTRUCTIONS
<p><b>TIMER (SET/OFF)</b></p>	<p><b>Oven Timer</b></p>	<ol style="list-style-type: none"> <li>1. Touch <b>TIMER SET/OFF</b>. Touch again to switch between <b>MIN/SEC</b>, <b>HR/MIN</b> and <b>OFF</b>. If no action is taken, the control will continue to wait for a length of time to be entered.</li> <li>2. Touch the number keypads to set the length of time.</li> <li>3. Touch <b>TIMER SET/OFF</b>. If the keypad is not touched, the control will continue to wait for <b>TIMER SET/OFF</b> to be touched. When the set time ends, 4 chimes will continuously repeat until the <b>Timer Off</b> keypad is touched.</li> <li>4. If the <b>Cancel</b> keypad is touched, the oven will turn off; however, the <b>Timer</b> can only be turned off using the <b>Timer Off</b> keypad.</li> </ol>
<p><b>COOK TIME</b></p>	<p><b>Crisper Pan Frying</b></p>	<ol style="list-style-type: none"> <li>1. Touch <b>COOK TIME</b> and then number keypads to set a length of time to cook.</li> </ol> <p style="text-align: center;"><b>OR</b></p> <p>Touch the number keypads to set a length of time to cook. To use this feature, the display must be in the time of day visualization.</p> <p><b>NOTE:</b> Doneness function is not active for manual cooking.</p> <ol style="list-style-type: none"> <li>1. Touch <b>START</b>.</li> </ol> <p>The display will count down the cook time.</p> <p>When the stop time is reached, the oven will shut off automatically and “Cooking Complete” will appear on the oven display.</p> <p>If enabled, end-of-cycle tones will sound, and then reminder tones will sound every minute.</p> <ol style="list-style-type: none"> <li>1. Touch <b>CANCEL</b> or open the door to clear the display and/or stop reminder tones.</li> </ol>
<p><b>REHEAT</b></p>	<p><b>Reheat</b></p>	<ol style="list-style-type: none"> <li>1. Touch <b>REHEAT</b>.</li> <li>2. Touch number keypad to select food type from the <b>Reheat Chart</b>.</li> </ol> <p style="text-align: center;"><b>OR</b></p>



Touch REHEAT repeatedly to scan and select food settings. For example, to select the Casserole setting, REHEAT must be touched twice.

1. Touch number keypads to enter quantity (slices or cups).

To change the doneness setting, touch the COOK POWER keypad before or after the “Start?” prompt is displayed to toggle through and select a doneness of Normal, More or Less.

1. Touch START.

When the stop time is reached, the oven will shut off automatically and “reheat complete” will appear on the oven display.

If enabled, end-of-cycle tones will sound, and then reminder tones will sound every minute.

1. Touch CANCEL or open the door to clear the display and/or stop reminder tones

**REHEAT**

**Manual Reheat**

1. Touch REHEAT.
2. Touch the number “7” keypad.

**OR**

Touch REHEAT repeatedly to scan to the Manual setting.

3. Touch the number keypads to set a length of time to reheat. Reheat time can be set up to 99 minutes and 99 seconds.

NOTE: The doneness function is not active during manual reheating.

4. The default power level is 70%. To change the power level, touch COOK POWER and then enter the desired power level. See the Cooking Power Chart.

NOTE: If a cook time has not been entered, after 5 seconds of inactivity the power level will be automatically confirmed. The screen will then prompt to enter cook time.

5. Touch START. The upper oven display will count down the reheat time.

When the stop time is reached, the oven will shut off automatically and “Reheat Complete” will appear on the



		<p>oven display. If enabled, the end-of-cycle tones will sound. Reminder tones will then sound every minute after the cycle has been completed.</p> <p>6. Touch CANCEL or open the door to clear the display and stop the reminder tones.</p>
<b>REHEAT</b>	<b>Beverage Reheat</b>	<p>1. Touch REHEAT.</p> <p>2. Touch number keypad “3.”</p> <p style="text-align: center;"><b>OR</b></p> <p>Touch REHEAT repeatedly to scan and select the Beverage setting.</p> <p>3. Touch number keypad to enter cups, and then touch start.</p> <p>4. Touch number keypads 1 through 3 to select Warm, Hot or Very Hot.</p> <p style="text-align: center;"><b>OR</b></p> <p>Touch REHEAT repeatedly to scan and select temperature setting.</p> <p>NOTE: Doneness function not active for reheating beverages.</p> <p>5. Touch START.</p> <p>The upper oven display will count down the reheat time.</p> <p>When the stop time is reached, the oven will shut off automatically and “Reheat Complete” will appear on the oven display.</p> <p>If enabled, end-of-cycle tones will sound, and then reminder tones will sound every minute.</p> <p><b>IMPORTANT:</b> Heated liquids can splash out during and after heating. A wooden stir stick placed in the cup or bowl during heating may help avoid this.</p> <p>6. Touch CANCEL or open the door to clear the display and/or stop reminder tones.</p>
<b>DEFROST</b>	<b>Defrost</b>	<p>1. Touch DEFROST.</p> <p>2. Touch the number keypad from the Defrost Chart to select food.</p> <p style="text-align: center;"><b>OR</b></p>



		<p>Touch DEFROST repeatedly to scroll through foods. For example, to select the Meats setting, DEFROST must be touched twice.</p> <p>3. Touch number keypads to enter the weight.</p> <p>To change the doneness setting, touch the Cook Power keypad before or after the “Start?” prompt is displayed to toggle through and select a doneness of Normal, More or Less.</p> <p>4. Touch START.</p> <p>The upper oven display will count down the defrost time. For better results, a preset standing time is included in the defrosting time. This may make the defrosting time seem longer than expected.</p> <p>When the stop time is reached, the oven will shut off automatically and “Defrost Complete” will appear in the display.</p> <p>If enabled end-of-cycle tones will sound, and then reminder tones will sound every minute.</p> <p>5. Touch CANCEL or open the door to clear the display and/or stop reminder tones.</p>
<p><b>DEFROST</b></p>	<p><b>Manual Defrost</b></p>	<p>1. Touch DEFROST.</p> <p>2. Touch the number “6” keypad.</p> <p style="text-align: center;"><b>OR</b></p> <p>Touch DEFROST repeatedly to scan to the Manual setting.</p> <p>3. Touch the number keypads to set a length of time to defrost. Time can be set up to 99 minutes and 99 seconds.</p> <p><b>NOTE:</b> The doneness function is not available for manual defrosting.</p> <p>4. The default power level is 30%. To change power level, touch COOK POWER and then enter the desired power level. See the Cooking Power Chart.</p> <p><b>NOTE:</b> If a cook time has not been entered, after 5 seconds of inactivity the power level will be automatically confirmed. The screen will then prompt to enter cook time.</p>



		<p>5. Touch START. The upper oven display will count down the defrost time.</p> <p>When the stop time is reached, the oven will shut off automatically and “Defrost Complete” will appear on the oven display. If enabled, the end-of-cycle tones will sound. Reminder tones will then sound every minute after the cycle has been completed.</p> <p>6. Touch CANCEL or open the door to clear the display and stop the reminder tones.</p>
<b>STEAM COOK</b>	<b>Steam Cook</b>	<p>1. Touch STEAM COOK.</p> <p>2. Touch the number keypad to select a food type from the Steam Cooking Chart.</p> <p style="text-align: center;"><b>OR</b></p> <p>Touch STEAM COOK repeatedly to scan and select food type. For example, to select the Fresh Vegetables setting, Steam Cook must be touched twice.</p> <p>To change the doneness setting, touch the Power keypad before or after the “Start?” prompt is displayed to toggle through and select a doneness of Normal, More or Less.</p> <p>3. Touch START. The upper oven display will count down the steam time once the sensor identifies the cooking duration.</p> <p>When the steam time has ended, the oven will shut off automatically and “Steam Complete” will appear in the display.</p> <p>If enabled, end-of-cycle tones will sound, and then reminder tones will sound every minute.</p> <p>4. Touch CANCEL or open the door to clear the display and/or stop reminder tones.</p>
<b>STEAM COOK</b>	<b>Manual Steam Cook</b>	<p>1. Touch STEAM COOK.</p> <p>2. Touch the number keypad “6.”</p> <p style="text-align: center;"><b>OR</b></p> <p>Touch STEAM COOK repeatedly to scan and select the Manual steam setting.</p>



		<p>3. Touch the number keypads to set a length of time to steam. Time can be set up to 99 minutes and 99 seconds.</p> <p><b>NOTE:</b> Doneness function is not active for manual steam cooking.</p> <p>4. Touch START. Once the boiling point is reached the upper oven display will start to count down the steam time.</p> <p>When the stop time is reached, the oven will shut off automatically and “Steam Complete” will appear in the display.</p> <p>If enabled, end-of-cycle tones will sound, and then reminder tones will sound every minute.</p> <p>5. Touch CANCEL or open the door to clear the display and/or stop reminder tones.</p>
<b>POPCORN</b>	<b>Popcorn</b>	<p>1. Touch POPCORN.</p> <p><b>NOTE:</b> Doneness function is not active for popcorn setting.</p> <p>2. Touch START.</p> <p>When the stop time is reached, the oven will shut off automatically and “Cooking Complete” will appear in the display.</p> <p>If enabled, end-of-cycle tones will sound, and then reminder tones will sound every minute.</p> <p>3. Touch CANCEL or open the door to clear the display and/or stop reminder tones.</p>
<b>SOFTEN MELT</b>	<b>Soften</b>	<p>1. Touch SOFTEN MELT.</p> <p>2. Touch number keypad “2” to select Soften function.</p> <p style="text-align: center;"><b>OR</b></p> <p>Touch SOFTEN MELT repeatedly to scan and select Soften.</p> <p>3. Touch number keypad to select food type from the Soften Chart.</p> <p style="text-align: center;"><b>OR</b></p> <p>Touch SOFTEN MELT repeatedly to scan and select food settings.</p>



		<p>4. Touch number keypads to enter quantity (weight or sticks).</p> <p>To change the doneness setting, touch the Power keypad before or after the “Start?” prompt is displayed to toggle through and select a doneness of Normal, More or Less.</p> <p>5. Touch START.</p> <p>The upper oven display will count down the soften time.</p> <p>When the stop time is reached, the oven will shut off automatically and “Soften Complete” will appear in the display.</p> <p>If enabled, end-of-cycle tones will sound, and then reminder tones will sound every minute. 6. Touch CANCEL or open the door to clear the display and/or stop reminder tones.</p>
<p><b>SOFTEN MELT</b></p>	<p><b>Melt</b></p>	<p>1. Touch SOFTEN MELT.</p> <p>2. Touch number keypad “1” to select Melt function.</p> <p style="text-align: center;"><b>OR</b></p> <p>Touch SOFTEN MELT repeatedly to scan and select Melt.</p> <p>3. Touch number keypad to select food type from the Melt Chart.</p> <p style="text-align: center;"><b>OR</b></p> <p>Touch SOFTEN MELT repeatedly to scan and select food settings.</p> <p>4. Touch number keypads to enter quantity (weight or sticks).</p> <p>To change the doneness setting, touch the Power keypad before or after the “Start?” prompt is displayed to toggle through and select a doneness of Normal, More or Less.</p> <p>5. Touch START.</p> <p>The upper oven display will count down the melt time.</p> <p>When the stop time is reached, the oven will shut off automatically and “Melt Complete” will appear in the display.</p> <p>If enabled, end-of-cycle tones will sound, and then reminder tones will sound every minute.</p>



6. Touch CANCEL or open the door to clear the display and/or stop reminder tones.

## Display(s)

When power is first supplied to the oven, the timer display will flash “12:00,” and “Clock-enter time” will appear on the display. Enter the time by touching the number keypads. Then touch START to allow operation. To allow operation without changing the time, touch START or CANCEL.

### Lower Oven Display (combination oven models)

When the lower oven is in use, this display shows the oven temperature, heat source(s) and start time. In addition, during Timed Cooking, this display shows a time countdown and the stop time (if entered).

When the lower oven is not in use, this display shows the time of day or time countdown.

### Upper Microwave Oven Display (combination oven models)

When the upper oven is in use, this display shows the upper oven heat source(s), cooking power, quantities, weights and/or help prompts and time countdown.

When the upper oven is not in use, this display is blank.

### Microwave Oven Display (single oven models)

When the microwave oven is in use, the display shows the heat source(s), cooking power, quantities, weight and/or help prompts and time countdown.

### Time of Day/Timer

Display When the microwave oven is not in use, the display shows the time of day or time countdown.

## Number Codes

The oven is preset with shortcut number codes. A number code includes one or more of the following; food category, cooking power, cook time and food quantity or weight. See the code charts in the “Reheating,” “Defrosting,” “Steam,” “Soften/Melt,” and “EasyConvect™” sections for additional information.

## Start/Add 1 Minute

The Start/Add 1 Minute keypad controls 2 separate functions for the built-in microwave: Start and Add 1 minute.

### Start

The Start/Add 1 Min keypad begins any upper or single oven cooking function once enough data has been entered and the door is closed.

After enough data has been entered and the door is closed, "Start?" will appear on the oven display as a reminder. If the Start keypad is not touched within 5 minutes after touching another keypad, the oven display will return to the inactive mode and the programmed function will be canceled.

If cooking is interrupted by opening the door, touching Start/Add 1 Minute after the door is closed again will resume the preset cycle.

### Add 1 Minute

**Touching Start/Add 1 Minute when the microwave oven is off will start 1 minute of cook time at 100% power. To use this feature the display must be in the time of day visualization, and the lower oven must be off (combination models only). Touching Start/Add 1 Minute while the microwave oven is operating will add cook time to the current cycle by 1 minute. Multiple minutes can be added by repeatedly touching Start/Add 1 Minute.**

### Control Lock

**NOTE:** On microwave ovens, the Control lock is locked or unlocked by touching the "Cancel" keypad. On combination ovens, the Control lock is locked or unlocked by touching the lower oven "Start" keypad.

The Control Lock shuts down the control panel keypads to avoid unintended use of the oven. The Control Lock will remain set after a power failure, if set before the power failure occurs.

When the control is locked, only the Set/Start, Oven Light, and Timer Set/Off keypads will function.

The Control Lock is preset unlocked, but can be locked.

**To Lock Control:** Touch and hold lower oven START (on combination ovens only) or Cancel (on microwave ovens only) for approximately 3 seconds, until "Control Locked" appears on the lower text line and a lock icon appears in the display.

**To Unlock Control:** Repeat to unlock. "Control Unlocked" appears on the lower text line and the lock icon will be removed.

## **Microwave Oven Cancel**

The Cancel keypad stops any microwave oven function except for the Clock, Timer and Control Lock.

The oven will also turn off when the door is opened. When the door is opened, the element(s) and fan will turn off, but the oven light will remain on. Close the door and touch START to resume the preset cycle.

The oven cooling fan may continue to operate even after an oven function has been canceled or completed, depending on the oven temperature.

## **Clock**

This is a 12-hour clock. Before setting, make sure the oven, Timer, and Timed Cooking are off.

To Set:

1. Touch CLOCK/TOOLS.
2. Touch the number "1" keypad.
3. Touch the number keypads to set the time of day.
4. Touch CLOCK/TOOLS or START.

## **Tones**

Tones are audible signals, indicating the following:

### **One beep**

- Valid keypad touch
- Function has been entered

### **One chime**

- Preheat cycle has been completed

### **Three beeps**

- Invalid keypad touch

### Three chimes

- End of a cooking cycle

### Four chimes

- When timer reaches zero Includes using the Kitchen Timer for functions other than cooking.

### Tone Volume

The volume is preset at low, but can be changed to high.

**To Change:** Touch CLOCK/TOOLS and then “4” to toggle volume between high and low settings.

### All Tones

All tones are preset on, but can be turned off.

**To Turn Off/On:** Touch CLOCK/TOOLS and then “3” to toggle tones between On and Off settings.

**NOTE:** The Kitchen Timer is not affected by reminder tones.

### End-of-Cycle and Reminder Tones

The Timed Cooking end-of-cycle and reminder tones are preset on, but can be turned off. If all tones have been turned off, the end-of-cycle and reminder tones cannot be independently turned on.

**To Turn Tones Off/On:** Touch CLOCK/TOOLS and then “5” to toggle tones between On and Off settings.

**NOTE:** The Kitchen Timer is not affected by these reminder tones.

## Tools (Microwave Oven Models)

The Tools selection keypad allows access to some hidden functions within the Electronic Oven Control.

### To Use:

1. Touch CLOCK/TOOLS. The oven display will scroll through the various options. You can also touch the Clock/Tools keypad repeatedly to manually scroll through the list of options.
2. Touch the number keypad for the specific option to toggle the function setup. Use the following chart as a guide.

## TOOLS CHART

TOOLS	Microwave Only	Combo
1	Clock	Clock
2	Temp	Temp
3	Sound (On/Off)	Sound (On/Off)
4	Sound (High/Low)	Sound (High/Low)
5	End Tone	End Tone
6	Turntable	Calibrate
7	Language	Sabbath
8	Demo Mode	Turntable
9		Language
0		Demo Mode

### Fahrenheit and Celsius

The temperature is preset in Fahrenheit; however it can be changed to Celsius.

**To Change:** Touch CLOCK/TOOLS and then “2” to toggle temperature between Fahrenheit and Celsius settings.

When the temperature is in Fahrenheit, “°F” follows the oven temperature.

When the temperature is in Celsius, “°C” follows the oven temperature.

### Timer

The Timer can be set in minutes and seconds or hours and minutes and counts down the set time.

**NOTE:** The Timer does not start or stop the oven.

## BUILT-IN MICROWAVE OVEN USE

A magnetron in the oven produces microwaves which reflect off the metal floor, walls and ceiling and pass through the turntable and appropriate cookware to the food. Microwaves are attracted to and absorbed by fat, sugar and water molecules in the food, causing them to move, producing friction and heat which cooks the food.

- To avoid damage to the microwave oven, do not lean on or allow children to swing on the microwave oven door.
- To avoid damage to the microwave oven, do not operate microwave oven when it is empty.
- The turntable must be in place and correct side up when microwave oven is in use. Do not use if turntable is chipped or broken. See “Assistance or Service” section to reorder.
- Baby bottles and baby food jars should not be heated in microwave oven.
- Clothes, flowers, fruit, herbs, wood, gourds, paper, including brown paper bags and newspaper, should not be dried in microwave oven.
- Paraffin wax will not melt in the microwave oven because it does not absorb microwaves.
- Use oven mitts or pot holders when removing containers from microwave oven.
- Do not overcook potatoes. At the end of the recommended cook time, potatoes should be slightly firm. Let potatoes stand for 5 minutes. They will finish cooking while standing.
- Do not cook or reheat whole eggs inside the shell. Steam buildup in whole eggs may cause them to burst. Cover poached eggs and allow a standing time.

## **Food Characteristics**

When microwave cooking, the amount, size and shape, starting temperature, composition and density of the food affect cooking results.

### **Amount of Food**

The more food heated at once, the longer the cook time needed. Check for doneness and add small increments of time if necessary.

### **Size and Shape**

Smaller pieces of food will cook more quickly than larger pieces, and uniformly shaped foods cook more evenly than irregularly shaped food.

### **Starting Temperature**

Room temperature foods will heat faster than refrigerated foods, and refrigerated foods will heat faster than frozen foods.

### **Composition and Density**

Foods high in fat and sugar will reach a higher temperature, and will heat faster than other foods. Heavy, dense foods, such as meat and potatoes, require a longer cook time than the same size of a light, porous food, such as cake.

## **Cooking Guidelines**

### **Covering**

Covering food helps retain moisture, shorten cook time and reduce spattering. Use the lid supplied with cookware. If a lid is not available, wax paper, paper towels or plastic wrap approved for microwave ovens may be used. Plastic wrap should be turned back at one corner to provide an opening to vent steam. Condensation on the door and cavity surfaces is normal during heavy cooking.

### **Stirring and Turning**

Stirring and turning redistribute heat evenly to avoid overcooking the outer edges of food. Stir from outside to center. If possible, turn food over from bottom to top.

### **Arranging**

If heating irregularly shaped or different sized foods, arrange the thinner parts and smaller sized items toward the center. If cooking several items of the same size and shape, place them in a ring pattern, leaving the center of the ring empty.

### **Piercing**

Before heating, use a fork or small knife to pierce or prick foods that have a skin or membrane, such as potatoes, egg yolks, chicken livers, hot dogs, and sausage. Prick in several places to allow steam to vent.

### **Shielding**

Use small, flat pieces of aluminum foil to shield the thin pieces of irregularly shaped foods, bones and foods such as chicken wings, leg tips and fish tails. See “Aluminum Foil and Metal” first.

### **Standing Time**

Food will continue to cook by the natural conduction of heat even after the microwave cooking cycle ends. The length of standing time depends on the volume and density of the food.

### **Turntable On/Off**

For best performance, the turntable should be on during microwave cooking.

If using oversized cookware that does not turn freely on the microwave turntable, turn the turntable Off. To turn off the turntable, touch TURNTABLE ON/OFF. When cooking with the turntable off, food should be turned halfway through the cooking process.

**NOTE:** The turntable cannot be turned off during any auto cooking cycle.

## **Cookware and Dinnerware**

Cookware and dinnerware must fit on the turntable. Always use oven mitts or pot holders when handling because any dish may become hot from heat transferred from the food. Do not use cookware and dinnerware with gold or silver trim. Use the following chart as a guide, then test before using.

<b>MATERIAL</b>	<b>RECOMMENDATIONS</b>
Aluminum Foil, Metal	See “Aluminum Foil and Metal” section.
Browning Dish	Bottom must be at least $\frac{3}{16}$ " (5 mm) above the turntable. Follow manufacturer’s recommendations.
Ceramic Glass, Glass	Acceptable for use.
China, Earthenware	Follow manufacturer’s recommendations.
Melamine	Follow manufacturer’s recommendations.
Paper: Towels, Dinnerware, Napkins	Use nonrecycled and those approved by the manufacturer for microwave oven use.
Plastic: Wraps, Bags, Covers, Dinnerware, Containers	Use those approved by the manufacturer for microwave oven use.
Pottery and Clay	Follow manufacturer’s recommendations.
Silicone Bakeware	Follow manufacturer’s recommendations.
Straw, Wicker, Wooden Containers	Do not use in microwave oven.
Styrofoam <sup>®†</sup>	Do not use in microwave oven.
Wax Paper	Acceptable for use.

To Test Cookware or Dinnerware for Microwave Use:

1. Place cookware or dinnerware in microwave oven with 1 cup (250 mL) of water beside it.
2. Cook at 100% cooking power for 1 minute.

Do not use cookware or dinnerware if it becomes hot and the water stays cool.

## Aluminum Foil and Metal

Always use oven mitts or pot holders when removing dishes from the microwave oven.

Aluminum foil and some metal can be used in the microwave oven. If not used properly, arcing (a blue flash of light) can occur and cause damage to the microwave oven.

### **OK for Use**

Racks and bakeware supplied with the microwave oven (on some models), aluminum foil for shielding, and approved meat thermometers may be used with the following guidelines:

- To avoid damage to the microwave oven, do not allow aluminum foil or metal to touch the inside cavity walls, ceiling or floor.
- Always use the turntable.
- To avoid damage to the microwave oven, do not allow contact with another metal object during microwave cooking.

### **Do Not Use**

Metal cookware and bakeware, gold, silver, pewter, non-approved meat thermometers, skewers, twist ties, foil liners such as sandwich wrappers, staples and objects with gold or silver trim or a metallic glaze should not be used in the microwave oven.

### **Positioning Baking Tray**

Baking tray can only be used with convection cooking and broiling (on some models). To avoid damage to the microwave oven, do not use baking tray in combination with microwave cooking.

Place baking tray on slide rails as shown below. Push in tray to stop position. Check that the baking tray is level.

For best cooking results, use baking tray only in the recommended position.

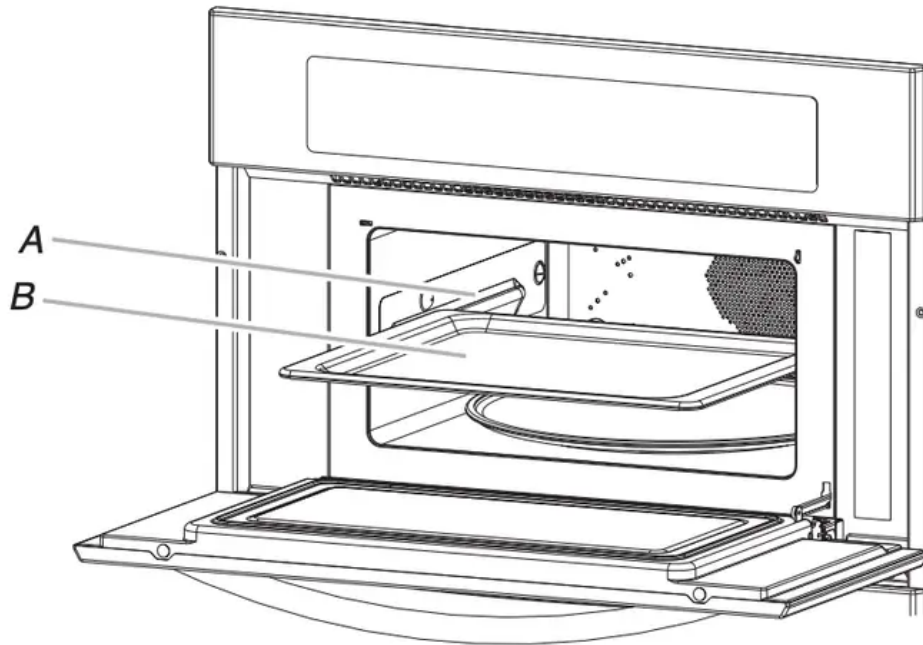

*A. Slide rail*

*B. Baking tray*

## **Microwave Cooking Power**

Many recipes for microwave cooking specify which cooking power to use by percent, name or number. For example, 70%=7=Medium-High.

Use the following chart as a general guide for the suggested cooking power of specific foods.

### **MICROWAVE COOKING POWER CHART**

<b>PERCENT/NAME</b>	<b>NUMBER</b>	<b>USE</b>
100%, High (default setting)	10	Quick heating convenience foods and foods with high water content, such as soups, beverages and most vegetables.
90%	9	Cooking small, tender pieces of meat, ground meat, poultry pieces and fish fillets. Heating cream soups.
80%	8	Heating rice, pasta or casseroles. Cooking and heating foods that need a cook power lower than high. For example, whole fish and meat loaf.
70%, Medium-High	7	Reheating a single serving of food.
60%	6	Cooking sensitive foods such as cheese and egg dishes, pudding and custards. Cooking non-stirrable casseroles, such as lasagna.
50%, Medium	5	Cooking ham, whole poultry and pot roasts. Simmering stews.
40%	4	Melting chocolate. Heating bread, rolls and pastries.
30%, Medium-Low, Defrost	3	Defrosting bread, fish, meats, poultry and precooked foods.
20%	2	Softening butter, cheese, and ice cream.
10%, Low	1	Taking chill out of fruit.

**NOTE:** A percentage of 0% is also acceptable. This will not heat up.

To Set a Cooking Power other than 100%:

1. Touch the number keypads to set a length of time to cook.
2. Touch COOK POWER.
3. Using the Microwave Cooking Power chart above, enter the corresponding number for the desired power level.
4. Touch START. The display will count down the cook time. When the stop time is reached, the oven will shut off automatically and the end screen will appear on the display. If enabled, end-of-cycle tones will sound, then reminder tones will sound every minute.
5. Touch CANCEL or open the door to clear the display and/or stop reminder tones.

## Doneness

Doneness is a function used for adjusting the cook time. This feature is used on all sensor and non-sensor functions with the exception of Manual Cooking, Popcorn, EasyConvect™, Custom Reheat (beverage-manual), Defrost (manual) and Steam (manual).

The 3 Doneness levels are Normal (default), More or Less and will appear once activated on the lower text line of the upper oven display. Doneness can be changed only before starting the cycle.

To Change Doneness Setting:

After setting a function, the Doneness setting can be changed if desired. This can be done before or after the "START?" prompt appears in the display. Touch the COOK POWER keypad repeatedly to toggle through Doneness options of Normal, More or Less.

## Sensor Cook

The Sensor Cook function is used in Reheat (meal), Steam Cooking and Popcorn.

During the Sensor Cook function a sensor automatically adjusts for the cook time and power level.

The microwave oven display will show the "Maximum Time Remaining" prompt and the time countdown once the sensor identifies the cooking duration. I

f the microwave oven door is opened during a sensor function, the microwave oven will turn off, and any additional operations will be canceled.

### **For best cooking performance:**

Before using a sensor cook function, make sure power has been supplied to the microwave oven for at least 2 minutes, the room temperature is not above 95°F (35°C), and the outside of the cooking container and the microwave oven cavity are dry.

## Manual Cooking

To Use:

1. Touch COOK TIME and then number keypads to set a length of time to cook.

**OR**

Touch the number keypads to set a length of time to cook. To use this feature, the display must be in the time of day visualization. Time can be set up to 99 minutes and 99 seconds.

If using 100% cook power, skip to Step 3.

2. Touch COOK POWER, and then enter the desired power level. See the Microwave Cooking Power Chart in the “Microwave Cooking Power” section.

**NOTE:** Doneness function is not active for manual cooking.

3. Touch START/ADD 1 MINUTE.

The display will count down the cook time.

Touching Start/Add 1 Minute while the microwave oven is operating will add cook time to the current cycle by 1 minute. Multiple minutes can be added by repeatedly touching Start/Add 1 Minute.

When the stop time is reached, the oven will shut off automatically and “Cooking Complete” will appear on the oven display.

If enabled, end-of-cycle tones will sound, and then reminder tones will sound every minute.

4. Touch CANCEL or open the door to clear the display and/or stop reminder tones.

## Crisper Pan Frying

When the crisper pan is used with microwaves, it is like a frying pan or griddle, ideal for French toast, burgers, eggs, stir-frying and sautéing.

Before using, see “Crisper Pan and Handle” section and the Crisper Pan Frying Chart.

Always use the turntable “On” option when using the crisper pan (default setting).

Before Use:

Preheat pan for 3 minutes on 100% power. Use 100% power for cooking.

Before crisper pan frying, brush crisper pan with ½ tsp (3 mL) of oil or spray with nonstick cooking spray. Arrange food on crisper pan. Place pan on turntable.

Use the following chart as a guide.

### CRISPER PAN FRYING CHART

<b>FOOD</b>	<b>COOKTIME*</b>	<b>INSTRUCTIONS</b>
Eggs, Fried 2 eggs	Side 1: 30-45 sec Side 2: 30-45 sec	Times are for over-easy doneness.
4 eggs	Side 1: 1 min Side 2: 45 sec	
Omelet 4 eggs	2-3 min	Mix eggs and 4 tbs of water.
Sausage Patties 1.5 oz (42.5 g) each 4 patties	Side 1: 2 min Side 2: 1 min 30 sec	Cook until 160°F (70°C)
8 patties	Side 1: 3 min Side 2: 2 min 30 sec	
Vegetables, stir-fry, 2 cups (500 mL)	4-5 min	Cut vegetables in equal sizes. Stir halfway through cooking.
Nuts 1 cup (250 mL) 2 cups (500 mL)	3 min 4 min	Stir halfway through cooking.

\*Times are approximate and may be adjusted for individual tastes.

## Reheat

Times and cooking powers have been preset for reheating a number of food types.

Manual Reheat requires that a cook time and a power level be entered if using other than 70% cook power.

Use the following chart as a guide.

### REHEAT CHART

<b>FOOD</b>	<b>CODE</b>	<b>QUANTITY</b>
<b>Meal</b> Place food on plate. Cover with plastic wrap and vent. Let stand 2-3 minutes after reheating.	1	8-16 oz (227-454 g)
<b>Casserole</b> Place in microwave-safe container. Cover with plastic wrap and vent. Stir and let stand 2-3 minutes after reheating.	2	1-4 cups (250 mL-1 L)
<b>Beverage</b> Do not cover.	3	1-2 cups (250 mL-500 mL)
<b>Pizza</b> Place on a paper towel lined microwave-safe plate.	4	1-3 slices [3 oz (85 g) each]
<b>Soup</b> Place in microwave-safe container. Cover with plastic wrap and vent. Stir and let stand 2-3 minutes after reheating.	5	1-4 cups (250 mL-1 L)
<b>Sauce</b> Place in microwave-safe container. Cover with plastic wrap and vent. Stir and let stand 2-3 minutes after reheating.	6	1-4 cups (250 mL-1 L)
<b>Manual</b>	7	Default power level 70%

## Defrost

The Defrost feature can be used, or the microwave oven can be manually set to defrost by using 30% cook power.

- For optimal results, food should be 0°F (-18°C) or colder when defrosting.
- Unwrap foods and remove lids (from fruit juice) before defrosting.
- Shallow packages will defrost more quickly than deep blocks.

- Separate food pieces as soon as possible during or at the end of the cycle for more even defrosting.
- Foods left outside the freezer for more than 20 minutes or frozen ready-made food should not be defrosted using the Defrost feature, but should be defrosted manually.
- Use small pieces of aluminum foil to shield parts of food such as chicken wings, leg tips and fish tails. See “Aluminum Foil and Metal” first.
- Times and cooking powers have been preset for defrosting a number of food types.
- Manual Defrost requires that a cook time and power level be entered if using other than 30% cook power. Use the following chart as a guide.

#### DEFROST CHART

FOOD	CODE	WEIGHT
Poultry*	1	0.1 - 6.6 lbs (45 g - 3 kg)
Meats*	2	0.1 - 6.6 lbs (45 g - 3 kg)
Fish*	3	0.1 - 6.6 lbs (45 g - 3 kg)
Bread	4	0.1 - 2.0 lbs (45 g - 907 g)
Juice	5	6, 12 or 16 oz (177, 355 or 473 mL)
Manual	6	Default power level 30%

\*See the Defrost Preparation Chart at end of “Defrost” section for cuts, sizes, and instructions.

Use the following chart as a guide when defrosting meat, poultry, or fish.

#### DEFROST PREPARATION CHART

<b>MEAT</b>	
<i>Beef:</i> ground, steaks, roast, stew	<p>The narrow or fatty areas of irregular shaped cuts should be shielded with foil before defrosting.</p> <p>Do not defrost less than ¼ lb (113 g) or two 4 oz (113 g) patties.</p> <p>Place all meats in microwave-safe baking dish.</p>
<i>Lamb:</i> stew and chops	
<i>Pork:</i> chops, ribs, roasts, sausage	
<b>POULTRY</b>	
<i>Chicken:</i> whole and cut up	<p>Place in microwave-safe baking dish, chicken breast side up.</p> <p>Remove giblets from whole chicken.</p>
<i>Cornish hens</i>	
<i>Turkey:</i> breast	
<b>FISH</b>	
<i>Fillets, Steaks, Whole, Shellfish</i>	Place in microwave-safe baking dish.

## Steam Cooking

Steam Cook is a sensor cooking function that uses microwaves to steam food. Always use steamer vessel. See the “KitchenAid™ Steamer Vessel” section before using. Use Steam Cook for foods such as vegetables, fish and potatoes.

- Times and cooking powers have been preset for steaming a number of food types.
- Manual Steam Cook requires that a cook time be entered.
- It is recommended to add ½ cup (125 mL) of water to Steamer Vessel before steaming.

Use the following chart as a guide.

### STEAM COOKING CHART

FOOD	CODE	QUANTITY
Potatoes	1	2-6 cups (500 mL-1.5 L)
Fresh vegetables	2	2-6 cups (500 mL-1.5 L)
Frozen vegetables	3	2-6 cups (500 mL-1.5 L)
Fish	4	8-16 oz (227-454 g)
Shrimp	5	5-10 oz (142-283 g)
Manual	6	Sensing

## Popcorn

- Do not use regular paper bags or glassware.
- Pop only 1 package of popcorn at a time.
- Follow manufacturer's instructions when using a microwave popcorn popper.
- Listen for popping to slow to 1 pop every 1 or 2 seconds, and then stop the cycle. Do not repop unpopped kernels.
- For best results, use fresh bags of popcorn.
- Cooking results may vary by brand and fat content.
- Recommended bag sizes are 3.5 oz, 3.0 oz, and 1.75 oz.

**NOTE:** Follow the instructions provided by the microwave popcorn manufacturer.

## Keeping Food Warm

**! WARNING**

**Food Poisoning Hazard**

**Do not let food sit in oven more than one hour before or after cooking.**

**Doing so can result in food poisoning or sickness.**

**Hot cooked food can be kept warm in the microwave oven.**

- **Cover plates of food.**

- **Cover foods that were covered while being cooked.**

- **Do not cover baked goods such as pastries, pies, turnovers, etc.**

To Keep Food Warm:

1. Touch COOK TIME and then number keypads to set a length of time to warm.

**OR**

Touch the number keypads to set a length of time to warm. To use this feature, the display must be in time of day visualization.

2. Touch COOK POWER. 3. Touch number keypad "1" to set cook power at 10%.

**NOTE:** Doneness function is not active for manual cooking.

4. Touch START.

The display will count down the warming time.

When the stop time is reached, the oven will shut off automatically and "Cooking Complete" will appear in the display.

If enabled, end-of-cycle tones will sound, and then reminder tones will sound every minute.

5. Touch CANCEL or open the door to clear the display and/or stop the reminder tones.

## **Crisp**

The Crisp feature uses the broil element and microwaves to crisp and brown foods. Crisp can be used to saute meats and vegetables, pan-fry bacon and eggs, and to crisp and brown pizza and french fries. Always use the crisper pan. See the "Crisper Pan and Handle" section before using.

- The crisper pan will become very hot. Use oven mitts or detachable handle to grasp and remove the pan from the oven.

- Do not place hot crisper pan directly on heat-sensitive surfaces. Damage may occur.

- Do not use plastic utensils on the crisper pan, as it becomes very hot quickly and could melt the utensils.

- Do not use metal utensils, as they can scratch the pan.

- Do not use the crisper pan in any other microwave oven or in a standard thermal oven.

- Do not place the crisper pan on the convection rack or the baking tray. Always use the turntable as a support for the pan.

- Always use the turntable “On” option when crisping (default setting).

To Crisp:

Before Crisping, brush crisper pan with ½ tsp (3 mL) of oil or spray with nonstick cooking spray. For best results, the crisper pan should be preheated for 3 minutes. Arrange food on crisper pan, and place pan on turntable.

1. Touch CRISP.

The “Use Crisp Pan” prompt will appear momentarily in the display as a reminder to use the crisp pan.

2. Touch the number keypads to enter a length of time to cook in minutes and seconds. The time can be set up to 99 minutes and 99 seconds.

3. Touch START.

The upper oven display will count down the crisp time.

When the stop time is reached, the oven will shut off automatically and “Cooking Complete” will appear in the display.

If enabled, end-of-cycle tones will sound, and then reminder tones will sound every minute.

4. Touch CANCEL or open the door to clear the display and/or stop the reminder tones.

Use the following chart as a guide.

#### CRISPING CHART

<b>FOOD</b>	<b>COOK TIME (MINUTES)*</b>	<b>PREPARATION</b>
Bacon, 4 strips	Side 1: 3:00 Side 2: 1:45	Place in crisper pan in a single layer
Frozen french fries, 2 servings	Side 1: 5:00 Side 2: 2:00	Place in crisper pan in a single layer
Boneless chicken breasts, 2 pieces	Side 1: 4:00 Side 2: 3:00	5-6 oz (142-170 g) each
Hamburger patties, 2	Side 1: 3:30 Side 2: 2:00	4 oz (113 g) each, ½" (1.3 cm) thick
Frozen thin crust pizza	8:00-9:00	

\*Times are approximate and may be adjusted for individual tastes.

## Soften/Melt

Soften and Melt functions may be used to soften or melt your food. Times and cooking powers have been preset for a number of food types. Use the following chart as a guide.

SOFTEN CHART

FOOD	CODE	QUANTITY	PREPARATION
Butter	1	½-2 sticks	Unwrap and place in microwave-safe container.
Margarine	2	½-2 sticks	
Ice cream	3	16, 32, or 64 oz (454, 907 g, or 1.8 kg)	
Cream cheese	4	3 or 8 oz (85 g or 227 g)	Unwrap and place in microwave-safe container.

Use the following chart as a guide.

MELT CHART

FOOD	CODE	QUANTITY	PREPARATION
Butter	1	½-2 sticks	Unwrap and place in microwave-safe container.
Margarine	2	½-2 sticks	
Chocolate	3	2, 4, 6, 8 oz (57, 113, 170, 227 g)	Cut squares into small pieces or use chips. Place in microwave-safe container.
Cheese	4	8 or 16 oz (227 or 454 g)	Cut into small pieces and place in microwave-safe container.
Marshmallows	5	5 or 10 oz (142 or 283 g)	Place in microwave-safe container.

## EasyConvect™ Conversion

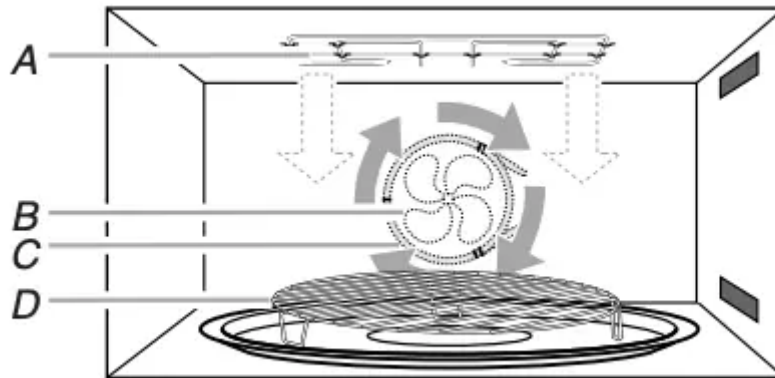

*A. Broil element*

*B. Convection fan*

*C. Convection element*

*D. Convection grid*

Convection cooking uses the convection element, the broil element and the fan. Hot air is circulated throughout the oven cavity by the fan. The constantly moving air surrounds the food to heat the outer portion quickly.

- The convect function may be used to cook small amounts of food on a single rack.
- Always use the convection grid placed on turntable or baking tray.
- Always use the turntable “On” option when convection cooking with the convection grid (default setting).
- Do not cover turntable or convection grid or baking tray with aluminum foil.
- Do not use light plastic containers, plastic wrap or paper products. All heatproof cookware or metal utensils can be used in convection cooking. Round pizza pans are excellent for convection cooking.
- Use convection cooking for items such as souffles, breads, cookies, angel food cakes, pizza, and most meats and fish.
- All EasyConvect™ functions require preheating before use. Place food in microwave oven after preheating is complete.

EasyConvect™ Conversion is a function that converts a standard thermal bake cook time and temperature into an ideal cook time and temperature for convection cooking after the oven has preheated.

Convection temperatures and times differ from those of standard cooking. The oven can automatically reduce standard recipe temperatures and times for convection cooking.

The conversion may not be exact because foods are grouped in general categories. Use the following chart as a guide.

#### CONVECTION CHART

SETTING	FOODS	CODE
<b>BAKED GOODS</b>	Biscuits, Breads: quick and yeast, Cakes and Cookies Casseroles: including frozen entrées and soufflés Fish	1
<b>MEATS</b>	Baked potatoes Chicken: whole and pieces, Meat loaf, Roasts: pork, beef and ham *Turkey and large poultry are not included because their cook times vary.	2
<b>OTHER FOODS</b>	Convenience foods: french fries, nuggets, fish sticks, pizza, Pies: fruit and custard	3

To Use:

1. Position convection grid on turntable in microwave oven, or place baking tray on slide rails and close the door.
2. Touch EASYCONVECT™ function.
3. Touch number keypad to select food category from the Convection Chart.

**OR**

Touch EASYCONVECT™ function repeatedly to scan and select food category. For example, to select the Meats setting, EasyConvection™ must be touched twice.

4. Touch the number keypads to set a standard temperature. Temperature can be set between 170°F and 450°F (77°C and 232°C).
5. Touch the number keypads to set a length of standard time to cook. Time can be set up to 11 hours and 59 minutes.

**NOTE:** Doneness function not active for EasyConvection™.

6. Touch START. “Preheating” and “Lo” will appear on the upper oven display. Once the temperature reaches 170°F (77°C), “Lo” will be replaced by the increasing temperature. Time and temperature will be automatically converted for convection cooking.

When preheating is complete, 2 tones will sound, and the display will show the set temperature and “Insert Food” prompt.

7. Place food or bakeware on convection grid or on baking tray and close the door.

8. Touch START. The upper oven display will count down the cook time and show temperature for convection cooking.

When the stop time is reached, the oven will shut off automatically and “Cooking Complete” will appear on the oven display.

If enabled, end-of-cycle tones will sound, and then reminder tones will sound every minute.

9. Touch CANCEL or open the door to clear the display and/or stop reminder tones.

## BUILT-IN MICROWAVE OVEN CARE

### General Cleaning

**IMPORTANT:** Before cleaning, make sure all controls are off and the microwave oven is cool. Always follow label instructions on cleaning products.

Soap, water and a soft cloth or sponge are suggested first, unless otherwise noted.

### STAINLESS STEEL (on some models)

**NOTE:** To avoid damage to stainless steel surfaces, do not use soap-filled scouring pads, abrasive cleaners, Cooktop Polishing Creme, steel-wool pads, gritty washcloths or abrasive paper towels. Damage may occur to stainless steel surfaces, even with one-time or limited use.

Rub in direction of grain to avoid damaging.

Cleaning Method:

- affresh® Stainless Steel Cleaner Part Number W10355016 (not included): See “Assistance or Service” section to order.

- Vinegar for hard water spots.

### MICROWAVE OVEN DOOR EXTERIOR

Cleaning Method:

- Glass cleaner and a soft cloth or sponge: Apply glass cleaner to soft cloth or sponge, not directly on panel.
- affresh® Kitchen Appliance Cleaner Part Number W10355010 (not included): See “Assistance or Service” section to order.

## **MICROWAVE OVEN CAVITY**

To avoid damage to microwave oven cavity, do not use soap-filled scouring pads, abrasive cleaners, steel-wool pads, gritty washcloths or some paper towels.

On stainless steel models, rub in direction of grain to avoid damaging.

The area where the oven door and frame touch when closed should be kept clean.

### **Cleaning Method:**

#### **Average soil**

- Mild, nonabrasive soaps and detergents: Rinse with clean water and dry with soft, lint-free cloth.

#### **Heavy soil**

- Mild, nonabrasive soaps and detergents: Heat 1 cup (250 mL) of water for 2 to 5 minutes in oven. Steam will soften soil. Rinse with clean water and dry with soft, lintfree cloth.

#### **Odors**

- Lemon juice or vinegar:
  - Heat 1 cup (250 mL) of water with 1 tbs (15 mL) of either lemon juice or vinegar for 2 to 5 minutes in oven.

## **MICROWAVE OVEN CEILING**

The broil element does not need cleaning since the intense heat will burn off any food spatters. However, the ceiling above the broil element may need regular cleaning.

### **Cleaning Method:**

- Warm water, mild detergent and a sponge.

#### **To clean:**

1. Push the fastening thread gently towards the back of the ceiling and then lower it to release the broil element.

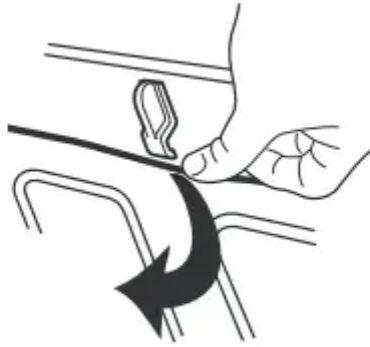

2. Lower the front of the broil element to access the ceiling for cleaning.

3. Raise broil element back up and return the fastening thread back to its original location.

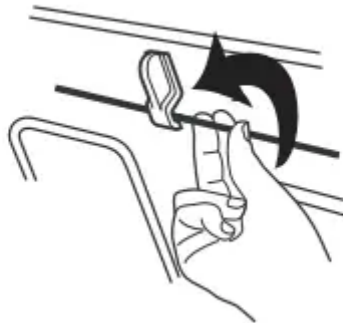

Always return the broil element to the cooking position after cleaning.

## **TURNTABLE**

Replace turntable immediately after cleaning.

Do not operate the microwave oven without the turntable in place.

### **Cleaning Method:**

- Mild cleanser and scouring pad
- Dishwasher

## **RACK**

- Steel-wool pad
- Dishwasher

## **CRISPER PAN**

To avoid damage to browning pan, do not immerse or rinse with water while the crisper pan is hot. Do not use steel-wool pads.

### **Cleaning Method:**

- Warm water, mild detergent and a sponge. Heavily soiled areas can be cleaned with a scouring pad and mild cleanser.
- Dishwasher

### **BAKING TRAY**

- Dishwasher

### **STEAMER**

- Dishwasher

### **TURNTABLE SUPPORT AND ROLLERS, HUB, CRISPER PAN HANDLE**

- Dishwasher

## **TROUBLESHOOTING**

Try the solutions suggested here first in order to avoid the cost of an unnecessary service call.

### **Nothing will operate**

- **Has a household fuse blown, or has the circuit breaker tripped?**

Replace the fuse or reset the circuit breaker. If the problem continues, call an electrician.

- **Is the appliance wired properly?**

See Installation Instructions.

### **Microwave oven will not operate**

- **Is the door completely closed?**

Firmly close door.

- **Is the electronic oven control set correctly?**

See “Electronic Oven Control” section.

- **On some models, is the Control Lock set?**

See “Control Lock” section.

- **On combination oven models, is the lower oven selfcleaning?**

The upper oven will not work during the lower oven SelfCleaning Cycle.

- **Is the magnetron working properly?**

Try to heat 1 cup (250 mL) of cold water for 2 minutes at 100% cooking power. If water does not heat, call for service. See “Assistance or Service” section.

### **Microwave oven makes humming noise**

- This is normal and occurs when the transformer in the magnetron cycles on.

### **Microwave oven door looks wavy**

- This is normal and will not affect performance.

### **Turntable will not operate**

- **Is the turntable properly in place?**

Make sure turntable is correct side up and is sitting securely on the turntable support.

- **Is the turntable support operating properly?**

Remove turntable. Remove and clean turntable support and rollers. Replace turntable support. Replace turntable. Place 1 cup (250 mL) of water on the turntable, then restart oven. If it still is not working, call for service. See “Assistance or Service” section. Do not operate the oven without turntable and turntable support working properly.

### **Turntable rotates both directions**

- This is normal and depends on motor rotation at beginning of cycle.

### **Display shows messages**

- **Is the display showing a letter followed by a number?**

Clear the display. See “Display(s)” section. If it reappears, call for service. See “Assistance or Service” section.

### **Display shows time countdown, but is not operating**

- **Is the Timer in use?**

See “Timer” section.

### **Tones are not sounding**

- **Are tones disabled?**

See “Tones” section.

## Fan stays on after cooking is completed

- Depending on the temperature inside the microwave oven after a cooking cycle ends, the cooling fan may continue to run for some time in order to cool the microwave oven. The turntable may also continue to rotate and the light may stay on during this time. This is normal. The door may be opened at any time to add or remove food, and/or to start another cooking cycle.

## Smoke is coming from oven vent during crisping

- Some smoke is normal and occurs just as in conventional crisping.

## Sparking during crisping

- This is normal and occurs as fat burns off from past cooking. Sparking will stop once fat is completely burned off.

## Cooking times seem too long

- **Is the cooking power set properly?**

See “Microwave Cooking Power” in the “Microwave Oven Use” section.

- **Are large amounts of food being heated?**

Larger amounts of food need longer cooking times.

- **Is the incoming voltage less than that specified in the “Electrical Requirements” section?**

Have a qualified electrician check the electrical system of the house.

## Radio or TV Interference

- **Is the microwave oven plugged into the same outlet?**

Try a different outlet.

- **Is the radio or TV receiver near the microwave oven?**

Move the receiver away from the microwave oven, or adjust the radio or TV antenna.

- **Are the microwave oven door and sealing surfaces clean?**

Make sure these areas are clean.

### Warning

This content is compiled from multiple sources and is provided for reference purposes only. It may not be complete or fully applicable to all situations. If you are unable to resolve your issue, please contact the product manufacturer or an authorized service provider for official support.

---

Document generated by [ManualsFile](#)

