

## Connections and setup

### Before initial setup

Protect against power surges

- Connect all components before you plug any power cords into the wall outlet or power strip.
- NEVER plug your TCL Roku TV into an outlet that is controlled by a wall switch.
- Turn off the TV before you connect or disconnect any cables.
- Make sure all antennas and cables are properly grounded. Refer to the Important Safety Instructions.

Safety information

- Prevent TV from overheating by placing in an area with good ventilation.
- Do not block ventilation holes on the TV. Position the TV so air can circulate freely on all sides.
- Do not stack objects on the TV.
- If you place the TV on a stand, make sure you allow adequate ventilation.
- If you connect an audio receiver or amplifier to the TV, place it on the top shelf so the heated air will not overheat the TV.

Avoid audio interference

- Position cables properly; insert each cable firmly into the designated jack.
- Route all cables down one side of the back of the TV instead of straight down the middle.
- If your antenna uses 300-ohm twin lead cables, do not coil the cables.
- Keep twin lead cables away from audio/video cables.

Avoid direct light

- Do not place the TV where sunlight or room lighting is directed toward the screen. Use soft or indirect lighting.

Set up your new TV

- Open the box and remove the TV and other items. Be careful, the TV is heavy! We strongly recommend that two people unbox the TV.
- Be sure to check all the foam packaging as the stands from some TV's are stored in the foam for protection.

What's in the box

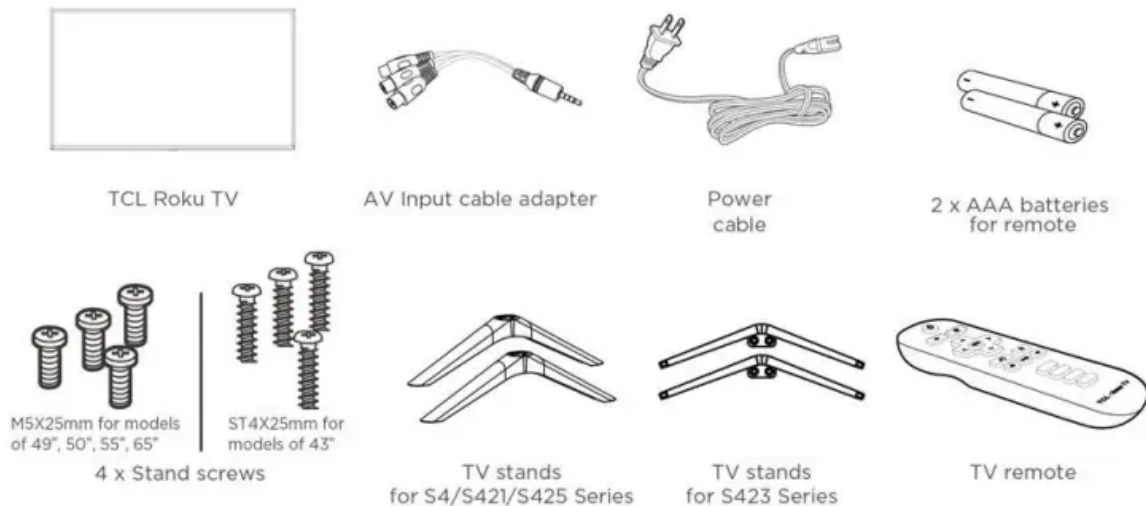

To mount on a wall: If you are mounting your TCL Roku TV to the wall, do not attach the TV base stand or TV stand column. To mount your TV to the wall, purchase the one of the following VESA wall mounts:

- 43" model VESA 100 x 100, M6 x 12mm screws
- 49" model VESA 200 x 200, M6 x 12mm screws
- 50" model VESA 200 x 200, M6 x 12mm screws
- 55" model VESA 200 x 200, M6 x 12mm screws
- 65" model VESA 400 x 200, M6 x 12mm screws

The VESA number is the horizontal and vertical measurement of the mounting holes.

For example, 100 x 200 indicates that the mounting holes are spaced 100mm horizontally and 200mm vertically.

Follow the directions supplied with the wall mount to mount the TV to the wall.

Caution: Your wall mount must be able to bear a minimum of five times the TVs net weight to avoid damage.

Note: The wall mount bracket and the screws are not included

To use the stand

- Your TCL Roku TV comes without the stands attached so that you can choose to use the stands or mount your TV to a wall using a wall mount (sold separately). If you want to mount your TV to the wall, don't attach the stand legs.
  - A – Place the TV face down on a soft, cushioned surface on a table. The bag the TV was packed in makes a good cushion. Position the TV so that the stand, when attached, will hang over the edge of the table.

- B – Take out the two plastic covers from the stand holes at the bottom of the TV.

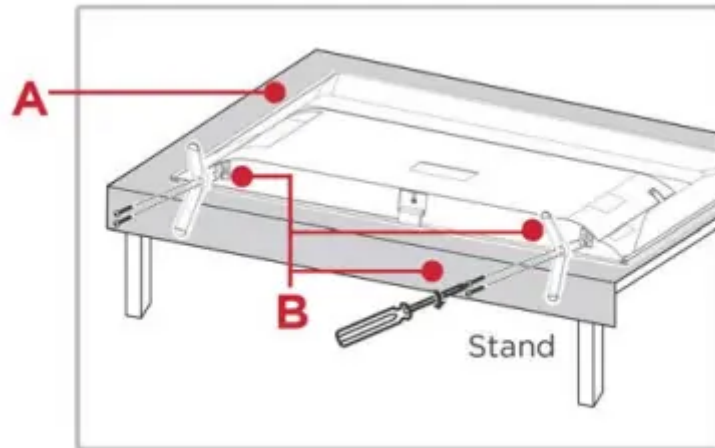

- C – Put the column of the stands into the TV, align the stands with the screw holes located on the TV.
- D – Secure the stands to the TV with four (4) screws.

Refer to your TV's Quick Start Guide or other provided documentation to for modelspecific information about attaching the base or a wall mount and making connections to AC power and to your other audio/video devices. The following information applies to all TCL Roku TV models

### **Connecting an antenna, cable, or satellite box**

- If you are using an antenna, CATV cable without a set-top box, or a cable or satellite box that has only an antenna output, connect a 75-ohm coaxial cable (not provided) from the device to the ANT/CABLE input on the TV.
- Tip: If you are using an antenna with a 300 ohm twin-lead cable, you need to use a 300-to-75 ohm adapter (not provided) to adapt the twin-lead cable to a connection that is compatible with the TV's antenna input.
- Tip: If you receive your TV stations through a set top box from a cable or satellite TV provider, connect it to the TV using the best connection method available. From most to least desirable:
  - HDMI® input – Digital HD and SD video
  - AV input – analog SD video
  - Antenna input – analog SD video using NTSC



## Connecting external equipment with a composite AV video cable

- If the best connection available on your device is AV or composite video output, connect it to the TV using a composite AV cable (not provided).
- Composite AV cables typically have three RCA-type plugs on each end, color coded as follows:
  - Yellow – Video
  - Red – Audio, right channel
  - White or black – Audio, left channelConnect each plug to the corresponding connector on the device and on the TV.
- Note: Select models have an AV Input that looks like a headphone jack. Use the breakout cable (included) to adapt this input to the three RCA-type plugs on your composite cable.

## Connecting external equipment with an HDMI® cable



- If possible, connect your devices using HDMI® cables (not provided). They help to provide the best video quality and also carry audio signals, so that only one cable is needed. For better picture quality, we recommend that you use cables designated as High Speed HDMI® Cables.
- Tip: You might need to configure the device to send its signal through its HDMI® connector.
- The connector labeled HDMI IN (ARC) has the additional ability to use the audio return channel to send digital audio to a receiver or sound bar, as explained in Connecting an AV receiver or digital sound bar.

## Connecting headphones or analog sound bar to the TV

- You can connect headphones or an analog sound bar (not provided) to the TV's headphone jack.
- Tip: Inserting a plug in the headphone jack disables the sound from the TV's built-in speakers.
- Warning: Loud noise can damage your hearing. When using headphones, use the lowest volume setting on your headphones that still lets you hear the sound.

- Select models also have an audio line out connection that is not affected by TV volume or mute settings and does not disable the TV speakers. Use this connection when you want to use your amplifier or sound bar to control the TV volume. To turn off the TV's built-in speakers, in the Home screen menu, navigate to Settings > Audio > TV speakers and change the setting.



### Connecting an AV receiver or digital sound bar

You can enjoy Dolby Audio™ multichannel sound from your TV if you connect a digital amplifier or sound bar (not provided) in either of two ways:



- Digital optical audio out (S/PDIF) – Connect a TOSLINK optical cable (not provided) from the TV to the Optical input on your receiver or sound bar.
- HDMI® ARC – Connect an HDMI® cable (not provided) from the HDMI (ARC) connector to the HDMI® input on your receiver or sound bar. This connection uses the Audio Return Channel (ARC) feature of the HDMI® specification to output sound from the TV to

a compatible device. To use this feature, you must configure the TV to enable HDMI® ARC, as explained in Enable HDMI® ARC.

## Preparing for Internet connectivity

- If you want to watch streaming content and take advantage of the cool features of your TCL Roku TV, connect it to the Internet through a wireless modem/router or a wireless access point (not provided). The TV has a built-in wireless LAN adapter.
- Note: The TV supports only its internal wireless network adapter—it does not support the use of a USB network adapter.
- Select 4K models have wired in addition to wireless network connectivity. To use the wired network connection, connect an RJ-45 Ethernet cable (not provided) from the jack on the back of your TV to your network router or switch. The wired connection supports both 10 Base-T and 100 Base-T Ethernet.

### AC power

- Plug your TV into a power outlet. You can tell that the TV has power because the status indicator lights up when the TV is off.
- The topic Status indicator explains how the status indicator shows what is happening with the TV.

## Guided Setup

With the preliminaries out of the way, it's time to turn on your TV. As the TV starts for the first time, it leads you through Guided Setup, which configures the TV before you start to use it.

During Guided Setup, you'll:

- Answer a few questions
- Provide network connection information
- Get a software update
- Link your TV to your Roku account.
- Connect devices such as a DVD player, game console, or cable box.

## Starting Guided Setup

- To start Guided Setup, press the POWER button on the remote to turn on your TV.
- Note: Guided Setup normally runs only once, the first time you turn on your TV. If you need to run Guided Setup again, you'll have to perform a factory reset, as explained in Factory reset everything.

- When you first turn on your TV, it will take a few seconds to get itself ready. You'll notice the following things happening:
  1. The status indicator blinks every time the TV is busy doing something; in this case it's powering up and getting ready for you.
  2. The power-on screen appears and the status indicator blinks slowly for a few more seconds. The power-on screen shows a brand logo while the TV starts up.
  3. After a few seconds, Guided Setup starts

## Completing Guided Setup

Follow these steps to complete Guided Setup. At this point, you should be seeing the Language screen.



1. Only on models that have a Roku voice remote: A few moments after the Let's get started screen appears, Guided Setup starts the pairing process for the voice remote. (You'll know if you have this type of remote because it will have microphone or search button just below the down arrow on the purple pad.) If the voice remote does not pair automatically, follow the instructions on the screen to complete the pairing process.

Tip: On TVs sold in the United States, if you are blind or visually impaired, you can activate Audio Guide, a text-to-speech screen reader to help you navigate the TV's menus and commands. To enable the Audio Guide, press the P button on the remote four times in rapid succession. Repeat to disable Audio Guide. (The P button is located directly below the directional pad on the right side of the Roku remote.)

Note: If you enabled Audio Guide, choosing any language other than English disables it.

2. Press the DOWN arrow on the remote to highlight your preferred language, and then press OK or the RIGHT arrow.

3. Some models have a country selection screen: If you don't see this screen, skip ahead to the next step. If you see this screen, select your country



Note: If you enabled Audio Guide, choosing any country other than United States disables it.

4. Press OK or the RIGHT arrow on the remote to go to the next screen:



Note: Some models show the title First things first instead of Set up environment.

5. Press OK to select Set up for home use. This is the right choice for enjoying your TV at home. It provides energy saving options as well as access to all features of the TV.

Note: Store mode configures the TV for retail display and is not recommended for any other use. In store mode, some features of the TV are missing or limited. To switch from one mode to the other, you have to perform a factory reset as explained in Factory reset everything, and then repeat Guided Setup

**Network connection:** After you select Set up for home use, the TV prompts you to make a network connection. If your TV has both wired and wireless connections, you'll see the following screen.

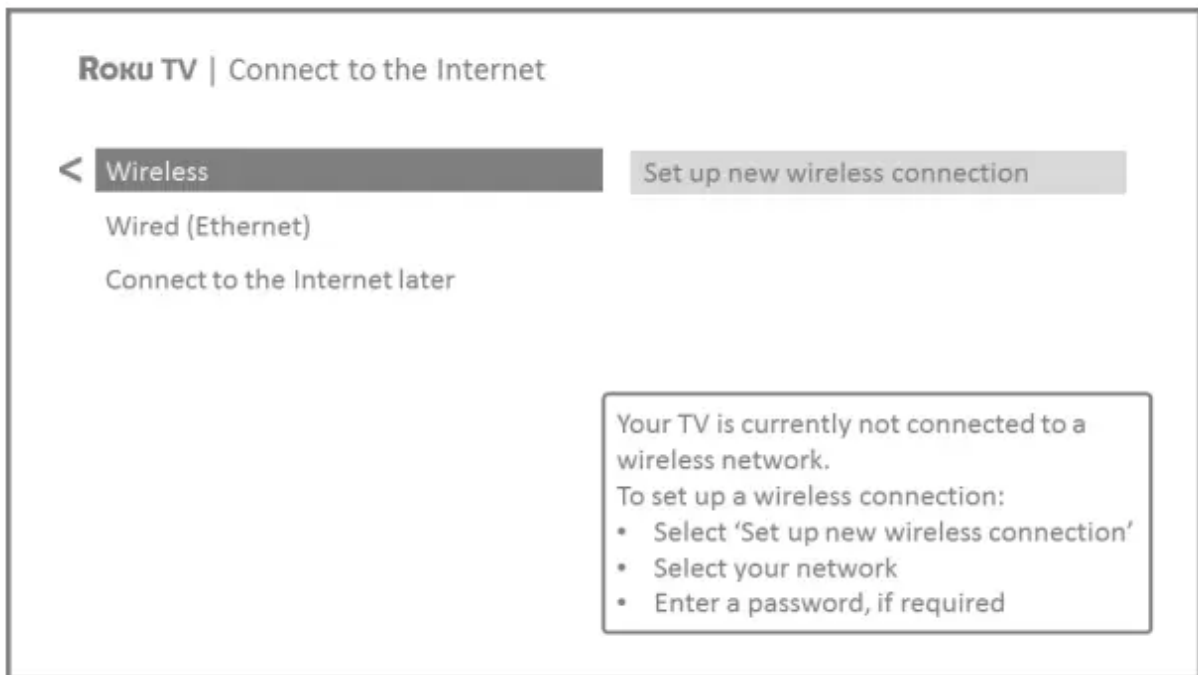

6. Only models that display the Connect to the Internet screen: Make a selection:

- Wireless connection – Highlight Set up new wireless connection and press OK. The TV prompts you through wireless setup. Skip ahead to the next step for help with the process.
- Wired connection – Highlight Connect to wired network and press OK. The TV immediately attempts to connect to your wired network, your local network, and then the Internet. Go to Step 9 to continue with Guided Setup.
- Connect to the Internet later – If you don't want to connect to the Internet right now, you can skip this step and use the TV to watch Antenna TV channels, play games, and watch DVDs. When you're ready to connect, it's easy. We'll show you how in Benefits of connecting.

Note: If you decide not to connect, Guided Setup skips ahead to setting up the devices that you've connected to your TV. Jump ahead to Connect your devices to complete Guided Setup.

7. On models that have wireless only, or models with both wired and wireless and you've selected Wireless: The TV scans for the wireless networks within range and displays them in order, with the strongest signals first. In addition to your own wireless signal, the TV might pick up signals from your neighbors.

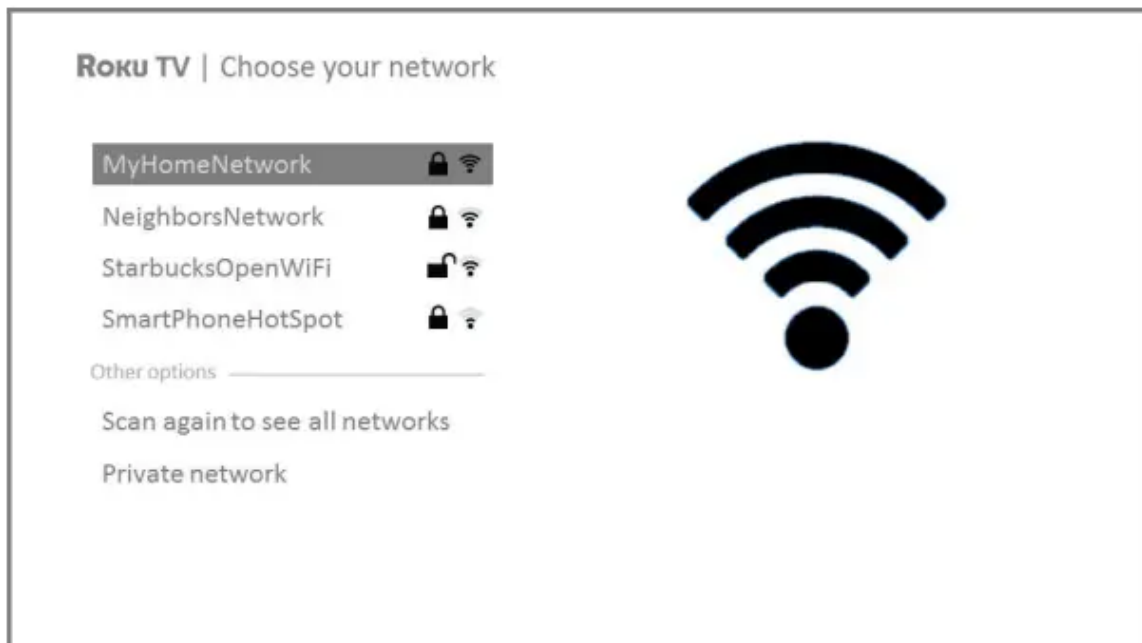

Press the UP or DOWN arrows to highlight the name of your wireless network, and then press OK to select it.

Note: Some networks, such as those often found in dorm rooms, hotels, and other public places, require you to read and agree to terms, enter a code, or provide identifying information before letting you connect to the Internet. If your TCL Roku TV detects that you are connecting to such a network, it prompts you through the connection process using your compatible smartphone or tablet to provide the needed information. For more information, see [Using your TV in a hotel or dorm room](#)

### Other options

- Connect to the Internet later – If you don't want to connect to the Internet right now, you can skip this step and use the TV to watch Antenna TV channels, play games, and watch DVDs. When you're ready to connect, it's easy. We'll show you how in [Benefits of connecting](#). Note: If you decide not to connect, Guided Setup skips ahead to setting up the devices that you've connected to your TV. Jump ahead to [Connect your devices to continue](#).
- Scan again / Scan again to see all networks – The name of this option depends on the number of wireless networks within range.
  - Scan again appears if the list already shows all available wireless networks within range. If you don't see your wireless network name in the list, you might need to adjust the location of your wireless router or the TV, turn on your router, or make other changes. When everything is ready, select Scan again to see if your network name now appears in the list.

- Scan again to see all networks appears if there are more wireless networks than the strongest ones it initially listed. If you don't see your wireless network name in the list, this option displays the complete list. If you still don't see your network name, you might have your router configured to provide wireless service as a "private network."
- Note: Highlighting either of these options displays an informational panel with the unique media access control (MAC) address of your TCL Roku TV. You will need the MAC address if your wireless router is configured to use MAC address filtering don't see your network name, you might have your router configured to provide wireless service as a "private network." Note: Highlighting either of these options displays an informational panel with the unique media access control (MAC) address of your TCL Roku TV. You will need the MAC address if your wireless router is configured to use MAC address filtering
- Private network – If your wireless network name is hidden, it won't appear in the list. Select Private network to display an on-screen keyboard, and use it to enter your network name. Unless you changed the factory-set network name, you can find the name (also called SSID) on a label on the router. Tip: Wireless networks that are password-protected display a "padlock" icon adjacent to the name. This icon enables you to know that you are going to be prompted to enter a password after you select that network



8. Only if you select a password-protected wireless network: An on-screen keyboard appears. Use the keyboard to enter the network password.

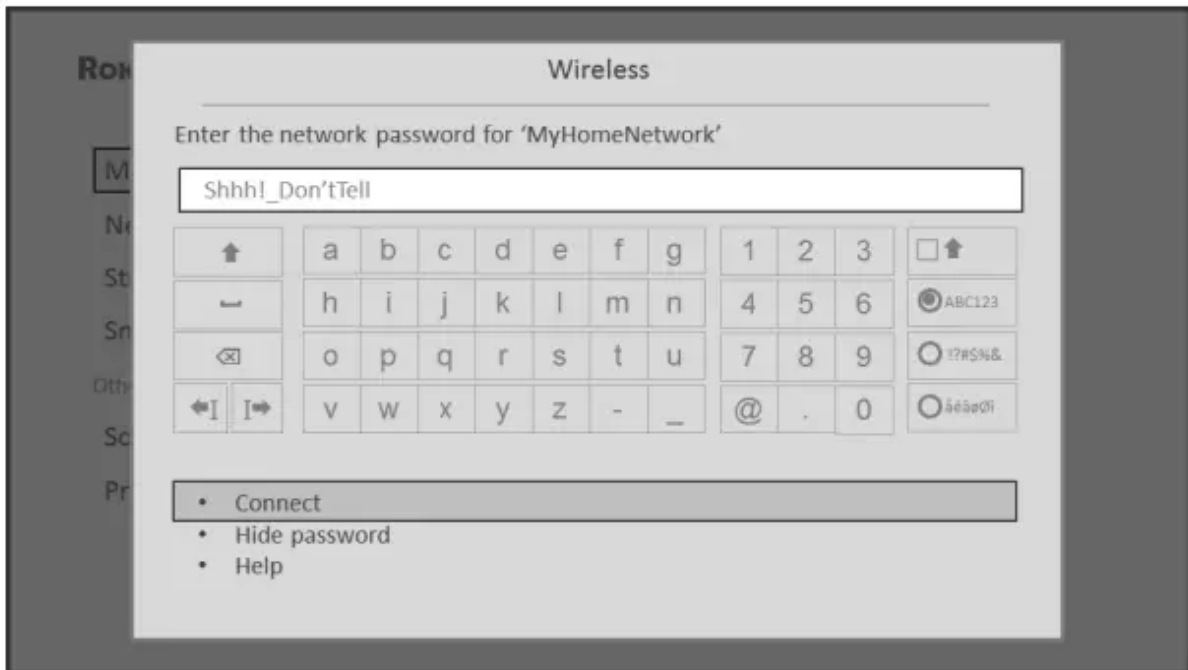

After you submit your wireless network password, the TV displays progress messages as it connects to your wireless network, your local network, and the Internet

9. Only if your TV cannot get the correct time zone and current time from your network service provider: Use the UP and DOWN arrows to highlight your time zone, and then press OK.

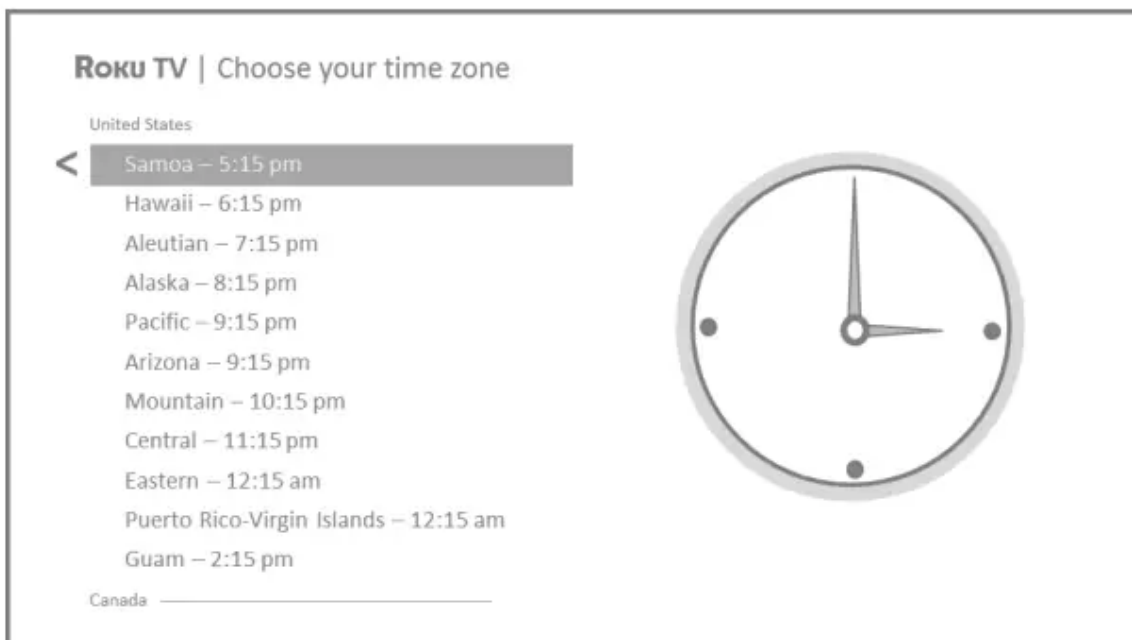

- Tip: Your TV needs to know the local time zone so that it can correctly display information about the program you are currently watching. If the TV is unable to

automatically determine the local time zone, it prompts you to choose your time zone from a list.

- As soon as the TV is able to connect to the Internet, it downloads and installs its first software update, and then restarts.
- Tip: Your TV automatically checks for updates periodically. These updates provide new features and improve your overall experience with the TV. After an update, you might notice that some Options have moved and that there are new options or features. This User Guide describes version 8.0. To determine your current TCL Roku TV software version, go to Settings > System > About after you complete Guided Setup. You can download an updated User Guide that matches your TCL Roku TV software version from the TCL Roku TV website

## Activation

After the TV restarts, it displays the Activation screen:

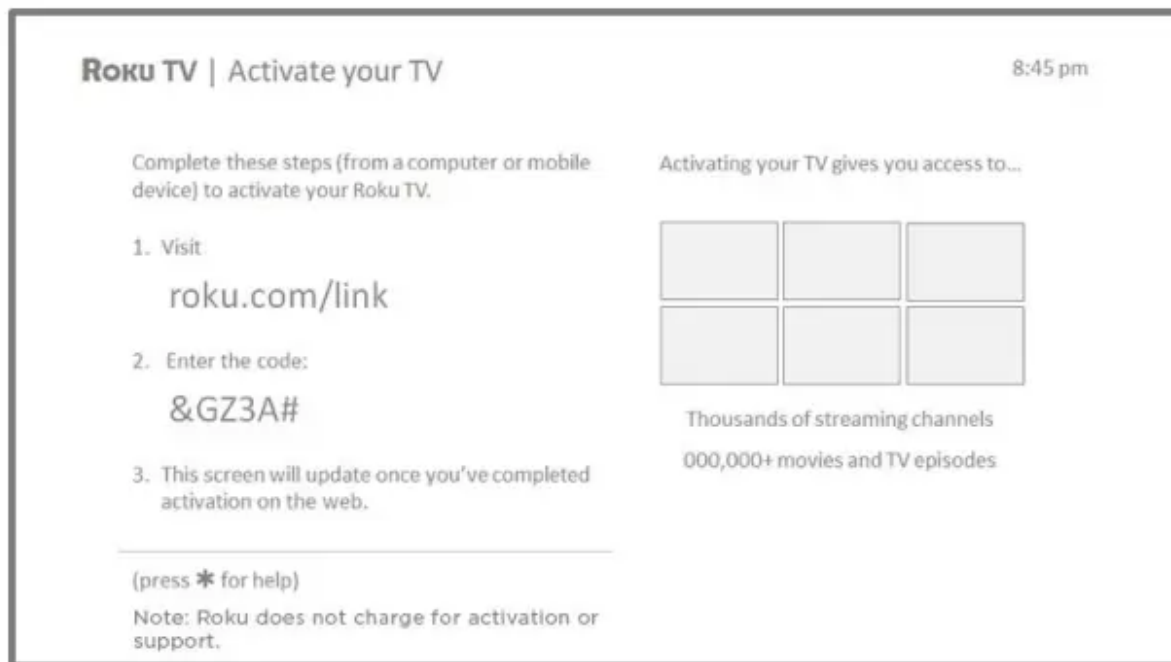

10. Using a compatible computer, tablet, or smartphone with an Internet connection, go to the web address displayed on the screen and enter the code that appears on your screen

*Why do I need a Roku account?*

You need a Roku account for several reasons:

- It links you, your TCL Roku TV, and your other Roku streaming devices to the Roku Channel Store and billing service.
- Streaming content providers know that it's OK to send content you request to your TCL Roku TV.
- Roku can automatically send updates to your device.

You need a Roku account to activate your device and access entertainment across thousands of streaming channels. Roku accounts are free, and while a valid credit card number is not required to create your account, providing your credit card information makes renting and purchasing entertainment from the Roku Channel Store fast and convenient.

After you log in or create your Roku account, the link page suggests that you select some streaming channels. After you confirm your selections, the TV gets an acknowledgment, and then adds your preexisting and newly-selected streaming channels to your TCL Roku TV. This process is automatic and takes a few moments—a little longer if you already have a lot of streaming channels to add.

Tip: Streaming channels from all Roku streaming devices associated with your account are synchronized periodically so that all of your Roku streaming devices have the same set of streaming channels (subject to compatibility with the device).

### **Connect your devices**

Next, Guided Setup helps you set up the external devices that you want to use with it, such as a cable box, Blu-ray™ player, or game console.

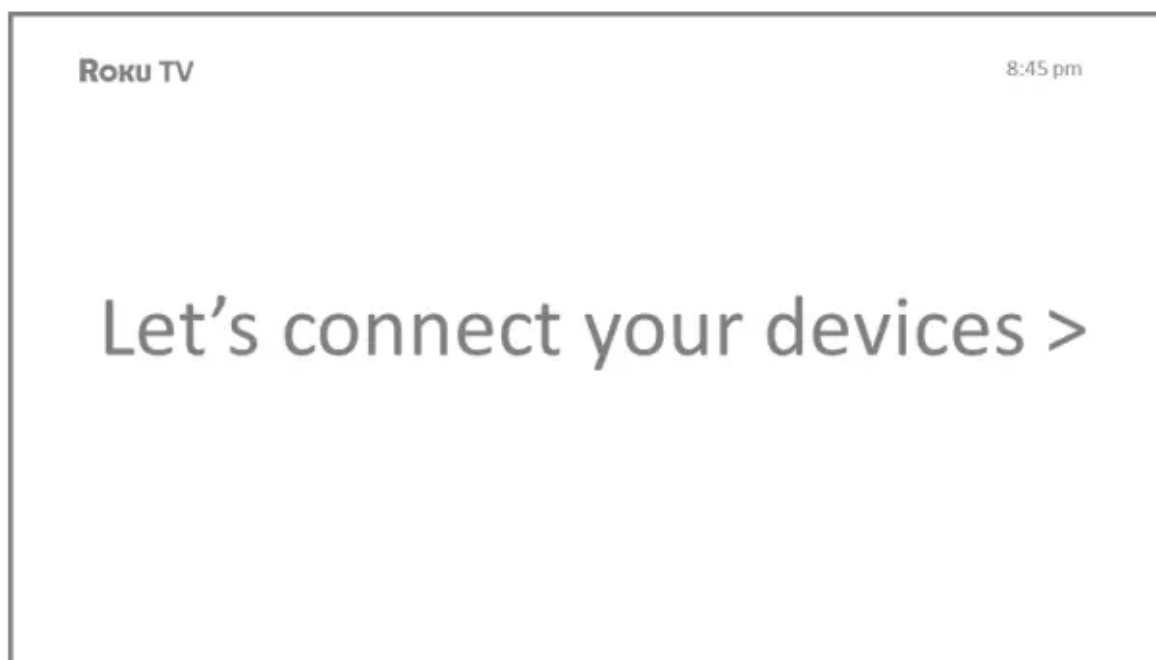

11. Press OK or the RIGHT arrow to proceed:

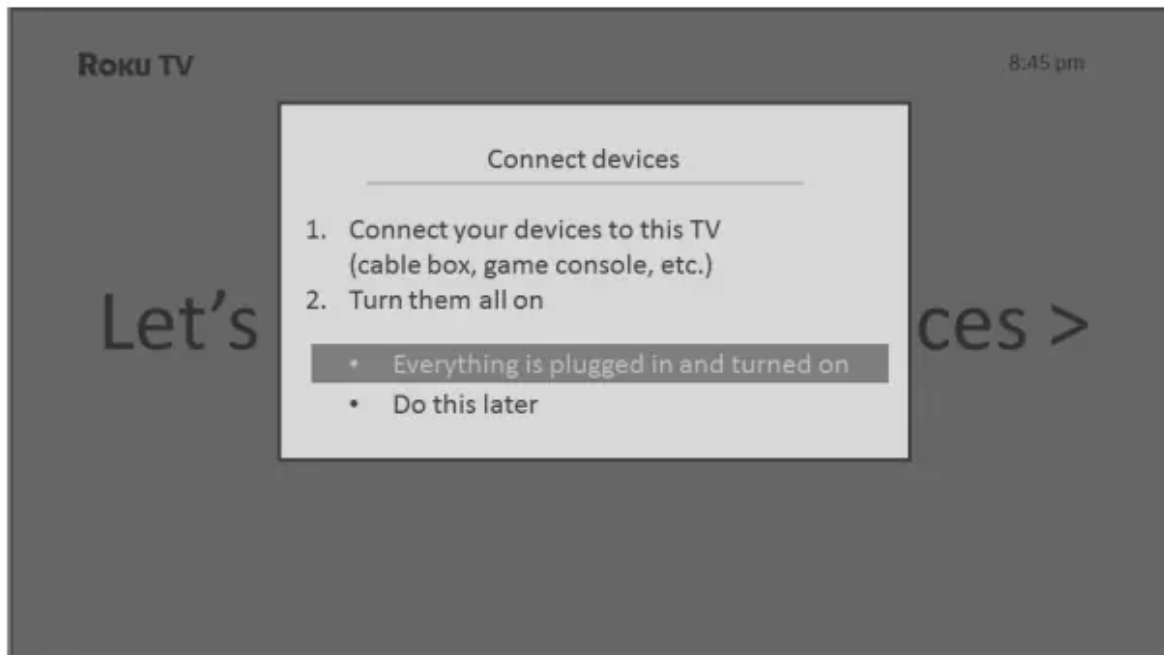

12. Connect all the devices you plan to use with your TV, turn them all on, and then select Everything is plugged in and turned on. The TV now takes you step by step through each of its inputs and asks what kind of device you have connected. On each input that has a connected and active device, you can see its picture and hear its sound.

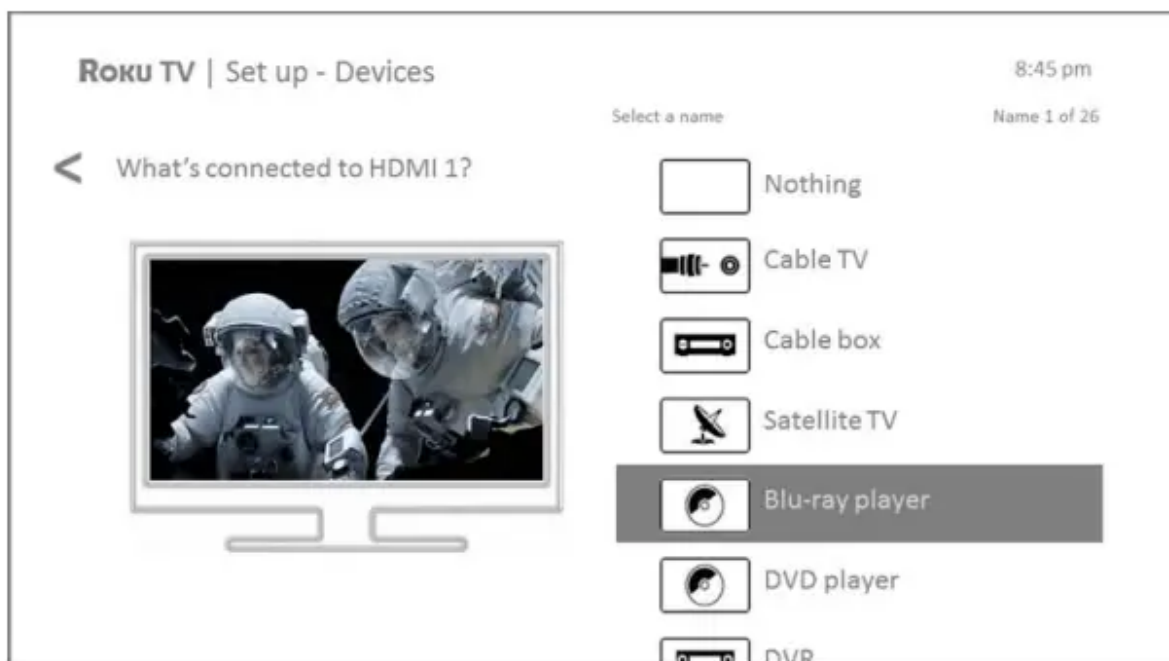

13. Press the UP or DOWN arrows to highlight the label you want to associate with the input. If you are not using the input, select Nothing, and the input won't appear on the Home screen.

14. While setting up your devices, rather than using the predefined names and icons, you can set a custom name and icon. To do so, scroll up or down to highlight Set custom name &

icon, and then press OK. Follow the instructions on the screen to enter a name and select an icon for the input. See Rename inputs for more information.

Note: If you have renamed the inputs, you cannot use voice commands to switch inputs. Voice commands can only switch among inputs that have their original names, such as “AV,” and “HDMI 1.”

15. Repeat the previous step for each input. You’re done with Guided Setup.

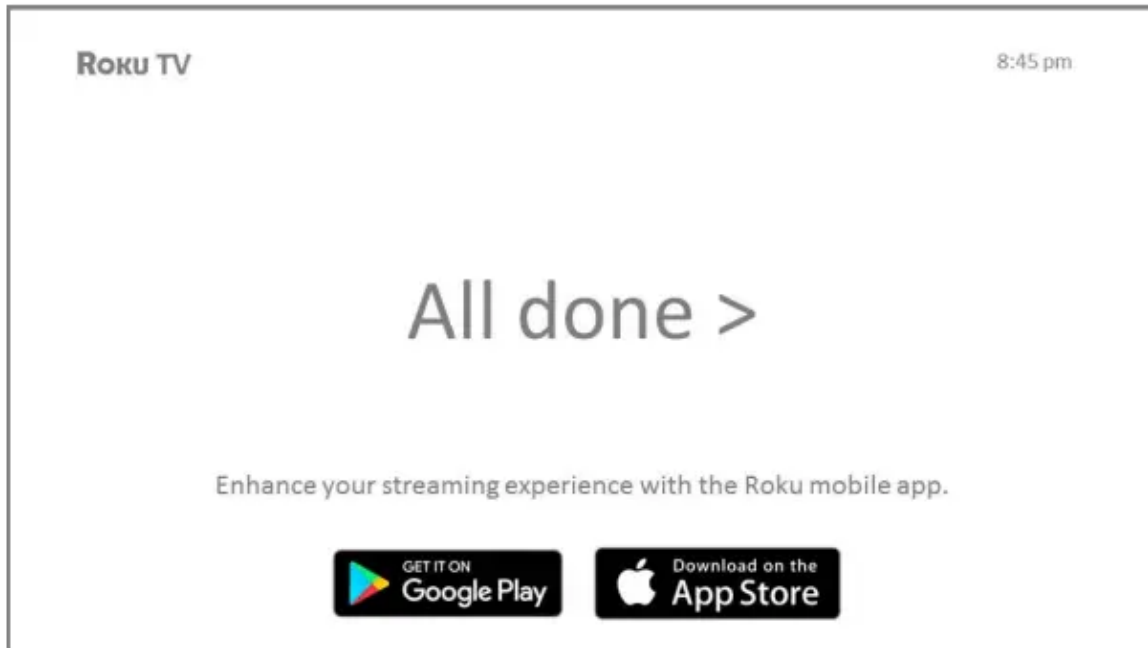

Note: Some TCL Roku TVs, depending on where you live and other factors, show you an introductory video filled with some great hints and tips. If you’re not interested in viewing this video,

press  on the remote to return to the TCL Roku TV Home screen.

Whenever you press  on the remote, the Home screen greets you.

From here, you can explore everything your TV has to offer. Press the arrow keys to move around, and press OK to select a highlighted item. We’ve designed the TV to encourage you to explore, and you can probably figure out most of the capabilities and settings on your own. If you have any questions or difficulties, you can find answers and solutions in this guide.

## Benefits of connecting

### Connecting brings out your TV's full potential!

- Make any night a movie night:; Thousands of movies to choose from, across all major streaming movie channels like Netflix, Crackle, and more\* . You'll never run out of something new to watch.
- Get in the groove: Stream endless hours of music from free and subscription-based channels like Deezer and TuneIn. With almost instant access to thousands of music artists, your favorite beats are just as close as your remote.
- Explore your passions: In addition to popular streaming channels like YouTube, NHL, Sky News, and Google Play, your TCL Roku TV also offers hundreds of streaming channels to fuel your passions—including fitness, cooking, religion, outdoors, International programming and much more.
- Enjoy FREE trials of popular channels: Your TCL Roku TV comes loaded with special offers, including free trials (if eligible) from popular streaming channels like Netflix, Hopster, Acorn TV, and many more. REMEMBER THAT YOU MUST CANCEL BEFORE THE FREE TRIAL ENDS TO AVOID SUBSCRIPTION FEES.

\* A paid subscription or other payments may be required for some channels. Channel availability is subject to change and varies by country. Not all content is available in countries or regions where Roku® products are sold.

### Take advantage of awesome features

- Powerful, voice-enabled search helps you find movies and TV shows, actors, or directors across multiple streaming channels. Search results also includes Antenna TV programs airing in your region as well. Voice Search and Antenna TV search results are available only in the United States.
- Smart Guide is an electronic program guide that is available any time you are watching "over-the-air" TV programs on the Antenna TV input. You can scroll up and down to see all Antenna TV channels you receive. You can scroll left to see the previous 7 days' programs, and scroll right to see the upcoming 14 days of programs. If you highlight a show that has a purple asterisk (P), you can press the P to see More Ways to Watch. And your most-watched channels are automatically grouped into a Favorites section at the top of the Smart Guide.
- More Ways to Watch (U.S. only) gives you recommendations about the show you are watching on the Antenna TV, HDMI, or AV input, gives you options to stream the current show from the beginning, the entire season, or the entire series, and recommends other shows with similar themes. It also uses the shows you watch to display ads that are more relevant to you.

- Live TV Pause lets you connect a USB drive (not provided) and pause live TV for up to 90 minutes. After pausing, you can play, fast-forward, rewind, and pause again to any point within the rolling 90-minute window.
- Voice commands let you use your Roku Voice Remote, Roku Enhanced Voice Remote, or the Roku mobile app to change stations, TV inputs, and launch streaming channels, and more. Voice commands are available only in the United States.
- Mobile Private Listening on the Roku mobile app lets you listen to streaming programs and “over-the-air” TV shows from the Antenna TV input on headphones (not provided) plugged into your IOS® or Android™ mobile device.

## What is streaming?

Streaming is viewing or listening to video or audio content that is sent over the Internet, or located on a network-connected media server or on a USB device plugged into the TV’s USB port.

With streaming, you can buy or rent most programs on demand, when it’s convenient for you. When streaming, you can play, pause, rewind, and fast-forward most of what you are watching. You can also replay the last few seconds again, or turn on closed captions.

Tip: Some content cannot be paused or skipped. For example, if you are viewing live programming or a program that is supported by ads, you might not be allowed to skip the ads.

Your TCL Roku TV lets you choose from thousands of streaming channels that offer a huge selection of entertainment:

- Thousands of movies and TV episodes
- Unlimited music, live and on-demand
- Tons of live and on-demand sports
- Commercial-free kids programming
- International programming in 22 languages
- 24x7 news and in-depth news commentary

Many streaming channels are free. Some streaming channels, like Google Play, let you purchase or rent the latest movie releases or popular TV series. Some channels such as Netflix or Acorn TV charge a monthly subscription fee and others are available at no additional cost if you subscribe to a companion service through your cable or satellite provider.

If you have an existing subscription to a service like Netflix, you can just sign in with your existing user name and password.

To play streaming content, you add streaming channels to your Home screen. Use the Streaming Channels option on the Home screen menu to go to the Roku Channel Store, and then select the streaming channel you want to add. The channel remains on your Home screen unless you remove it, and you can watch it at any time.

For more information on using the Roku Channel Store feature, see [Using the Roku Channel Store](#).

Note: A paid subscription or other payments may be required for some channels. Channel availability is subject to change and varies by country. Not all content is available in countries or regions where Roku® products are sold.

## What if I didn't connect my TV?

What if you went through Guided Setup and chose Connect to the Internet later? No worries. Your TCL Roku TV makes it easy to connect whenever you want. As you move around the Home screen, you'll see several places where you can start the connection process. For example:

- Now and then you'll see a message appear on the panel to the right of the Home screen offering a Connect Now option. Simply highlight and select the Connect Now option to get started.
- Use the Connect and activate now option in the Settings menu. From the Home screen menu, select Settings, then Network, and then Connect and activate now.
- If you want to start over from the beginning, use the Settings menu to do a Factory reset, and then go through Guided Setup again. This time, choose your home network when prompted.

## Using your TV

This section provides information on using the day-to-day features of your TV.

### Status indicator

Your TV has a single status indicator. It goes on and off and blinks in different ways depending on the status of the TV, as shown in the following table:

#### TV CONDITION -- STATUS INDICATOR -- MEANING

1. On (screen is active) - Off - Screen is communicating that TV is on.
2. Screensaver (screen is active) - Off - Screen is communicating that TV is on.
3. Off (no power) - Off - TV is not connected to power.
4. Off (standby) - On - TV is connected to power and is ready to use.
5. Starting up from off state - Slow pulsing blink until startup completes - TV is doing something.
6. On (receiving update from USB) - Slow pulsing blink until update completes - TV is doing something.
7. Remote command received - Dims on/off once - TV has received your command.

8. Network connection lost - Two short blinks, pause, repeat - TV was connected and paired with a Roku account and now has no network connection.
9. Powering down to standby mode - Slow pulsing blink until the TV reaches standby. - TV is doing something

## Standby mode energy savings

- When you turn off your TV, it remains in a higher power mode for a few minutes, after which it goes into a very low-power standby mode. If you turn on the TV again before it has entered the very low power mode, it turns on immediately. After the TV goes into the lower power standby mode, it takes a few seconds longer to start up.
- Only in connected mode on TVs that do not have an Energy Star® rating, you can optionally enable Fast TV start. When this option is enabled, your TV starts up almost immediately regardless of how long it has been turned off, but uses somewhat more power in standby mode. For more information, see Fast TV start.

## Opting in to Smart TV experience (U.S. only)

- Only in connected mode in the United States, the first time you select Antenna TV, an HDMI input, or AV input, your TV offers to enable the Smart TV experience. If you decide to enable it at this time, you're all set to enjoy its recommendations and features.

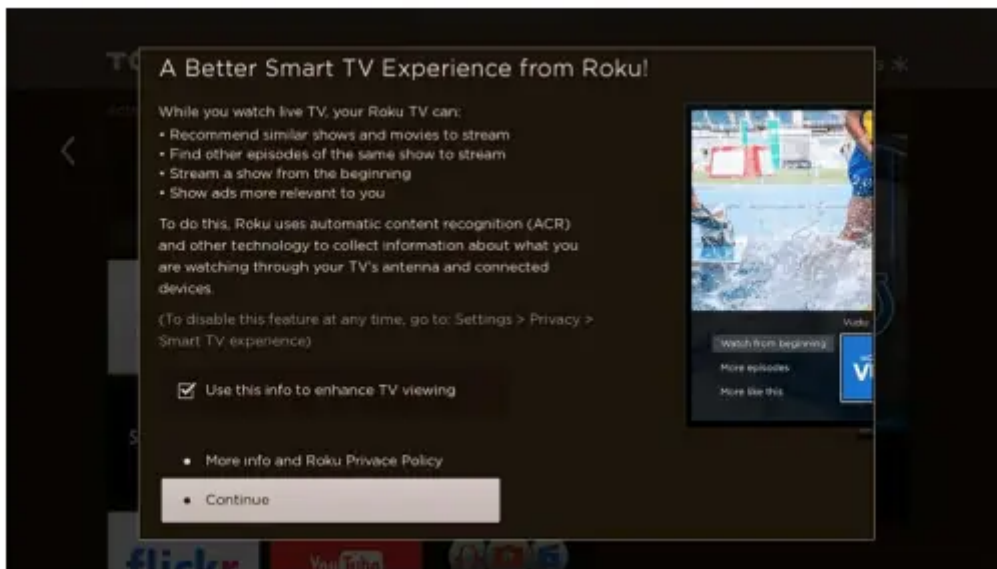

- The Smart TV experience uses automatic content recognition (ACR) and other technology to collect information about what you watch through your Antenna TV, and on devices like media players and cable boxes connected to the HDMI or AV inputs. Opting in means that you give permission to analyze the programs you watch for the purpose of making recommendations, as well showing ads that are more relevant to you.

- If you decide not to enable the Smart TV experience at this first opportunity, you can enable it later. Or, if you decide you'd rather not use the feature, you can disable it, but be aware that previously collected information is retained and not deleted.

## Disable Smart TV experience

If you decide you want to disable Smart TV experience, follow these steps:

1. From the Home screen, go to Settings > Privacy > Smart TV experience.
2. Navigate to the right to highlight Use info from TV inputs.
3. Press OK on the remote to clear the check box.

## Disable Auto Notifications

If you want to keep the Smart TV experience enabled, but you do not want to see notifications while you are watching shows, you can disable notifications. To do so, follow these steps:



1. From the Home screen, go to Settings > Privacy > Smart TV experience.
2. Navigate to the right to highlight Use info from TV inputs.
3. Press DOWN on the remote to highlight Enable auto notifications.
4. Press OK on the remote to clear the check box.

Note: These settings do not affect recommendations for More Ways to Watch that you see in the Smart Guide when watching Antenna TV channels. Those recommendations come from the Smart Guide and do not rely on ACR technology.

## Watching Antenna TV channels

Select the Antenna TV tile in the Home screen. Your TV remembers the last channel you watched and starts with that channel playing.

Changing channels: To change channels, you can do any of the following:

- Press the UP arrow to change to the next higher channel.
- Press the DOWN arrow to change to the next lower channel.
- Press the LEFT arrow to display the channel list (in non-connected mode) or Smart Guide (in connected mode), and then press the arrow keys to select the channel or show you want to watch. Press REWIND and FAST FORWARD to move through the list one page at a time. When you've highlighted the channel or show you want to watch, press OK. (If you decide you don't want to change channels, press the BACK button).
- Only if Live TV Pause is not enabled, press  to jump to the previous channel. Press  again to return to the channel you were watching before you pressed .

Note: If the  button is not available on your remote, you can use this feature in the Roku mobile app. For more information, see Getting and using the Roku mobile app

## Favorite Channels in non-connected mode

- You can quickly change from surfing among all channels or only your favorite channels. First, you have to mark one or more channels as your favorites.
- Note: In the United States, in connected mode, favorite channels appear at the top of the Smart Guide automatically after several days of watching Antenna TV channels. For details, see Smart Guide.

Mark your favorite channels: In non-connected mode, you can make any channel a favorite whenever you're watching Antenna TV channels.

1. Press the LEFT arrow to display the channel list. Notice that the words All channels appear at the top of the channel list.
2. Scroll up or down to highlight a channel that you want to make a favorite.
3. Press \* . At this point, you'll see two options:
  - Add to favorites
  - Back

4.

With Add to favorites highlighted, press OK. A  symbol appears adjacent to the channel to indicate that it is now a favorite.

5. Repeat these steps to add more favorite channels.

## Surf only your favorite channels

In non-connected mode, after you've marked one or more channels as favorites, you can switch to your favorite channels whenever you're watching Antenna TV channels.

1. Press the LEFT arrow to display the channel list.
2. Press the LEFT or RIGHT arrow once to switch to Favorites. Notice that the word Favorites appears at the top of the channel list.
3. Highlight a channel and press OK to select one of the channels in the Favorites channel list, or wait a few moments until the channel list disappears.
4. Press the UP or DOWN arrow to change to the previous or next favorite channel. Each channel you select in this way is a favorite channel. Your channel surfing is limited to favorite channels only.

Your favorite channel list remains in effect even if you turn off or unplug your TV, until you switch back to all channels.

Note that when you press OK to view the program information banner while watching a show, a



symbol appears below the channel number.

## Surf all channels again

In non-connected mode, you can switch back to all channels whenever you're watching Antenna TV channels.

1. Press the LEFT arrow to display the channel list.
2. Press the LEFT or RIGHT arrow once to switch to All channels. Notice that the words All channels appear at the top of the channel list.
3. Highlight a channel and press OK to select one of the channels in the All channels list, or wait a few moments until the channel list disappears.
4. Press the UP or DOWN arrow to change to the previous or next channel among all your available channels. You can surf among all channels in your channel list.

## Remove a channel from your favorites

In non-connected mode, you can remove a channel from your favorites whenever you're watching the Antenna TV input.

1. Press the LEFT arrow to display either channel list—All channels or Favorites.
2. Scroll up or down to highlight a favorite channel that you want to remove from your favorites.
3. Press **P** on your remote. At this point, you'll see two options:
  - Remove from favorites
  - Back
4. With Remove from favorites highlighted, press OK. The  symbol adjacent to the channel disappears.
5. Repeat these steps to remove other channels from Favorites

## Searching for something to watch

Searching for movies and shows across both Antenna TV (only in the United States) and streaming channels is one of the unique features of your TCL Roku TV. Within a single search operation, you can search by:

- Movie name
- TV show name

- Actor or director name
- Streaming channel name
- Game name

Note: Roku Search is not available if your TV is operating in non-connected mode. Roku Search doesn't search across all streaming channels, but searches across lots of popular streaming channels. The actual channels it searches vary by locale.

## How do I search?

- You can search by using an on-screen keyboard that you navigate using the arrow keys on your remote, or only in the United States, you can use a Roku voice remote or the Roku mobile app to search with your voice.



## Keyboard search using the remote

1. Select Search on the Home screen menu. The Search screen has a keyboard grid and initially displays instructions—a set of icons representing search categories and a list of participating provider tiles. Tip: If you don't see the instructions, navigate to the end of the list of recent searches and select Clear recent search selections.
2. Use the arrow keys to navigate the on-screen keyboard, entering a few characters of the search term. With each additional character you enter, you narrow down the search, making the search results more relevant. You'll often see the results you are seeking after entering only a few letters.
3. When you see the show you are searching for, navigate to the right to highlight it.

## Voice Search from a Roku voice remote

Only in the United States with models that have a Roku Voice Remote or Roku Enhanced Voice Remote:

1.

Press and hold the search button, either  or .

2. Say the name of a movie, TV show, actor, or director. The TV lists the results of your search across many streaming and Antenna TV channels. An icon next to each search result shows the category of the result (movie, TV show, actor).
3. Press the RIGHT arrow to move the highlight into the list of search results.
4. Press the UP and DOWN arrows to scroll through the list of search results to highlight the item you want to view.

## Searching from the Roku mobile app

- Use the free Roku mobile app on your compatible smartphone or tablet to make searching even faster. Use your mobile device's keypad to type more quickly and easily than with the on-screen keyboard on your TV. Only in the United States, you also can search simply by touching the Voice Search icon and saying the name of the movie, TV show, actor or director, streaming channel, or game.
- When you use the Roku mobile app to search, search results are shown on your mobile device instead of on the TV screen. When you make a selection from the search results, the TV starts playing the selected program

## I found a show, now what?

- Now that you've highlighted the show, movie, actor, game, or streaming channel you were looking for, press the RIGHT arrow.
- If your search result was an actor, director, or other item that does not represent a single item of content, you'll see another list to narrow down your search. Continue highlighting results and pressing the RIGHT arrow until you find a single, viewable content item.



- The channel logo appears to the left of each result.
- Only in the United States, a LIVE TV logo indicates a program that is available on Antenna TV. Shows currently playing live appear at the top of the list. Shows airing in the future appear at the bottom of the list. Selecting a LIVE TV result switches the TV to that channel regardless of whether the program is currently in progress.
- An HD logo means that the content is available in high-definition.

- The checked circle adjacent to the title means you have already added the streaming channel.

If your search result was a game or a streaming channel, you'll see detailed information, images, and available actions, such as a list of streaming channels and the cost of getting the item or channel.

Note: Some channels may require a paid subscription.

## Follow on Roku

- Rather than watch the show you found in Search, you can add it to My Feed and wait until it's available on a particular streaming channel or available at a better price. From the search results screen, select Follow on Roku. Then go to My Feed periodically to check for updates to each of your followed movies, TV shows, or people. For more information, see My Feed.

## Recent Searches

- The next time you use Roku Search, the Search screen displays a list of recent search selections in place of the search instructions.
- Using the recent search selections list makes it easy to quickly get to a previously found item, for example, to find another movie with the same actor, or another TV show in the same series.

## Using the Roku Channel Store

- Only in connected mode, the Streaming Channels menu option takes you to the Roku Channel store, where you can add new subscription-based and free streaming channels to your TV.
- Tip: You also can search for streaming channels by using the Search option, as explained in Searching for something to watch.
- To make it easier to find what you want, the streaming channels in the Roku Channel Store are categorized by topic. Press the UP and DOWN arrows to highlight the category you want, and then press the RIGHT arrow to move the highlight into the grid of streaming channel tiles.
- When you find a streaming channel you want to add or learn more about, highlight it and press OK to display more details.
  - If the streaming channel you are adding is free, you can select Go to channel to start watching it immediately.
  - If there is a one-time or recurring fee associated with using the streaming channel, you must agree to the terms and conditions, accept the fee, and—if

you created one when you activated your TCL Roku TV, enter your Roku PIN code to authorize the charges.



- If you already have a subscription to the streaming channel—for example, you already subscribe to Netflix or you receive HBO through your cable TV provider—you must complete a different, simple authorization step to add the streaming channel.
- You need only complete the authorization or activation step one time, when you initially add the streaming channel. After that, you simply select the streaming channel tile from your Home screen to start watching. (Channel and content availability is subject to change. Charges may apply to your selection.)
- Tip: New streaming channels are added continuously to the Roku Channel Store, so be sure to check back every now and then for new options.
- Note: If you don't remember your PIN, or if you want to change whether you need to use a PIN to make purchases on your Roku account, see [Changing your Roku Channel Store PIN preference](#).

## Customizing your TV

There are several things you can do to personalize your TV.

### Add TV inputs



As you use your TV, you might find that you need to add a TV input tile that you did not add during Guided Setup. To add a TV input:

1. From the Home screen menu, navigate to Settings > TV inputs. Notice that the list of inputs is divided into two sections: Inputs being used and Inputs not used.
2. Press the UP or DOWN arrows to highlight an input in the Inputs not used section of the list.
3. Press the RIGHT arrow to move the highlight to Set up input.
4. Press OK to add the input.
5.  Press  to return to the Home screen. Notice that the input has been added to the top of the Home screen. If you want to move the input tile to a different position in the grid, see [Rearrange tiles](#)

### Add streaming channels

- You can add streaming channels by searching in the Roku Channel Store. New streaming channels are added to the bottom of the Home screen. If you want to move the channel tile to a different position in the grid, see [Rearrange tiles](#).

## Rename inputs

- Rather than trying to remember that your Blu-ray™ player is connected to HDMI 1 and your game console is connected to HDMI 3, you can rename the TV inputs to match the connected device.
- Note: Renaming an input also changes the icon associated with it.
- To rename an input, you can either:
  - Highlight the input tile in the Home screen, and then press \* to display a list of options. From the list of options, select Rename input. Then select a new name and icon. or
  - From the Home screen, navigate to Settings > TV inputs. On the TV inputs screen, select the input you want to rename, select Rename, and then choose a new name and icon from the provided list.
- Rather than using the predefined names and icons, you can set a custom name and icon. To do so, scroll up or down to highlight Set custom name & icon, and then press OK. Follow the instructions on the screen to enter a name and select an icon for the input.
-  Press  to return to the Home screen. The new name and icon are now in effect.

## Other information

### Battery Caution and Disposal Information

- For best results, use alkaline batteries.
- Install only new batteries of the same type in your product.
- Failure to insert batteries in the correct polarity, as indicated in the battery compartment, may shorten the life of the batteries or cause batteries to leak.
- Do not mix old and new batteries.
- Do not use Rechargeable (Nickel Cadmium) or (Nickel Metal Hydride) batteries.
- Do not mix Alkaline, Standard (Carbon-Zinc) or Rechargeable (Nickel Cadmium) or (Nickel Metal Hydride) batteries.
- Do not dispose of batteries in fire.
- Recycle or dispose of batteries as per state and local guidelines.

### Electronics Recycling Information

- For Consumers TCL strives to provide a high level of service to our customers and in the communities we serve, and recommends that consumers always look for a recycling or

reuse alternative to throwing away televisions and other electronics. We encourage customers to recycle end-of-life electronic devices using one of the many convenient methods available today. In many states, TCL has programs in place to enable consumers to drop-off and recycle televisions free of charge. For information on electronics recycling in all 50 states, including drop-off locations, please visit the “Electronics Recycling” area of the TCL USA website

## Care and Cleaning

- Caution: Turn off your TV before cleaning.
- Clean the TV as needed using a soft lint-free cloth. Be sure to occasionally dust the ventilation slots in the cabinet to help assure adequate ventilation.
- **IMPORTANT:** Never use strong cleaning agents, such as ammonia-based cleaners, or abrasive powder. These types of cleaners will damage the TV. The TV’s screen may be cleaned with a soft, lint-free cloth as well. Take care not to scratch or mar the screen. If necessary, you may use a cloth dampened with warm water. While cleaning, do not spray liquid directly on the screen, or allow liquid to run down the screen and inside the TV. Also, never place drinks or vases with water on top of the TV. This could increase the risk of fire, shock hazard or damage to the TV.

## Television Specifications

- Broadcasting system: US System NTSC-M, ATSC standard (8VSB), QAM
- Receiving Channels: VHF2-13, UHF14-69, CATV 14-36 (A)-(W), 37- 59 (AA)- (WW), 60-85 (AAA)-(ZZZ), 86-94 (86)- (94), 95-99 (A-5)-(A-1), 100-135(100)-(135), 01 (4A)
- Tuner type: Frequency synthesized
- Operating Temperature: 5°C to 35°C (41°F to 95°F)
- Operating Humidity: 20% to 80%, non-condensing
- Storage Temperature: -15°C to 45°C (5°F to 113°F)
- Storage Humidity: 10% to 90%, non-condensing

### Warning

This content is compiled from multiple sources and is provided for reference purposes only. It may not be complete or fully applicable to all situations. If you are unable to resolve your issue, please contact the product manufacturer or an authorized service provider for official support.