

Operating Instructions

Using the gas surface burners

Before Lighting a Gas Burner

- Make sure all burners are in place.
- Make sure all grates on the range are properly placed before using any burner.

After Lighting a Gas Burner

- Do not operate the burner for an extended period of time without cookware on the grate. The finish on the grate may chip without cookware to absorb the heat.
- Be sure the burners and grates are cool before you place your hand, a pot holder, cleaning cloths or other materials on them.

How to Light a Gas Surface Burner

Make sure all the surface burners are placed in their respective positions.

Push the control knob in and turn it to the Lite position.



You will hear a little clicking noise—the sound of the electric spark igniting the burner.

Turn the knob to adjust the flame size. If the knob stays at Lite, it will continue to click.

When one burner is turned to Lite, all the burners spark. Do not attempt to disassemble or clean around any burner while another burner is on. An electric shock may result, which could cause you to knock over hot cookware.

Sealed Gas Burners

Your gas range cooktop, depending on model, has either four or five sealed gas burners. They offer convenience, cleanability and flexibility to be used in a wide range of cooking applications.



The smallest burner in the right rear position is the simmer burner. This burner can be turned down to Lo for a very low simmer setting. It provides precise cooking performance for delicate foods such as sauces or foods that require low heat for a long cooking time.

The medium (left rear and, on some models, left front) and the large (left front and, on some models, right front) burners are the primary burners for most cooking. These generalpurpose burners can be turned down from Hi to Lo to suit a wide range of cooking needs.

The extra large burner (right front, on some models) is the maximum output burner. Like the other four burners, it can be turned down from Hi to Lo for a wide range of cooking applications; however, this burner is designed to quickly bring large amounts of liquid to a boil. It has a special Power Boil™ setting designed to be used with cookware 10 inches or larger in diameter.

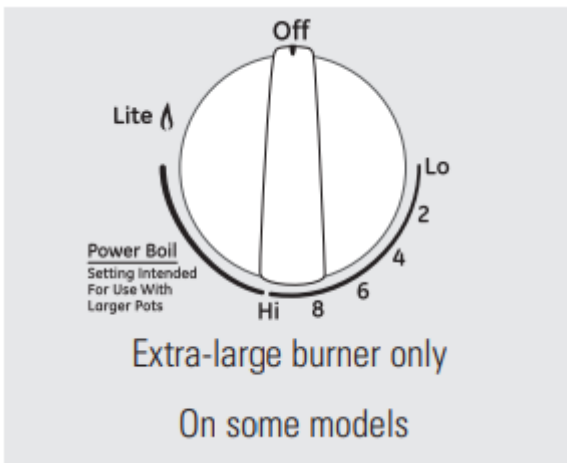

The center oval burner (on some models) is for large pots/pans or for use with the griddle.

How to Select Flame Size

For safe handling of cookware, never let the flames extend up the sides of the cookware.

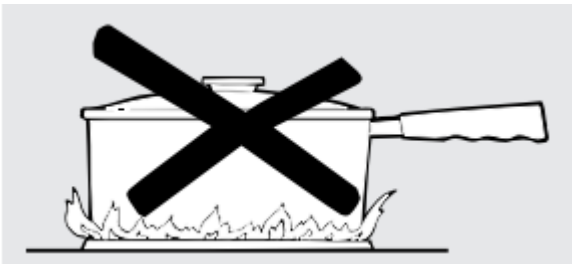

Watch the flame, not the knob, as you reduce heat. When fast heating is desired, the flame size on a gas burner should match the cookware you are using.

Flames larger than the bottom of the cookware will not result in faster heating of the cookware and could be hazardous.

Top-of-Range Cookware

Aluminum: Medium-weight cookware is recommended because it heats quickly and evenly. Most foods brown evenly in an aluminum skillet. Use saucepans with tightfitting lids when cooking with minimum amounts of water.

Cast-Iron: If heated slowly, most skillets will give satisfactory results.

Enamelware: Under some conditions, the enamel of some cookware may melt. Follow cookware manufacturer's recommendations for cooking methods.

Glass: There are two types of glass cookware—those for oven use only and those for top-of-range cooking (saucepans, coffee and teapots). Glass conducts heat very slowly.

Heatproof Glass Ceramic: Can be used for either surface or oven cooking. It conducts heat very slowly and cools very slowly. Check cookware manufacturer's directions to be sure it can be used on gas ranges.

Stainless Steel: This metal alone has poor heating properties and is usually combined with copper, aluminum or other metals for improved heat distribution. Combination metal skillets usually work satisfactorily if they are used with medium heat as the manufacturer recommends.

Stove Top Grills (on models with sealed burners)

Do not use stove top grills on your sealed gas burners. If you use the stove top grill on the sealed gas burner, it will cause incomplete combustion and can result in exposure to carbon monoxide levels above allowable current standards.



This can be hazardous to your health.

Wok This Way (on models with sealed burners) We recommend that you use a 14" or smaller flat-bottomed wok. Make sure the wok bottom sits flat on the grate. They are available at your local retail store.



Only a flat-bottomed wok should be used.

Do not use a flat-bottomed wok on a support ring. Placing the ring over the burner or grate may cause the burner to work improperly, resulting in carbon monoxide levels above allowable standards. This could be dangerous to your health.



In Case of Power Failure

In case of a power failure, you can light the gas surface burners on your range with a match. Hold a lit match to the burner, then push in and turn the control knob to the Lite position. Use extreme caution when lighting burners this way.

Surface burners in use when an electrical power failure occurs will continue to operate normally.

Using the griddle. (on some models)



Your non-stick coated griddle provides an extra-large cooking surface for meats, pancakes or other food usually prepared in a frying pan or skillet.

NOTE: Your griddle will discolor over time as it becomes seasoned with use.

How to Insert the Griddle



CAUTION: Place and remove the griddle only when all grates and griddle are cool and all surface units are turned OFF.

The griddle can only be used with the center burner. To insert the griddle, remove the center grate and replace with the griddle.

Using the Griddle

Most griddled foods require cooking on a preheated surface

NOTE: Griddle settings may need to be adjusted if the griddle is used for an extended time.

IMPORTANT NOTES:

- Avoid cooking extremely greasy foods and be careful of grease spill-over while cooking.
- Do not use oil on the griddle for extended lengths of time. Permanent staining and/or craze lines on the surface could result.
- Never place or store any items on the griddle, even when it is not in use. The griddle can become heated when using the surrounding burners.
- Do not overheat the griddle. Leaving the griddle burner on at HI for an extended amount of time without food can damage the non-stick coating.
- Avoid using metal utensils with sharp points or rough sharp edges which might damage the griddle surface.
- Do not cut foods on the griddle

Using the oven controls



Oven Control, Clock and Timer Features and Settings (on some models)

1. Bake/Temp Recall Pad

Touch this pad to select the bake function.

Bake Light

Flashes while in edit mode—you can change the oven temperature at this point. Glows when the oven is in bake mode.

2. Start/On Pad

Must be touched to start any cooking or cleaning function.

3. Display

Shows the time of day, oven temperature, whether the oven is in the bake, broil or selfcleaning mode and the times set for the timer or automatic oven operations. The display will show PRE while preheating. When the oven reaches the selected temperature, the oven control will beep and the display will show the oven temperature.

If “F– and a number or letter” flash in the display and the oven control signals, this indicates a function error code.

If your oven was set for a timed oven operation and a power outage occurred, the clock and all programmed functions must be reset.

The time of day will flash in the display when there has been a power outage. Reset the clock.

On models with an oven door latch, if the function error code appears during the self-cleaning cycle, check the oven door latch. The latch handle may have been moved, even if only slightly, from the latched position. Make sure the latch is moved to the right as far as it will go.

Touch the Clear/Off pad. Allow the oven to cool for one hour. Put the oven back into operation. If the function error code repeats, disconnect the power to the range and call for service.

4. Kitchen Timer On/Off Pad

Touch this pad to select the timer feature. Then press the + and – pads to adjust the timer.

Kitchen Timer Light

Flashes while in edit mode—you can change the set time at this point. Glows when the timer has been activated. Flashes again when the time has run out until the control is reset.

5. Clock Pad

To set the clock, press this pad twice and then press the + and – pads. The time of day will flash in the display when the oven is first turned on.

6. Start Time Pad

Use along with the Cooking Time or Self Clean pads to set the oven to start and stop automatically at a time you set.

Start Time Light

Flashes while in edit mode—you can change the start time at this point. Glows when the function has been activated.

7. Cooking Time Pad

Touch this pad and then touch the + or – pads to set the amount of time you want your food to cook. The oven will shut off when the cooking time has run out.

Cooking Time Light

Flashes while in edit mode—you can change the set time at this point. Glows when the function has been activated. Flashes again when the time has run out until the control is reset.

8. Automatic Oven Light (on some models)

This lights anytime the oven has been programmed using the Cooking Time or Start Time functions.

9. Oven Light On/Off Pad

Touch this pad to turn the oven light on or off.

10. – Pad

Short taps to this pad will decrease the time or temperature by small amounts. Touch and hold the pad to decrease the time or temperature by larger amounts.

11. + Pad

Short taps to this pad will increase the time or temperature by small amounts. Touch and hold the pad to increase the time or temperature by larger amounts.

12. Self Clean Pad

Touch this pad to select the self-cleaning function. See the Using the self-cleaning oven section.

Clean Light

Flashes while in edit mode—you can change the length of time for the self-clean cycle at this point. Glows when the oven is in the self-clean cycle. After the self-clean cycle, the light will turn off. When the light is off, slide the latch handle to the left as far as it will go and open the door. If your range does not have a latch, the door will unlock automatically.

13. Clear/Off Pad

Touch this pad to cancel ALL oven operations except the clock and timer.

14. Broil Hi/Lo Pad

Touch this pad to select the broil function.

Broil Light

Flashes while in edit mode—you can switch from Hi to Lo Broil at this point. Glows when the oven is in broil mode.

Indicator Lights (on some pads)

Edit mode lasts several seconds after the last pad press. Start Time and Cooking Time will be the only pads lit if either of these options is selected. (Example: Start Time is selected with Bake—the Start Time pad will remain lit until the clock reaches the programmed time, at which point it will turn off and the Bake/Temp Recall pad light will light up).

Using the oven

To avoid possible burns, place the racks in the desired position before you turn the oven on.

Before you begin...

The oven has 5 rack positions.

It also has a special low rack position (R) for extra large items, such as a large turkey.



The racks have stop-locks, so that when placed correctly on the rack supports (A through E), they will stop before coming completely out, and will not tilt.

When placing and removing cookware, pull the rack out to the bump on the rack support.

To remove a rack, pull it toward you, tilt the front end up and pull it out.

To replace, place the end of the rack (stoplocks) on the support, tilt up the front and push the rack in.

NOTE: The rack is not designed to slide out at the special low rack (R) position.

Oven Vent

Plastic items on the cooktop may melt if left too close to the vent.

Vent appearance and location vary.



Your oven is vented through ducts at the rear of the range. Do not block these ducts when cooking in the oven—it is important that the flow of hot air from the oven and fresh air to the oven burner be uninterrupted. Avoid touching the vent openings or nearby surfaces during oven or broiler operation— they may become hot.

- Handles of pots and pans on the cooktop may become hot if left too close to the vent.
- Do not leave plastic or flammable items on the cooktop—they may melt or ignite if left too close to the vent.
- Do not leave closed containers on the cooktop. The pressure in closed containers may increase, which may cause them to burst.
- Metal items will become very hot if they are left on the cooktop, and could cause burns.

Power Outage

CAUTION: Do not make any attempt to operate the electric ignition oven during an electrical power failure.

The oven or broiler cannot be lit during a power failure. Gas will not flow unless the glow bar is hot.

If the oven is in use when a power failure occurs, the oven burner shuts off and cannot be re-lit until power is restored. This is because the flow of gas is automatically stopped and will not resume when power is restored until the glow bar has reached operating temperature.

Oven Light

Touch the Oven Light pad on the upper control panel to turn the light on or off.

How to Set the Oven for Baking or Roasting

The oven has a special low rack (R) position just above the oven bottom. Use it when extra cooking space is needed, for example, when cooking a large turkey. The rack is not designed to slide out at this position.



Your oven is not designed for open-door cooking.

1. Touch the Bake pad.
2. Touch the + or – pads until the desired temperature is displayed.
3. Touch the Start/On pad.

The oven will start automatically. The display will show PRE while preheating. When the oven reaches the selected temperature, the oven control will beep several times and the display will show the oven temperature.

To change the oven temperature during Bake cycle, touch the Bake pad and then the + or – pads to get the new temperature.

4. Check food for doneness at minimum time on recipe. Cook longer if necessary.
5. Touch the Clear/Off pad when baking is finished and then remove the food from the oven.

Preheating and Pan Placement

Preheat the oven if the recipe calls for it. To preheat, set the oven at the correct temperature. Preheating is necessary for good results when baking cakes, cookies, pastry and breads.

For ovens without a preheat indicator light or tone, preheat 10 minutes.

Baking results will be better if baking pans are centered in the oven as much as possible. Pans should not touch each other or the walls of the oven. If you need to use two racks, stagger the pans so one is not directly above the other, and leave approximately 1 1/2" between pans, from the front, back and sides of the wall.

Aluminum Foil

Do not use aluminum foil on the bottom of the oven.

Never entirely cover a rack with aluminum foil. This will disturb the heat circulation and result in poor baking.

A smaller sheet of foil may be used to catch a spillover by placing it on a lower rack several inches below the food.

Oven Moisture

As your oven heats up, the temperature change of the air in the oven may cause water droplets to form on the door glass. These droplets are harmless and will evaporate as the oven continues to heat up.

How to Set the Oven for Broiling

Close the door. Always broil with the door closed.



NOTE: On models with an Oven Temp knob, turn it to Broil.

1. Place the meat or fish on a broiler grid in a broiler pan.
2. Follow suggested rack positions in the Broiling Guide.
3. The oven door must be closed during broiling.
4. Touch the Broil Hi/Lo pad once for Hi Broil.

To change to Lo Broil, touch the Broil Hi/Lo pad again.

5. Touch the Start/On pad.
6. When broiling is finished, touch the Clear/Off pad.

Serve the food immediately, and leave the pan outside the oven to cool during the meal for easiest cleaning.

Use Lo Broil to cook foods such as poultry or thick cuts of meat thoroughly without over-browning them.

Using the clock and timer

To Set the Clock

Make sure the clock is set to the correct time of day.



The clock must be set to the correct time of day for the automatic oven timing functions to work properly. The time of day cannot be changed during a delayed cooking or a delayed self-cleaning cycle.

1. Touch the Clock pad twice.
2. Touch the + or – pads.

If the + or – pads are not touched within one minute after you touch the Clock pad, the display reverts to the original setting. If this happens, touch the Clock pad twice and reenter the time of day.

3. Touch the Start/On pad until the time of day shows in the display. This enters the time and starts the clock.

To check the time of day when the display is showing other information, simply touch the Clock pad. The time of day shows until another pad is touched.

To Turn Off the Clock Display

If you have several clocks in your kitchen, you may wish to turn off the time of day clock display on your range.

1. Touch the Clock pad once to turn off the time of day display. Although you will not be able to see it, the clock maintains the correct time of day.

2. Touch the Clock pad twice to recall the clock display.

To Set the Timer

The timer is a minute timer only. The Clear/Off pad does not affect the timer.



The timer does not control oven operations. The maximum setting on the timer is 9 hours and 59 minutes.

1. Touch the Kitchen Timer On/Off pad.

2. Touch the + or – pads until the amount of time you want shows in the display. The maximum time that can be entered in minutes is 59. Times more than 59 minutes should be changed to hours and minutes.

If you make a mistake, touch the Kitchen Timer On/Off pad and begin again.

3. Touch the Start/On pad. The time will start counting down, although the display does not change until one minute has passed.

4. When the timer reaches :00, the control will beep 3 times followed by one beep every 6 seconds until the Kitchen Timer On/Off pad is touched.

To Reset the Timer

If the display is still showing the time remaining, you may change it by touching the Kitchen Timer On/Off pad, then touch the + or – pads until the time you want appears in the display.

If the remaining time is not in the display (clock, start time or cooking time are in the display), recall the remaining time by touching the Kitchen Timer On/Off pad and then touching the + or – pads to enter the new time you want.

To Cancel the Timer

Touch the Kitchen Timer On/Off pad twice.

End of Cycle Tones (on some models)



Clear the tones by pressing the pad of the function you are using.

Power Outage

If a flashing time is in the display, you have experienced a power failure. Reset the clock.

To reset the clock, touch the Clock pad. Enter the correct time of day by touching the + or – pads. Touch the Start/On pad.

Using the timed baking and roasting features

If your model has a door latch, do not lock the oven door with the latch during timed cooking. The latch is used for self-cleaning only.

NOTE: Foods that spoil easily—such as milk, eggs, fish, stuffings, poultry and pork—should not be allowed to sit for more than 1 hour before or after cooking. Room temperature promotes the growth of harmful bacteria. Be sure that the oven light is off because heat from the bulb will speed harmful bacteria growth.

How to Set an Immediate Start and Automatic Stop

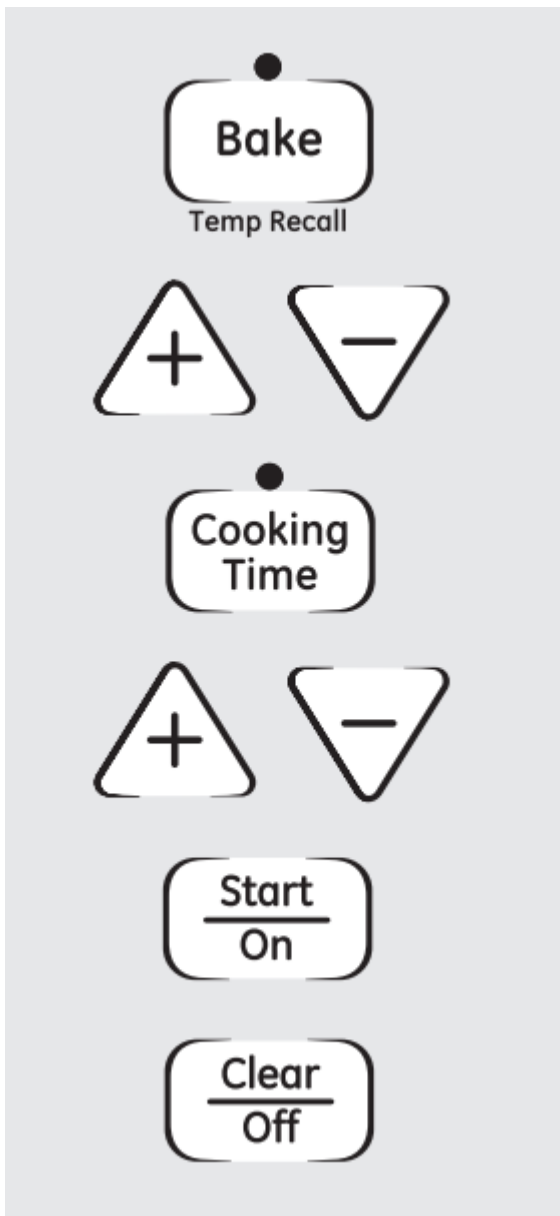

The oven will turn on immediately and cook for a selected length of time. At the end of the cooking time, the oven will turn off automatically.

1. Touch the Bake pad.
2. Touch the + or – pads to set the oven temperature.
3. Touch the Cooking Time pad.

NOTE: If your recipe requires preheating, you may need to add additional time to the length of the cooking time.

4. Touch the + or – pads to set the baking time.

The cooking time that you entered will be displayed. (If you select Cooking Time first and then adjust the Bake Temperature, the oven temperature will be displayed instead).

5. Touch the Start/On pad.

The display shows either the oven temperature that you set or the cooking time countdown. (The display starts with PRE if showing the oven temperature.)

The oven will continue to cook for the programmed amount of time, then turn off automatically.

6. Touch the Clear/Off pad to clear the display if necessary.

Remove the food from the oven. Remember, even though the oven shuts off automatically, foods continue cooking after controls are off

How to Set a Delayed Start and Automatic Stop



The oven will turn on at the time of day you set, cook for a specific length of time and then turn off automatically.

Make sure the clock shows the correct time of day.

1. Touch the Bake pad.

2. Touch the + or – pads to set the oven temperature.
3. Touch the Cooking Time pad.
4. Touch the + or – pads to set the desired length of cooking time.
5. Touch the Start Time pad.
6. Touch the + or – pads to set the time of day you want the oven to turn on and start cooking.
7. Touch the Start/On pad.

NOTE: An attention tone will sound if you are using timed baking and do not touch the Start/On pad.

NOTE: If you would like to check the times you have set, touch the Start Time pad to check the start time you have set or touch the Cooking Time pad to check the length of cooking time you have set.

When the oven turns on at the time of day you have set, the display will show PRE until it reaches the selected temperature, then it will display the oven temperature.

At the end of cooking time, the oven will turn off and the end of cycle tone will sound.

8. Touch the Clear/Off pad to clear the display if necessary.

Remove the food from the oven. Remember, even though the oven shuts off automatically, foods continue cooking after controls are off.

Special features of your oven control

Your new touch pad control has additional features that you may choose to use. The following are the features and how you may activate them.

The special feature modes can only be activated while the display is showing the time of day. They remain in the control's memory until the steps are repeated.

When the display shows your choice, touch the Start/On pad. The special features will remain in memory after a power failure.

NOTE: The Sabbath feature and the Thermostat Adjustment feature are also Special Features, but they are addressed separately in the following sections.

12-Hour Shut-Off



With this feature, should you forget and leave the oven on, the control will automatically turn off the oven after 12 hours during baking functions or after 3 hours during a broil function.

If you wish to turn OFF this feature, follow the steps below.



1. Touch the Bake and Broil Hi/Lo pads at the same time for 3 seconds until the display shows SF.
2. Touch the Clock pad. The display will show On (12-hour shut-off). Touch the Clock pad repeatedly until the display shows Off (no shut-off).
3. Touch the Start/On pad to activate the no shut-off and leave the control set in this special features mode.

Using the Sabbath Feature

The Sabbath feature can be used for baking/roasting only. It cannot be used for broiling, self-cleaning or Delay Start cooking.

NOTE: The oven light comes on automatically (on some models) when the door is opened and goes off when the door is closed. The bulb may be removed. See the Oven Light Replacement section. On models with a light switch on the control panel, the oven light may be turned on and left on.

How to Set for Regular Baking/Roasting

When the display shows  the oven is set in Sabbath. When the display shows  the oven is baking/roasting.





NOTE: To understand how the oven control works, practice using regular baking (non-Sabbath) before entering Sabbath mode.

Make sure the clock shows the correct time of day and the oven is off.

1. Touch and hold both the Bake and Broil Hi/Lo pads, at the same time, until the display shows SF.
2. Tap the Clock pad until SAb appears in the display.
3. Touch the Start/On pad and  will appear in the display.
4. Touch the Bake pad. No signal will be given.
5. The preset starting temperature will automatically be set to 350°. Tap the + or – pads to increase or decrease the temperature in 25° increments. The temperature can be set between 170° and 550°. No signal or temperature will be given.



6. Touch the Start/On pad.

7. After a random delay period of approximately 30 seconds to 1 minute,  will appear in the display indicating that the oven is baking/roasting. If   doesn't appear in the display, start again at Step 4.

To adjust the oven temperature, touch the Bake pad and tap the + or – pads to increase or decrease the temperature in 25° increments. Touch the Start/On pad.

NOTE: The Clear/Off and Cooking Time pads are active during the Sabbath feature.



How to Set for Timed Baking/Roasting—Immediate Start and Automatic Stop

When the display shows  the oven is set in Sabbath. When the display shows   the oven is baking/roasting





NOTE: To understand how the oven control works, practice using regular (non-Sabbath) Immediate Start and Automatic Stop before entering the Sabbath mode.

Make sure the clock shows the correct time of day and the oven is off.

1. Touch and hold both the Bake and Broil Hi/Lo pads, at the same time, until the display shows SF.
2. Tap the Clock pad until SAb appears in the display.
3. Touch the Start/On pad and  will appear in the display.
4. Touch the Cooking Time pad.
5. Touch the + or – pads to set the desired length of cooking time between 1 minute and 9 hours and 59 minutes. The cooking time that you entered will be displayed.
6. Touch the Start/On pad.
7. Touch the Bake pad. No signal will be given.
8. The preset starting temperature will automatically be set to 350°. Tap the + or – pads to increase or decrease the temperature in 25° increments. The temperature can be set between 170° and 550°. No signal or temperature will be given.
9. Touch the Start/On pad.
10. After a random delay period of approximately 30 seconds to 1 minute,  will appear in the display indicating that the oven is baking/roasting. If  doesn't appear in the display, start again at Step 7.

To adjust the oven temperature, touch the Bake pad and tap the + or – pads to increase or decrease the temperature in 25° increments. Touch the Start/On pad.

When cooking is finished, the display will change from  to , indicating that the oven has turned OFF but is still set in Sabbath. Remove the cooked food.

How to Exit the Sabbath Feature



1. Touch the Clear/Off pad.
2. If the oven is cooking, wait for a random delay period of approximately 30 seconds to 1 minute, until only  is in the display.
3. Touch and hold both the Bake and Broil Hi/Lo pads, at the same time, until the display shows SF.
4. Tap the Clock pad until On or Off appears in the display. On indicates that the oven will automatically turn off after 12 hours. Off indicates that the oven will not automatically turn off. See the Special Features section for an explanation of the 12 Hour Shut-Off feature.
5. Touch the Start/On pad.

NOTE: If a power outage occurred while the oven was in Sabbath, the oven will automatically turn off and stay off even when the power returns. The oven control must be reset.

Adjust the oven thermostat—Do it yourself!

You may find that your new oven cooks differently than the one it replaced. Use your new oven for a few weeks to become more familiar with it. If you still think your new oven is too hot or too cold, you can adjust the thermostat yourself.

Do not use thermometers, such as those found in grocery stores, to check the temperature setting of your oven. These thermometers may vary 20–40 degrees.

NOTE: This adjustment will not affect the broiling or the self-cleaning temperatures. The adjustment will be retained in memory after a power failure.

To Adjust the Thermostat



1. Touch the Bake and Broil Hi/Lo pads at the same time for 2 seconds until the display shows SF.
2. Touch the Bake pad. A two digit number shows in the display.
3. The oven temperature can be adjusted up to (+) 35°F hotter or (-) 35°F cooler. Touch the + pad to increase the temperature in 1 degree increments.

Touch the – pad to decrease the temperature in 1 degree increments.

4. When you have made the adjustment, touch the Start/On pad to go back to the time of day display. Use your oven as you would normally.

NOTE: This adjustment will not affect the broiling or self-cleaning temperatures. It will be retained in memory after a power failure.

The type of margarine will affect baking performance!

Most recipes for baking have been developed using high fat products such as butter or margarine (80% fat). If you decrease the fat, the recipe may not give the same results as with a higher fat product.

Recipe failure can result if cakes, pies, pastries, cookies or candies are made with low fat spreads. The lower the fat content of a spread product, the more noticeable these differences become.

Federal standards require products labeled “margarine” to contain at least 80% fat by weight. Low fat spreads, on the other hand, contain less fat and more water. The high moisture content of these spreads affects the texture and flavor of baked goods. For best results with your old favorite recipes, use margarine, butter or stick spreads containing at least 70% vegetable oil.

Using the self-cleaning oven

Before a Clean Cycle

Wipe up heavy soil on the oven bottom.



For the first self-clean cycle, we recommend venting your kitchen with an open window or using a ventilation fan or hood.

Remove the racks, any broiler pan, broiler grid, all cookware and any aluminum foil from the oven.

The oven racks can be self-cleaned, but they will darken, lose their luster and become hard to slide.

Do not use commercial oven cleaners or oven protectors in or near the self-cleaning oven. A combination of any of these products plus the high clean cycle temperatures may damage the porcelain finish of the oven.

Soil on the front frame of the range and outside the gasket on the door will need to be cleaned by hand. Clean these areas with hot water, soap-filled scouring pads or cleansers such as Soft Scrub®. Rinse well with clean water and dry.

Do not clean the gasket. The fiberglass material of the oven door gasket cannot withstand abrasion. It is essential for the gasket to remain intact. If you notice it becoming worn or frayed, replace it.

Wipe up any heavy spillovers on the oven bottom.

Make sure the oven light bulb cover is in place and the oven light is off.

CAUTION: The grates and drip pans (if so equipped) should never be cleaned in the self-cleaning oven.

Do not use commercial oven cleaners or oven protectors in or near the self-cleaning oven. A combination of any of these products plus the high clean cycle temperatures may damage the porcelain finish of the oven.

IMPORTANT: The health of some birds is extremely sensitive to the fumes given off during the self-cleaning cycle of any range. Move birds to another well-ventilated room.

How to Set the Oven for Cleaning

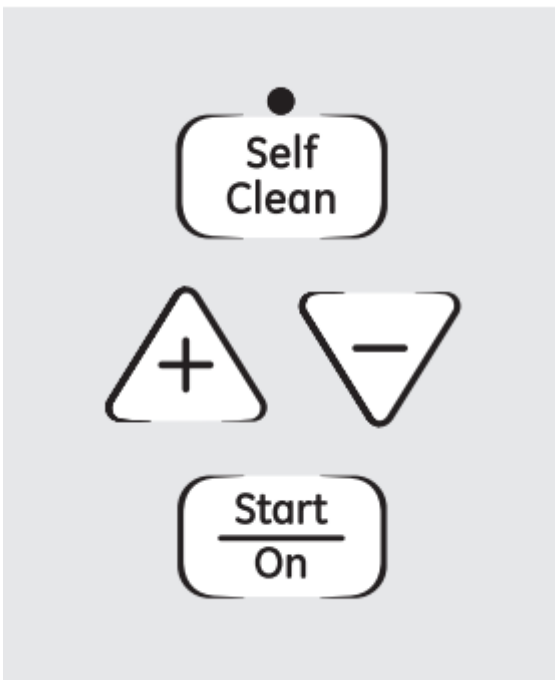

Follow the directions in the Before a Clean Cycle section.

1. If your model has a latch, latch the door.

NOTE: Never force the latch. If the oven is too hot, you will not be able to slide the latch. Allow the oven to cool.

2. Touch the Self Clean pad.

3. Touch the + or – pads until the desired Clean Time is displayed.

The Clean Time is normally 4 hours and 20 minutes. You can change the Clean Time to any time between 3 and 5 hours, depending on the amount of soil in your oven.

4. Touch the Start/On pad.

The oven control will signal if you set the clean cycle and forget to close the oven door or forget to latch the door on models with a latch.

The self-clean cycle will automatically begin after Clean is displayed and the time countdown appears in the display.

On models without a door latch, the door locks automatically. It will not be possible to open the oven door until the temperature drops below the lock temperature and the Self Clean light goes off.

While the oven is self-cleaning, you can touch the Clock pad to display the time of day. To return to the clean countdown, touch the Self Clean pad.

The oven shuts off automatically when the clean cycle is complete, and 0:00 will flash in the display.

5. When the Self Clean light is off, slide the latch handle to the left as far as it will go and open the door. If your range does not have a latch, the door will unlock automatically.

How to Delay the Start of Cleaning

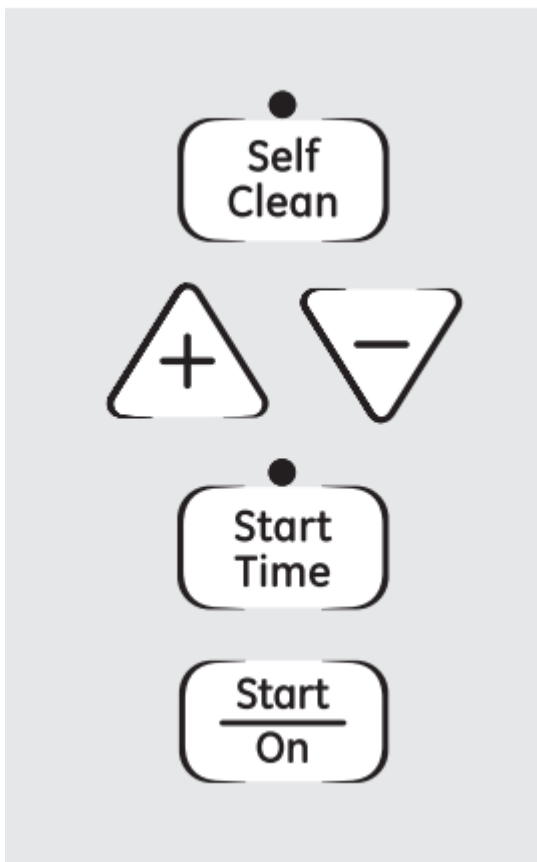

You can set the oven control to delay-start the oven, clean for a specific length of time and then turn off automatically.

Make sure the clock shows the correct time of day.

Follow the directions in the Before a Clean Cycle section.

1. If your model has a latch, latch the door.

NOTE: Never force the latch. If the oven is too hot, you will not be able to slide the latch. Allow the oven to cool.

2. Touch the Self Clean pad.

3. Touch the + or – pads to set the Clean Time.

The Clean Time is preset for 4 hours and 20 minutes. You can change the Clean Time to any time between 3 and 5 hours, depending on the amount of soil in your oven. If a different Clean Time is desired, touch the + or – pads until the desired Clean Time is displayed.

4. Touch the Start Time pad.

Change the Start Time by touching the + or – pads. The start time will appear in the display.

5. Touch the Start/On pad.

The oven control will signal if you set the clean cycle and forget to close the oven door or forget to latch the door on models with a latch.

On models without a door latch, the door locks automatically. The display will show the start time. It will not be possible to open the oven door until the temperature drops below the lock temperature and the Self Clean light goes off.

The self-clean cycle will automatically begin at the time set.

While the oven is self-cleaning, you can touch the Clock pad to display the time of day. To return to the clean countdown, touch the Self Clean pad.

The oven shuts off automatically when the clean cycle is complete, and 0:00 will flash in the display.

6. When the Self Clean light is off, slide the latch handle to the left as far as it will go and open the door. If your range does not have a latch, the door will unlock automatically.

To Stop a Clean Cycle

Touch the Clear/Off pad.

When the Self Clean light goes off indicating the oven has cooled below the locking temperature, unlatch the door (on models with a latch) and open the door.

After a Clean Cycle

You cannot set the oven for cooking until the oven is cool enough for the door to be unlatched.

You may notice some white ash in the oven. Wipe it up with a damp cloth after the oven cools.

If white spots remain, remove them with a soap-filled scouring pad and rinse thoroughly with a vinegar and water mixture.

These deposits are usually a salt residue that cannot be removed by the clean cycle.

If the oven is not clean after one clean cycle, repeat the cycle.

- You cannot set the oven for cooking until the oven is cool enough for the door to unlock.
- While the oven is self-cleaning, you can touch the Clock pad to display the time of day. To return to the clean countdown, touch the Cooking Time pad.
- If the racks become hard to slide, apply a small amount of vegetable oil or cooking oil to a paper towel and wipe the edges of the oven racks with the paper towel.

Care and cleaning of the range

Be sure electrical power is off and all surfaces are cool before cleaning any part of the range.

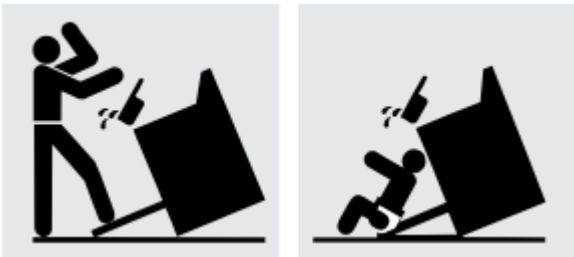

WARNING: If your range is removed for cleaning, servicing or any reason, be sure the anti-tip device is re-engaged properly when the range is replaced. Failure to take this precaution could result in tipping of the range and cause injury.

Griddle (on some models)



NOTES:

- The griddle is to be used over the center burner only.
- Do not clean the griddle in a dishwasher.
- Wash with hot, soapy water after each use while using a sponge or dishcloth.
- If oil or food residue is left on the griddle, further cooking will harden the residue and cause sticking over time. In this case, use a non-abrasive cleanser such as Bon Ami® or one of the soft scrub cleansers. Apply with a sponge, Scrunge® or other cleaning pad labeled safe for non-stick pans
- Use only plastic, nylon or wooden utensils or SilverStone® kitchen tools to prevent marring of the coating.
- Never use knives or cut food on the griddle. Wash with hot, soapy water after each use. Store carefully to prevent scratching.

Griddle Precautions:

- If something has spilled under the griddle, it should be cleaned up as soon as possible to prevent “baked on” food soil.
- Do not allow grease to accumulate under the griddle as it can be a fire hazard. Clean under the griddle as soon as it is cool. Clean with hot soapy water.
- Do not place your griddle in the microwave.
- Always turn off all surface burners before removing the griddle. Use caution when handling a hot griddle.

Sealed Burner Assemblies



Turn all controls Off before removing the burner parts.

The round side burner caps and burner heads can be lifted off, making them easy to clean. The electrodes are not removable.

The oval center burner head and cap assembly (on some models) can be lifted off, making it easy to clean. The burner electrode is not removable.



CAUTION: Do not operate the cooktop without all burner parts and grates in place.



The electrode of the spark igniter is exposed when the burner head is removed. When one burner is turned to Lite, all the burners spark. Do not attempt to disassemble or clean around any burner while another burner is on. An electric shock may result, which could cause you to knock over hot cookware.

Burner Caps and Heads

Before removing the burner caps and heads, remember their size and location. Replace them in the same location after cleaning.



Burner cap is properly seated.



Burner cap is NOT properly seated.

NOTE: Do not use steel wool or scouring powders to clean the burner parts.

Burner caps

Lift off when cool. Wash burner caps in hot, soapy water and rinse with clean water. You may scour with a plastic scouring pad to remove burned-on food particles.

Burner Heads and Oval (Center) Burner Head/Cap Assembly (on some models)

The burner heads and the oval burner head/cap assembly are removable. Simply lift them off the range for cleaning.

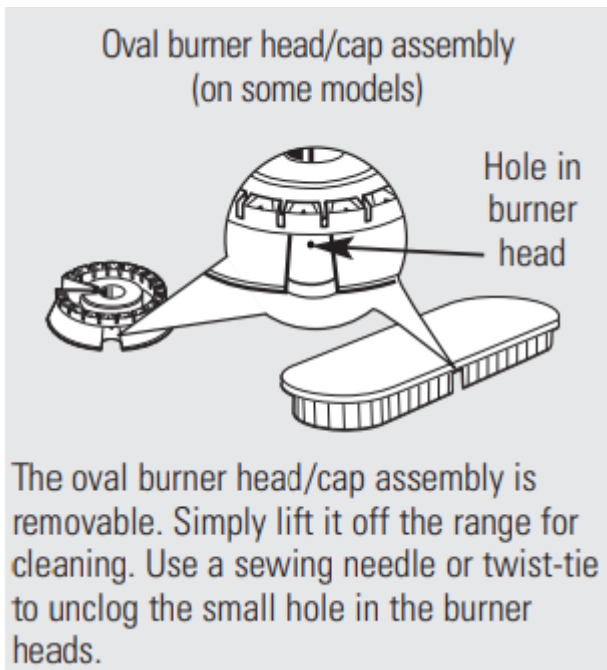
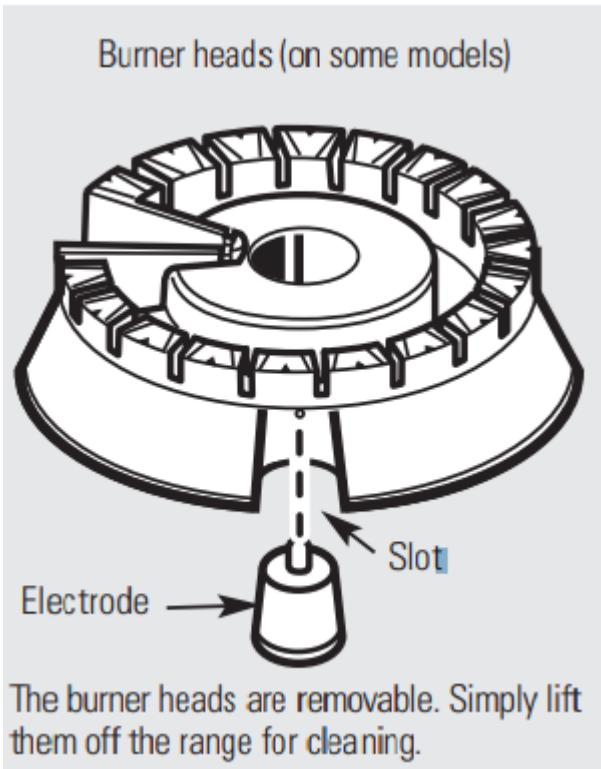

For proper ignition, make sure the small hole in the section that fits over the electrode is kept open. A sewing needle or wire twist-tie works well to unclog it.

The slits in the burner heads must be kept clean at all times for an even, unhampered flame.

Clogged or dirty burner ports or electrodes will not allow the burner to operate properly.

Any spill on or around an electrode must be carefully cleaned. Take care to not hit an electrode with anything hard or it could be damaged.

Clean the burner heads routinely, especially after bad spillovers, which could clog the openings. Lift off when cool.

To remove burned-on food, soak the burner heads in a solution of mild liquid detergent and hot water for 20–30 minutes. For more stubborn stains, use a toothbrush.

After cleaning

Before putting the burner caps, heads (on some models) and oval head/cap assembly back, shake out excess water and then dry them thoroughly by setting in a warm oven for 30 minutes.

Replacement

Replace burner heads over the electrodes on the cooktop, and then replace the burner caps onto the burner heads, in the correct locations according to their size.

On models so equipped:



On models so equipped:



Make sure the slot in the burner head is positioned over the electrode.



Make sure that the heads and caps are replaced in the correct locations.

Burner Grates

The grates may be cleaned in a dishwasher.

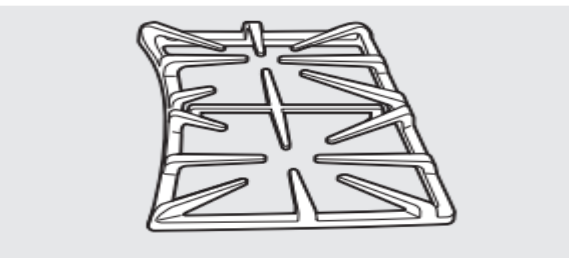

Your range has three professional-style double grates. These grates are position-specific. For maximum stability, these grates should only be used in their proper position; they cannot be

interchanged left to right or front to back. For convenience, the undersides of the left and right grates are marked “LEFT FRONT” and “RIGHT FRONT.” Make sure the front portion of both grates is in front. The middle grate has a bow in front. Make sure the bowed portion is toward the front of the range.

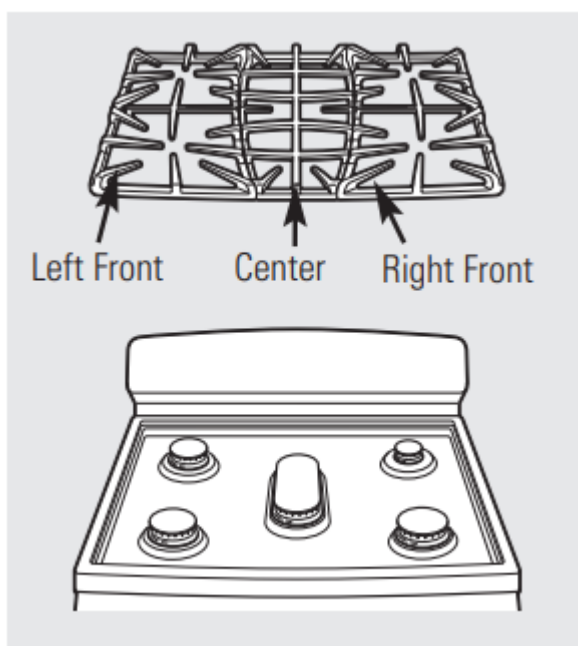

NOTE: Some models only have side grates.

Cleaning

Lift out when cool. Grates should be washed regularly and, of course, after spillovers. Wash them in hot, soapy water and rinse with clean water. When replacing the grates, be sure they are positioned securely over the burners. Replace the grates so that continuous arcs are formed with the center ribs of all three grates.

NOTE: Some models only have side grates.

Do not operate a burner for an extended period of time without cookware on the grate. The finish on the grate may chip without cookware to absorb the heat.

To get rid of burned-on food, place the grates in a covered container. Add 1/4 cup ammonia and let them soak several hours or overnight. Wash, rinse well and dry.

Although they are durable, the grates will gradually lose their shine, regardless of the best care you can give them. This is due to their continual exposure to high temperatures. You will notice this sooner with lighter color grates.

NOTE: Do not clean the grates in a selfcleaning oven.

Cooktop Surface

To avoid damaging the porcelain enamel surface of the cooktop and to prevent it from becoming dull, clean up spills right away. Foods with a lot of acid (tomatoes, sauerkraut, fruit juices, etc.) or foods with high sugar content could cause a dull spot if allowed to set.



When the surface has cooled, wash and rinse. For other spills such as fat splatterings, etc., wash with soap and water once the surface has cooled. Then rinse and polish with a dry cloth.

NOTE: Do not store flammable materials in an oven, drawer or near the cooktop. Do not store or use combustible materials, gasoline or other flammable vapors and liquids in the vicinity of this or any other appliance.

NOTE: Do not lift the cooktop. Lifting the cooktop can lead to damage and improper operation of the range.

Stainless Steel Surfaces (on some models)

Do not use a steel wool pad; it will scratch the surface.

To clean the stainless steel surface, use warm sudsy water or a stainless steel cleaner or polish. Always wipe the surface in the direction of the grain. Follow the cleaner instructions for cleaning the stainless steel surface.

Lift-Off Oven Door

Lift the door straight up and off the hinges.



The gasket is designed with a gap at the bottom to allow for proper air circulation.

Do not rub or clean the door gasket— it has an extremely low resistance to abrasion.

If you notice the gasket becoming worn, frayed or damaged in any way or if it has become displaced on the door, you should have it replaced.



The oven door is removable, but it is heavy. You may need help removing and replacing the door.

To remove the door, open it a few inches to the special stop position that will hold the door open. Grasp firmly on each side and lift the door straight up and off the hinges.

NOTE: Be careful not to place hands between the hinge and the oven door frame as the hinge could snap back and pinch fingers.

To replace the door, make sure the hinges are in the special stop position. Position the slots in the bottom of the door squarely over the hinges. Then lower the door slowly and evenly over both hinges at the same time. If the hinges snap back against the oven frame, pull them back out.

To clean the inside of the door:

- Do not allow excess water to run into any holes or slots in the door.

- Because the area inside the gasket is cleaned during the self clean cycle, you do not need to clean this by hand. Any soap left on the liner causes additional stains when the oven is heated.
- The area outside the gasket can be cleaned with a soap-filled scouring pad.

To clean the outside of the door:

- Use soap and water to thoroughly clean the top, sides and front of the oven door. Rinse well. You may also use a glass cleaner to clean the glass on the outside of the door.
- Spillage of marinades, fruit juices, tomato sauces and basting materials containing acids may cause discoloration and should be wiped up immediately. When the surface is cool, clean and rinse.
- Do not use oven cleaners, cleansing powders or harsh abrasives on the outside of the door

Oven Bottom

The oven bottom has a porcelain enamel finish. To make cleaning easier, protect the oven bottom from excessive spillovers by placing a cookie sheet on the rack below the rack you are cooking on. This is particularly important when baking a fruit pie or other foods with a high acid content. Hot fruit fillings or other foods that are highly acidic (such as tomatoes, sauerkraut, and sauces with vinegar or lemon juice) may cause pitting and damage to the porcelain enamel surface and should be wiped up immediately.

We don't recommend using aluminum foil on the oven bottom. It can affect air flow if the holes are blocked and it can concentrate heat at the bottom of the oven, resulting in poor baking performance.

To clean up spillovers, use soap and water, an abrasive cleaner or soap-filled scouring pad. Rinse well to remove any soap before self-cleaning.

Removable Kick Panel (on some models)

The kick panel may be removed for cleaning under the range.

To remove:

Lift up the bottom of the panel slightly to disengage the panel from the tabs at the base of the range. Pull the bottom of the panel forward until the spring clips are released at the top of the panel.



To replace:

Insert the two slots at the bottom of the panel onto the two tabs at the base of the range, and push the top of the panel forward to engage the spring clips.



Removable Storage Drawer (on some models)

The storage drawer is a good place to store cookware and bakeware. Do not store plastics and flammable material in the drawer.



The storage drawer may be removed for cleaning under the range. Clean the storage drawer with a damp cloth or sponge. Never use harsh abrasives or scouring pads.

To remove storage drawer:

1. Pull drawer straight out until it stops.
2. Tilt the front of the drawer up and free of the range.

To replace storage drawer:

1. Set the stops on the back of the drawer over the stops in the range.
2. Slide drawer evenly and straight back, so that the rails in the range are engaged.

Oven Air Vents



Never block the vents (air openings) of the range. They provide the air inlet and outlet that are necessary for the range to operate properly with correct combustion.

Air openings are located at the rear of the cooktop, at the top and bottom of the oven door and at the bottom of the range, under the storage drawer or kick panel (depending on the model).

Lower Control Panel (Front Manifold Panel) and Knobs

Pull the knob straight off the stem.



It's a good idea to wipe the control panel after each use of the oven. Use a damp cloth to clean or rinse. For cleaning, use mild soap and water or a 50/50 solution of vinegar and water. For rinsing, use clean water. Polish dry with a soft cloth.

Do not use abrasive cleansers, strong liquid cleaners, plastic scouring pads or oven cleaners on the control panel—they will damage the finish.

Do not bend knobs by pulling them up or down or by hanging a towel or other such loads. This can damage the gas valve shaft.

The control knobs may be removed for easier cleaning.

Make sure the knobs are in the Off positions and pull them straight off the stems for cleaning.

The knobs can be cleaned in a dishwasher or they may also be washed with soap and water. Make sure the insides of the knobs are dry before replacing.

Replace the knobs in the Off position to ensure proper placement.

Metal parts can be cleaned with soap and water. Do not use steel wool, abrasives, ammonia, acids or commercial oven cleaners. Dry with a soft cloth.

Oven Racks



Clean the racks with an abrasive cleanser or scouring pad. After cleaning, rinse the racks with clean water and dry with a clean cloth.

If the racks ever become hard to slide, wipe the rack edges or oven rack supports with vegetable oil.

NOTE: Take the racks out of the oven before you begin the self-clean cycle or they may discolor.

Oven Light Replacement

Wire cover holder

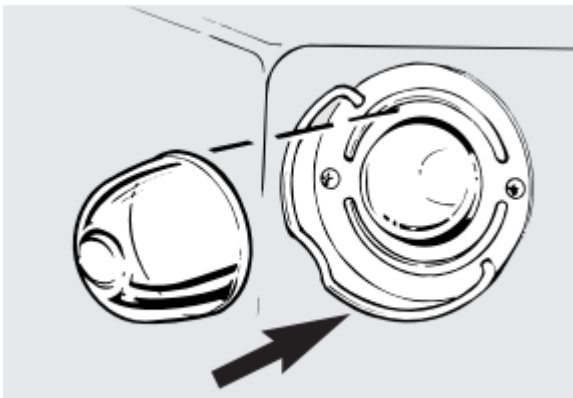

CAUTION: Before replacing your oven light bulb, disconnect the electrical power to the range at the main fuse or circuit breaker panel. Be sure to let the light cover and bulb cool completely.

The oven light bulb is covered with a removable glass cover that is held in place with a bail-shaped wire. Remove the oven door, if desired, to reach cover easily.

To remove:

1. Hold a hand under the cover so it doesn't fall when released. With fingers of the same hand, firmly push back the wire cover holder. Lift off the cover.

Do not remove any screws to remove the cover.

2. Do not touch hot bulb with a wet cloth. Replace bulb with a 40-watt household appliance bulb.

To replace cover:

1. Place it into the groove of the light receptacle. Pull the wire forward to the center of the cover until it snaps into place. When in place, the wire holds the cover firmly. Be certain the wire is in the depression in the center of the cover.

2. Connect electrical power to the range.

Troubleshooting



Problem	Possible Causes	What To Do
Top burners do not light or do not burn evenly	Plug on range is not completely inserted in the electrical outlet.	Make sure electrical plug is plugged into a live, properly grounded outlet.
	Burner hole or slits on the side of the burner may be clogged.	Remove the burners (on models with standard twin burners) or burner heads and caps (on models with sealed burners) and clean them with a sewing needle or twist-tie. Make sure you do not enlarge the holes. On sealed burner models, check and clean the electrode area for burned-on food or grease.
	Improper burner assembly.	Make sure the burner parts are installed correctly. See the Care and cleaning of the range section.
Burner flames very large or yellow	Improper air to gas ratio.	If range is connected to LP gas, contact the person who installed your range or made the conversion.
Surface burners light but oven does not	The oven gas shut-off valve may have accidentally been moved during cleaning or moving.	<p>To check the oven gas shut-off valve on sealed burner models, remove the storage drawer or kick panel (see the Care and cleaning of the range section) and look for the gas shut-off lever at the back of the range.</p>  <p>Sealed burner models</p> <p>To check the oven gas shut-off valve on standard twin burner models, raise the cooktop and look for the gas shut-off lever at the extreme right rear corner. Follow the directions in box A or B that match your regulator type.</p>

		
Control signals after entering cooking time or start time (on some models)	You forgot to enter a bake temperature or cleaning time.	Touch the Bake pad and desired temperature or the Self Clean pad and desired clean time.
Clock and timer do not work	Plug on range is not completely inserted in the electrical outlet.	Make sure electrical plug is plugged into a live, properly grounded outlet.
	A fuse in your home may be blown or the circuit breaker tripped.	Replace the fuse or reset the circuit breaker
	Oven controls improperly set.	See the Using the clock and timer section.
Food does not bake or roast properly	Oven controls improperly set	See the Using the oven section.
	Rack position is incorrect.	See the Using the oven section.
	Incorrect cookware or cookware of improper size being used.	See the Using the oven section.
	Oven thermostat needs adjustment.	See the Adjust the oven thermostat —Do it yourself! section.
	Clock not set correctly.	See the Using the clock and timer section.
	Aluminum foil used improperly in the oven.	See the Care and cleaning of the range section.
	Oven bottom not securely seated in position.	See the Installation of the range section

Food does not broil properly	Oven controls improperly set.	Make sure you touch the Broil Hi/Lo pad.
	Oven door not closed.	See the Using the oven section.
	Improper rack position being used.	See the Broiling Guide.
	Food being cooked in a hot pan.	For best results, use a pan designed for broiling. Make sure it is cool.
	Cookware not suited for broiling.	For best results, use a pan designed for broiling.
	Oven bottom not securely seated in position.	See the Installation of the range section.
Oven temperature too hot or too cold	Oven thermostat needs adjustment.	See the Adjust the oven thermostat —Do it yourself! section.
Oven light does not work	Light bulb is loose or defective.	Tighten or replace the bulb.
	Plug on range is not completely inserted in the electrical outlet.	Make sure electrical plug is plugged into a live, properly grounded outlet.
Oven will not self-clean	The oven temperature is too high to set a self-clean operation.	Allow the range to cool to room temperature and reset the controls.
	Oven controls improperly set.	See the Using the self-cleaning oven section.
	On models with a door latch, the oven door is not in the locked position.	Make sure you move the door latch handle all the way to the right.
“Crackling” or “popping” sound	This is the sound of the metal heating and cooling during both the	This is normal.



	cooking and cleaning functions.	
Excessive smoking	Excessive soil	Touch the Clear/Off pad.
Oven door will not open after a clean cycle	Oven too hot.	Allow the oven to cool below locking temperature.
Oven not clean after a clean cycle	Oven controls not properly set.	See the Using the self-cleaning oven section.
	Oven was heavily soiled.	Clean up heavy spillovers before starting the clean cycle. Heavily soiled ovens may need to self-clean again or for a longer period of time.
Oven door will not unlock (on models with a door latch)	Oven is too hot.	Allow the oven to cool below locking temperature. Do not lock the door with the door latch except when using the self-clean feature.
Self clean light blinks during self clean cycle	A power interruption occurred.	Touch the Clear/Off pad, wait for the oven to cool, and on models with a latch, move it to the left as far as it will go. Reset the range controls to the desired settings. See the Using the self-cleaning oven section.
	Self-cleaning cycle has been selected, but the oven door was not closed, and on models with a latch, it was not moved all the way to the right.	Close the oven door. On models with a latch, move it all the way to the right.
	On models with a latch, it was moved to the right, but a program other than self-cleaning was selected.	Move the latch handle to the right only when setting the self-cleaning cycle.



“F—and a number or letter” flash in the display (on some models)	On models with a door latch, if a function error code appears during the self-cleaning cycle, check the oven door latch.	The latch may have been moved, even if only slightly, from the locked position. Make sure the latch is moved to the right as far as it will go.
	You have a function error code.	Touch the Clear/Off pad. Allow the oven to cool for one hour. Put the oven back into operation.
	If the function code repeats.	Disconnect all power to the range for 5 minutes and then reconnect power. If the function error code repeats, call for service.
Display goes blank	A fuse in your home may be blown or the circuit breaker tripped.	Replace the fuse or reset the circuit breaker
	The clock is turned off so that it does not show in the display.	See the Using the clock and timer section.
Display flashes	Power failure.	Reset the clock.
Unable to get the display to show “SF”	Oven control pads were not touched properly.	The Bake and Broil Hi/Lo pads must be touched at the same time and held for 3 seconds.
Power outage, clock flashes	Power outage or surge.	Reset the clock. If the oven was in use, you must reset it by touching the Clear/Off pad, setting the clock and resetting any cooking function.
“Burning” or “oily” odor emitting from the vent	This is normal in a new oven and will disappear in time.	To speed the process, set a self-clean cycle for a minimum of 3 hours. See the Using the self-cleaning oven section.
Strong odor	An odor from the insulation around the inside of the oven is	This is temporary



	normal for the first few times the oven is used.	
Fan noise	A cooling fan may automatically turn on and off to cool internal parts.	This is normal. The cooling fan will turn off and on.
Drawer does not slide smoothly or drags	The drawer is out of alignment.	Fully extend the drawer and push it all the way in.
	Drawer is over-loaded or load is unbalanced.	Reduce weight. Redistribute drawer contents.

Warning

This content is compiled from multiple sources and is provided for reference purposes only. It may not be complete or fully applicable to all situations. If you are unable to resolve your issue, please contact the product manufacturer or an authorized service provider for official support.

