

Getting to know your machine

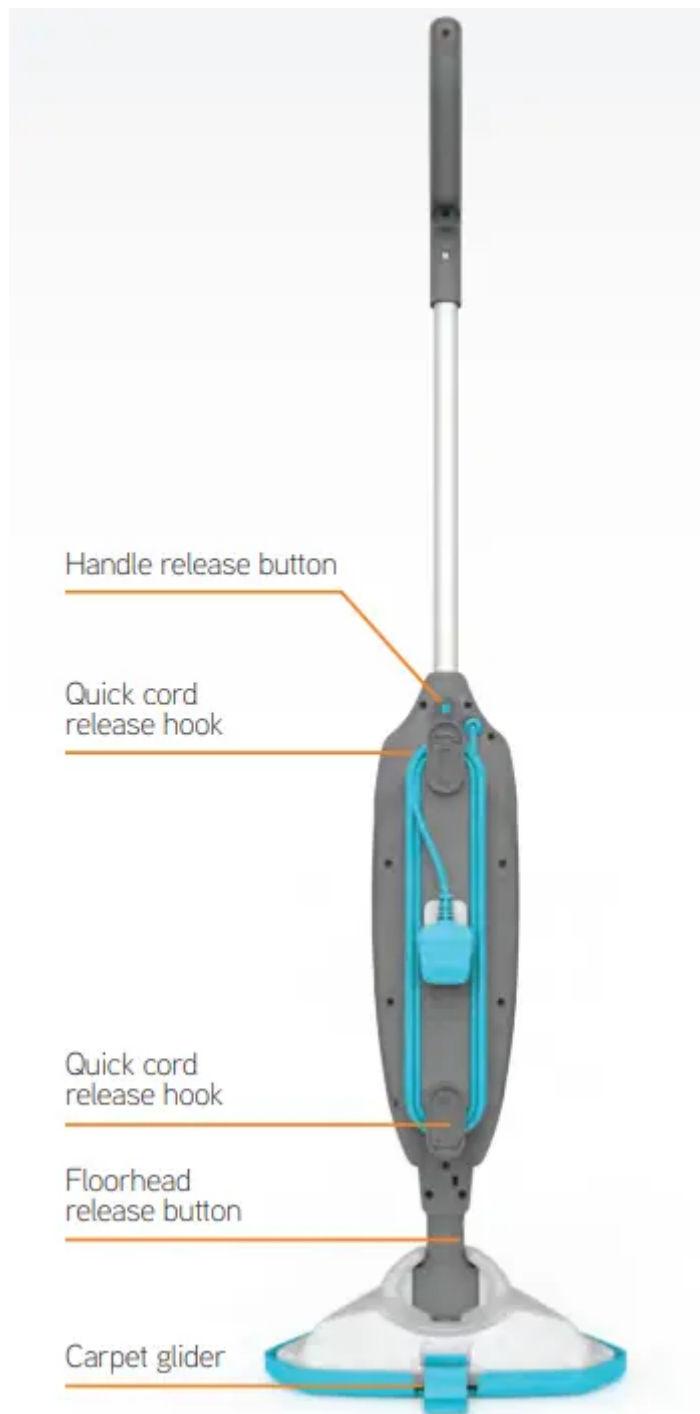



Technical Specification

Name Steam Fresh

Voltage 220-240

Wattage 1400-1600w

Cord length 7m Weight 3kg



Getting started

PLEASE READ 'LET'S TALK SAFETY' AT THE BEGINNING BEFORE USE

Assembling your steam mop

Push the main body down into the floor head until it clicks into place

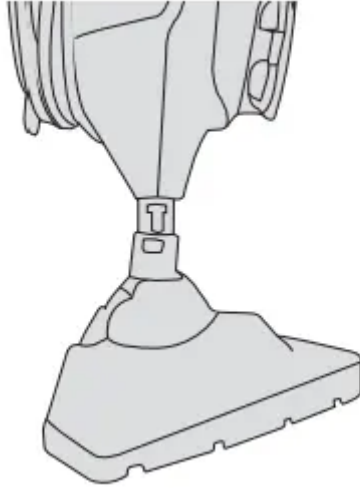

Stand the steam mop upright by pushing the main body forward to lock into position

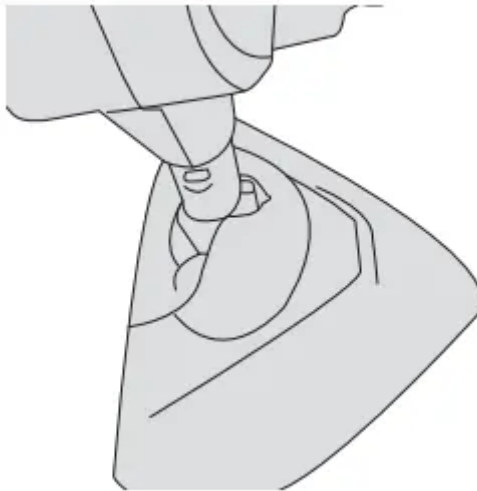

Push the handle into main body until it clicks into place

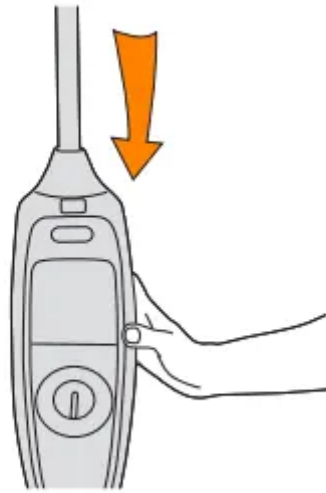

Wrap power cord around hooks for easy storage



Place the cleaning pad on the floor white side facing up. Place steam mop onto pad making sure the entire pad covers the floor head

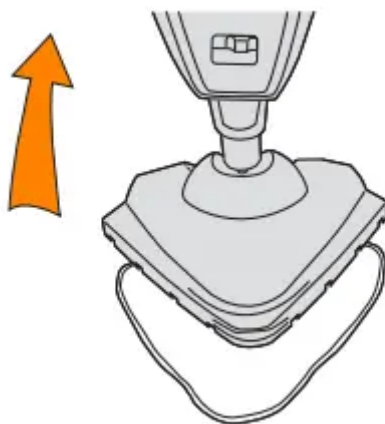

Filling twin tank

Press the twin tank release button and lift the twin tank by the handle

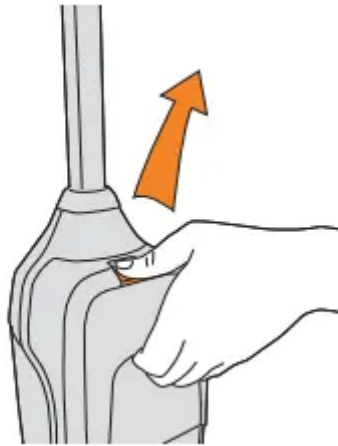

Twist water cap anti-clockwise and lift to remove

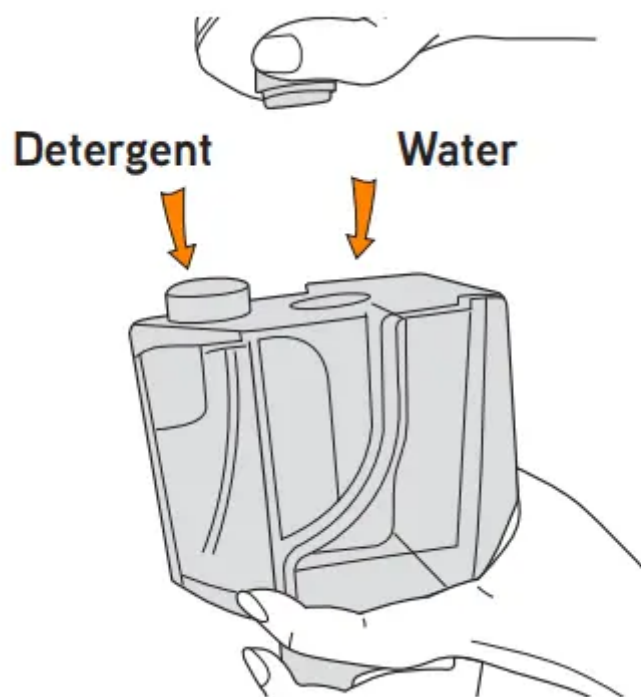

Fill the water tank with 500ml of water, replace cap to tighten and twist clockwise

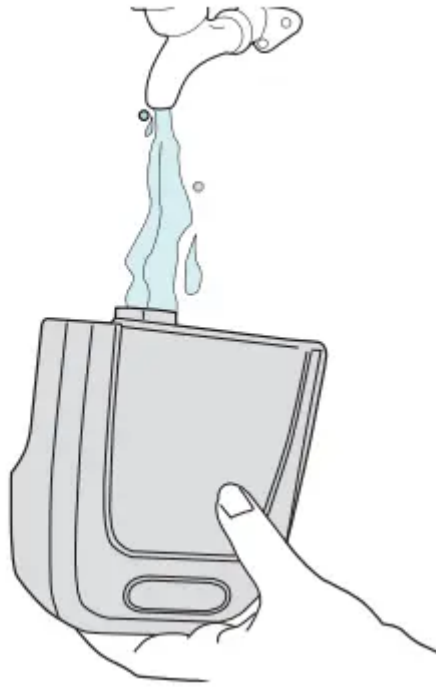

IMPORTANT: If you do not want to use detergent on your flooring, select 'OFF' on the detergent dial. Always test on an inconspicuous area of flooring first before using detergent or steam cleaner.

Twist the detergent cap anti-clockwise and lift to remove

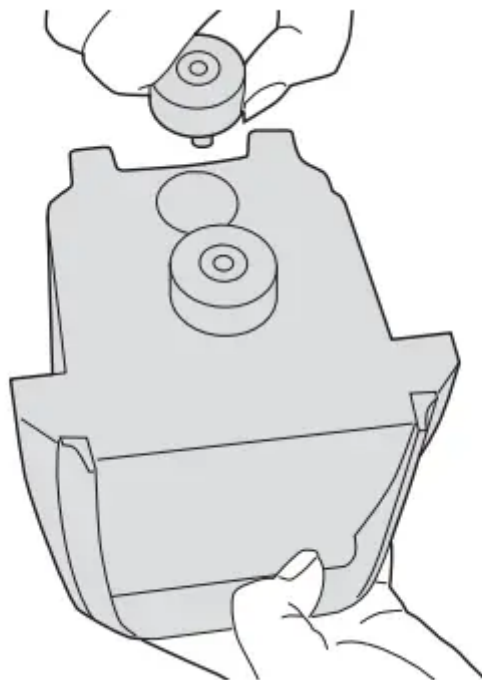

Pour 50ml of Vax detergent and 250ml of water into the detergent tank then replace cap and twist clockwise to tighten

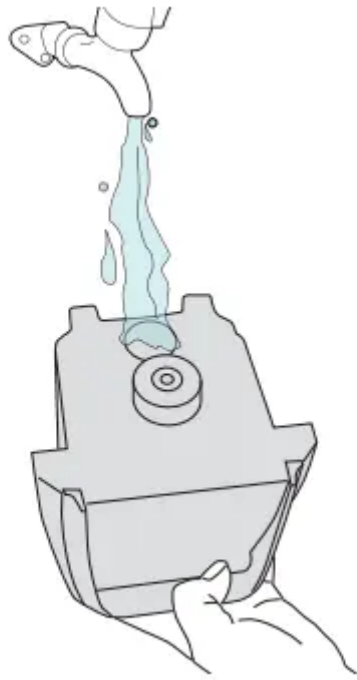

Before replacing the twin tank make sure the hard water filter is in place

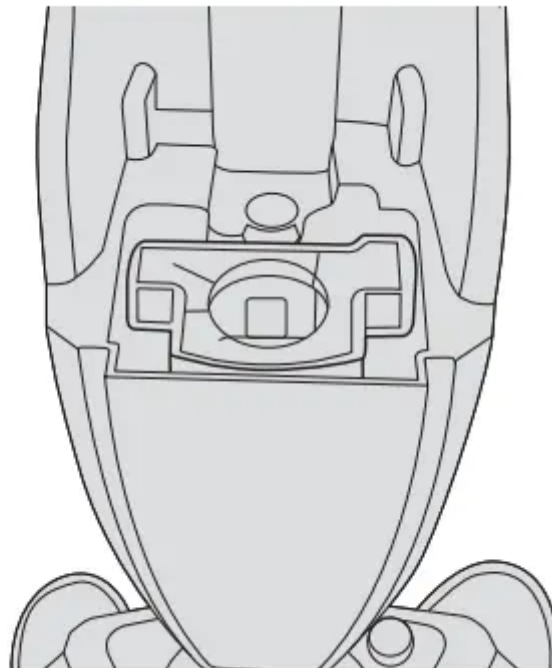

Align the twin tank and push until it clicks into place





Before you begin cleaning

- The steam mop and accessories get very hot during use, always allow them to cool down before handling.
- Always unplug and switch off the steam mop when assembling and filling water and solution tank.
- Always switch off the steam mop before emptying the water tank or changing the cleaning pads/accessories.
- **IMPORTANT:** Please refer to floor manufacturer's care recommendations before use and test the steam mop on a discrete area of flooring to begin with. Check with flooring manufacturer for suitability on sealed floors prior to use.
- When using the steam mop, basic safety precautions should always be observed.
- Don't aim the steam mop at people, animals, plants and electrical components such as interior of ovens or wires. Never touch the steam burst or floor head from a short distance. (There is a risk of scalding)
- The steam mop is equipped with a thermostat and a thermal cut-out. If for any reason the steam mop overheats it will switch off. If this happens turn off and unplug the steam mop, allow to cool for a least 2 to 4 hours and re-start.

Using your machine

Using your machine

Place the microfibre pad on the floor white side facing up. Place the floor head onto the microfibre pad making sure it covers the entire floor head

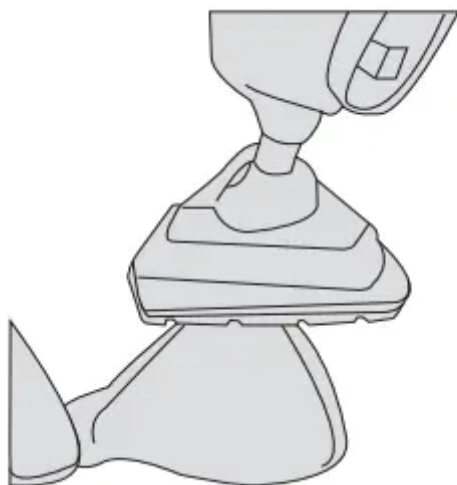

Plug into mains and slide switch to 'ON' position. The blue light will illuminate to show power on. The green light will illuminate to show the steam mop is ready to use

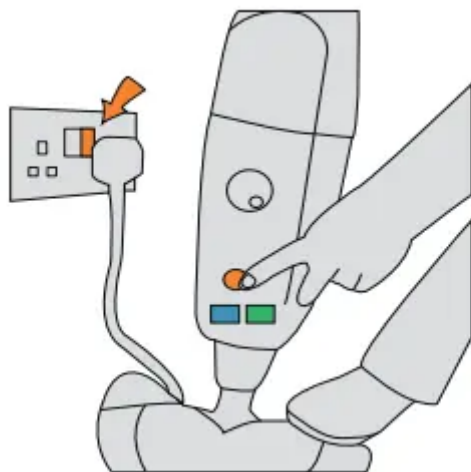

To steam your floors without detergent select 'OFF'. This is generally recommended for carpet and wood flooring

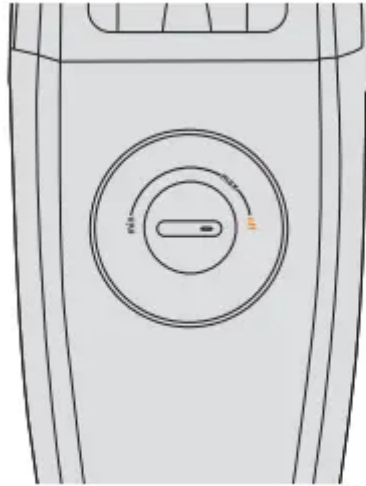

To use with detergent select min to max as desired. This is generally recommended for tile and vinyl flooring

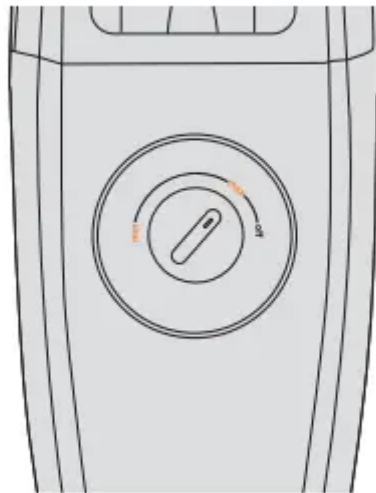

Place your foot onto the floor head and pull handle backwards to recline



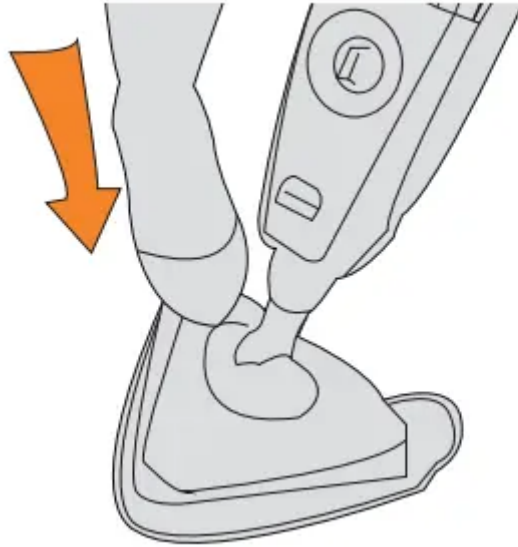

To produce steam, squeeze the trigger. To prevent over wetting floors avoid holding the trigger continuously

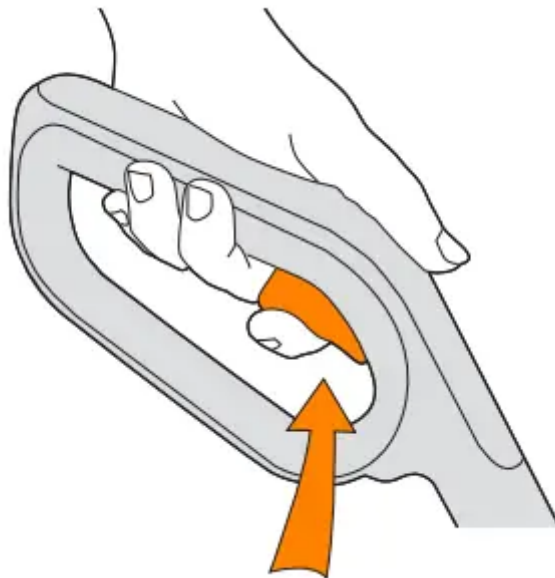

Move the steam mop slowly backwards and forwards paying particular attention to high traffic areas*



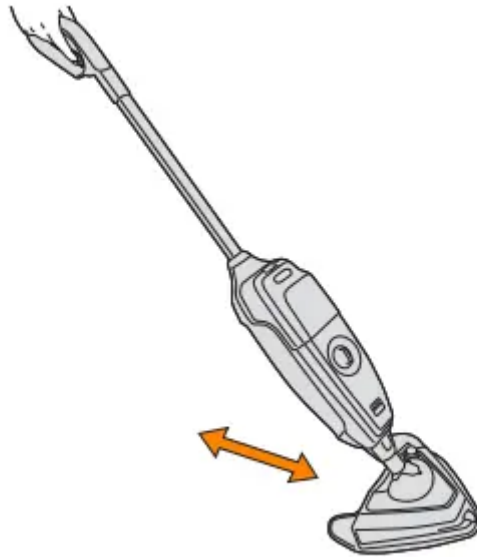

*Never leave the steam mop in one spot on any surface for an extended period of time as this may damage the floor surface.

Refreshing carpets

Place the microfibre pad on the floor white side facing up. Place steam mop onto pad making sure the entire pad covers the floor head

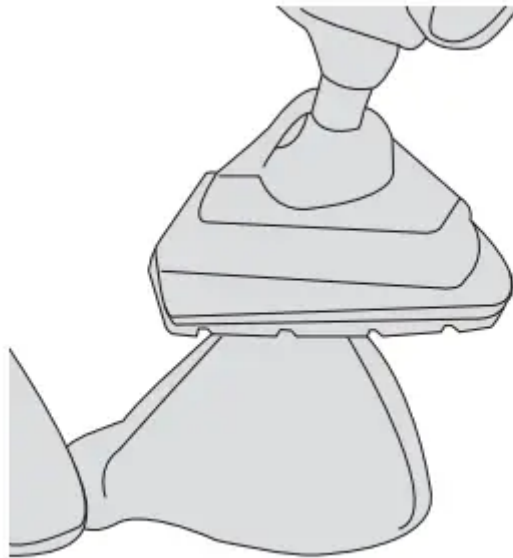

With microfibre pad attached, hook steam mop into the front of the carpet glider and push to clip into place. Carpet glider should only be used when refreshing carpets

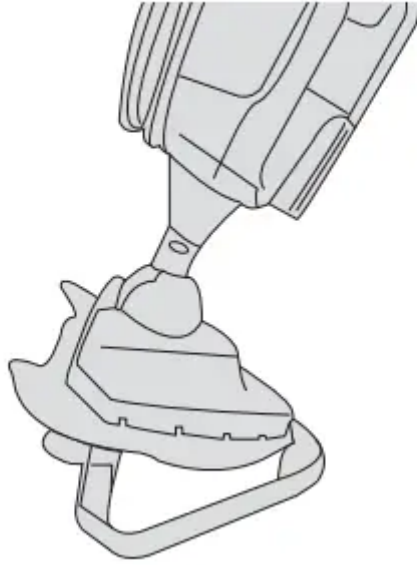

Plug into mains and slide switch to 'ON' position. The blue light will illuminate to show power on. The green light will illuminate to show the steam mop is ready to use

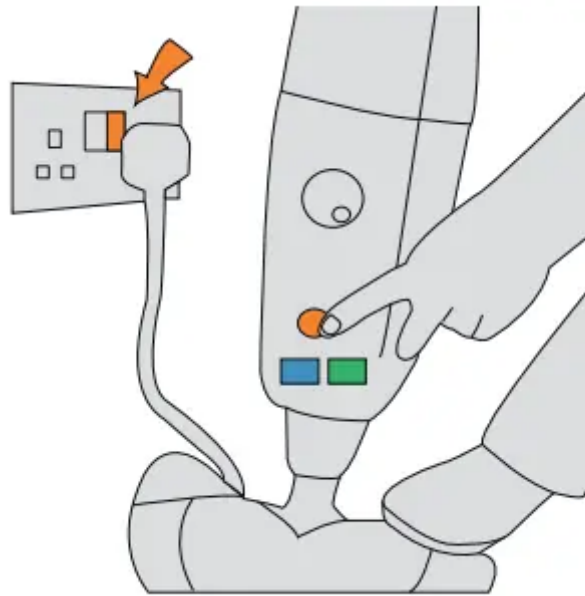

To refresh carpets select 'OFF' setting on the detergent dial

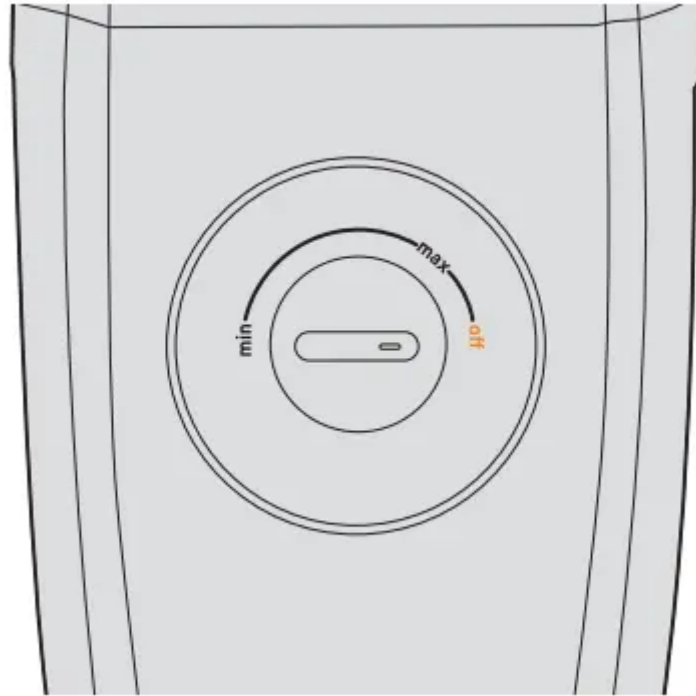

Place your foot onto the floor head and pull handle backwards to recline



To produce steam, squeeze the trigger. To prevent over wetting floors avoid holding the trigger continuously



Move the steam mop slowly backwards and forwards across the carpet paying particular attention to high traffic areas

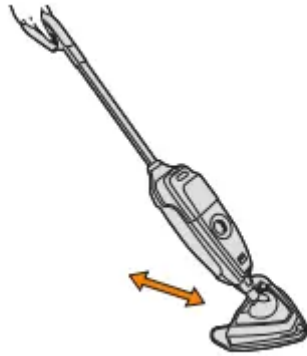

To release the carpet glider, place your foot on clip and push down. Lift steam mop to remove

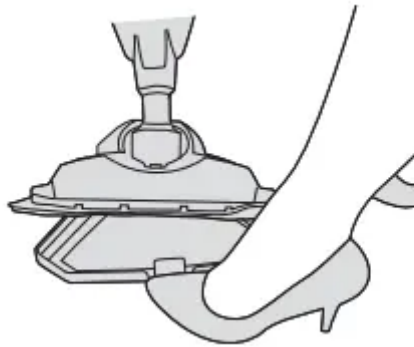

WARNING: Always turn OFF the steam mop when fitting the cleaning pads.

IMPORTANT: Never use the steam mop without a cleaning pad attached to the floor head. Never leave the steam mop in one spot for extended period of time or with a damp or wet pad attached as this may damage the floors surface.

WARNING: When using on carpets, always make sure the microfibre cleaning pad is used and covers the floor head entirely before using the carpet glider. Only use the carpet glider when refreshing carpets.

Taking care of your machine

IMPORTANT: Allow the steam mop to fully cool down before performing any maintenance or troubleshooting checks Don't leave water or detergent in the twin tank between uses, as this can effect the machines performance, the twin tank needs to be emptied and rinsed after each use.

Emptying the twin tank

Press the twin tank release button and lift the twin tank by the handle



Twist water cap anti-clockwise and lift to remove

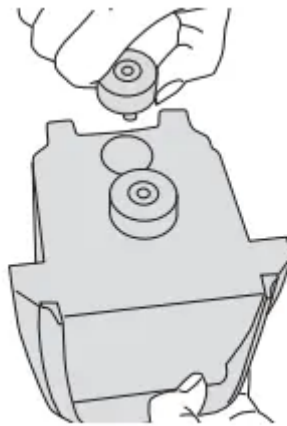

Empty any excess water, replace water cap and turn clockwise to tighten



IMPORTANT: Don't use bleach or fabric softener when washing the microfibre cleaning pad. Always allow the steam mop to fully cool down before removing the microfibre cleaning pad.

Cleaning the microfibre cleaning pad

Hold corner of pad down with foot and lift steam mop to peel away

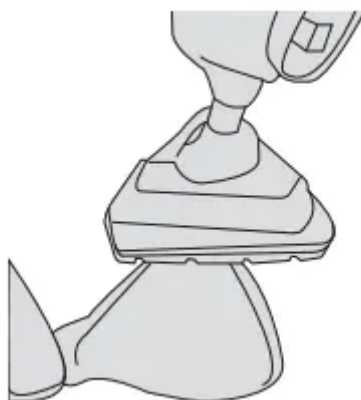

The microfibre pad is machine washable (Max 40°C) allow to fully dry before use

Max 40°C



Storing your steam mop

Wrap the power cord around the quick cord release hooks



IMPORTANT: Don't operate the steam mop without hard water filter in place. The condition of the filter affects the performance of your machine, check and change filter periodically. If you live in an area of hard water the filter will discolour or darken over time. Depending on water hardness and frequency of use, the filter should be changed every 3 to 6 months or if the filter has discoloured.

Replacing the hard water filter

Remove twin water tank to access the hard water filter

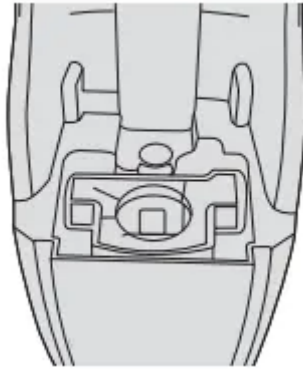

Lift to remove the hard water filter

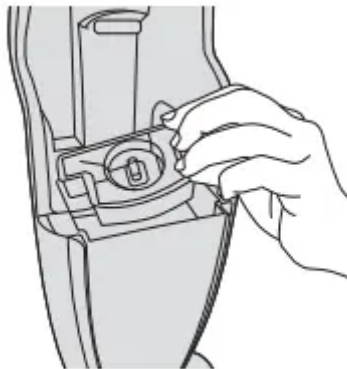

New filter - (beige/cream colour)

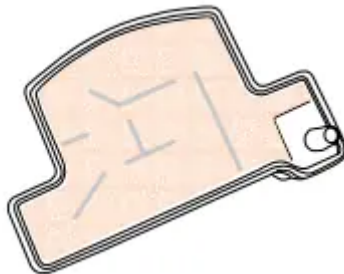

Hard water filter should be replaced every 3-6 months or when discoloured and darkened (dark orange)

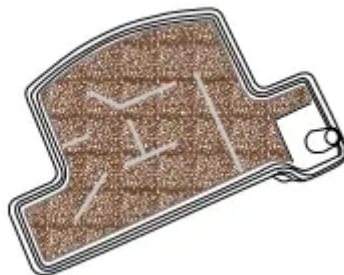

Clearing blockages

If there is an obstruction to the steam flow through the machine, steam may be released through the bleed valve*

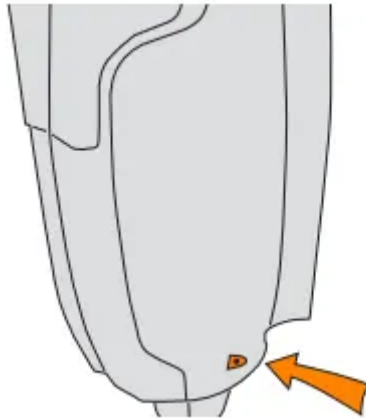

To remove the floor head from main body push the plastic clip and lift

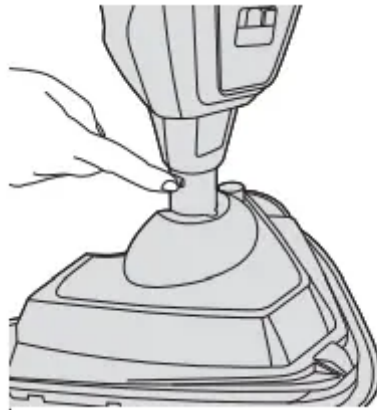

After floor head is removed, using a thin object such as a paper-clip (in the area shown), insert to remove the blockage*

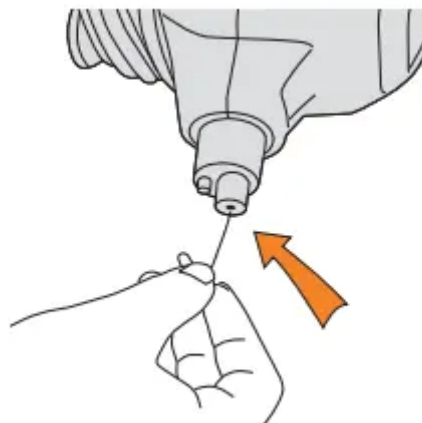

*Ensure steam cleaner is completely cool before clearing blockages

Remove cleaning pad and inspect steam mop base for blockages. If a blockage can be seen use a small thin object such as a paper-clip insert to remove



What to do if it goes wrong

Problem	Solution
There is an accessory missing	<ul style="list-style-type: none"> • Check the 'This pack contains' panel on the box to make sure the part is included with your steam mop.
The steam mop won't turn on?	<ul style="list-style-type: none"> • Check the On/Off switch is in the On position • The plug may not be fully pushed into the electrical socket. • Check the fuse in the plug if this needs replacing.
Why is the steam mop not producing steam/detergent?	<ul style="list-style-type: none"> • There may be no water in water tank, check the water tank has water. • Check the water tank is securely fitted and the hard water filter is in place. • Hard water filter may be blocked or discoloured and needs to be replaced. • The water may not yet be at temperature, the green indicator light will be illuminated when its ready • Steam path may be blocked. Go to 'Let's talk technical' page. • Putting detergent into the water tank can cause damage to the steam mop. • Check correct setting has been selected, to use detergent selected vinyl or tile. • Check the detergent has been diluted to correct strength
Why won't the cleaning pad pick up dirt?	<ul style="list-style-type: none"> • The cleaning pad may already be saturated or dirty, wash the cleaning pad. Go to the 'Taking care of your machine' pages.
Why is steam coming from the side of the steam mop?	<ul style="list-style-type: none"> • Steam coming from the side of the machine indicates a blockage within the machine. To clear any blockages go to the 'Taking care of your machine' pages.

Warning: Always unplug the steam mop before performing maintenance/troubleshooting checks

Warning

This content is compiled from multiple sources and is provided for reference purposes only. It may not be complete or fully applicable to all situations. If you are unable to resolve your issue, please contact the product manufacturer or an authorized service provider for official support.

Document generated by [ManualsFile](#)