



Connections and Setup

TV Buttons



Power button

If the batteries in your remote control are run down, you can use the button on your TV set. The model has only one  button. It may work just as Power on/Standby button, or as a multi-function controller. You can turn on the TV by pressing the  button on the TV set. While the TV is on, press the  button to display the multi-function menu. More information about how to use the multi-function menu, please refer to the figure below.

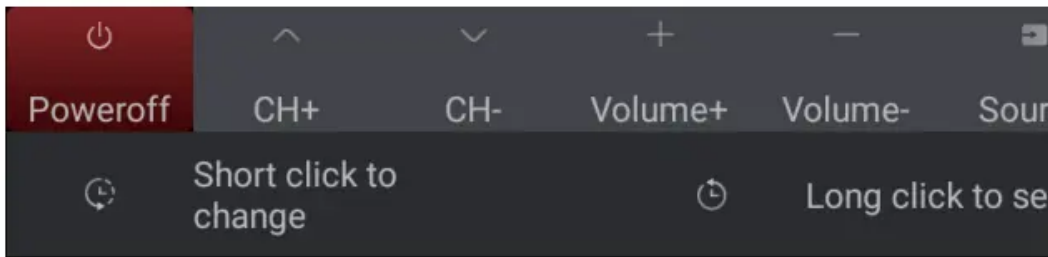

- Press to move the highlight to the next function selection
- Press and hold the button for more than 2 seconds to confirm your selection



MIC switch ON

The MIC switch is located next to the power button. If you want to use the feature of hands-free TV voice control, turn on the switch (not available for some models).

Initial Setup

The first time you switch the set on, the Welcome wizard appears, which guides you through the initial setup process. Follow the on-screen instructions to finish the initial setup process such as selecting the language, connecting to the network, and more. During each step, either make a choice or skip the step. If you skip a step, you can perform the setup later from the settings menu.

Sockets

HDMI, HDMI(ARC) or HDMI(SERVICE) socket (input)

The HDMI (High-Definition Multimedia Interface) socket can be used to connect a Blu-ray player, PC with a compatible video card installed, certain DVD players or a high-definition compatible digital satellite decoder. This socket provides an uncompressed digital connection that carries both video and audio data by way of an integrated mini-plug cable.

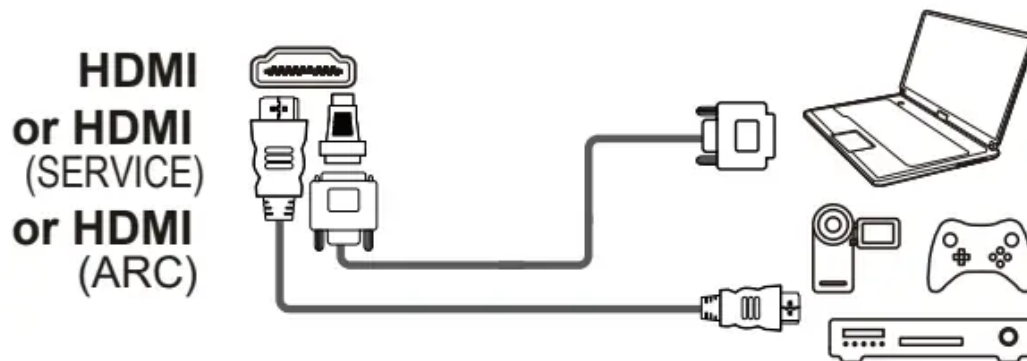

AV IN adapter socket

The AV IN adapter socket can be used to connect the attached AV adapter cable with VIDEO and AUDIO L & R IN sockets. The AV IN sockets can be used to connect a range of equipment, including video recorders, camcorders, decoders, satellite receivers, DVD players, or games consoles. The VIDEO IN socket provides composite video connection.

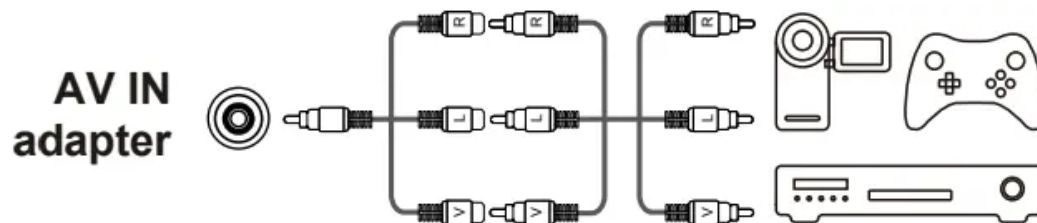

ANTENNA IN socket (input)

This socket can be used to connect an outside aerial.



LAN

RJ45 plug for connecting to external modem or network access equipment.



DIGITAL AUDIO OUT (OPTICAL) socket

This socket can be used to connect a compatible digital audio receiver.

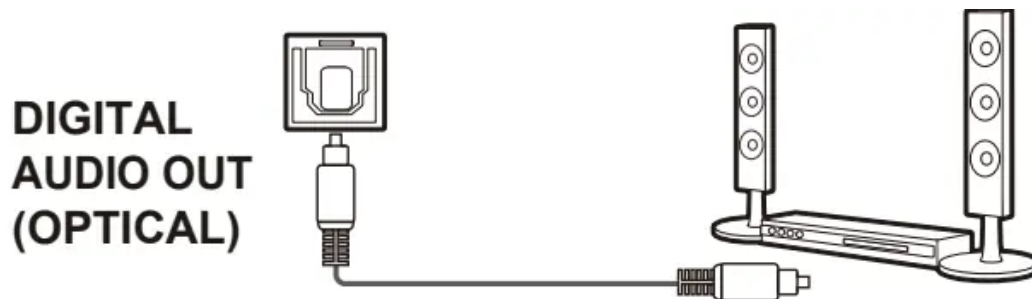

Headphone socket (output)

This socket can be used to connect headphones or stereo earphones. Warning: Excessive sound pressure from earphones and headphones can cause hearing loss.



USB2.0 socket (input)

These sockets can be used to connect a USB 2.0 device. Note: The number of USB sockets on the TV may vary according to TV model.

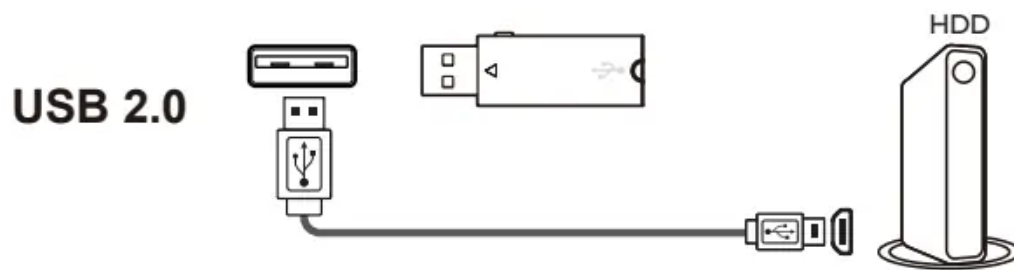

Remote Control Functions





To switch the sound off and back on



Standby / quit standby

Numeric buttons To enter channel numbers or a digit.



To access T-Channel.

LIST

To display the channel list.

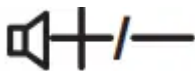

To control the volume.





To display programme information, if available.



To display the TV settings menu.

 To change channels.

 To access the Smart TV homepage.

 To display the Option menu.

 Navigation direction buttons.

OK To confirm an entry or selection.

 To return to the previous menu or quit an app.

 To select input source.

EXIT To exit the Settings menu.

 **LANG** To select an audio language available for selected digital TV programme.

GUIDE To toggle the Electronic Programme Guide on or off . (only available for digital channels.)

TEXT To toggle Teletext on or off

SUBT. To select a subtitle language available for selected digital TV programme.

Colour buttons To select tasks or Teletext pages; to be used for HbbTV function.

 To start fast reverse.

 To pause playback.

 To start fast forward.

 **REC** To record programmes under DTV source.

 To start playback.

 To stop playback.

NETFLIX

To access the NETFLIX application. (Not available for some models.)

Installing Batteries

1. Push to open the back cover as illustrated.
2. Insert two AAA batteries according to the polarities marked on the battery case.
3. Replace the back cover as illustrated.

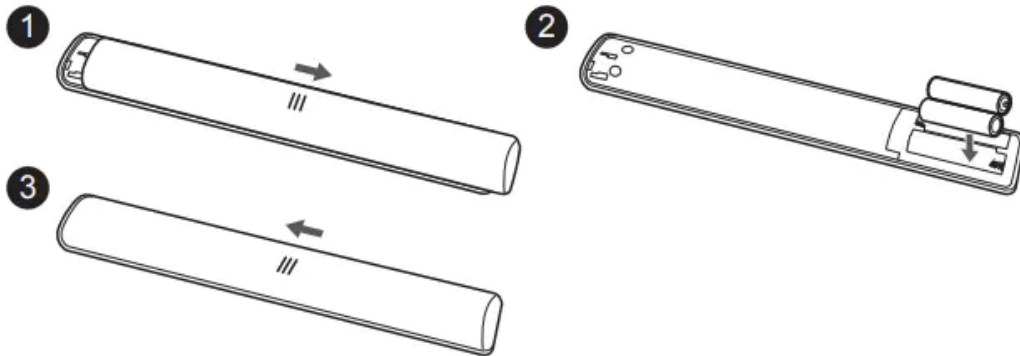

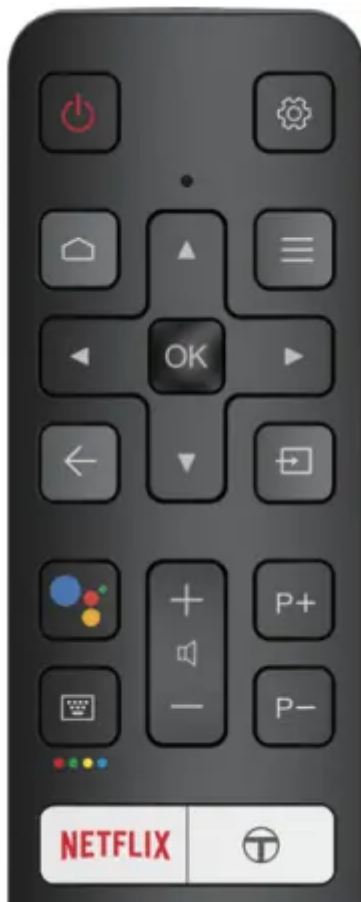

Exclusive Remote Control



 Standby / quit standby..

 To display the TV settings menu.

 To access the Smart TV homepage.

 To display the Option menu.

 Navigation direction buttons. The ▲/▼ buttons are also ..used to change channels in TV mode.

OK To confirm an entry or selection. The button is also used to ..display the channel list in TV mode.

 To return to the previous menu or quit an app.

 To select input source.

 Press the Assistant button on your remote to talk to the Google ..Assistant. (Available only when the network connection works ..normally.)

 To pop up the virtual remote control keyboard when available.

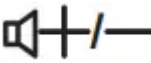
 To control the volume.

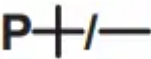
 To change channels.

NETFLIX To access Netflix. (Not available for some models.)

 To access T-Channel.

How to Use the Remote Control

When using the Google Assistant button for the first time, you will be prompted to pair the remote with the TV.

- a. Keep the remote control and TV in 1 meter, please follow the on-screen guide for pairing instructions. You can use the Google Assistant button after activating successfully.
- b. The Google Assistant is only available for content search from certain apps.
- c. Set languages in the Settings to your local language or official language to enhance voice search successfully

Installing Batteries

1. Push to open the back cover as illustrated.
2. Insert two AAA batteries according to the polarities marked on the battery case.
3. Replace the back cover as illustrated.

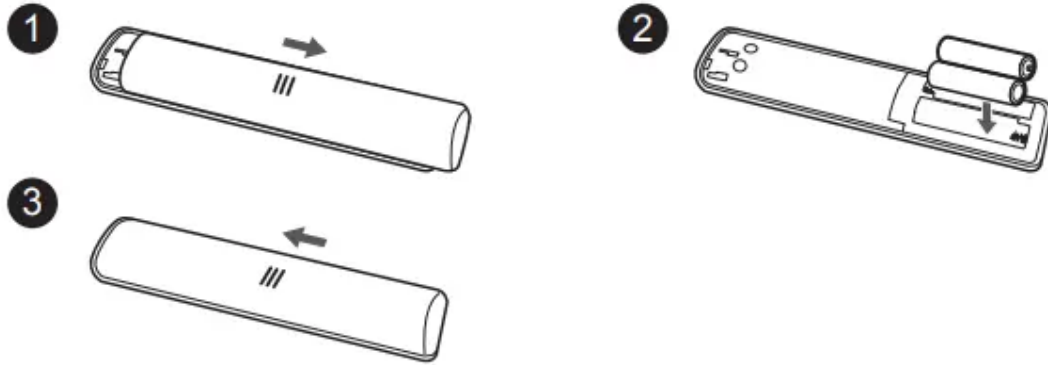

Network Connection

Connecting to a wired Network

To connect to a wired network:

1. Ensure you have:
 - An Ethernet cable long enough to reach your TV
 - A router or modem with an available Ethernet port
 - A high-speed internet connection
 - An Ethernet (LAN) port on the back of the TV
2. Connect your Ethernet cable to the router and to the Ethernet port on the back of the TV.
3. Use the Network & Internet menu to configure the TV.

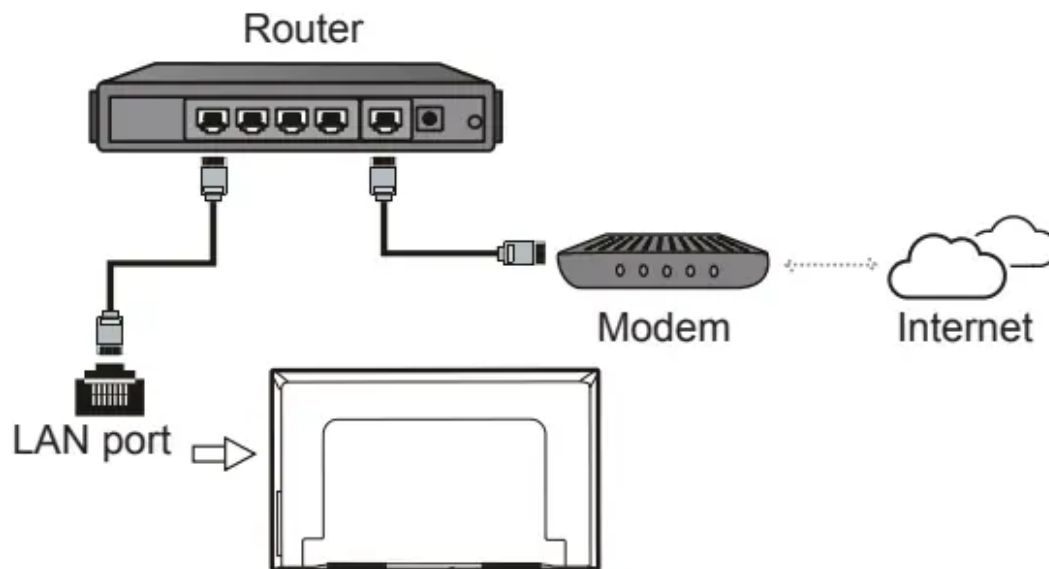

Connecting to a Wireless Network

To connect to a wireless network

1. Ensure you have:
 - A router broadcasting a high-speed wireless signal
 - A high-speed internet connection
2. Use the Network & Internet menu to configure the TV.

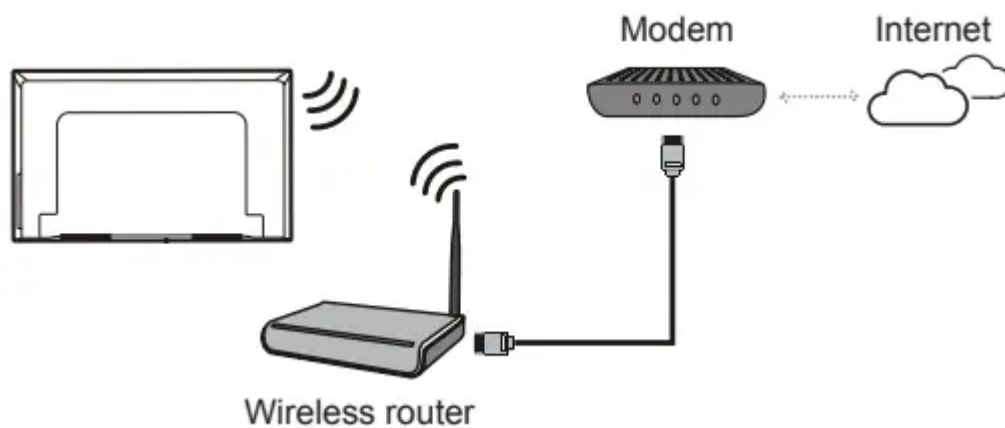

Switching On

Follow the instructions on this page on how to switch on your TV set and the remote control before going on to following pages describing how to use the channel set-up procedure.

1. Insert two AAA batteries in the remote control. Precautions on using batteries:
 - Only use the battery types specified.
 - Make sure you use the correct polarity.

- Do not mix new and used batteries.
- Do not use rechargeable batteries.
- Do not expose batteries to excessive heat such as sunshine, fire or the like, throw them in a fire, recharge them or try to open them, as this could cause them to leak or explode.
- Remove the batteries from the remote control if you are not using it for a long period of time.
- Attention should be drawn to the environmental aspects of battery disposal.

2. Connect the power cable FIRST to the television, THEN to a mains socket. (Note: if the power cable is connected to the television, please only connect the power cable to the mains socket.) Your TV set should only be connected to an AC supply. It must not be connected to a DC supply. If the plug is detached from the cable, do not, under any circumstances, connect it to a mains socket, as there is a risk of electric shock.

Note: the figures are for representation only, the location of power socket of the television might differ depend on the model.

3. Connect an outside aerial to the ANTENNA IN socket at the back of the TV set. The aerial socket (75 OHM - VHF / UHF / cable) can be used for connecting an external aerial or other equipment fitted.

Note: if you want to receive the signal from your cable or cable box, please connect a coaxial cable to the ANTENNA IN socket at the back of the TV set.

4. When powered on, the TV will be turned on directly or be in standby mode. If the power indicator lights up, the TV set is in standby mode. Press the  button on the remote control or on the TV set to turn on the TV.

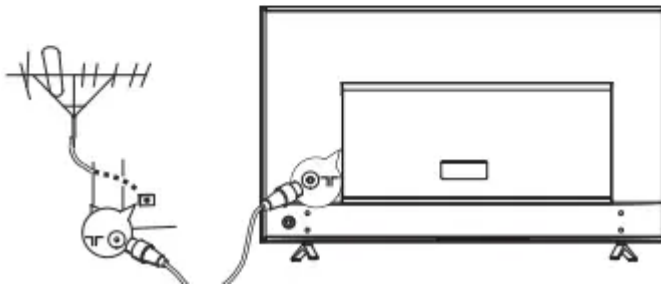
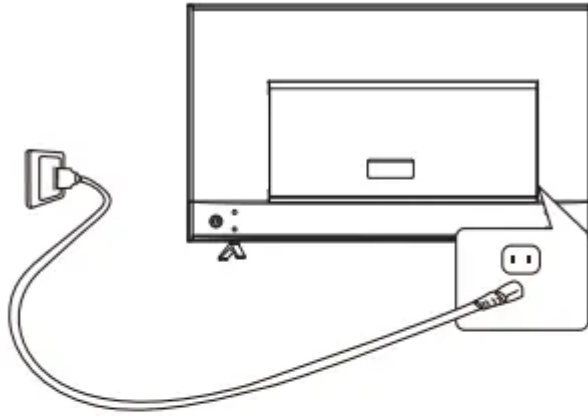

Switching Off

To put the TV set into standby mode, press the  button on the remote control. The TV set remains powered up, but with low energy consumption.



To switch off the TV set, unplug the mains socket from the mains outlet.





Basic TV Operations

Accessing Channels









Using the RC802N Remote Control

Using the numeric buttons: press the corresponding numeric buttons on the remote control to access the channels.



Using the P  buttons: press the P  buttons on the remote control to scroll through the channels.

Using the LIST button: press the LIST button to display the channel list and press  /  /  /  and OK to select channels.

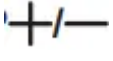
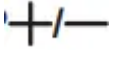

Using the RC802V Remote Control





Using the  /  buttons: press the  /  buttons on the remote control to scroll through the channels. Using the OK button: press the OK button to display the channel list and press  /  /  /  and OK to select channels.

Using the P  buttons: press the P  buttons on the remote control to scroll through the channels.

Using the  button: press  to display the virtual remote control keyboard, then you can use the numeric buttons or the LIST button to operate accordingly.



Watching Connected Devices

Press  on the remote control to display the source list. Press  to select TV or other input sources and press OK to confirm.

You can also press  on the remote control to display the homepage, press  to move the cursor to the  (Inputs) area on the right top of the screen, and press OK to enter. Then press  and OK to select the input source.

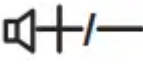
Adjusting Volume

Volume control: press the  buttons on the remote control or the corresponding buttons on the TV set to increase or decrease the volume.

Sound mute: press the  button to temporarily mute the sound. Press this button again or the  button to restore the sound. (Available for RC802N remote control only.)

Accessing Smart TV Homepage



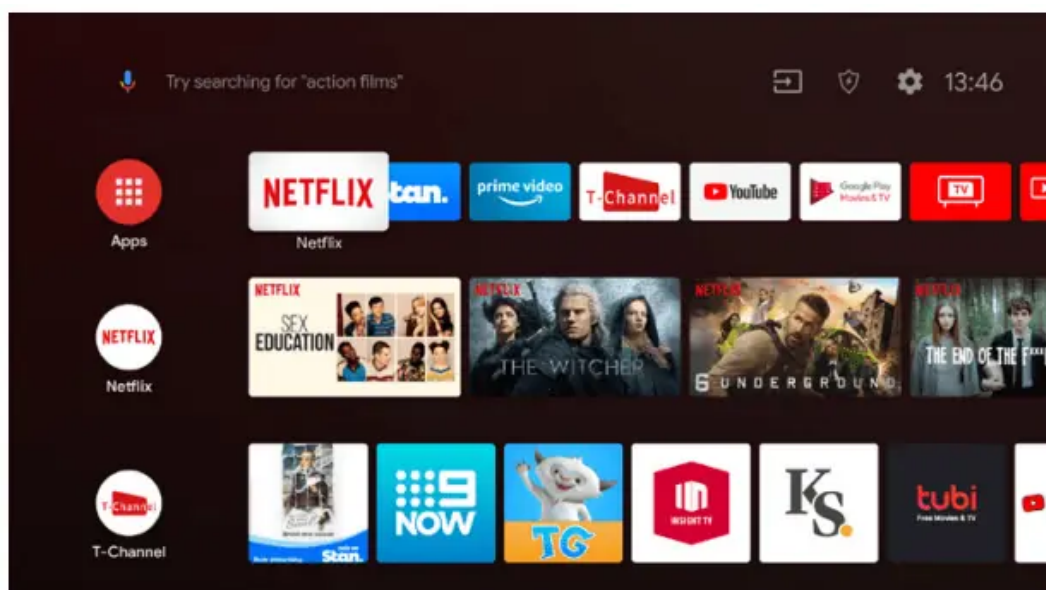

Allows you to enjoy Internet Applications (Apps) and specially adapted Internet websites, and perform system settings for your TV. You can make controlling with the TV remote control.

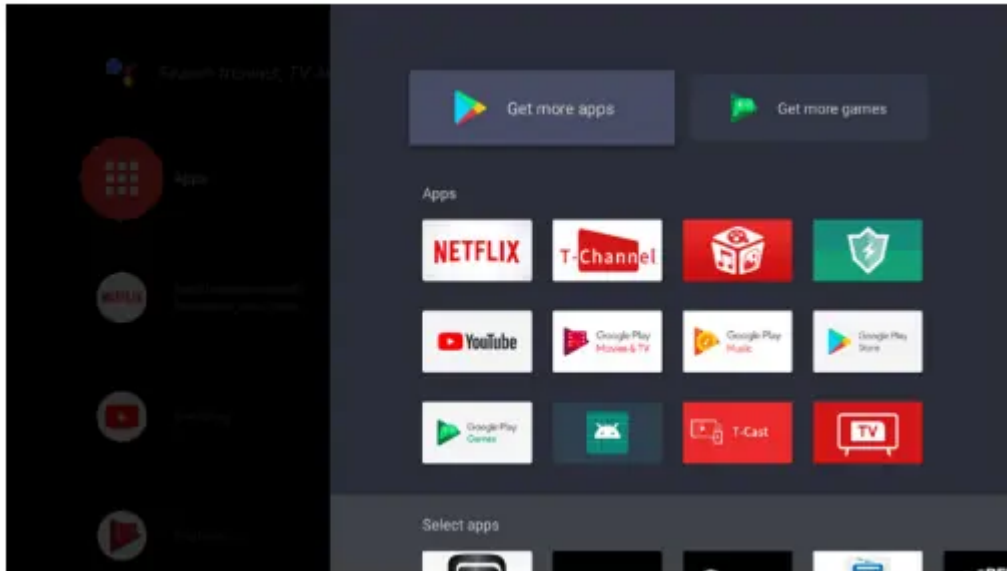

Accessing Google Play

Google Play is your entertainment unbound. It brings together all of the entertainment you love and helps you explore it in new ways, anytime, anywhere. We've brought the magic of Google to music, movies, TV, books, magazines, apps and games, so you get more from your content every day







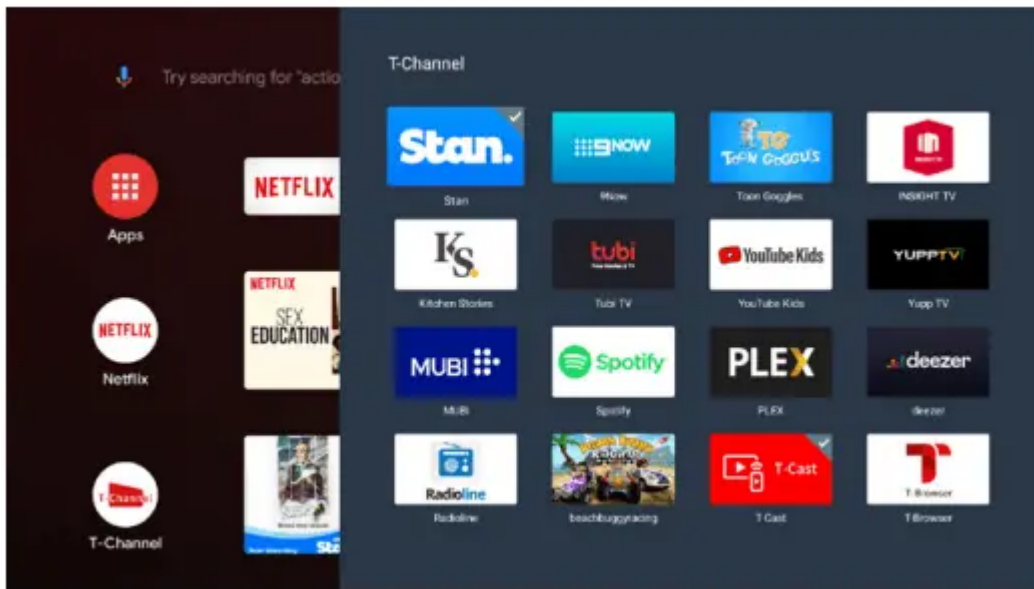

1. Press  on the remote control to display the Smart TV homepage.
2. Press  to select the Apps, and press OK to enter. Then press  and OK to enter the desired apps.
3. Press  to return to the homepage.

Accessing T-Channel

Allows you to enjoy Internet Applications (Apps)





1. Press  on the remote control to display the recommended apps.
2. Press  /  /  /  and OK to enter the desired apps. For the first time, the apps will be downloaded automatically.
3. Press  to return to the recommend page and exit.

Using System Settings Menu

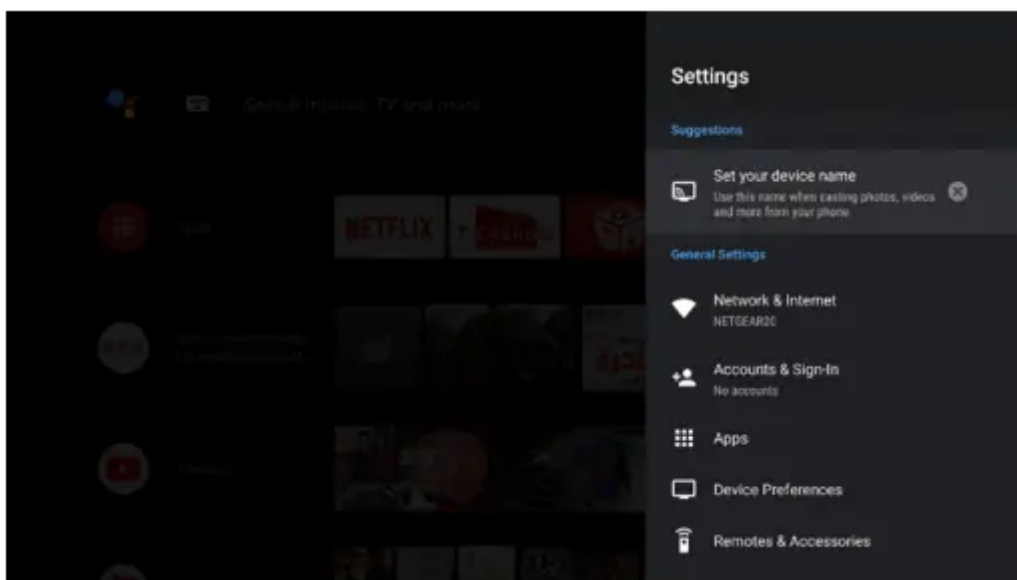
Allows you to not only adjust device settings, such as Network & Internet, Accounts & Sign-In, Apps and Device Preferences, etc., but also set preferences.





1. Press  on the remote control to display the Smart TV homepage.

2. Press ▲/◀/▶ to move the cursor to  (Settings) on the right top of the screen and press OK to enter the system settings.
3. Press ▲/▼ to choose the items and press OK to enter.
4. Press  to return to previous interface.
5. Press EXIT to close the menu.

Using Instant Power On

It enables you to turn on your TV faster from standby mode than turning this function off, but it will also increase standby power consumption.

1. Press  on the remote control to display the homepage, Press ▲/◀/▶ to select  (Settings) > Device Preferences > Power > Instant power on and press OK to toggle between On and Off.
2. Press  to return to previous interface.

Using TV Settings Menu

Allows you to adjust TV settings, such as picture and sound.

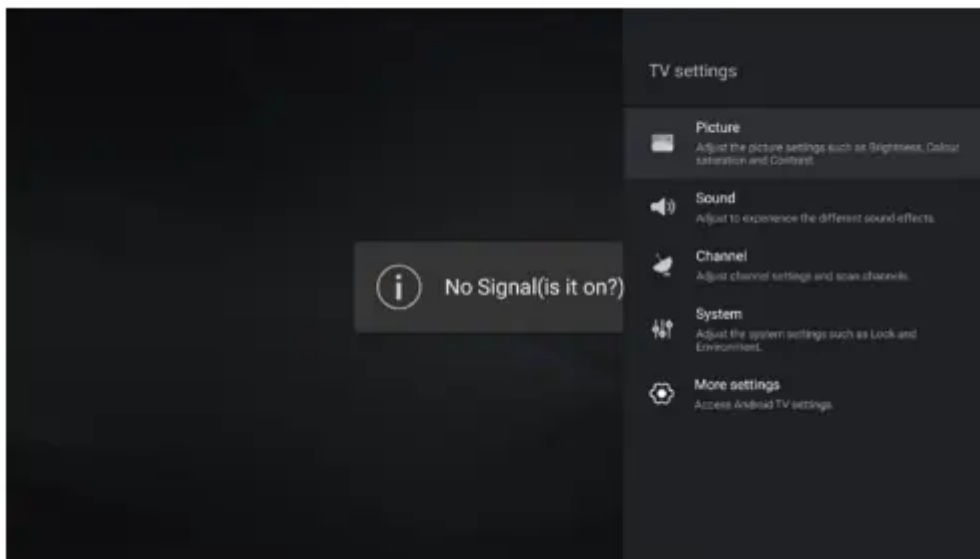

1. Press  on the remote control to display the TV settings menu.
2. Press ▲/▼ to select the desired item, then press OK/▶ to enter the corresponding submenu.

3. In submenus, press ▲/▼ to select menu options, then press OK/▶ to enter the option list, the adjustment interface, or the corresponding submenu.

4. Press  to return to the previous menu.

5. Press EXIT or  to close the menu.

Using more of your TV

Installing Channels

This section describes how to search and store channels automatically. This may be done in any of the cases below:

- you are prompted that there are no channels in TV mode;
- you want to update your channels.

1. In TV mode, press  on the remote control and select Channel > Channel scan. Press OK/▶ to enter.

2. The TV installs and arranges channels according to your country or region. Press ▲/▼ to select Country/Region, and press OK/▶ to enter. Enter the default password 1234 or your own password in case you have changed the password in the System > Lock menu. Press ▲/▼ to select your country or region and press OK to confirm.

3. Press ▲/▼ to select Automatic search and press OK/▶ to enter.

4. Press ▲/▼ to select Channel type and press ◀/▶ to select Digital, Analogue or Digital&Analogue.

5. After configuration is completed, press ▼ to select Search and press OK to start scanning channels.



6. The channel search may take a few minutes. After the automatic search, channels are arranged in a preset order. If you wish to hide or move channels,

press  on the remote control, select Channel > Channel organizer and press OK/▶ to enter



Using Subtitles

You can enable subtitles for each TV channel. Subtitles are broadcast via Teletext or DVB-T digital broadcasts. With digital broadcasts, you have the additional option of selecting a preferred subtitle language.

Turning On/Off Subtitles



1. Press  on the remote control, select Channel > Subtitle and press OK/▶ to enter.
2. Select the Subtitle option, and press OK to toggle between on or off.
3. Press EXIT or  to close the menu.

Enabling Subtitle Languages on Digital TV Channels

1. Press  on the remote control, select Channel > Subtitle > Digital subtitle language 1st and press OK/▶ to enter.
2. Press ▲/▼ to select a subtitle language as your preferred language and press OK to confirm.
3. Press ▲/▼ to select Digital subtitle language 2nd and press OK/▶ to enter.
4. Press ▲/▼ to select a secondary subtitle language and press OK to confirm.
5. Press EXIT or  to close the menu.

Shortcut operation: Press SUBT. on the remote control to directly select a subtitle language available for the selected digital TV programme. (Available for RC802N remote control only.)

Selecting a Subtitle Type on Digital TV Channels

1. Press  on the remote control, select Channel > Subtitle > Subtitle type and press OK/▶ to enter.
2. Press ▲/▼ to select a subtitle type and press OK to confirm. You can select Hearing impaired to display the hearing impaired subtitles with your selected language.
3. Press EXIT or  to close the menu.

Using Teletext



Selecting Decoding Page Language

1. Press  on the remote control, select Channel > Teletext > Decoding page language and press OK/▶ to enter.
2. Press ▲/▼ to select a proper type of language in which Teletext will display and press OK to confirm.

3. Press EXIT or  to close the menu.

Digital Teletext Language



On digital TV channels, depending on the broadcaster, you may be able to enjoy a service with multiple initial Teletext pages in different languages. This function allows you to select an available language as primary language, which relates to different initial Teletext pages.

1. Press  on the remote control, select Channel > Teletext > Digital teletext language and press OK/▶ to enter.
2. Press ▲/▼ to select a language and press OK to confirm.
3. Press EXIT or  to close the menu.

Network Wake Up

This function allows you to turn on your TV from standby mode via a network. To use this function, please make sure:

1. Your TV is connected to an effective home network;
2. The desired controller, such as a smartphone, is connected to the same network as your TV;
3. An app which supports network waking up function, such as YouTube, has been installed into the controller;
4. Networked standby is set to On in the Network & Internet menu under

homepage by pressing  >  (Settings) > Network & Internet and use ▼ to select Networked standby and press OK to activate

When the TV is in networked standby mode, you can use the app to wake up the TV remotely

T-Link

Use this function to search for CEC devices connected to the HDMI sockets in your TV and enable auto power on and auto standby between the TV and CEC devices.

Enabling or Disabling T-Link

1. Press on the remote control, select System > T-Link and press OK/▶ to enter.
2. Select the T-Link option, and press OK to toggle between on or off.
3. Press EXIT or to close the menu.

Using Auto Power On

Enables the TV to automatically power on when you power on a CEC device (e.g. DVD) with the device's remote. Press OK to turn it on to enable this function.

Using Auto Standby

Enables all CEC devices to automatically go to the standby mode when you turn off the TV with the TV remote. Press OK to turn it on to enable this function.

T-Cast

T-Cast lets you enjoy plenty of videos, rich of applications, and share great contents on large screen. It also allows you to turn a smart device into a sophisticated remote control, providing more features than your normal TV remote control. You can then control your TV through your smart device. Follow the on-screen instructions to scan the QR code on the TV screen and download T-Cast.

Using EPG (Electronic Programme Guide)

EPG is an on-screen guide that displays scheduled digital TV programmes. You can navigate, select and view programmes.

1. Press  on the remote control, select Channel > EPG and press OK/▶ to enter, or press GUIDE directly (if available) on the remote control, the Programme Guide menu will appear, which allows you to get information about the current or next programme playing on each channel. Navigate through the different programmes using the ▲/▼/◀/▶ buttons on the remote control.

2. Use the related buttons shown at the bottom of the screen to view EPG.

- Programme filter: Programme guide filter for digital TV programmes.

- Press  to display the type list of the programme.
- Navigate through the different types using the ▲/▼ buttons on the remote control.
- Select one or more types, which you want to highlight from the type list, press OK to select or deselect. A checkmark will appear to the right of the type when selected.

- Custom schedule: Press ▲/▼ to select a programme, then press the RED button to set the schedule, press OK to enter and use ▲/▼ to select Schedule reminder or Schedule recording.



- Select date: Press the GREEN button to select date.

- Schedule list: Press the YELLOW button to view your schedule list.



3. Press  to exit EPG.

Bluetooth Function



(* not available for some models) Bluetooth® is a wireless technology standard for exchanging data over short distance between Bluetooth devices. You can connect Bluetooth audio device, mouse or keyboard via the TV.

1. Press  on the remote control, press  to move the cursor to the  (Settings) area on the right top of the screen and press OK to enter.
2. Move to the Remotes & Accessories area, select Add accessory and press OK to enter. The TV will search nearby Bluetooth devices automatically.
3. Select an available device, press OK and follow the guides on the screen to connect it.

Time Shift

(* not available for some models) Allows you to pause, fast forward and rewind live TV, so you don't have to miss any part of your favourite programmes. Before you use the function, connect a USB drive to the TV first. For the first time, you should complete the disk setup for the USB drive. Press  on the remote control and select Time shift, then press OK/▶ to confirm. (Note: this option is available only when Time shift is set to On: press  on the remote control, press  to select Settings > Channel > Time shift, press OK to toggle on.)

1. Follow the directions on the screen to do the disk setup if you use time shift for the first time.
2. After the disk setup is done, time shift will start, and the time shift menu displays on the screen.
3. For later use, press  and select Time shift. press OK to display the time shift menu and operate according to the on-screen prompt.

4. Press  button on the remote control to stop the time shift and exit. (for RC802V, you can find  button on the virtual remote control keyboard.)





- When the time shift menu disappears and only the timing of the time shift remains on the screen, you can press OK to call out the time shift menu.

Quick Access of Time Shift

Insert a USB disk, press PAUSE() on the remote control, it will access time shift automatically. (Available for RC802N remote control only.)

PVR (Personal Video Recorder)

(* not available for some models) Allows you to record your favourite TV programmes. Before you use the function, connect a USB drive to the TV first.

1. Press  on the remote control and select PVR.
2. Press OK/▶ to enter and select Record. It starts to record automatically.
3. Press blue button to access Settings and use ▲/▼/◀/▶ to adjust the recording duration.
4. Press OK or  to stop recording manually, the recorded file will be saved. In normal operation, the recording will stop automatically when the recording duration expires. Note: you can find  and colour buttons on the virtual remote control keyboard for RC802V.
5. In recording, the PVR mini pane will also show on the screen to indicate the recording progress.
6. To watch the recorded programme, exit PVR mode first. Press  and select PVR > PVR list, then select the related record file. Press OK to play. (It is the same if you record a digital radio programme.)

Freeview Plus

Freeview Plus delivers an aggregated TV service that includes an unrivalled 7+ day EPG experience from all the free to air networks in Australia. At the press of a button, Freeview Plus provides users with all the available Catch Up content along with the ability to set reminders and to search for content via genre. Use the following features and don't miss a show:

- A 7+ day easy to use EPG
- All available Catch Up TV content
- Featured recommendations - Ability to browse by genre and search programmes for the next 7 days
- A favourite function with reminders to live and Catch Up programmes

What You Need

Your television must be connected to a high speed broadband internet connection as well as an aerial.

To Launch Freeview Plus

When you are watching TV, you will see a prompt at the top left of the screen. Press the corresponding colour key on the remote control to launch Freeview Plus. Follow the on-screen instructions and use the colour keys, arrow keys and the OK button to navigate.

*Freeview Plus uses HbbTV technology which combines broadcast and broadband. An internet connection is required. Data usage and conditions apply.

HbbTV

HbbTV (Hybrid broadcast broadband TV) is a service offered by certain broadcasters and available only on some digital TV channels. HbbTV delivers interactive television over broadband Internet. These interactive features are added to and enrich the normal digital programmes, and include services such as digital teletext, electronic programme guide, games, voting, specific information related to the current programme, interactive advertising, information magazines, catch-up TV, etc.

To use HbbTV please ensure your TV is connected to Internet and HbbTV is switched on.

HbbTV Access

1. Press  on the remote control, select System > HbbTV settings and press OK/▶ to enter.
2. Press OK to turn it on.
3. When you tune to a digital TV channel that offers HbbTV, this will be signaled to you by an on-screen indication (generally a red button, but other colour buttons may also be used). Press the indicated colour button to open the interactive pages.
4. Use ▲/▼/◀/▶ and the colour buttons to navigate through the HbbTV pages and press OK to confirm.

HbbTV Deactivation

To avoid disturbances that may be caused by HbbTV broadcasting tests, you can turn off the HbbTV function:

1. Press  on the remote control, select System > HbbTV settings and press OK/▶ to enter.
2. Press OK to turn it off to disable it.

Works with Alexa



To use the Works with Alexa function, you will need a device like an Amazon Echo or Amazon Echo Dot (Sold Separately). Set up your Amazon device. Then, on your TV go to the Settings Menu, select System, and select "Works with Alexa". Then follow the on screen prompts. Please note that within the Alexa app on your phone, you will need to enable the TCL Assistant Skill, through the Alexa Skills Menu.

Netflix Settings

Netflix provides on-demand movies and TV shows delivered via the Internet. Netflix is available in certain countries. Unlimited membership is required

Reset Shop

Allows you to reset the TV to factory default settings.

1. Press  on the remote control to display the homepage, Press ▲/◀/▶ to select  (Settings) > Device Preferences > Reset and press OK to enter.
2. Press ▲/▼ to select Factory data reset and press OK to enter. Then select Erase everything and press OK to confirm.
3. Enter 1234 or the PIN according to the on-screen prompt.
4. Select OK and press OK to confirm.
5. The Initial setup wizard appears. Follow the instructions in the section Initial setup.



Password in Parental Control

- The default password is 1234. You can change it to a new one.
- The super password is 0423. If you forget your code, enter the super password to override any existing codes.

Using the Hands-free TV Voice Control

(* not available for some models) Before using the hands-free TV voice control, connect the TV to the network and make sure it can access the Google website first. Then follow the steps below to access.

1. Turn the built-in MIC switch (next to the power button) to on before using this function.
2. Access the Android TV homepage by pressing  on the remote control.

3. Select  (Settings) > Quick Settings > "Ok Google" detection and press OK to turn it on. You can also set it by selecting  (Settings) > Device Preferences > Google Assistant > "Ok Google" detection.
4. Say "OK Google" to activate it.

Other Information

Problems & Solutions

1. Fail to link to the network.
 - Check if your TV is connected with the network;
 - Reboot your TV;
 - Consult your internet service provider, to confirm if access of your router is supported. Refer to the operation manual of your router.
 - Make sure your TV is connected to a router, and make sure your router is powered on. Check that your router/modem has an internet connection, and that your Ethernet cables/wireless connection is OK. Test your connection with a computer to make sure it is OK. Should the problem persist, contact customer service.
2. The video could not be played smoothly.
 - Videos from your USB flash drive --- It may result from data transmission, or its code flow is far beyond the supported formats of this TV set.
 - Videos downloaded from internet, or online videos.
 - a. It may be caused by the lower bandwidth of your network. A high network speed is required to handle online videos.
 - b. Peak internet usage times may affect the bandwidth.
 - c. Check if any other computers on the same network are also operating, as they may be using up bandwidth. Especially if they are downloading or playing on-line videos.
 - d. The video may not be smooth itself, it is not the problem of your TV or network.
3. When two mobile hard disks are connected with the TV at the same time, they will not be recognized some times.

- All mobile hard disks consume a lot of power, which may result in power supply problems. We recommend inserting only one hard disk, or a low power consumption mobile hard disk.

4. The video from a mobile hard disk (USB) is playing with no sound.

- The audio format of the video in your mobile hard disk is not supported by the TV player.

5. Some videos fail to play.

- The formats of the videos may not be supported by the TV, especially videos shot by certain kinds of cameras, generally with their private protocol of formats, which are not compatible with your TV.

6. Video stops playing midway.

- Mistakes may occur when videos are copied or compressed, so they may automatically stop playing during playback.

7. What should I pay attention to, when I do SW updating?

- No power cuts when SW updating;
- Avoid any operations with your remote control when SW updating;
- Depending on your internet connection speed, the software updating process may take some time.

8. There are no distinct changes of TV interface after SW updating.

- Under certain conditions, SW updating may not only update or add new functions but also improve the performance of the TV set, without distinct changes to the user interface. Also, there may be no changes to the user interface at all.

9. What should I do when SW updating process stops due to a sudden power-off?

- If you do SW updating by USB, do not pluck the USB from your TV, and restart your TV to continue SW updating; If you do SW updating by Network, also restart your TV and check if it is well functioned.

10. With a USB device being inserted into the TV in advance, I am prompted that no USB devices are detected after I access Media, why?

- There may be something wrong with your mobile hard disk(s), damaged or with low voltage. You could increase power supply by inserting the two plugs on one end on the USB wire into TV's USB port simultaneously.

11. External device cannot be recognized.

- Some external devices (e.g. webcam, smart phone, tablet, game handle, and external wireless adapter) may not be compatible with the TV and cannot be supported for certain functions (nScreen, wireless display, gesture control, face recognition, if any). Please try a similar device. If it does not work, contact your local dealer.

12. Voice search does not work.

- Check if your remote control has been successfully paired with your TV.
- Check if the language setting is correct.
- Check if Google server is available and stable.

Troubleshooting

No picture, no sound

1. Check if the fuse or circuit breaker is working.
2. Plug another electrical device into the outlet to make sure it is working or turned on.
3. Power plug is in a bad contact with the outlet.
4. Check the signal source.

No colour

1. Change the colour system.
2. Adjust the saturation.
3. Try another channel. Black-white programme may be received.

Remote control does not work

1. Change the batteries.
2. Batteries are not installed correctly.
3. Main power is not connected.

No picture, normal sound

1. Adjust the brightness and contrast.
2. Broadcasting failure may happen.

Normal picture, no sound

1. Press the VOLUME UP button to increase volume.
2. Volume is set to mute, press the Mute button to restore sound. (Available for RC802N remote control only.)
3. Change the sound system.

4. Broadcasting failure may happen.

Unorderly ripples on the picture

It is usually caused by local interference, such as cars, daylight lamps and hair driers. Adjust the antenna to minimize the interference.

Snowy dots and interference

If the antenna is located in the fringe area of a television signal where the signal is weak, the picture may be marred by dots. When the signal is extremely weak, it may be necessary to install a special antenna to improve the reception

1. Adjust the position and orientation of the indoor/ outdoor antenna.
2. Check the connection of antenna.
3. Fine tune the channel.
4. Try another channel. Broadcasting failure may happen.

Ignition

Black spots or horizontal streaks appear, or the picture futters or drifts. This is usually caused by interference from car ignition system, neon lamps, electric drills, or other electrical appliance.

Ghost

Ghosts are caused by the television signal following two paths. One is the direct path, the other is reflected from tall buildings, hills, or other objects. Changing the direction or position of the antenna may improve the reception.

Radio frequency interference

This interference produces moving ripples or diagonal streaks, and in some case, loss of contrast in the picture. Find out and remove the radio interference source.

*To bring you better visual experience, please remove all labels, if any, from TV front panel and screen before use.

*Figures and illustrations in this User Manual are provided for reference only and may differ from actual product appearance. Product design and specifications may be changed without notice

Warning

This content is compiled from multiple sources and is provided for reference purposes only. It may not be complete or fully applicable to all situations. If you are unable to resolve your issue, please contact the product manufacturer or an authorized service provider for official support.

