

Operating Instructions

About the controls on the refrigerator.

The controls will look like one of the following:

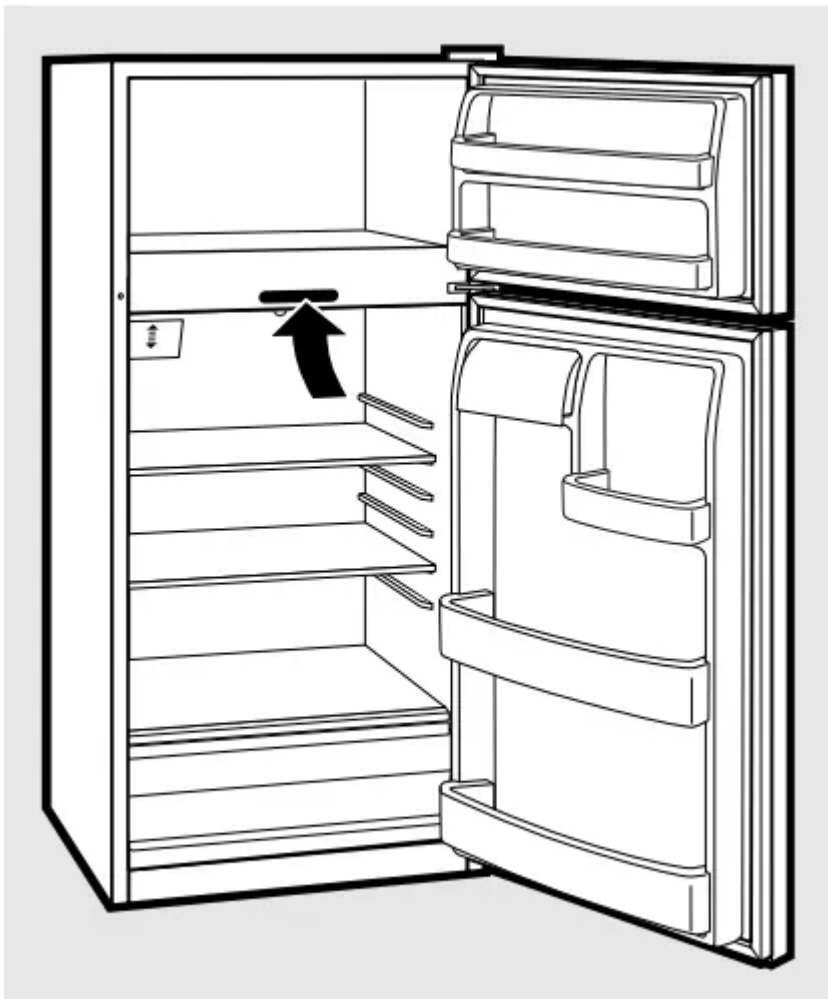
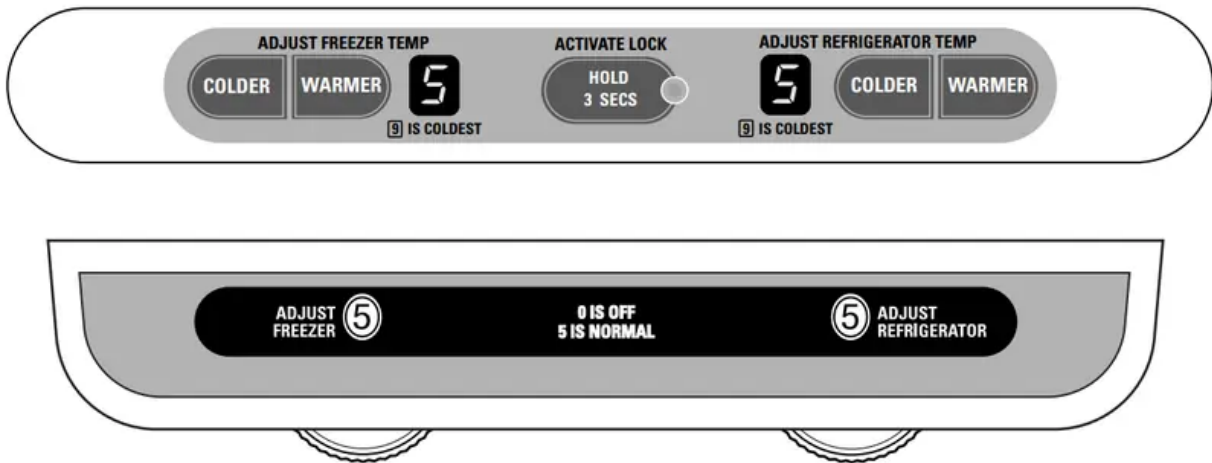

Initially, set the refrigerator control at 5 and the freezer control at 5 and allow 12–24 hours for the temperature to stabilize.

Several adjustments may be required. Adjust the controls one increment at a time, and allow 12 hours after each adjustment for the refrigerator to reach the temperature you have set.

Setting the controls to 0 stops cooling in both the refrigerator and freezer compartments but does not shut off electrical power to the refrigerator. On some models, only the refrigerator control has a 0 setting.

Touch pad controls

- Setting either control at 0 will automatically set the other control at 0. The zeros will blink until you set the controls.
- If both controls are set at 0 and either COLDER pad is pressed, the controls will automatically reset to 5.

Control settings will vary based on personal preferences, usage and operating conditions and may require more than one adjustment.

Locking the Controls (on some models)

This feature allows you to lock the controls so the settings cannot be changed.

To lock the controls:

1. Set the controls to the desired settings.
2. Press and hold the lock pad for 3 seconds.

When the controls are locked, the indicator light will come on and the control settings will not be displayed.

To unlock the controls:

Press and hold the lock pad for 3 seconds.

After unlocking the controls, the settings will be displayed, the lock indicator light will go out and the settings can be changed





The temperature controls are preset in the factory at **37°F** for the refrigerator compartment and **0°F** for the freezer compartment. Allow 24 hours for the temperature to stabilize to the preset recommended settings.

The temperature controls can display both the **SET** temperature as well as the actual temperature in the refrigerator and freezer. The actual temperature may vary slightly from the **SET** temperature based on usage and operating environment.

Setting either or both controls to **OFF** stops cooling in both the freezer and refrigerator compartments, but does not shut off electrical power to the refrigerator.

NOTE: The refrigerator is shipped with protective film covering the temperature controls. If this film was not removed during installation, remove it now.

To change the temperature, press and release the **WARMER** or **COLDER** pad. The **SET** light will come on and the display will show the set temperature.

To change the temperature, tap either the **WARMER** or **COLDER** pad until the desired temperature is displayed. Refrigerator temperatures can be adjusted between 34°F and 44°F and the freezer temperatures can be adjusted between -6°F and +6°F.

Once the desired temperature has been set, the temperature display will return to the actual refrigerator and freezer temperatures after 5 seconds. Several adjustments may be required. Each time you adjust controls, allow 24 hours for the refrigerator to reach the temperature you have set.

To turn the cooling system off, tap the **WARMER** pad

for either the refrigerator or the freezer until the display shows **OFF**. **To turn the unit back on**, press the **COLDER** pad for either the refrigerator or freezer. The **SET** light will illuminate on the side you selected. Then press the **COLDER** pad again (on the side where the **SET** light is illuminated) and it will go to the preset points of **0°F** for the freezer and **37°F** for the refrigerator. Setting either or both controls to **OFF** stops cooling in both the freezer and refrigerator compartments, but does not shut off electrical power to the refrigerator.

Locking the Controls (on some models)

This feature allows you to lock the controls so the settings cannot be changed.

To lock the controls:

1. Set the controls to the desired settings.
2. Press and hold the lock pad for 3 seconds.

When the controls are locked, the indicator light will come on and the control settings will not be displayed.

To unlock the controls:

Press and hold the lock pad for 3 seconds.

After unlocking the controls, the settings will be displayed, the lock indicator light will go out and the settings can be changed.

About the water filter. (on some models)

Water Filter Cartridge

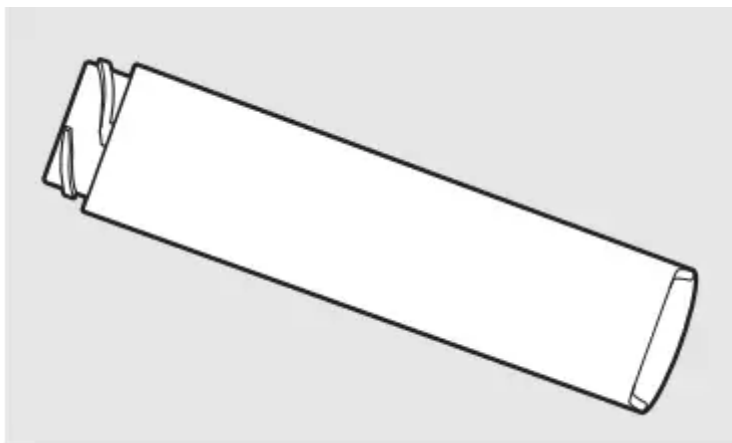

The water filter cartridge is located inside the cartridge holder in the back upper right corner of the refrigerator compartment.

NOTE: Some models ship with the filter bypass plug in place of the filter cartridge. The filter bypass plug needs to be removed before the filter cartridge is installed. Keep the filter bypass plug for future use.

When to Replace the Filter

The filter cartridge should be replaced every **six months** or earlier if the flow of water to the icemaker and dispenser decreases.

Installing the Filter Cartridge

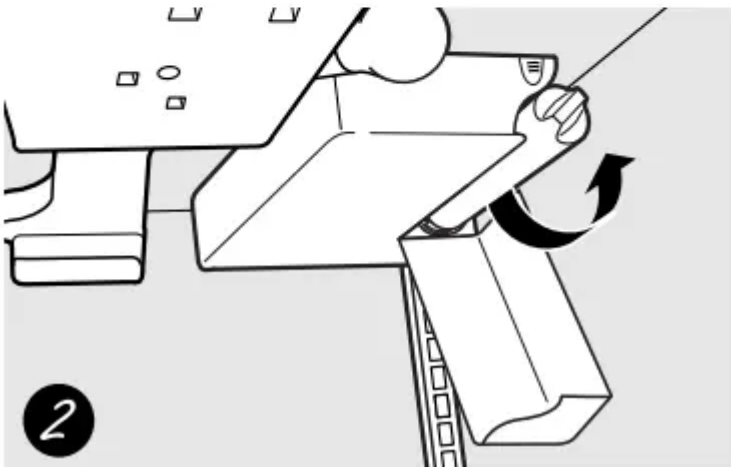
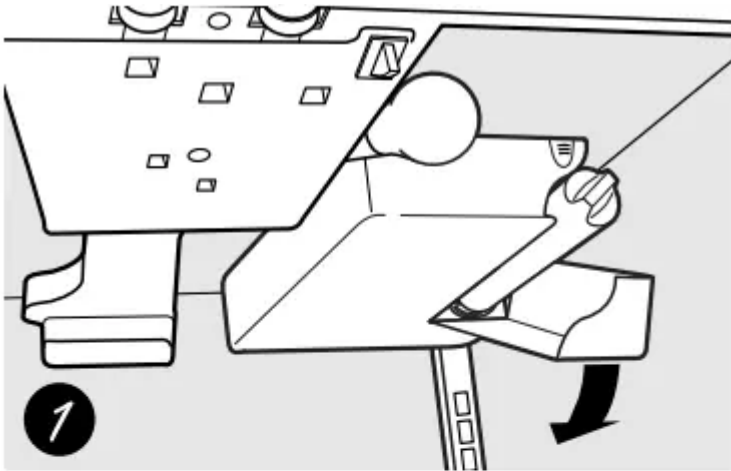

1. If you are replacing the cartridge, first remove the old one. To open the cartridge cover, push in where indicated and the cover will drop down.



2. Remove the cartridge by slowly rotating it to the left. A small amount of water may drip down.

- **CAUTION:** If air has been trapped in the system, the filter cartridge may be ejected as it is removed. Use caution when removing.

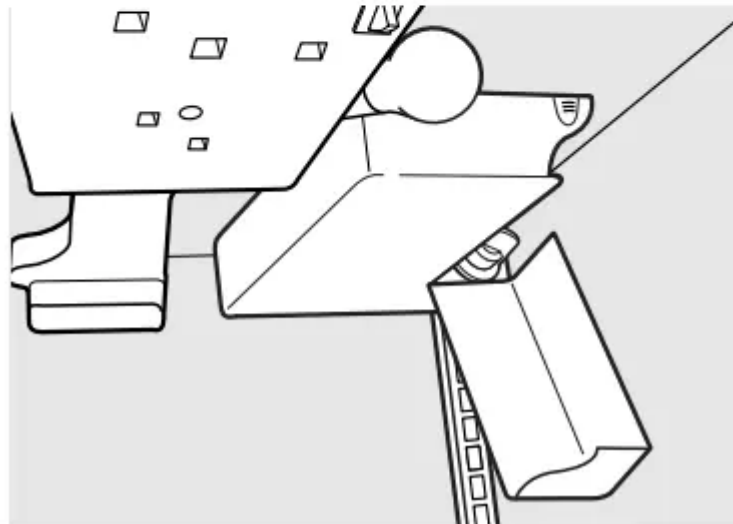
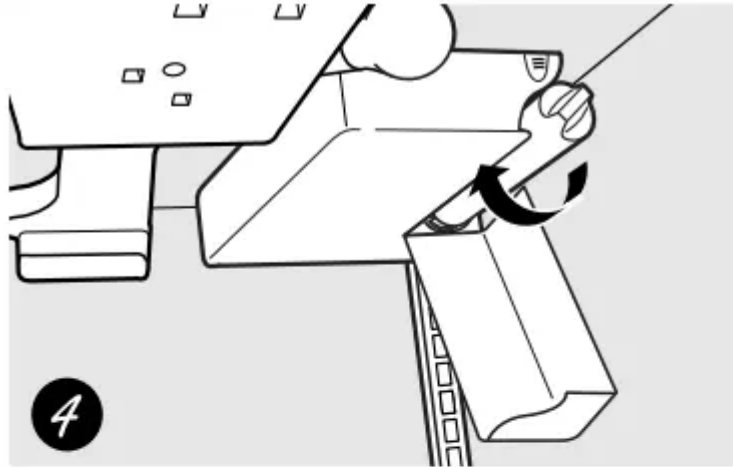

3. Mark your calendar to remind you to replace the filter cartridge in six months.

4. Remove the protective foil from the end of the cartridge.

5. Position the cartridge inside the cartridge holder and slowly rotate the cartridge to the right until it stops. When the cartridge is properly installed, you will feel it “click” as it locks into place. The blade on the end of the cartridge should be positioned vertically. Do not overtighten.

6. Close the cartridge cover.

7. Run water from the dispenser for 3 minutes (about 1/2 gallons) to clear the system and prevent sputtering. See To Use the Dispenser section.

NOTE: A newly-installed water filter cartridge may cause water to spurt from the dispenser.

Filter Bypass Plug

You must use the filter bypass plug when a replacement filter cartridge is not available. The dispenser and the icemaker will not operate without the filter or filter bypass plug.

About the shelves and bins.

Rearranging the Shelves

Shelves in the refrigerator and freezer compartments are adjustable.

Refrigerator Compartment

To remove:

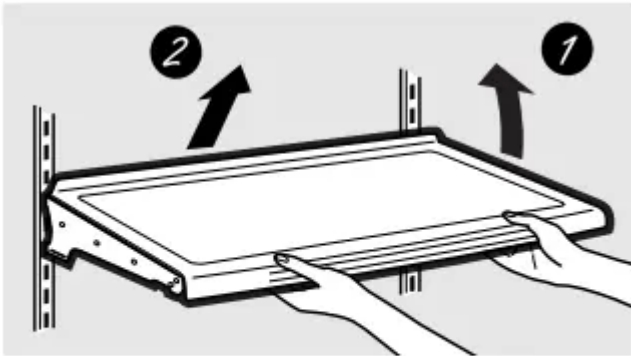

Some models have wire shelves that can be adjusted in the same manner.

1. Tilt the shelf up at the front.
2. Lift the shelf up at the back and bring the shelf out.

To replace:

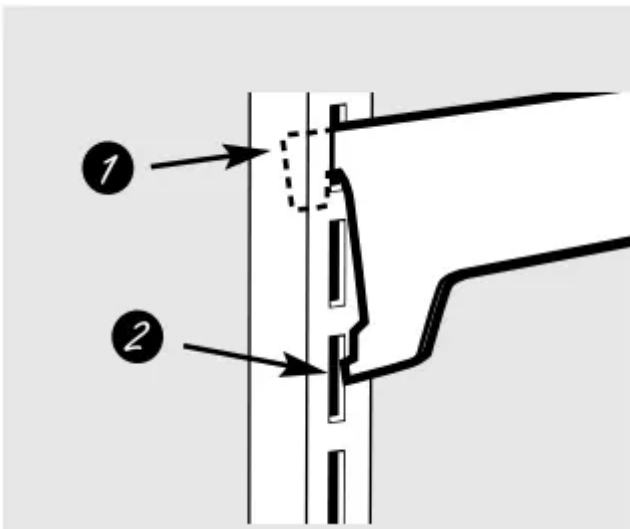

1. While tilting the shelf up, insert the top hook at the back of the shelf in a slot on the track.
2. Lower the front of the shelf until the bottom of the shelf locks into place.

Freezer Compartment

To remove:

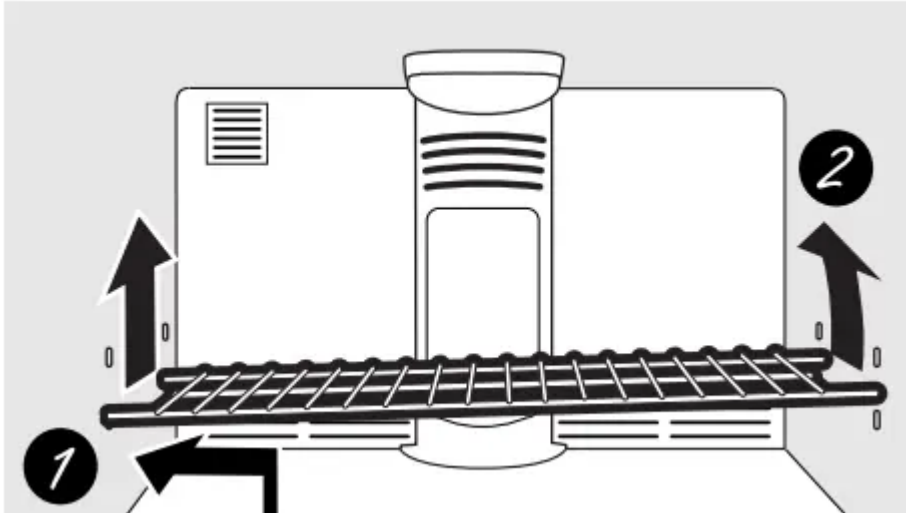

1. Lift up the left side of the shelf and slide it left into the center of the shelf supports.
2. Rotate the right side of the shelf up and out of the shelf supports.

To replace:

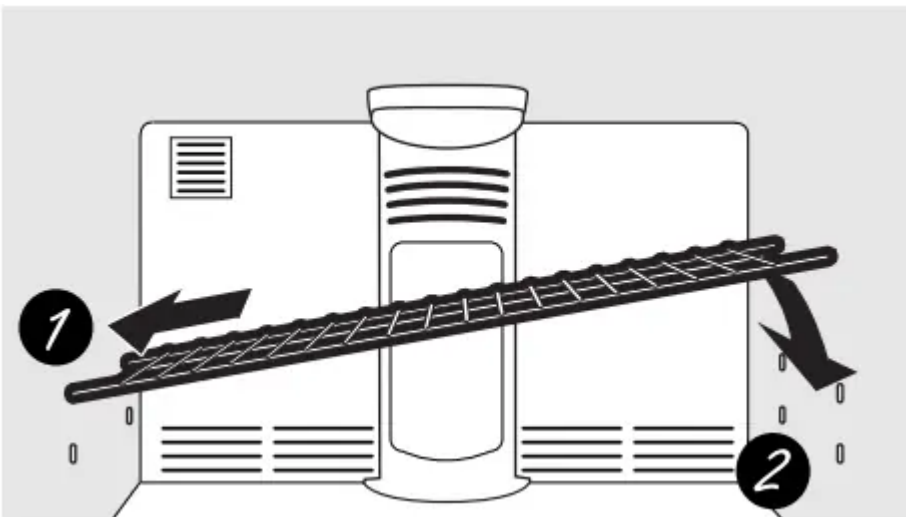

1. Holding the shelf diagonally, insert the left end of the shelf into the center of the shelf supports on the side wall at the desired level.
2. Insert the right end of the shelf into the shelf supports at the same level. Rest each end of the shelf on the bottom of the shelf supports.

NOTE: For models with an automatic icemaker, the freezer shelf must be in the lower position for the ice cube bucket to catch the cubes.

Spillproof Shelves (on some models)

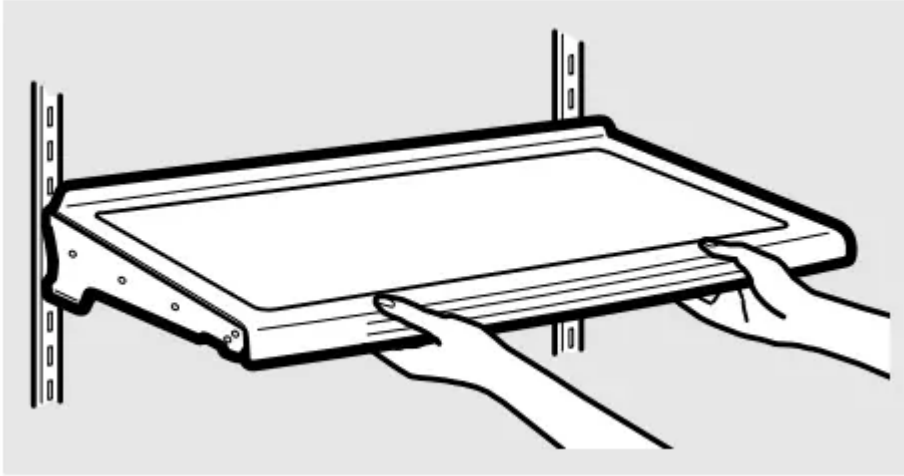

Spillproof shelves have special edges to help prevent spills from dripping to lower shelves. To remove or replace the shelves, see [Rearranging the Shelves](#).

Slide-Out Spillproof Shelf (on some models)

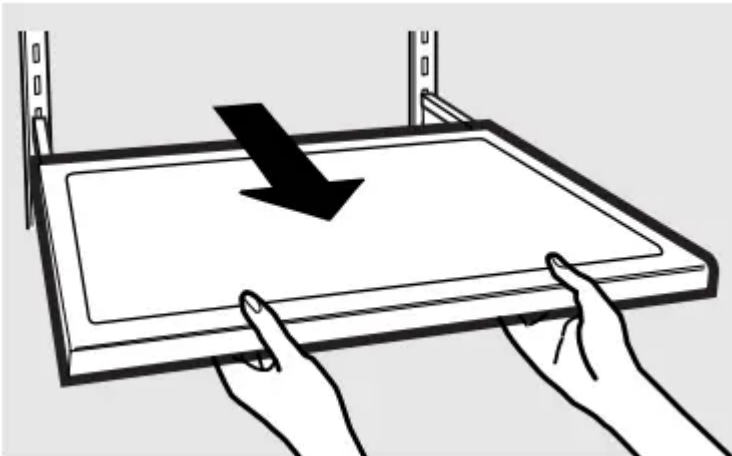

The slide-out spillproof shelf allows you to reach items stored behind others. The special edges are designed to help prevent spills from dripping to lower shelves.

To remove:

1. Remove all items from shelf.
2. Slide the shelf out until it stops.
3. Lift the front edge of the shelf until the central tabs are above the front bar.
4. Continue pulling the shelf forward until it can be removed.

To replace:

1. Place the rear shelf tabs just in front of the central notches on the shelf frame.
2. Slide the shelf in until the central tabs are slightly behind the front bar.
3. Lower the shelf into place until it is horizontal and slide the shelf in.

Make sure that the shelf sits flat after reinstallation and doesn't move freely from side to side.

Make sure you push the shelves all the way in before you close the door

Adjustable Bins on the Door

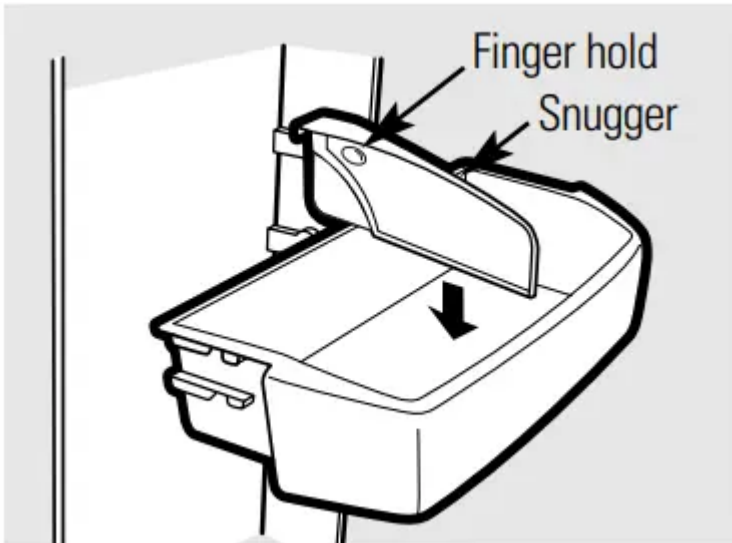

Adjustable bins can easily be carried from refrigerator to work area.

To remove: Lift bin straight up, then pull out.

To replace or relocate: Engage the bin in the molded supports of the door, and push in. Bin will lock in place.

The snugger helps prevent tipping, spilling or sliding of small items stored on the door shelf. Grip the finger hold near the rear of the snugger and move it to fit your needs.

Non-Adjustable Shelves on the Door

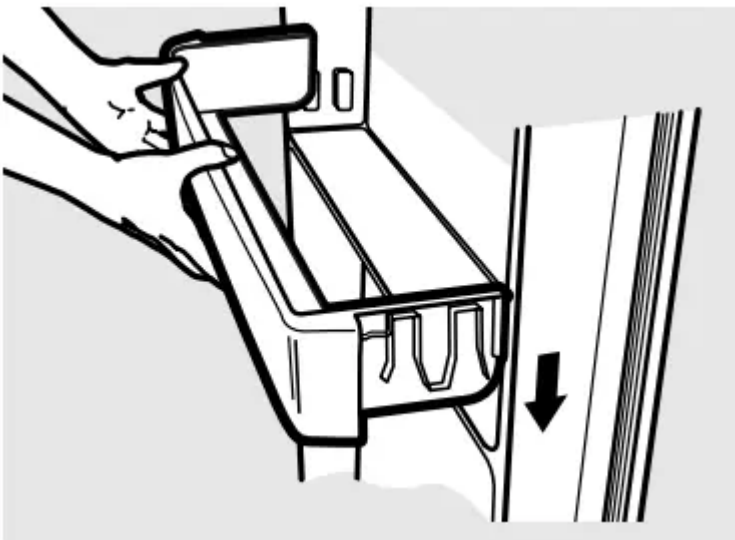

To remove: Lift the shelf straight up, then pull out.

To replace: Engage the shelf in the molded supports on the door and push down.

It will lock in place.

Freezer Tilt Out Bin (on some models)

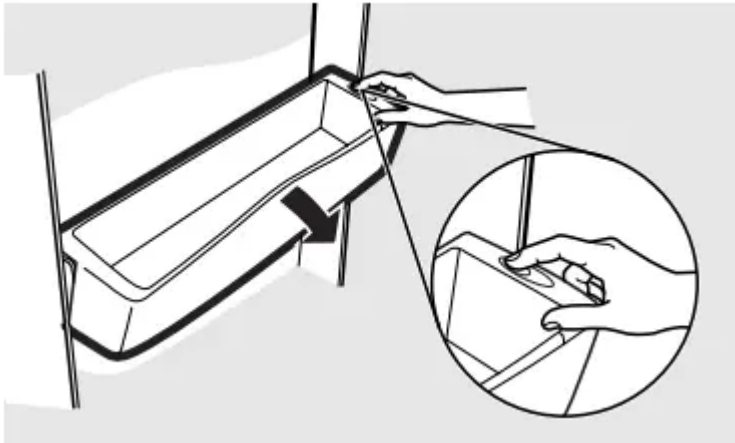

Push the button as you tilt out the bin.

To remove: Hold the sides of the bin and lift it straight up, then pull out.

To replace: Engage the ends of the bin in the molded supports on the door and push down. It will lock in place.

NOTE: Do not overload the bin.

About the additional features.

Not all features are on all models.

Shelf Saver Rack (on some models)

Slide-out beverage rack holds 12 cans of soda or 2 wine/water bottles (lengthwise). It can be removed for cleaning.

To remove, slide the rack out to the **stop** position, lift the rack up and past the **stop** position and lift it out.

About the crispers and pans

Fruit and Vegetable Crisper

Excess water that may accumulate in the bottom of the drawers or under the drawers should be wiped dry.

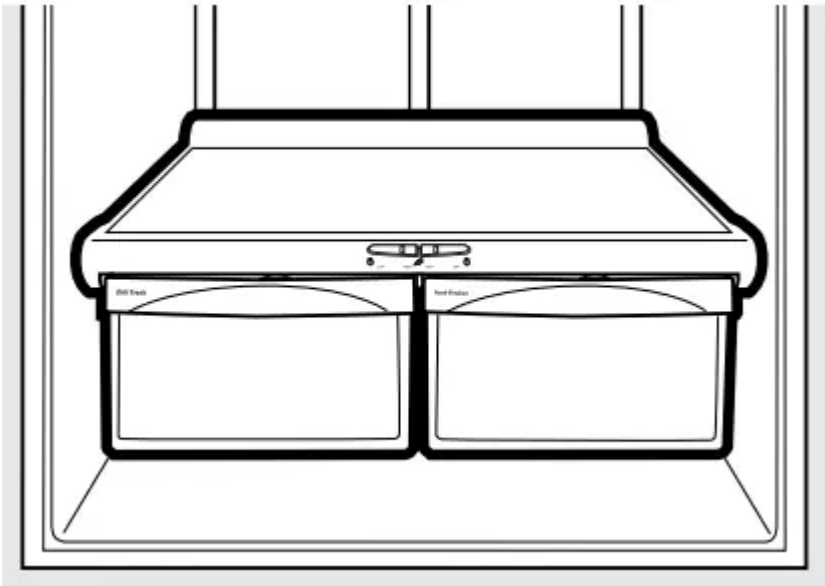

Adjustable Humidity Crisper (on some models)

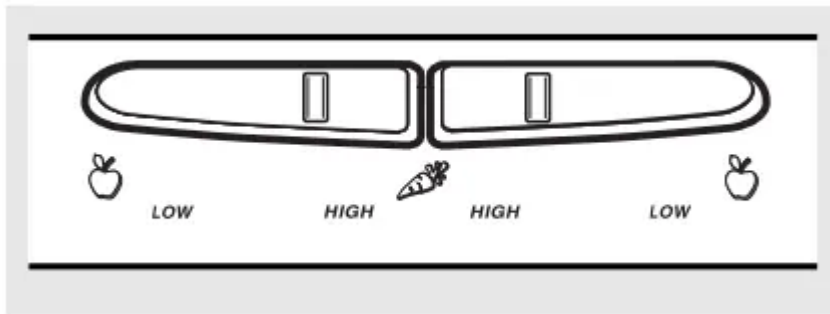

Slide the control all the way to the HIGH setting to provide high humidity recommended for most vegetables.

Slide the control all the way to the LOW setting to provide lower humidity levels recommended for most fruits.

Snack Pan (on some models)

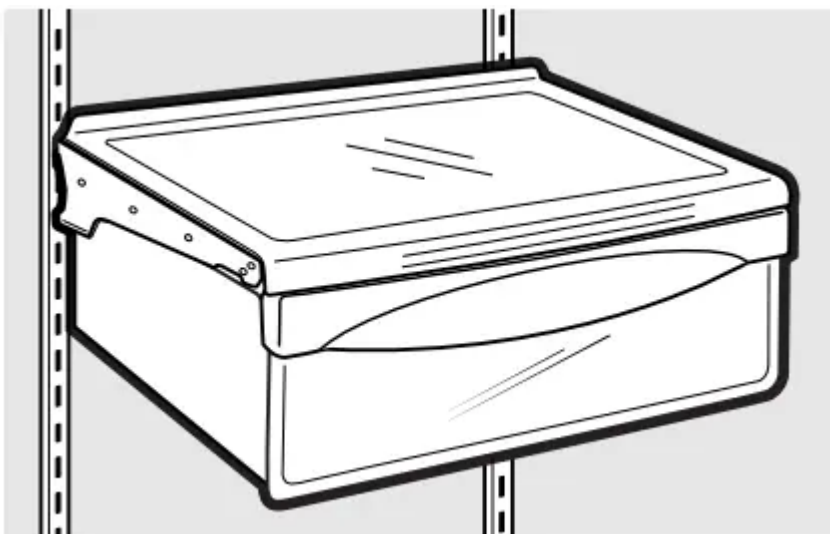

This pan can be moved to the most useful location for your family's needs.

To remove, slide the pan out to the **stop** position, lift the pan up and past the **stop** position and lift it out.

Adjustable Temperature Deli Pan (on some models)

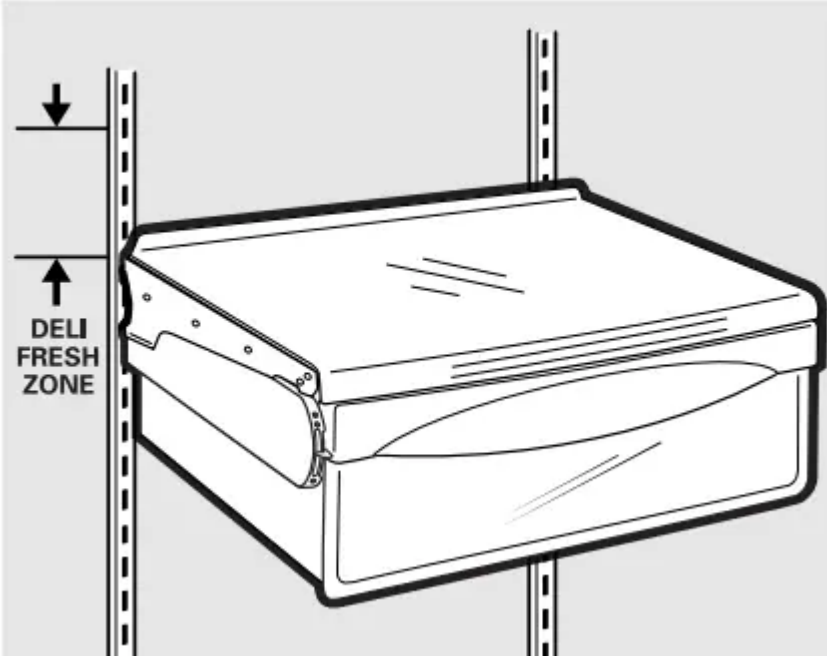

When the pan is placed in the top 6 slots on the left side and the lever is set at **COLDEST**, air from the freezer is forced around the pan to keep it very cold.

You can move the pan to any location if you don't want the extra cold storage.

The settings can be adjusted anywhere between cold ❄️ and coldest ❄️❄️.

When set at cold, the pan will stay at the normal refrigerator temperature.

The coldest setting provides the coldest storage area.

Crisper Removal

To Remove:

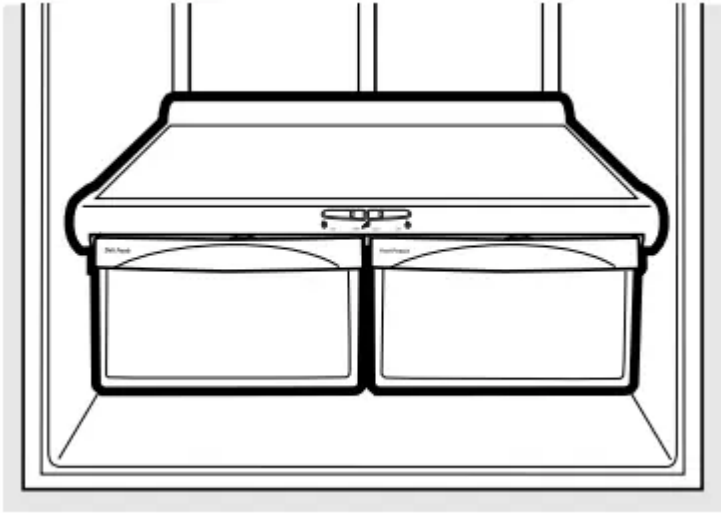

These drawers can be removed easily by lifting up slightly while pulling the drawer past the **stop** location.

When the door cannot be fully opened,

remove the drawer farthest from the door first. Make sure the drawer closest to the door is fully closed. There is a latch at the front of the center slide rail. Push down on the latch and slide the center slide rail, to which the drawer is attached, away from the door. Remove the drawer.

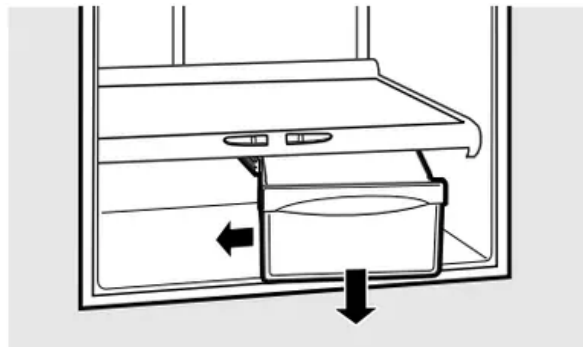
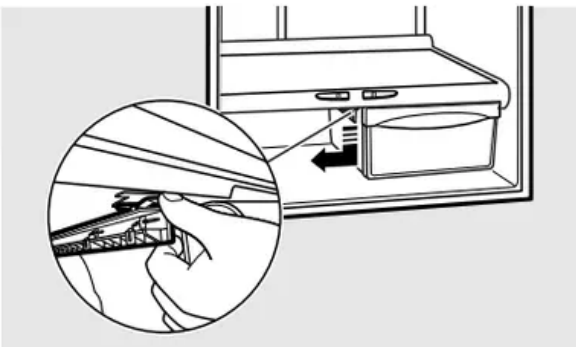

About the automatic icemaker

A newly-installed refrigerator may take 12–24 hours to begin making ice.

Automatic Icemaker (on some models)



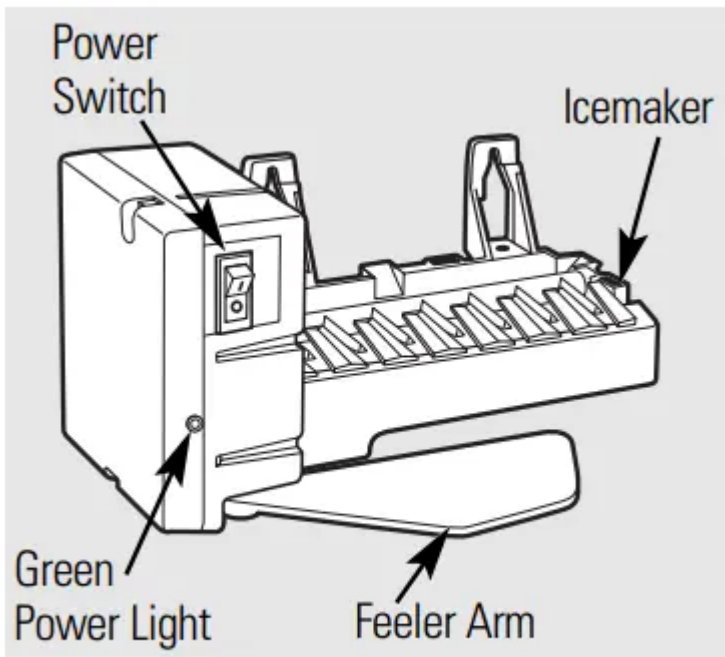

Power switch model

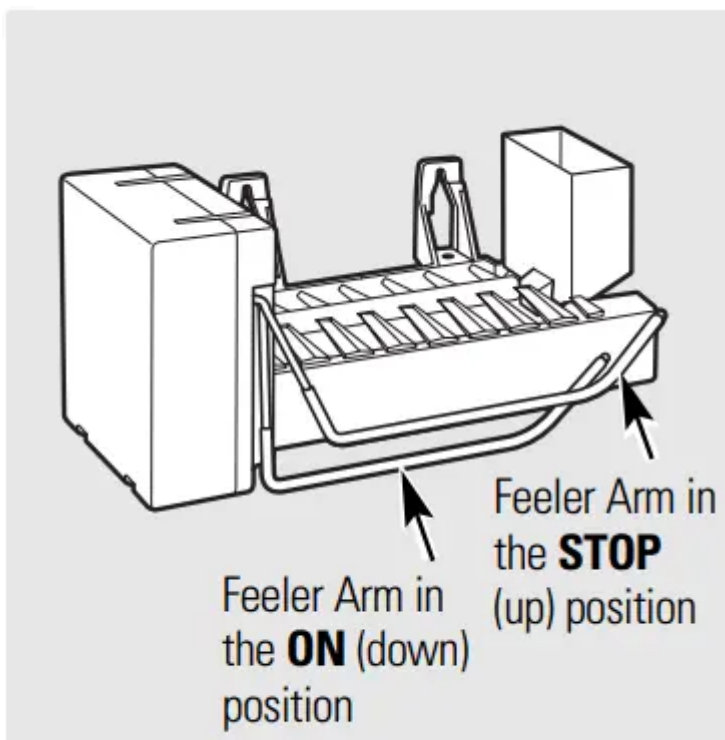

Feeler arm model

The icemaker will produce seven or eight cubes (depending on model) per cycle— approximately 100-130 cubes in a 24-hour period, depending on freezer compartment temperature, room temperature, number of door openings and other use conditions.

There are two types of icemakers: power switch models and feeler arm models.

If the refrigerator is operated before the water connection is made to the icemaker, set the power switch to **O (off)** or move the feeler arm to the **STOP** (up) position.

When the refrigerator has been connected to the water supply, set the power switch to the **I (on)** position or move the feeler arm to the **ON** (down) position. On power switch models, the green light will come on.

You will hear a buzzing sound each time the icemaker fills with water.

The icemaker will fill with water when it cools to approximately 15°F. A newly-installed refrigerator may take 12 to 24 hours to begin making ice cubes.

Throw away the first few batches of ice to allow the water line to clear.

Be sure nothing interferes with the sweep of the feeler arm.

When the bin fills to the level of the feeler arm, the icemaker will stop producing ice.

It is normal for several cubes to be joined together.

If ice is not used frequently, old ice cubes will become cloudy, taste stale and shrink.

On power switch models, the green power light will blink if ice cubes get stuck in the icemaker. To correct this, set the power switch to **O (off)** and remove the cubes. Set the power switch to **I (on)** to restart the icemaker. After the icemaker has been turned on again, there will be a delay of about 45 minutes before the icemaker resumes operation.

NOTE: In homes with lower-than-average water pressure, you may hear the icemaker cycle multiple times when making one batch of ice.

Icemaker Accessory Kit

If your refrigerator did not come already equipped with an automatic icemaker, an icemaker accessory kit is available at extra cost.

Check the back of the refrigerator for the specific icemaker kit needed for your model.

About the water dispenser. (on some models)

The water dispenser is located on the left wall inside the refrigerator compartment.

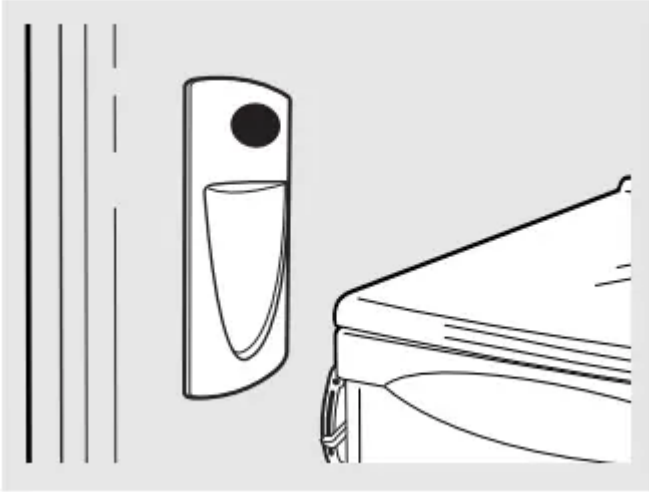

To dispense water:

1. Hold the glass against the recess.
2. Push the water dispenser button.
3. Hold the glass underneath the dispenser for 2-3 seconds after releasing the dispenser button. Water may continue to dispense after the button is released.

If no water is dispensed when the refrigerator is first installed, there may be air in the water line system. Press the dispenser button for at least 2 minutes to remove trapped air from the water line and to fill the water system. During this process, the dispenser noise may be loud as the air is purged from the water line system. To flush out impurities in the water line, throw away the first 6 glassfuls of water.

NOTE: To avoid water deposits, the dispenser should be cleaned periodically by wiping with a clean cloth or sponge.

Care and cleaning

Cleaning the Outside

The door handles and trim. Clean with a cloth dampened with soapy water.

Dry with a soft cloth.

Keep the outside clean. Wipe with a clean cloth lightly dampened with mild liquid dish detergent.

Dry with a clean, soft cloth.

Do not wipe the refrigerator with a soiled dish cloth or wet towel. These may leave a residue that can erode the paint. Do not use scouring pads, powdered cleaners, bleach or cleaners containing bleach because these products can scratch and weaken the paint finish.

Cleaning the Inside

To help prevent odors, leave an open box of baking soda in the refrigerator and freezer compartments.

Unplug the refrigerator before cleaning.

If this is not practical, wring excess moisture out of sponge or cloth when cleaning around switches, lights or controls.

Use warm water and baking soda solution— about a tablespoon (15 ml) of baking soda to a quart (1 liter) of water. This both cleans and neutralizes odors. Thoroughly rinse and wipe dry.

Avoid cleaning cold glass shelves (on some models) with hot water because the extreme temperature difference may cause them to break. Handle glass shelves carefully. Bumping tempered glass can cause it to shatter.

Do not wash any refrigerator parts in the dishwasher.

Wash ice trays in lukewarm water only—do not put them in an automatic dishwasher.

Behind the Refrigerator

Be careful when moving the refrigerator away from the wall. All types of floor coverings can be damaged, particularly cushioned coverings and those with embossed surfaces.

Pull the refrigerator straight out and return it to position by pushing it straight in.

Moving the refrigerator in a side direction may result in damage to the floor covering or refrigerator.

When pushing the refrigerator back, make sure you don't roll over the power cord or icemaker supply line (on some models).

Preparing for Vacation

For long vacations or absences, remove food and unplug the refrigerator. Move the freezer control to the **0 (off)** position, and clean the interior with a baking soda solution of one tablespoon (15 ml) of baking soda to one quart (1 liter) of water. Leave the doors open.

Set the icemaker power switch to the **O (off)** position and shut off the water supply to the refrigerator.

If the temperature can drop below freezing, have a qualified servicer drain the water supply system (on some models) to prevent serious property damage due to flooding.

Preparing to Move

Secure all loose items such as base grille, shelves and drawers by taping them securely in place to prevent damage.

Be sure the refrigerator stays in an upright position during moving.

Replacing the light bulbs.

Turning the control to the 0 (off) position does not remove power to the light circuit.

Refrigerator Compartment

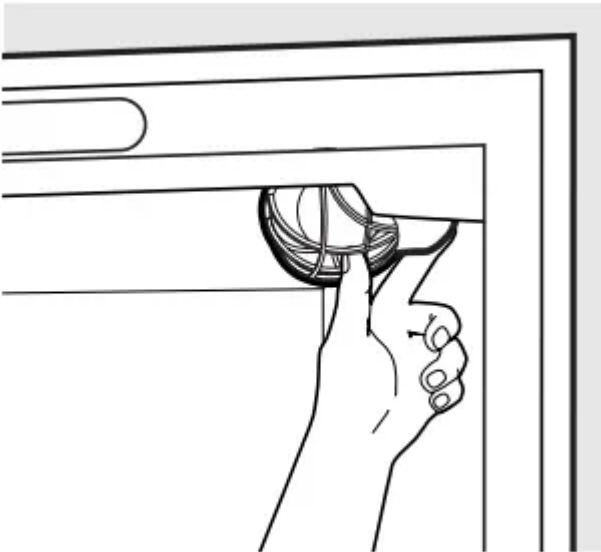

CAUTION: Light bulbs may be hot.

1. Unplug the refrigerator.
2. The bulbs are located at the top of the refrigerator compartment near the opening. On some models, a light shield will have to be removed.
3. To remove the light shield, grasp the shield as shown. Squeeze the shield and rotate the shield toward the back of the refrigerator. The light shield will pop out.
4. Replace the bulb with an appliance bulb of the same or lower wattage. On models with a light shield, replace the light shield.
5. Plug the refrigerator back in.

Freezer Compartment Light (on some models)

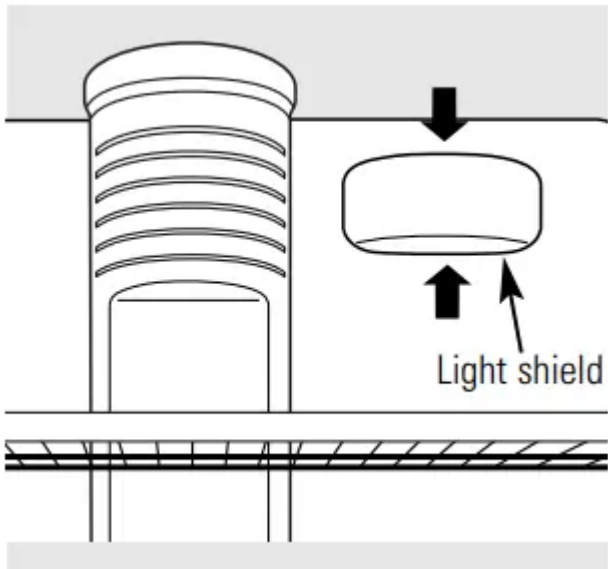

CAUTION: Light bulbs may be hot.

1. Unplug the refrigerator.
2. The bulb is located behind a light shield at the back of the freezer compartment. To remove, squeeze the top and bottom of the shield and pull the shield off.
3. After replacing with an appliance bulb of the same or lower wattage, replace the shield.
4. Plug the refrigerator back in.

Freezer Compartment Dome Light (on some models)

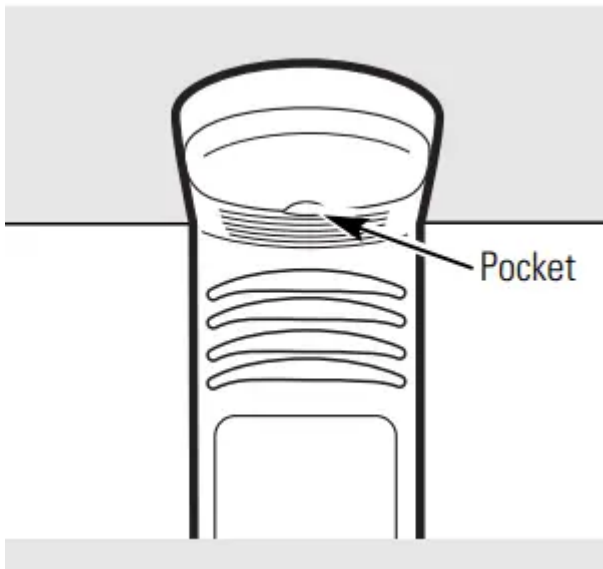

CAUTION: Light bulbs may be hot.

1. Unplug the refrigerator.
2. The bulb is located at the top of the freezer compartment inside the dome light shield. To remove the shield, place your finger in the pocket at the back of the shield. Pull the shield forward and down.

3. After replacing with an appliance bulb of the same or lower wattage, replace the shield.
4. Plug the refrigerator back in.

Troubleshooting Tips

Normal operating sounds.

Do you hear what I hear? These sounds are normal

HUMMM...
WHOOSH...

- The new high efficiency compressor may run faster and longer than your old refrigerator and you may hear a high-pitched hum or pulsating sound while it is operating.
- You may hear a whooshing sound when the doors close. This is due to pressure equalizing within the refrigerator.

Electronic models only:

- Sometimes the refrigerator runs for an extended period, especially when the doors are opened frequently. This means that the Frost Guard™ feature is working to prevent freezer burn and improve food preservation.

WHIR!



- You may hear the fans spinning. The fans help to maintain the correct temperatures.

Electronic models only:

- You may hear the fans spinning at high speeds. This happens when the refrigerator is first plugged in, when the doors are opened frequently or when a large amount of food is added to the refrigerator or freezer compartments.
- If either door is open for over 3 minutes, you may hear the fans come on in order to cool the light bulbs.
- The fans change speeds in order to provide optimal cooling and energy savings.

CLICKS, POPS, CRACKS and CHIRPS

- You may hear cracking or popping sounds when the refrigerator is first plugged in. This happens as the refrigerator cools to the correct temperature.
- The compressor may cause a clicking or chirping sound when attempting to restart (this could take up to 5 minutes).
- The electronic control board may cause a clicking sound when relays activate to control refrigerator components.
- Expansion and contraction of cooling coils during and after defrost can cause a cracking or popping sound.
- On models with an icemaker, after an icemaking cycle, you may hear the ice cubes dropping into the ice bucket.
- On models with a dispenser, during water dispense, you may hear the water lines move at initial dispense and after dispenser button is released.

WATER SOUNDS



- The flow of refrigerant through the freezer cooling coils may make a gurgling noise like boiling water.
- Water dropping on the defrost heater can cause a sizzling, popping or buzzing sound during the defrost cycle.
- A water dripping noise may occur during the defrost cycle as ice melts from the evaporator and flows into the drain pan.
- Closing the door may cause a gurgling sound due to pressure equalization.

Before you call for service...



Problem	Possible Causes
Refrigerator does not operate	Refrigerator in defrost cycle.
	The controls are set to the 0 (off) position.
	Refrigerator is unplugged.
	The fuse is blown/circuit breaker is tripped.
Vibration or rattling (slight vibration is normal)	Rollers need adjusting.
Motor operates for long periods or cycles on and off frequently. (Modern refrigerators with more storage space and a larger freezer require more operating time. They start and stop often to maintain even temperatures.)	Normal when refrigerator is first plugged in.
	Often occurs when large amounts of food are placed in refrigerator.
	Door left open.
	Hot weather or frequent door openings.
	Temperature controls set at the coldest setting.
Refrigerator or freezer compartment too warm	Temperature control not set cold enough.
	Warm weather or frequent door openings.
	Door left open.



Problem	Possible Causes
Refrigerator does not operate	Refrigerator in defrost cycle.
Frost or ice crystals on frozen food (frost within package is normal)	Door left open. Too frequent or too long door openings.
Automatic icemaker (on some models) does not work	Icemaker power switch is in the O (off) position. Water supply turned off or not connected. Freezer compartment too warm. Piled up cubes in the storage bin cause the icemaker to shut off. Ice cubes stuck in icemaker. (Green power light on icemaker blinking.)
Frequent “buzzing” sound	Icemaker power switch is in the I (on) position, but the water supply to the refrigerator has not been connected.



	Refrigerator control is set too cold.
Door does not close by itself	Rollers need adjusting.
Orange glow in the freezer	Defrost heater is on.



Actual temperature not equal to Set temperature (on some models)	Unit just plugged in. Door open for too long. Warm food added to refrigerator.
	Defrost cycle is in process.

Warning

This content is compiled from multiple sources and is provided for reference purposes only. It may not be complete or fully applicable to all situations. If you are unable to resolve your issue, please contact the product manufacturer or an authorized service provider for official support.

