

Guide to the dishwasher

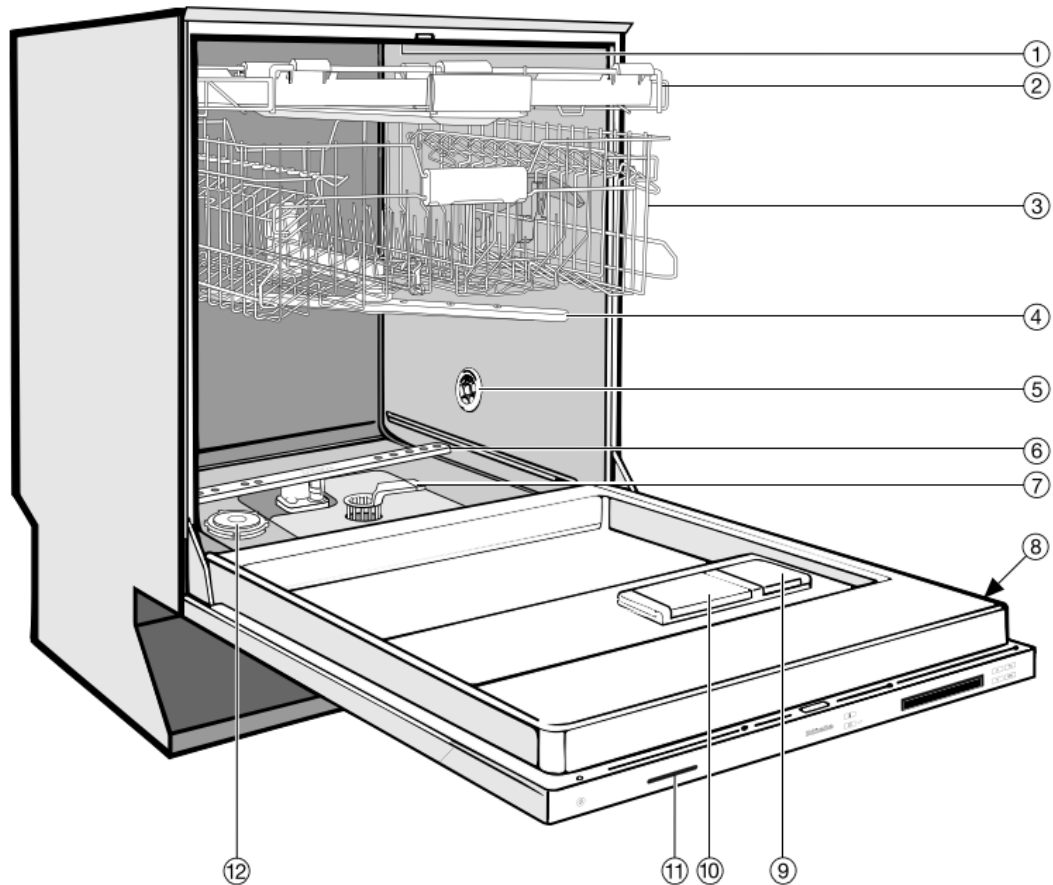

Appliance overview

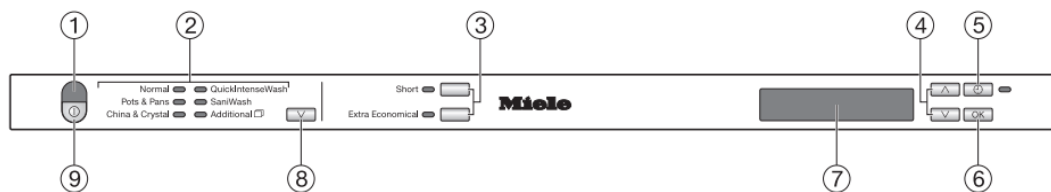

1. Upper spray arm (not visible)
2. Cutlery tray (depending on model)
3. Upper basket
4. Middle spray arm
5. Heat exchanger return (depending on model)
6. Lower spray arm
7. Filter combination
8. Data plate
9. Rinse aid reservoir
10. Double-chamber detergent dispenser
11. In-operation indicator light
12. Reservoir for reactivation salt

Control panel



1. In-operation indicator light
2. Program selection
3. Short and Extra Economical option buttons with indicator lights
4. Arrow buttons $\vee \wedge$
5.  button (FlexiTimer) with indicator light
6. OK button
7. Display
8. Program selection button \vee
9.  (On/Off) button

Display functions

General information

The display is used to select or set the following:

- The program
- The FlexiTimer (Delay Start)
- The Settings menu

The display can show the following:

- The program stage
- The estimated time left for the program to run
- Any relevant fault messages and information

To save energy, the dishwasher switches off after a few minutes if you do not press any buttons during this time.

To switch the dishwasher back on again, press the  button.

Settings menu

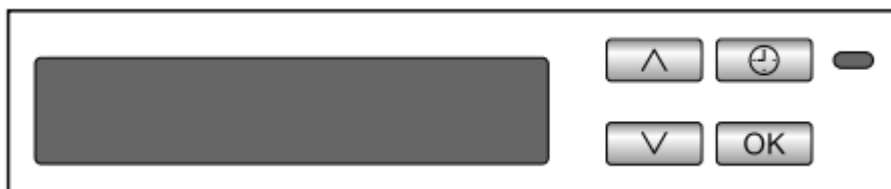

The Settings menu is used to adapt the electronic module of the dishwasher to changing requirements. See the “Settings menu” chapter for more information on accessing the settings menu.

The arrows in the display indicate additional options. You can use the ∨ ∧ arrow buttons next to the display, as appropriate, to select these additional options.

The OK button is used to confirm a message or setting and also to move to the next menu or another level.

The option which is selected will have a check mark next to it.

To exit a sub-menu, use the ∨ ∧ arrow buttons to select the *Back*  option in the display and confirm your choice with OK.

If you do not press any of the buttons for several seconds, the display will return to the previous level. You may need to enter your settings again.

Operation

Detergent

Active ingredients

Modern detergents contain various active ingredients, the most important of which are:

- Complexing agents to prevent calcification.
- Alkalis to aid the removal of dried-on soiling.
- Enzymes to break down starch and loosen protein.
- Oxygen-based bleaching agents to remove colored stains (e.g., tea, coffee, tomato sauce).

Most dishwasher detergents are mildly alkaline and contain enzymes and oxygen-based bleaching agents. There are different types of detergent:

- Powder and liquid gel detergents. These detergents allow you to adjust the amount dispensed according to the amount of load and level of soiling.
- Tab detergents. These are suitable for most levels of soiling.

You can also buy Tab products (see “Options, DetergentAgent”, if applicable).

In addition to detergent, these products contain rinse aid and salt substitutes. They are available as “3 in 1” or when they also contain other components such as glass and stainless steel protective additives and enhanced cleaning power, as “5 in 1”, “7 in 1”, “All in 1” etc.

Refer to the manufacturer’s packaging as to whether Tab products are suitable for the water hardness level in your area. Please note that the cleaning and drying results of Tab detergents can vary greatly

Detergent dosage

- Follow the dosage recommended by the manufacturer on the packaging.
- Unless directed otherwise, use one detergent tab or add 1 1/4 - 2 tablespoons (20 - 30 ml) detergent to compartment II, depending on the level of soiling. With very heavy soiling you can also add a small amount of detergent to compartment I.
- Tabs may not dissolve completely when the “QuickIntenseWash” program (if available) is used.

Use only the recommended amount of detergent. Continued use of too much detergent may cause machine damage.

Warning! Dishwasher detergents can cause burning in the nose, mouth, and throat if swallowed, or inhibit breathing. Avoid inhaling or swallowing dishwasher detergent. Keep children away from detergent. Keep detergent out of the reach of children. Keep children away from the dishwasher when the door is open. There could still be detergent residues in the dishwasher. Only add detergent just before starting the program and lock the door with the child lock (depending on model).

Adding detergent

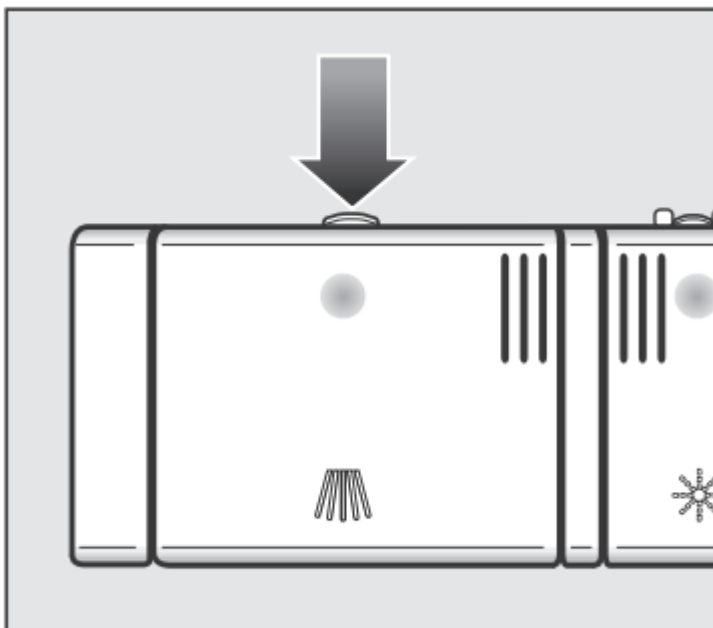

- Press the opening catch on the detergent dispenser. The flap will spring open.

The flap is always open at the end of a program.

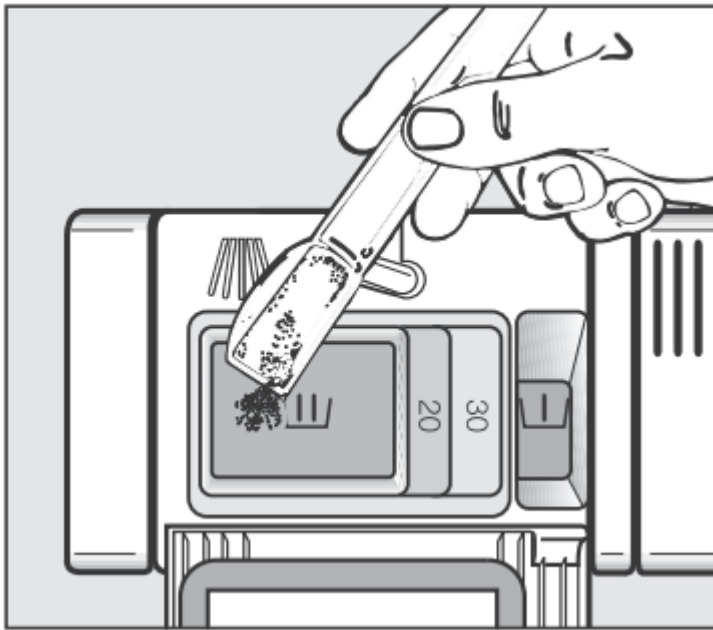

- Add the required amount of detergent and close the flap.
- Make sure that the detergent packaging is properly closed after use to avoid it getting damp and becoming lumpy.

Dispensing aid

Compartment I holds a maximum of 2 teaspoons (10 ml), Compartment II holds a maximum of 3 ½ tablespoons (50 ml) of detergent.

The marks in compartment II indicate the levels of approximately 1 ¼ and 2 tablespoons (20 and 30 ml) respectively. The marks indicate the approximate fill level in ml when the door is open in a horizontal position.

Turning on

- Turn on the water supply if it is turned off.
- Open the door.
- Make sure the spray arms are not obstructed.
- Press the  button for at least 2 seconds.

The program selected will appear briefly in the display and the appropriate indicator light will come on. Then, the display will show the estimated program duration for the program selected.

Selecting a program

Choose your program according to the type of load and the degree of soiling. The different programs and their uses are described in the Program Overview chapter.



- Use the program selection button  to select the program required.

The indicator light of the selected program will come on.

Additional programs can be selected using the *Additional*  option.

- Use the program selection button  to select the *Additional*  option.

The first of the additional programs will appear in the display.

- Use the   arrow buttons to select the program required.

During the course of the program, you can use OK to display the name of the program which is currently running.

You can now select program options (see “Options”). If any program options are selected, the appropriate indicator lights will also light up.

Starting a program

- Start the program by closing the door within four seconds of the last press of a button.

The program will begin. The Optical Interface comes on to show that a program has been started.

If you do not close the door within four seconds, the indicator light of the selected program will flash and the message *Press OK to start* will appear in the display. The program cannot be started until you press the OK button and close the door within four seconds.

A program should only be canceled in the first few minutes, if at all. Otherwise important program stages could be omitted.

Time display

The estimated duration of the program selected appears in hours and minutes in the display before the program begins. During the program, the time left until the end of the program can only be viewed with the door open.

Each program phase is indicated by a symbol:

	Pre-wash / Soak
	Wash
	Interim rinse
	Rinse cycle
	Drying
	Finish

The program duration displayed may vary with the same program. It is influenced by, among other things, the water temperature at each intake, the reactivation process, the softener assembly, the type of detergent, the amount of dishes, and the amount of soiling.

When a program is selected for the first time, the display will show the average program duration for a cold water intake.

The times shown in the program overview refer to standard test loads and temperatures.

Each time a program is run, the electronic module calculates the program duration required depending on the temperature of the water taken into the dishwasher and the amount of dishes.

Energy management

To save energy, the dishwasher will switch off automatically 10 minutes after the last time a button has been pressed or after the end of the program (see “Settings menu - Optimize standby”).

- Press the  button to switch the dishwasher back on.

The dishwasher will not switch off while a program or the FlexiTimer is running or if there is a fault.

At the end of the program

At the end of a program, the In-operation indicator light will be visible flashing slowly with the door shut. The buzzer might also be sounding.

The program has finished when  *End* appears in the display and the door has opened slightly (if applicable).

In the *QuickIntenseWash* program, the door will not open until a few minutes after the program has finished.

The drying fan may continue to run for a few minutes at the end of the program.

- Open the door fully so that the door locking pins retract again.

You can now empty the dishwasher.

The In-operation indicator light will go out 10 minutes after the end of the program if the door is closed.

Warning! If you have deactivated the automatic door opening function (see “Settings menu, AutoOpen”), but would still like to open the door at the end of the program, make sure that you open the door fully. Otherwise steam from the dishwasher could damage the edge of the counter because the fan is no longer running.

Turning off the dishwasher

Turning off the dishwasher At the end of a program:

- Open the door.
- The dishwasher can be switched off at any time using the  button.

Switching the dishwasher off during a program stops the program. Turning the dishwasher off during the run-up to a delay start time (FlexiTimer) will also stop the process.

If the dishwasher is not going to be used for a longer period of time, e.g., while on vacation, the water supply should be turned off.

Unloading the dishwasher

Dishes tend to break and chip more easily when they are hot. Allow the dishes to cool until they are comfortable enough to handle before unloading them.

The dishes will cool much faster if you open the door when the program has ended.

First unload the lower basket, then the upper basket, and finally the cutlery tray (depending on model). This will prevent water drops from the upper basket and cutlery tray from falling onto the dishes in the lower basket.

Interrupting a program

The program will be interrupted as soon as you open the door. After four seconds, the indicator light of the selected program will flash and the message Continue with OK will appear in the display.

- Press the OK and close the door within four seconds.



The program will continue from the point at which it was interrupted.

Warning! Water in the dishwasher may be hot. Danger of scalding! Only open the door if absolutely necessary and exercise extreme caution when doing so. Before closing the door again, leave it ajar for approx. 20 seconds. This will enable the temperature in the wash cabinet to settle. After that, press the OK and close the door within four seconds.

Changing a program

If the detergent dispenser flap has already opened, do not change the program.

If a program has already started and you wish to change it, proceed as follows:

- Open the door.
- Turn the dishwasher off with the  button.
- Turn the dishwasher on again with the  button.
- Select the desired program.
- Start the program by closing the door within four seconds.

The Optical Interface comes on to show that a program has been started.

Options

Options

You can select and deselect the options before starting the program using the appropriate buttons and the display

- Open the door.
- Turn the dishwasher on with the  button.

The indicator light next to the program selected will come on.

- Select a program.
- Press the button for the option you want.

The indicator light for the relevant button will come on if the option is available for the program selected.

If the option is not compatible with the program selected, a message to this effect will appear in the display.

- In this instance, confirm the message with OK.
- Start the program by closing the door.

The option selected will remain active for that particular program until the setting is changed.

Short

The Short option reduces the duration of programs in which this option is available by up to 30% (see “Program overview”). In order to achieve optimum cleaning results, energy consumption may increase slightly with this option.

When used in combination with the QuickIntenseWash program, the Short option results in a wash program without drying or automatic opening of the door (if available).

Extra economical



The Extra Economical option reduces the energy consumption of programs in which this option is available by up to 20%.

In order to achieve optimum cleaning results, the program duration is extended with this option.

FlexiTimer with EcoStart

The FlexiTimer  gives you three ways of starting the program by means of delaying the start. You can set the start time or the finish time of a program. You also have the option of taking advantage of time variable economy rates of electricity using the *EcoStart* function.

When using the delay start function, make sure that the detergent compartment is dry before adding detergent. Wipe dry with a cloth if necessary. If the compartment is wet, powder detergent can become lumpy and stick to the dispenser, with the result that it is not fully dispensed. Do not use liquid detergent when selecting delay start, as it can run into the dishwasher before it is required.

- Open the door.
- Switch the dishwasher on with the  button.
- Select the desired program.
- Press the  button.

The  indicator light will light up.

You can use the \vee \wedge arrow buttons to select the *Start at*, *Finish at*, or *EcoStart* function or *Back* .

- Confirm selection of the function you want with OK.

The set time will appear and the hour number block will be highlighted. You can now enter the time you want using the \vee \wedge arrow buttons and confirm with OK.

If, while you are setting the time, you do not press any buttons for several seconds, the display will revert to the previous menu. You will then have to enter your settings again.

If you open the door for more than four seconds before the start time is reached, the message *Continue with OK* appears in the display. Press the OK button and close the door within four seconds to restart the FlexiTimer.

Start at

With the *Start at* function, you set the exact time at which you want the program to start.

- Use the \vee \wedge arrow buttons to set the hour and confirm with OK.

The hour will be saved and the minute number block will be highlighted.

- Use the \vee \wedge arrow sensors to set the minutes and confirm with OK.

The saved start time for the program selected will appear in the display. The  indicator light will come on.

- Close the door within four seconds.

When the set time is reached, the program selected will begin automatically

Finish at

With the *Finish at* function, you set the time at which you wish the program to end.

- Use the \vee \wedge arrow buttons to set the hour and confirm with OK.

The hour will be saved and the minute number block will be highlighted.

- Use the \vee \wedge arrow sensors to set the minutes and confirm with OK.

The estimated start time for the program selected will appear in the display. The  indicator light will come on.

- Close the door within four seconds.

A message will appear in the display if the program cannot be completed by the set finish time because it has too long a running time. The program will start automatically when the estimated start time is reached.

EcoStart

The *EcoStart* function allows you to take advantage of time variable economy rates of electricity. Before you can use this option, you must set up to three electricity rate time zones (see “Settings menu - EcoStart”). You then set the latest time at which the program selected should end. The dishwasher will start automatically in the cheapest rate zone within the time set.

- Use the \vee \wedge arrow buttons to set the hour and confirm with OK.

The hour will be saved and the minute number block will be highlighted.

- Use the \vee \wedge arrow sensors to set the minutes and confirm with OK.

The estimated start time for the program selected will appear in the display. The  indicator light will come on.

- Close the door within four seconds.

The selected program will start automatically during the most cost effective time zone. It will finish at the latest by the set finish time.

Changing or deleting set times

You can change the set times or the program before the start time in the display is reached.

- Open the door.
- Press the  button.
- Use the \vee \wedge arrow buttons to select the setting you want to change and confirm with OK.
- Use the \vee \wedge arrow buttons to select the Change or Delete function and confirm with OK.

After confirming the Change function, you can change the set time.

After confirming the Delete function, the program duration will appear in the display for the selected program. The  indicator light will go out and the indicator light for the selected program will come on.

- Start the program by closing the door.

If you open the door for more than four seconds before the start time is reached, the message *Continue with OK* appears in the display. Press the OK button and close the door within four seconds to restart the FlexiTimer.

Cleaning and care

Check and clean your dishwasher regularly. This will help avoid problems and faults.

Warning! All surfaces are susceptible to scratching. Contact with unsuitable cleaning agents can alter or discolor all surfaces.

Cleaning the wash cabinet

Generally, the wash cabinet is self cleaning if the correct amount of detergent is used.

If, however, there are limescale or grease deposits in the wash cabinet, these can be removed with a special cleaning agent (available from Miele). Follow the instructions on the packaging.

If you mainly use low temperature programs (< 120°F/50 °C), there is a risk of bacteria and unpleasant odors building up in the wash cabinet. To prevent this happening the dishwasher will automatically increase the temperature in the final rinse of the selected program after several programs using low temperatures have been run.

- Clean the filters in the wash cabinet regularly

Cleaning the door and the door seal

Bacteria could build up on the door seal and the sides of the dishwasher door as these surfaces are outside the wash cabinet and are not accessed and cleaned by the spray arm jets.

- Wipe the door seals regularly with a damp cloth to remove food deposits.
- Wipe off any food or drink residues which may have dripped onto the sides of the dishwasher door before closing it.

Cleaning the control panel

- The control panel should only be wiped with a damp cloth.

Cleaning the indicator reflector panel

The indicator reflector panel for the Optical Interface / TimeControl function (depending on model) is situated in the cover plate underneath the counter.

- The indicator reflector panel should only be wiped with a damp cloth or a suitable cleaning agent designed for use on plastic.

Cleaning the door front

Warning! If soiling remains longer, it may happen that the surfaces can become discolored or changed. Remove any soiling immediately

- Clean the front with a solution of warm water and a little dishwashing liquid applied with a soft sponge. Wipe the surfaces dry using a soft cloth.

Warning! Glass cleaners may be used to clean the exterior. However do not allow them to sit or “puddle”, this can cause damage to the surface. Remove the cleaner promptly.

To better maintain your appliance avoid the following:

- Cleaning products containing soda, ammonia, acid, or chloride
- Descaling agents
- Abrasive cleaning products, such as scouring powder, scouring liquid, or pumice stones,
- Cleaners containing solvents
- Stainless steel cleaners
- Dishwasher cleaner
- Oven cleaners
- Glass cleaner
- Hard, abrasive brushes or sponges, e.g., pot scourers, brushes or sponges which have been previously used with abrasive cleaning agents

- Eraser sponges
- Sharp metal scrapers
- Steel wool
- Steam cleaning appliance

Filter system

The filter system in the base of the wash cabinet prevents food from being redeposited on dishes. It also protects the circulation pump from damage caused by foreign objects.

Warning! This dishwasher must not be used without all the filters in place!

Collection of coarse soil may cause the filters to clog. The level of soiling and time it takes before the filters need cleaning will vary depending on use.

The message Check filters will appear in the display after every 50 program cycles (factory default setting).

You can set the interval for the “Check filters” message to appear to a value between 30 and 60 program cycles (see “Settings menu - Check filters”).

- Check the filter system.
- Clean it if necessary.
- Then confirm the message with OK.

The message will go out.

Filter system

- Turn the dishwasher off.

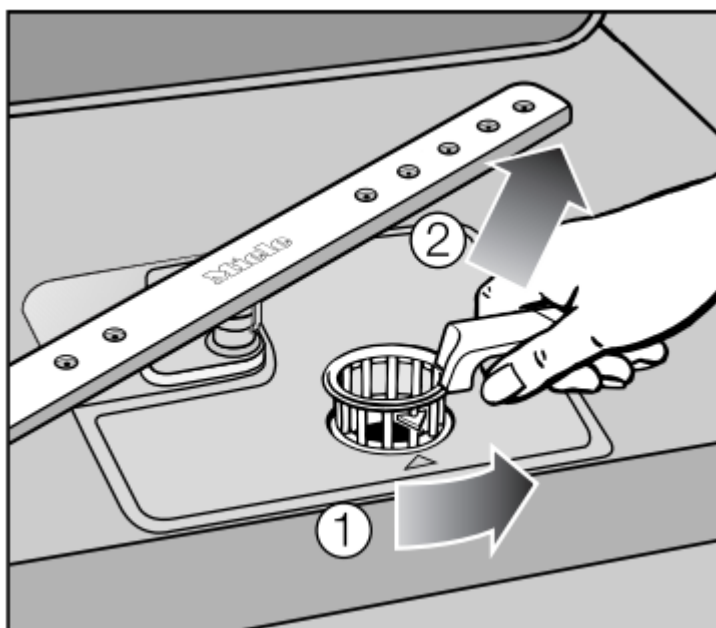

- Turn the handle counter-clockwise to release the filter system (1).

- Lift the filter system out of the dishwasher (2). Remove any coarse particles and rinse the filter well under running water. Use a nylon brush if necessary.

Warning! Ensure that coarse soil does not get into the circulation system and cause a blockage.

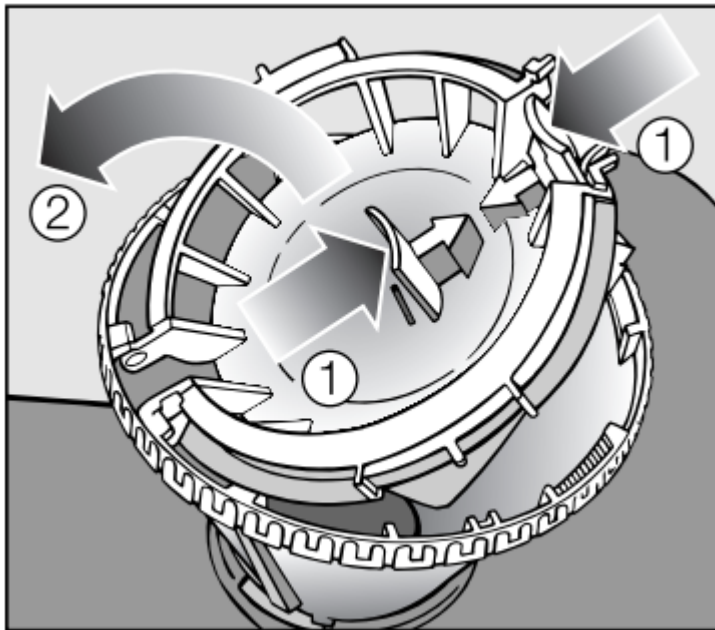

To clean the inside of the filter, the flap must be opened:

- Press catches (1) together in the direction of the arrows as shown, and open the filter (2).
- Rinse all the filters under running water.
- Then close the flap so that the catch engages.

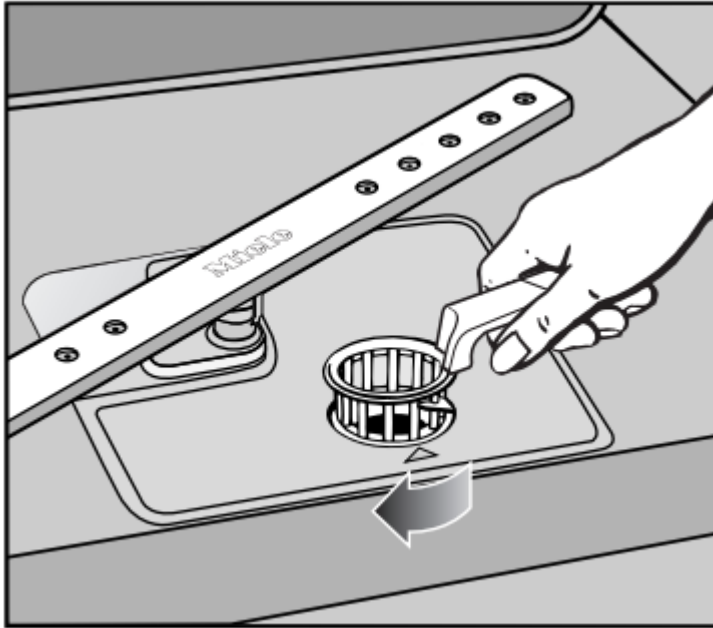

- Replace the filter system so that it lies flat in the base of the wash cabinet.
- Then turn the handle clockwise until both arrows point towards each other. This will lock the filter system in place.

Warning! Take care when you are fitting the filter system that it is secured in position correctly. Otherwise coarse soil could get into the circulation system and cause a blockage.

Cleaning the spray arms

Particles of food can get stuck in the spray arm jets and bearings. The spray arms should therefore be inspected and cleaned regularly (approx. every 4 - 6 months).

- Turn the dishwasher off.

Remove the spray arms as follows:

- Take out the cutlery tray (if your dishwasher is fitted with one).
- Push the top spray arm upwards to engage the inner ratchet. Then unscrew the spray arm.

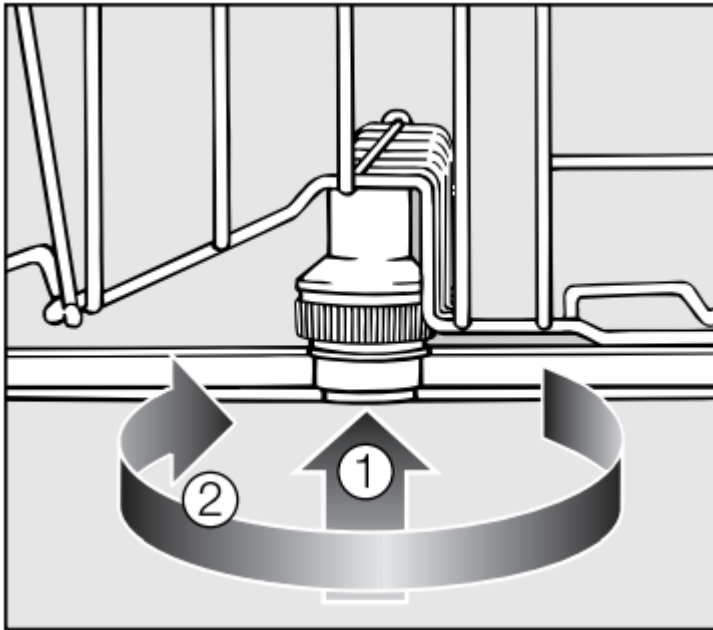

- Push the middle spray arm upwards (1) to engage the ratchet. Then unscrew the spray arm (2).
- Remove the lower basket.

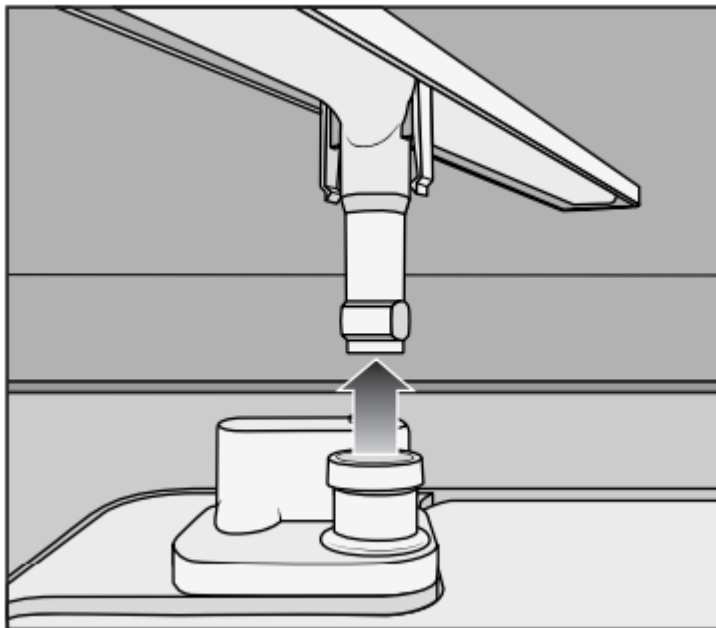

- Pull the lower spray arm firmly upwards to remove it.

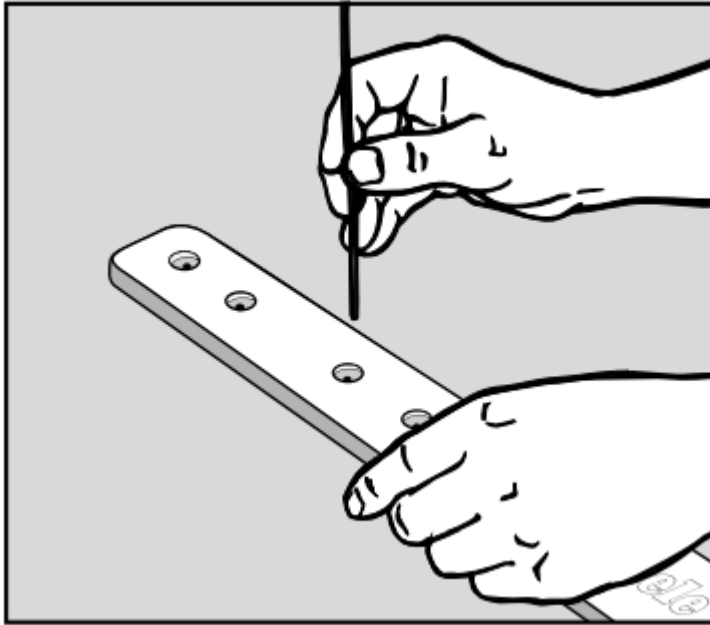

- Use a pointed object to push the food particles that are stuck in the spray arm jets into the spray arm.
- Rinse the spray arms thoroughly under running water.
- Replace the spray arms and check that they rotate freely.

Frequently Asked Questions





With the help of the following guide, minor faults in the performance of the appliance, some of which may result from incorrect operation, can be put right without contacting Miele Service. This will save time and money.

The following guide may help you to find the reason for a fault, and to correct it. You should, however, note the following:





Warning! Unauthorized or incorrect repairs could cause personal injury or damage to the appliance. Repair work to electrical appliances must only be carried out by a suitably qualified and competent person in strict accordance with current local and national safety regulations. The manufacturer cannot be held liable for unauthorized work.

Technical problems



Problem	Possible cause and solution
<p>The dishwasher does not start.</p>	<p>The door is not properly closed.</p> <ul style="list-style-type: none"> • Push the door firmly shut.
	<p>The dishwasher is not plugged in.</p> <ul style="list-style-type: none"> • Insert the plug.
	<p>The circuit breaker has tripped.</p> <ul style="list-style-type: none"> • Reset the fuse (see data plate for correct fuse rating).
	<p>The dishwasher is not switched on.</p> <ul style="list-style-type: none"> • Turn the dishwasher on with the start button.
<p>The dishwasher stops during a program.</p>	<p>The circuit breaker has tripped.</p> <ul style="list-style-type: none"> • Reset the fuse (see data plate for correct fuse rating). • If the circuit breaker trips again, contact Miele Service.
<p>After the program has started, the Optical Interface is not visible.</p>	<p>The indicator reflector panel was not fitted correctly.</p> <ul style="list-style-type: none"> • Refit the indicator reflector panel (see the installation plan).
<p>The buzzer is sounding. The program will not start.</p> <p>The In-operation indicator light is not lit up.</p>	<p>The door has not closed properly, because it has not been fully opened after the door had closed automatically.</p> <ul style="list-style-type: none"> • Open the door fully so that the locking pins retract again. • Then close the door.

<p>The Optical Interface is flashing quickly.</p> <p>The buzzer is sounding. One of the following faults appears in the display:</p>	<p>Before fixing the fault:</p> <ul style="list-style-type: none"> • Turn the dishwasher off button.
<p> <i>Fault FXX</i></p>	<p>There may be a technical fault.</p> <p>After a few seconds:</p> <ul style="list-style-type: none"> • Turn the dishwasher back on • Select the desired program • Close the door. <p>If the error message is displayed again, it is a technical fault.</p> <ul style="list-style-type: none"> • Contact Miele Service.
<p> <i>Waterproof</i></p>	<p>The WaterProof System has reacted.</p> <ul style="list-style-type: none"> • Turn off the water supply. • Contact Miele Service.
<p> <i>Fault F78</i></p>	<p>A fault has occurred in the circulation system.</p> <ul style="list-style-type: none"> • Turn the dishwasher off for 30 seconds with the  button. • Turn the dishwasher back on • Select the desired program • Close the door. <p>If the error message is displayed again, it is a technical fault.</p> <ul style="list-style-type: none"> • Contact Miele Service.

Water intake fault

Problem	Possible cause and solution
<p>The In-operation indicator light is flashing quickly.</p> <p>The buzzer is sounding.</p> <p>One of the following faults appears in the display:</p>	
<p> <i>Open water supply</i></p>	<p>The water supply is turned off.</p> <ul style="list-style-type: none"> • Turn on the water supply fully.
<p> <i>Intake</i></p>	<p>Before fixing the fault:</p> <ul style="list-style-type: none"> • Turn the dishwasher off with the  button. <p>There is a problem with the water intake.</p> <ul style="list-style-type: none"> • Turn on the water supply fully and start the program again. • Clean the water intake filter (see “Frequently asked questions”). • The water pressure at the intake is lower than 4.35 psi. • Contact a plumber.
<p>The following message appears in the display during the <i>Energy Saver</i> program:</p> <p> <i>Intake temp. low</i></p>	<p>The intake water has not reached the required temperature of 120°F (45°C) (see “Water connection, Water intake”).</p> <ul style="list-style-type: none"> • Start the program again. • If the fault message appears again, select a different program.

Water drainage fault

Problem	Possible cause and solution
<p>The Optical Interface is flashing quickly.</p> <p>The buzzer is sounding.</p> <p>The following fault appears in the display:</p> <p> <i>Drain</i></p>	<p>Before fixing the fault:</p> <ul style="list-style-type: none"> • Turn the dishwasher off with the  button. <hr/> <p>There is a problem with the water intake.</p> <p>There might be water in the wash cabinet.</p> <ul style="list-style-type: none"> • Clean the filter system (see “Cleaning and care -Filter system”). • Clean the drain pump (see “Frequently asked questions”). • Clean the non-return valve (see “Frequently asked questions”). • Remove any kink or loop in the drain hose.

General problems

Problem	Possible cause and solution
<p>The Optical Interface is flashing quickly.</p> <p>The warning buzzer is sounding.</p> <p>The indicator light of the selected program and the message <i>Continue with OK</i> will appear in the display.</p> <p>The dishwasher does not start or the Flex-iTimer stops running.</p>	<p>The safe mode of the dishwasher was activated.</p> <p>The following takes place:</p> <ul style="list-style-type: none"> - If you do not close the door within four seconds of the last press of a button at program start - If the door is open for longer than four seconds during a program or within the delay start time <ul style="list-style-type: none"> • Press the OK and close the door within four seconds.
<p>Detergent residue is left in the dispenser at the end of a program.</p>	<p>The dispenser was still damp when detergent was added.</p> <ul style="list-style-type: none"> • Make sure the dispenser is dry before adding detergent.
<p>The dispenser cover cannot be closed.</p>	<p>Detergent residue is blocking the latch.</p> <ul style="list-style-type: none"> • Remove the detergent residue.
<p>The inside of the door and/or the interior walls are wet after a program has finished.</p>	<p>This is caused by the drying system and does not indicate a fault. The moisture will dissipate after a while.</p>
<p>Water remains in the wash cabinet at the end of a program.</p>	<p>Before fixing the fault:</p> <ul style="list-style-type: none"> • Turn the dishwasher off with the  button.
	<p>The filter system in the wash cabinet is clogged.</p> <ul style="list-style-type: none"> • Clean the filter system (see “Cleaning and care -Filter system”).

	<p>The drain pump or non-return valve is blocked.</p> <ul style="list-style-type: none"> • Clean the drain pump or the non-return valve (see “Frequently asked questions”).
	<p>The drain hose is kinked.</p> <ul style="list-style-type: none"> • Remove the kink.

Noise

Problem	Possible cause and solution
There is a knocking noise in the wash cabinet.	<p>A spray arm is hitting the dishes.</p> <ul style="list-style-type: none"> • Interrupt the program, and rearrange the items which are obstructing the spray arm.
There is a rattling noise in the wash cabinet.	<p>Dishes is moving around in the wash cabinet.</p> <ul style="list-style-type: none"> • Interrupt the program and rearrange loose pieces.
	<p>A foreign object (e.g., a cherry pit) has become lodged in the drain pump.</p> <ul style="list-style-type: none"> • Remove the foreign object from the drain pump (see “Maintenance - Cleaning the drain pump and non-return valve”).
There is a knocking noise from the water pipe	<p>This may be caused by the installation or the diameter of the water pipe.</p> <ul style="list-style-type: none"> • This has no influence on dishwasher function. If in doubt, contact a suitably qualified plumber.

Poor cleaning results



Problem	Possible cause and solution
<p>The dishes are not clean.</p>	<p>The dishes were not loaded correctly.</p> <ul style="list-style-type: none"> • See notes in “Loading the dishwasher”.
	<p>The program was not powerful enough.</p> <ul style="list-style-type: none"> • Select a more intensive program (see “Program overview”).
	<p>Not enough detergent was dispensed.</p> <ul style="list-style-type: none"> • Use more detergent, or change your detergent.
	<p>Items are blocking the path of the spray arms.</p> <ul style="list-style-type: none"> • Rearrange the items so that the spray arms can rotate freely.
	<p>The filter system in the base of the wash cabinet is not clean or is not correctly fitted.</p> <p>This may cause the spray arm jets to get blocked.</p> <ul style="list-style-type: none"> • Clean and/or fit the filter system correctly. • Clean the spray arm jets if necessary (see “Cleaning and care - Cleaning the spray arms”).



	<p>The non-return valve is open and blocked. Dirty water has flowed back into the wash cabinet.</p> <ul style="list-style-type: none"> • Clean the drain pump and the non-return valve (see “Frequently asked questions”).
<p>Smearing appears on glassware and cutlery. There is a bluish sheen on the surface of glassware; film can be wiped off.</p>	<p>The rinse aid dosage is set too high.</p> <ul style="list-style-type: none"> • Reduce the dosage (see “Settings menu - Rinse aid”).
<p>Dishes is not dry or cutlery and glasses are spotty.</p>	<p>The rinse aid dosage is set too low or the rinse aid reservoir is empty.</p> <ul style="list-style-type: none"> • Replenish the reservoir, increase the dosage, or change the brand of rinse aid (see “Before using for the first time - Rinse aid”). <p>Dishes was taken out of the cabinet too soon.</p> <ul style="list-style-type: none"> • Leave it in for longer (see “Operation”). <p>Combination tabs have been used which have impaired drying performance.</p> <ul style="list-style-type: none"> • Change your detergent, or replenish the rinse aid (see “Before using for the first time - Rinse aid”).
<p>Glasses have a brownish-blue discoloration; the deposit cannot be wiped off.</p>	<p>Detergent deposits.</p> <ul style="list-style-type: none"> • Switch to another detergent.

<p>Glasses are dull and discolored; the deposit cannot be wiped off.</p>	<p>The glassware is not dishwasher-safe. The surfaces are affected.</p> <ul style="list-style-type: none"> • There is no remedy. <p>Purchase glassware which is dishwasher-safe.</p>
<p>Tea or lipstick stains have not been completely removed.</p>	<p>The wash temperature of the selected program was too low.</p> <ul style="list-style-type: none"> • Select a program with a higher wash temperature. The bleaching effect of the detergent is too low. • Switch to another detergent.
<p>Plastic parts are discolored.</p>	<p>Natural dyes, e.g., from carrots, tomatoes, or ketchup may be the cause. The amount of detergent used or its bleaching effect was not sufficient to deal with natural dyes.</p> <ul style="list-style-type: none"> • Use more detergent (see “Operation - Detergent”). Discoloration is irreversible.
<p>White residue is visible on dishes and cutlery, clouding occurs on glassware; this film can be wiped off.</p>	<p>The rinse aid dosage is too low.</p> <ul style="list-style-type: none"> • Increase the dosage (see “Settings menu, Rinse aid”).
	<p>The salt reservoir is empty.</p> <ul style="list-style-type: none"> • Fill the salt reservoir (see “Before using for the first time, Dishwasher salt”).
	<p>The salt reservoir cap has not been screwed on correctly.</p> <ul style="list-style-type: none"> • Replace it, making sure that it screws back on correctly.



	<p>An unsuitable Tab detergent has been used.</p> <ul style="list-style-type: none"> • Change your detergent.
	<p>The softener assembly is programmed too low for the water hardness level.</p> <ul style="list-style-type: none"> • Program the softener assembly to a higher water hardness level (see “Settings menu, Water hardness”).
<p>There are rust stains on the cutlery.</p>	<p>The affected items are not corrosion resistant.</p> <ul style="list-style-type: none"> • There is no remedy. <p>Purchase cutlery which is dishwasher-safe.</p>
	<p>A program was not run after dishwasher salt was added. Traces of salt have got into the wash cycle.</p> <ul style="list-style-type: none"> • Always run the <i>QuickIntenseWash</i> program with the <i>Short</i> programming option selected and without any dishes in the dishwasher after adding dishwasher salt.
	<p>The salt reservoir cap has not been screwed on correctly.</p> <ul style="list-style-type: none"> • Replace it, making sure that it screws back on correctly.



Cleaning the drain pump and non-return valve

If the water has not been pumped away at the end of a program, the drain pump or the non-return valve might be blocked. They are, however, easy to clean.

- Disconnect the dishwasher from the electrical supply. Turn off the dishwasher and withdraw the plug.
- Take the filter system out of the wash cabinet (see “Cleaning and care, Cleaning the filters”).
- Scoop the water out of the wash cabinet using a suitable container or utensil.

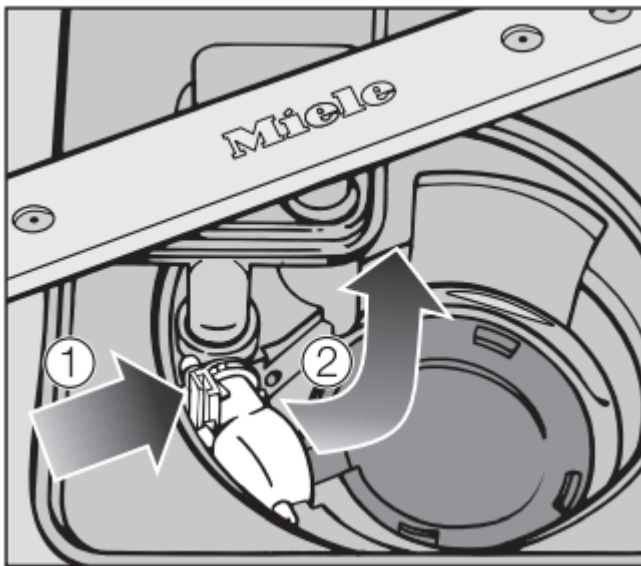

- Press the catch for the non-return valve inwards (1).
- Tilt the non-return valve inwards until it is released (2).
- Rinse it thoroughly under running water and remove any dirt from the nonreturn valve.

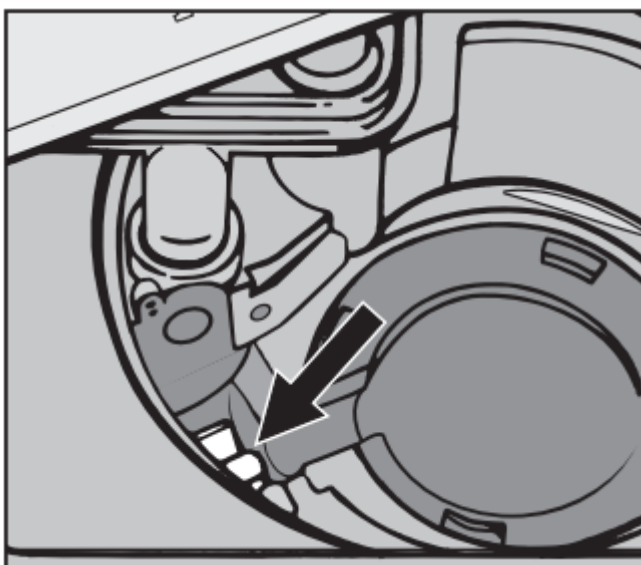

The drain pump is located underneath the non-return valve (see arrow).

- Remove all foreign objects from the drain pump (glass or bone splinters). Before returning the non-return valve, check that the drain pump is not blocked. Spin the impeller several times in both directions to check for obstructions.
- Carefully reinsert the non-return valve and secure it with the locking clamp.

Warning! Make sure the locking clamp clicks into place! Be careful not to damage any delicate components when cleaning the drain pump and the non-return valve.

Warning

This content is compiled from multiple sources and is provided for reference purposes only. It may not be complete or fully applicable to all situations. If you are unable to resolve your issue, please contact the product manufacturer or an authorized service provider for official support.

Document generated by [ManualsFile](#)