

## Operating Instructions

### About the features of your oven.

Throughout this manual, features and appearance may vary from your model.

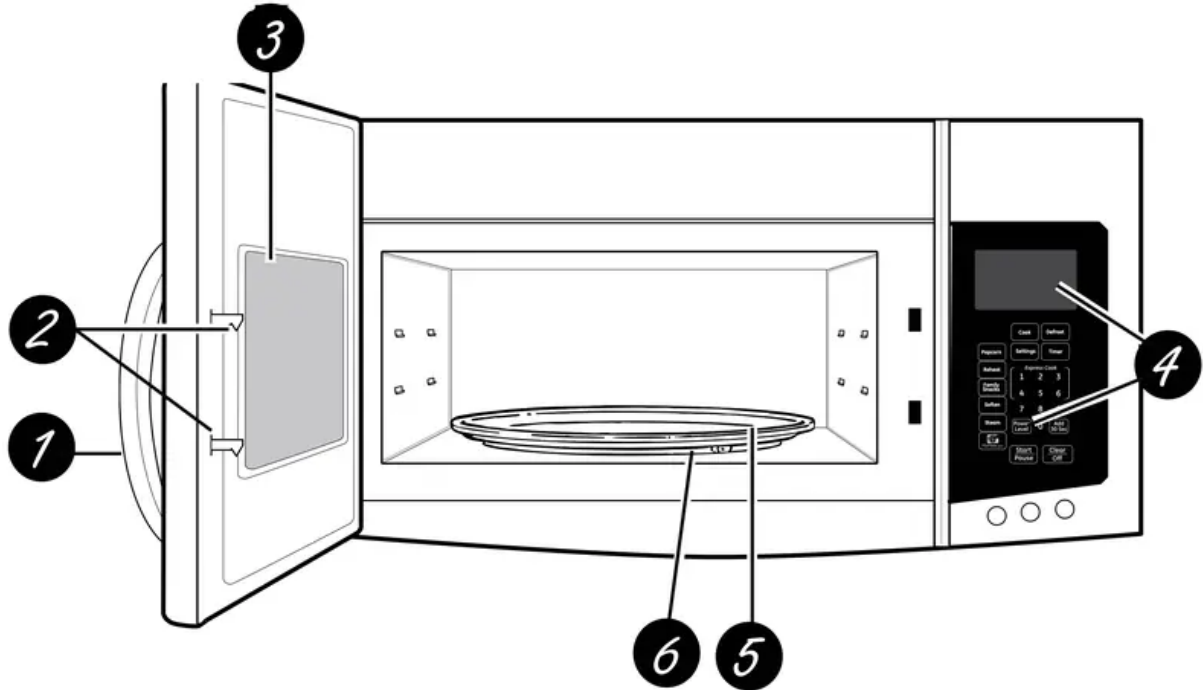

### Features of the Oven

1. **Door Handle.**
2. **Door Latches.**
3. **Window with Metal Shield.**  
Screen allows cooking to be viewed while keeping microwaves confined in the oven.
4. **Control Panel.**
5. **Removable Turntable.**  
Do not operate the oven in the microwave mode without the turntable and turntable support seated and in place.
6. **Removable Turntable Support.**  
Do not operate the oven in the microwave mode without the turntable and turntable support seated and in place.

### Power Saver (Energy Saver) Feature (on some models)

Your GE microwave has an Power Saver (Energy Saver) feature. Many electronic appliances, including Microwaves, consume electric power while they are switched off or in a standby mode. Eliminating standby power can reduce your operating costs.

To ACTIVATE the Power Saver (Energy Saver) Feature-

1. Press the Power Saver button on the unit, and the unit will turn off. (Note: If utilizing this feature, the clock will not be displayed on the unit).

To DEACTIVATE the Power Saver (Energy Saver) Feature-

1. Press the Power Saver button on the unit, and the unit will turn on. The display will read "On" If the unit has had power applied recently (within the last few days), the time will be remembered.
2. If prompted, enter the time of day.

**NOTE:** The time keeping device that keeps your clock running will need to be recharged every few days. It is recommended that once a week you should leave the unit powered on (do not use the Power Saver (Energy Saver) feature for at least 24 hours. If you are prompted to enter a time when turning on from the Power Saver (Energy Saver) mode, you should have the unit powered on for at least 48 hours. When you first install your unit, you should leave it powered on for at least 48 hours.

Some features, such as the auto night light, will not function when you are in Power Saver (Energy Saver) mode.

**NOTE:** This microwave oven does not detect food in the oven if food was inserted while the unit was Off (Power Saver (Energy Saver) active or power loss). As a result, it will ask you to insert food again when Power Saver (Energy Saver) is deactivated or power is restored to the unit. If this occurs, just open and close the door to clear the message and the oven will be ready for cooking.

### **About the cooking features of your microwave oven.**

Throughout this manual, features and appearance may vary from your model.

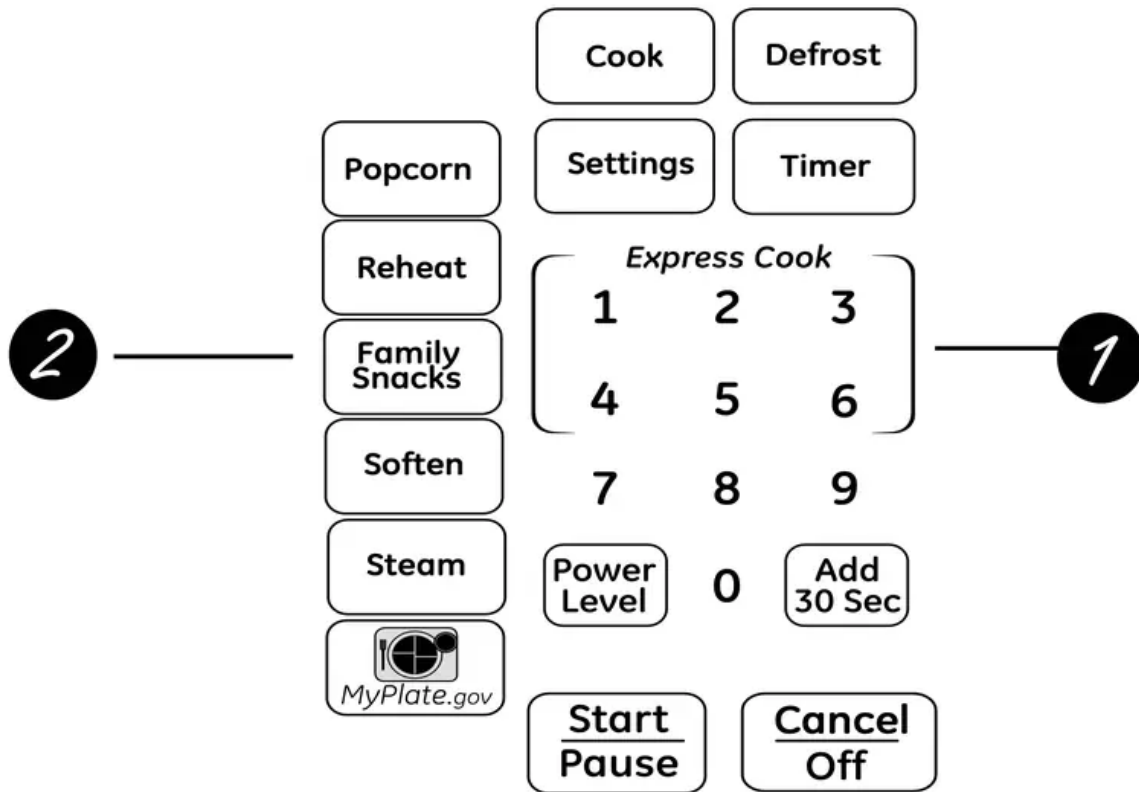

## Cooking Controls

Check the Convenience Guide before you begin.

### 1 Time Features

<i>Press</i>	<i>Enter</i>
COOK	Amount of cooking time
DEFROST	Time, Weight or 1lb Quick Defrost
SETTINGS	
TIMER	
POWER LEVEL	Power level 1 to 10
ADD 30 SEC	Starts immediately!
EXPRESS COOK	Starts immediately! Press number pads (1-6)

### 2 Convenience Features

<i>Press</i>	<i>Enter</i>
POPCORN	Starts immediately!
REHEAT	Starts immediately!
FAMILY SNACKS	Enter pad to select Food
SOFTEN	Enter pad to select Food
STEAM	Enter pad to select Food
MyPlate.gov (MyPyramid)	Enter pad to select Food

About the time feature

Time Cook



*Express Cook*

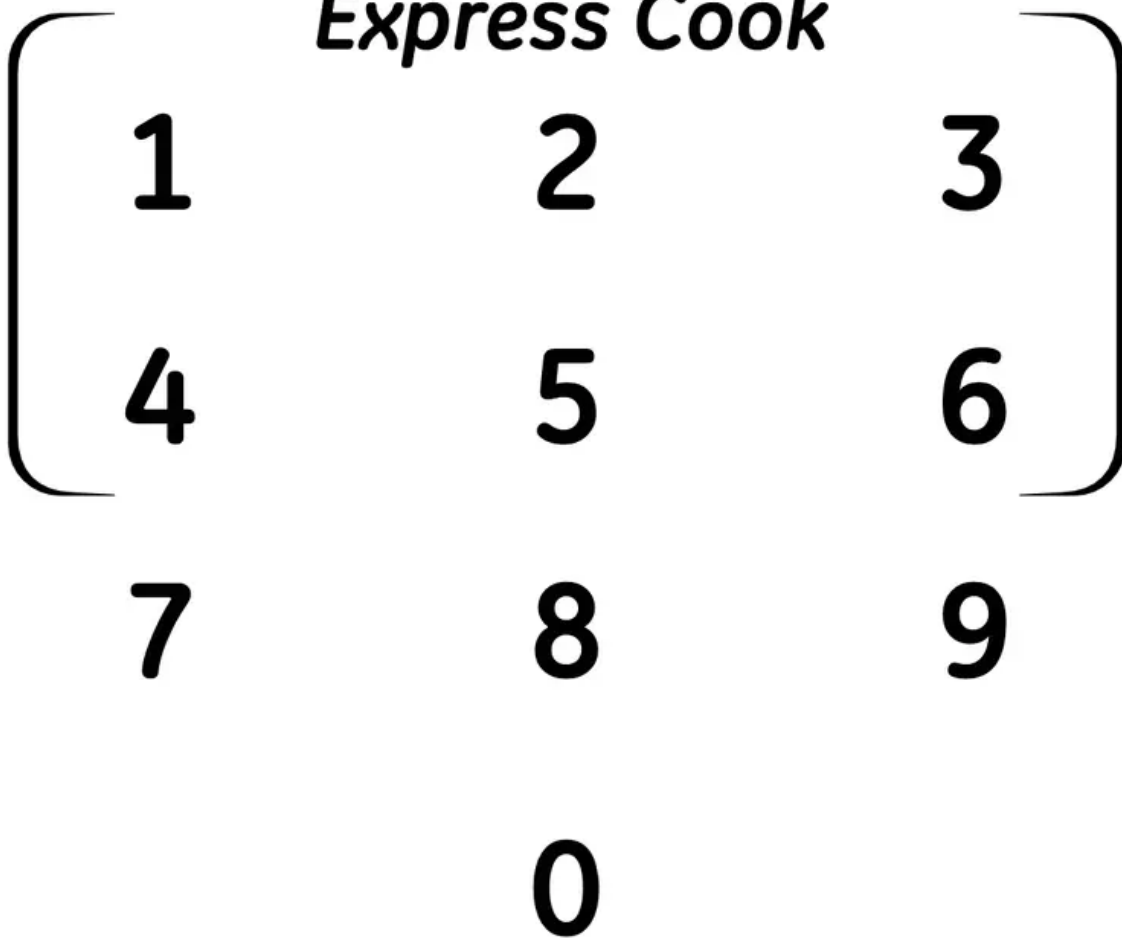

Allows you to microwave for any time up to 99minutes and 99 seconds.

Power level 10 (HIGH) is automatically set, but you may change it for more flexibility.

1. Press TIME COOK.
2. Enter cooking time.
3. Press START or change power level.
4. Press START if power setting is chosen.

You may open the door during Time Cook to check the food. Close the door and press START to resume cooking.

### Express Cook

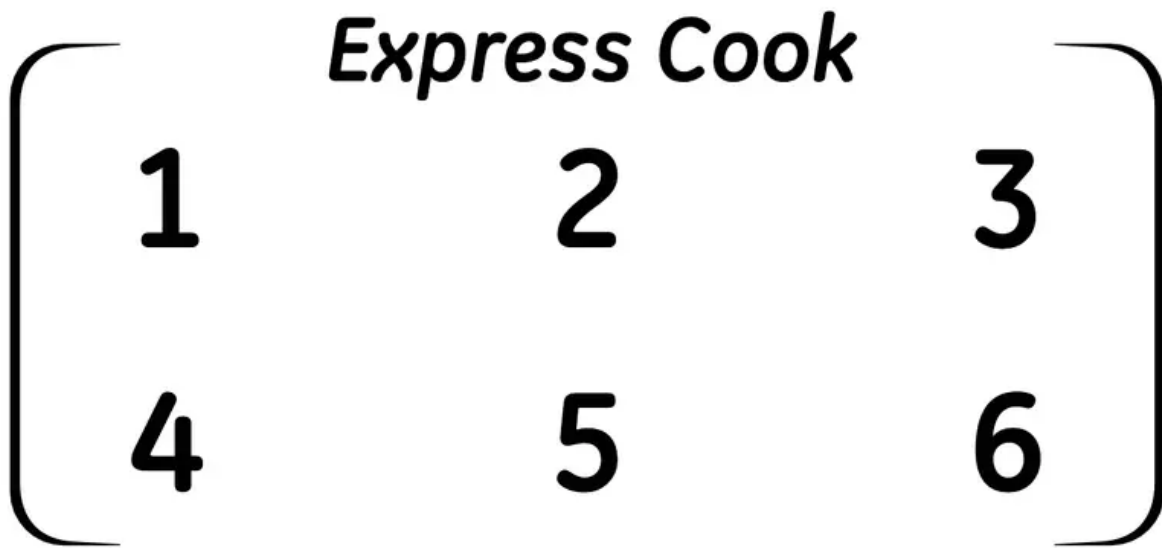

This is a quick way to set cooking time for 1-6 minutes.

1. Press one of the Express Cook pads (from 1-6) for 1-6 minutes of cooking at power level 10.

For example, press the 2 pad for 2 minutes of cooking time.

The power level can be changed as time is counting down. Press POWER LEVEL and enter 0-10.

**NOTE:** Express Cook function pertains to pads 1-6 only.

### Add 30 Sec

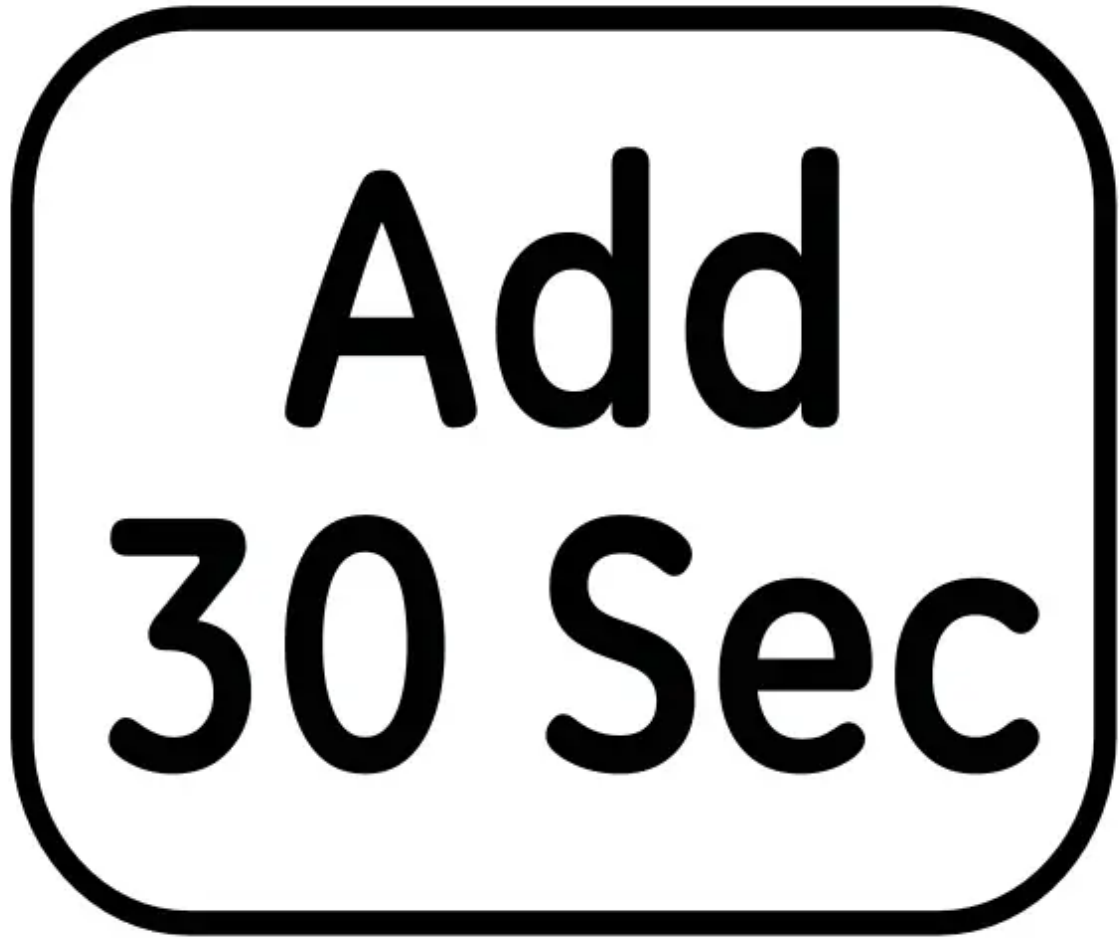

It will add 30 seconds to the time counting down each time the pad is pressed. Each touch will add 30 seconds, up to 99 minutes and 99 seconds.

The oven will start immediately when pressed.

**Time Defrost**

**Defrost**

***Express Cook***

**1**                      **2**                      **3**  
**4**                      **5**                      **6**

**7**

**8**

**9**

**0**

**Start**  

---

**Pause**



Allows you to defrost for a selected length of time. See the Defrosting Guide for suggested times. (Time Defrost and 1 lb Quick Defrost explained in the About the convenience features section).

1. Press DEFROST twice.
2. Enter defrosting time.
3. Press START.
4. Turn the food over after half the time.

At one half of selected defrosting time, turn food over and break apart or rearrange pieces for more even defrosting. Shield any warm areas with small pieces of foil. The oven will continue to defrost if you don't open the door and turn the food.

A dull thumping noise may be heard during defrosting. This is normal when oven is not operating at High power.

### ***Defrosting Tips***

- Foods frozen in paper or plastic can be defrosted in the package. Closed packages should be slit, pierced or vented AFTER food has partially defrosted. Plastic storage containers should be partially uncovered.
- Family-size, prepackaged frozen dinners can be defrosted and microwaved. If the food is in a foil container, transfer it to a microwave-safe dish.
- Foods that spoil easily should not be allowed to sit out for more than one hour after defrosting. Room temperature promotes the growth of harmful bacteria.
- For more even defrosting of larger foods, such as roasts, use Time Defrost. Be sure large meats are completely defrosted before cooking.
- When defrosted, food should be cool but softened in all areas. If still slightly icy, return to the microwave very briefly, or let it stand a few minutes.

### ***Defrosting Guide***

<b>FOOD</b>	<b>TIME</b>	<b>COMMENTS</b>
<b>Bread, Cakes</b> <i>Bread, buns, or rolls</i> (1 piece) <i>Sweet rolls</i> (approx. 12 oz)	1/4 min. 2 to 4 min.	Rearrange after half the time
<b>Fish and Seafood</b> <i>Filletts, Frozen</i> (1 lb)	6 to 9 min.	
<b>Fruit</b> <i>Plastic Pouch - 1 or 2</i> (10-oz package)	1 to 5 min.	
<b>Meat</b> <i>Bacon</i> (1 lb)  <i>Franks</i> (1 lb)  <i>Ground meat</i> (1 lb)  <i>Roast: beef, lamb, veal, pork</i>  <i>Steaks, chops and cutlets</i>	2 to 5 min.  2 to 5 min.  4 to 6 min.  9 to 13 min. per lb.  4 to 8 min. per lb.	Place unopened package in oven. Let stand 5 minutes after defrosting.  Place unopened package in oven. Microwave just until franks can be separated. Let stand 5 minutes, if necessary, to complete defrosting.  Turn meat over after first half of time.  Use power level 10.  Place unwrapped meat in cooking dish. Turn over after first half of time and shield warm areas with foil. After second half of time, separate pieces with table knife. Let stand to complete defrosting.
<b>Poultry</b> <i>Chicken, broiler-fryer, cut up</i> (2½ to 3 lbs.)  <i>Chicken, whole</i> (2½ to 3 lbs.)  <i>Ground meat</i> (1 lb)  <i>Turkey breast</i> (4 to 6 lbs.)	14 to 20 min.  20 to 25 min.  7 to 13 min. per lb.  3 to 8 min. per lb.	Place wrapped chicken in dish. Unwrap and turn over after first half of time. After second half of time, separate pieces and place in cooking dish. Microwave 2 to 4 minutes more, if necessary. Let stand a few minutes to finish defrosting.  Place wrapped chicken in dish. After half the time, unwrap and turn chicken over. Shield warm areas with foil. To complete defrosting, run cold water in the cavity until giblets can be removed.  Place unwrapped hen in the oven breast-side-up. Turn over after first half of time. Run cool water in the cavity until giblets can be removed.  Place unwrapped breast in microwave-safe dish breast-side-down. After first half of time, turn breast-side-up and shield warm areas with foil. Defrost for second half of time. Let stand 1 to 2 hours in refrigerator to complete defrosting.

## About the convenience features

### Auto Defrost

**Defrost**

***Express Cook***

**1**

**2**

**3**

**4**

**5**

**6**

**7**

**8**

**9**

**0**

**Start**  

---

**Pause**

Use Auto Defrost for meat, poultry and fish. Use Time Defrost for most other frozen foods.

1. Press DEFROST once.
2. Using the conversion guide below, enter food weight. For example, press pads 1 and 2 for 1.2 pounds (1 pound, 3 ounces).
3. Press START.
4. Turn the food over when prompted.  
(Time Defrost is explained in the About the Time Features section).

### ***Defrosting Tips***

- Remove meat from package and place on microwave-safe dish.
- When the oven signals, turn the food over. Remove defrosted meat or shield warm areas with small pieces of foil.
- After defrosting, most meats need to stand 5 minutes to complete defrosting. Large roasts should stand for about 30 minutes.

### ***Conversion Guide***

If the weight of food is stated in pounds and ounces, the ounces must be converted to tenths (.1) of a pound.

<b>Ounces</b>	<b>Pounds</b>
1-2	.1
3	.2
4-5	.3
6-7	.4
8	.5
9-10	.6
11	.7
12-13	.8
14-15	.9

1 lb Quick Defrost



**Defrost**

***Express Cook***

**1                      2                      3**

**4                      5                      6**

**7                      8                      9**

**0**

**Start**  

---

**Pause**



1 lb Quick Defrost automatically sets the defrosting times and power levels to give even defrosting results for meats, poultry and fish weighing up to one pounds.

1. Press DEFROST three times.
2. Press START.
3. Turn the food over when prompted.



About the MyPlate.gov (MyPyramid) Feature

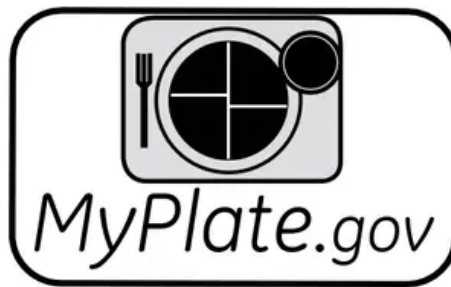

***Express Cook***

<b>1</b>	<b>2</b>	<b>3</b>
<b>4</b>	<b>5</b>	<b>6</b>
<b>7</b>	<b>8</b>	<b>9</b>
	<b>0</b>	

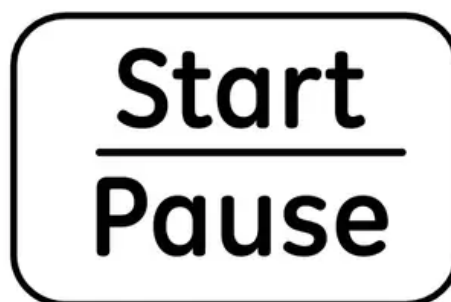

## MyPlate.gov (MyPyramid) Feature

Allows you to microwave healthy food choices by servings or with sensor.

1. Press MyPlate.gov (MyPyramid) pad.
2. Enter the food type. See Cooking Guide for MyPlate.gov (MyPyramid) below for codes or check the display for food types.
3. Enter the amount as prompted for non-sensor food selections.
4. NOTE FOR SENSOR COOKING: for best results do not open the door while cooking.
5. Press START.

For non-sensor foods, you may open the door during cooking to check the food. Close the door and press START to resume cooking.

**NOTE:** Do not use the sensor features twice in succession on the same food portion. If food is undercooked after the first countdown, use TIME COOK for additional time.

### Cooking Guide for MyPlate.gov (MyPyramid) Feature

**NOTE:** Use power level 10 unless otherwise noted.

<i>First Choice</i>	<i>Second Choice</i>	<i>Third Choice</i>
1 - Grain	1 - Rice	1 - 1/2 cup, 2 - 1 cup, 3 - 1 1/2 cups
	2 - Oatmeal	1 to 4 packets
	3 - Popcorn	1 - 1oz, 2 - 3.0 ozs, 3 - 3.5 ozs
	4 - Macaroni	1 - 1/2 cup, 2 - 1 cup, 3 - 1 1/2 cups
	5 - Quinoa	1 - 1/2 cup, 2 - 1 cup, 3 - 1 1/2 cups
2- Vegetables	1 - Asparagus	1 - Fresh, 2 - Frozen, 3 - Canned
	2 - Broccoli	1 - Fresh, 2 - Frozen
	3 - Green Beans	1 - Fresh, 2 - Frozen, 3 - Canned
	4 - Carrots	1 - Fresh, 2 - Frozen, 3 - Canned
	5- Corn	1 - Fresh Cobs (1 to 4), 2 - Frozen Kernals, 3 - Canned
	6 - Peas	1 - Frozen, 2 - Canned
	7 - Potatoes	1 - Baking, 2 - Sweet
	8 - Spinach	1 - Fresh, 2 - Frozen, 3 - Canned
3 - Ground Meat		
4 - Poultry	1 - Bone-in Chicken	
	2 - Bonless Chicken	
5 - Seafood	1 - Whitefish	
	2 - Tilapia	
	3 - Salmon	

## About the sensor microwave features

### Family Snacks

# Family Snacks

Use the Family Snacks feature to cook from a variety of pre-programmed family snack items.

1. Press the Family Snacks button.
2. Enter the number pad to select one of the eight snack options.
3. Enter an amount for the snack selected.
4. Press START/PAUSE to start cooking.

<b>First Choice</b>	<b>Second Choice</b>
1 - Burrito	1 to 3
2 - Chicken Nuggets	1 to 2 servings
3 - Oatmeal	1 to 4 packets
4 - Instant Macaroni and Cheese	1 to 2 servings
5 - Canned Pasta	1 to 2 cans
6 - Hot Dogs	1 to 4
7 - Pizza (5 inch)	
8 - Hot Chocolate	1 to 3 cups

Soften (on some models)



Use the Soften feature to soften certain pre-programmed foods:

1. Press the Soften button.

2. Enter the number pad to select one of the soften options.
3. Enter an amount for the food selected.
4. Press START/PAUSE to start cooking.

First Choice	Second Choice
1 - Butter	1 - 1/2 Stick; 2 - 1 Stick; 3 - 2 Sticks
2 - Cream Cheese	1 - 3 ounces; 2 - 8 ounces;
3 - Ice Cream	1 - 1 pint; 2 - 1 quart;

Soften/Melt (on some models)



Use the Soften/Melt feature to soften or melt certain pre-programmed foods:

1. Press the Soften/Melt button. Press one time for soften and two times for melt.
2. Enter the number pad to select one of the soften or melt options.
3. Enter an amount for the food selected.
4. Press START/PAUSE to start cooking.

<b>First Choice</b>	<b>Second Choice</b>
1 - Butter	1 - 1/2 Stick; 2 - 1 Stick; 3 - 2 Sticks
2 - Caramel	1 - 4 ounces; 2 - 8 ounces; 3 - 12 ounces; 4 - 16 ounces
3 - Chocolate	1 - 4 ounces; 2 - 8 ounces; 3 - 12 ounces; 4 - 16 ounces
4 - Marshmallows	1 - 5 ounces; 2 - 8 ounces; 3 - 10 ounces; 4 - 16 ounces

## Steam



Use the Steam feature to steam certain pre-programmed foods. For best performance, please use a NordicWare Rice Cooker/Steamer Bowl.

1. Press the Steam button.
2. Select the food you wish to steam.

3. Place steamer bowl with water, salt (if necessary), and food in the microwave with the steam vents on the steamer bowl in the OPEN position.
4. Press START to begin cooking.
5. When prompted, open the door and CLOSE the steam vents on the steamer bowl.  
**NOTE:** Make sure to open the door and close the steam vents on the steamer bowl when prompted. If the START button is pressed before opening the door, the oven will display the "Insert Food" message.
6. Close the door and press START/PAUSE to resume cooking.

**NOTE:** The NordicWare Rice Cooker/Steamer Bowl should be used for best cooking results.

<b>First Choice</b>	<b>Second Choice</b>
1 - Rice	1 - 1 cup white, 2 - 1 cup brown
2 - Asparagus	1 to 2 cups
3 - Broccoli	1 to 2 cups
4 - Brussel Sprouts	1 to 2 cups
5 - Carrots	1 to 2 cups
6 - Cauliflower	1 to 2 cups
7 - Zucchini	1 to 2 cups

### Popcorn



# Popcorn

To use the Popcorn feature:

1. Follow package instructions, using Cook if the package is less than 1.0 ounces or larger than 3.5 ounces. Place the package of popcorn in the center of the turntable.
2. Press the POPCORN button once for 3.3 to 3.5 ounce bags or twice for 2.7 to 3.0 ounce bags or three times for 1.0 to 1.5 ounce bags.

If food is undercooked after the countdown, use Time Cook for additional cooking time.

Use only with prepackaged microwave popcorn weighing 1.0 to 3.5 ounces.

**NOTE:** Do not use this feature twice in succession on the same food portion - it may result in severely overcooked or burnt food

## Reheat

# Reheat

Do not use the shelves when microwave cooking.

The Reheat feature reheats servings of previously cooked foods or a plate of leftovers.

1. Place the cup of liquid or covered food in the oven. Press REHEAT once, twice, or three times. The oven starts immediately.  
Press once for a plate of leftovers.  
Press twice for a pasta.  
Press three times for 1/2 to 2 cups of vegetables.
2. The oven signals when steam is sensed and the time remaining begins counting down.

Do not open the oven door until time is counting down. If the door is opened, close it and press START/PAUSE immediately.

After removing food from the oven, stir, if possible, to even out the temperature. Reheated foods may have wide variations in temperature. Some areas of food may be extremely hot.

If food is not hot enough after the countdown use Time Cook for additional reheating time.

### ***Some Foods Not Recommended for Use With Reheat***

It is best to use Time Cook for these foods:

- Bread products.
- Foods that must be reheated uncovered.
- Foods that need to be stirred or rotated.
- Foods calling for a dry look or crisp surface after reheating.

**NOTE:** Do not use this feature twice in succession on the same food portion - it may result in severely overcooked or burnt food.

### **Humidity Sensor**

What happens when using the Sensor Features:

The Sensor Features detect the increasing humidity released during cooking. The oven automatically adjusts the cooking time to various types and amounts of food.

Do not use the Sensor Features twice in succession on the same food portion - it may result in severely overcooked or burnt food. If food is undercooked after the countdown, use Time Cook for additional cooking time.

- The proper containers and covers are essential for best sensor cooking.
- Always use microwave-safe containers and cover them with lids or vented plastic wrap. Never use tight sealing plastic containers - they can prevent steam from escaping and cause food to overcook.
- Be sure the outside of the cooking containers and the inside of the microwave oven are dry before placing food in the oven. Beads of moisture turning into steam can mislead the sensor.

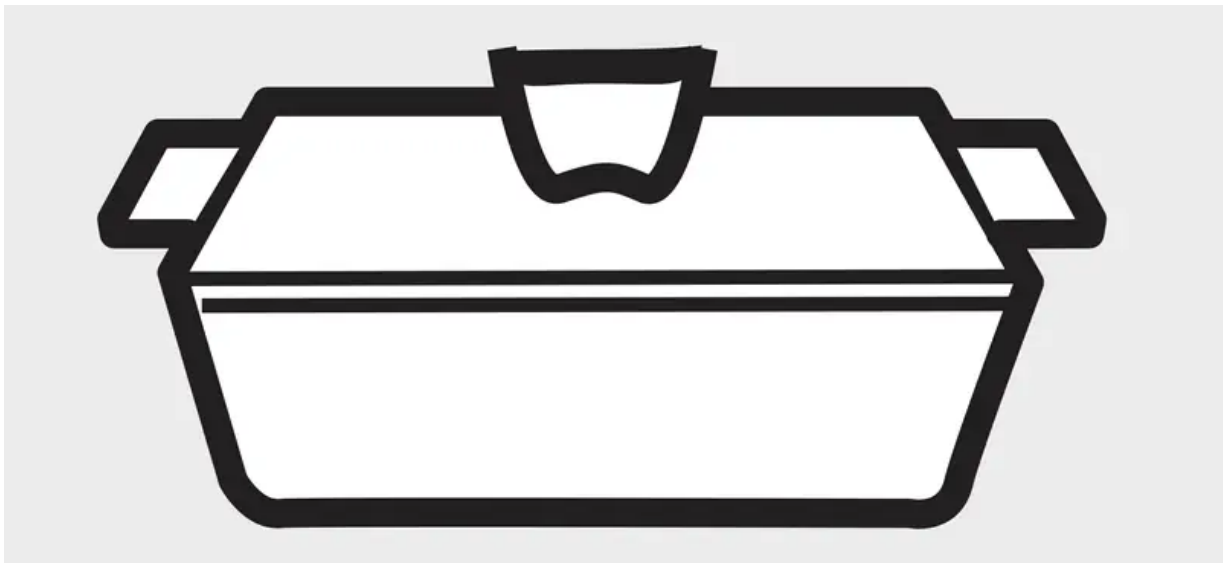

Covered

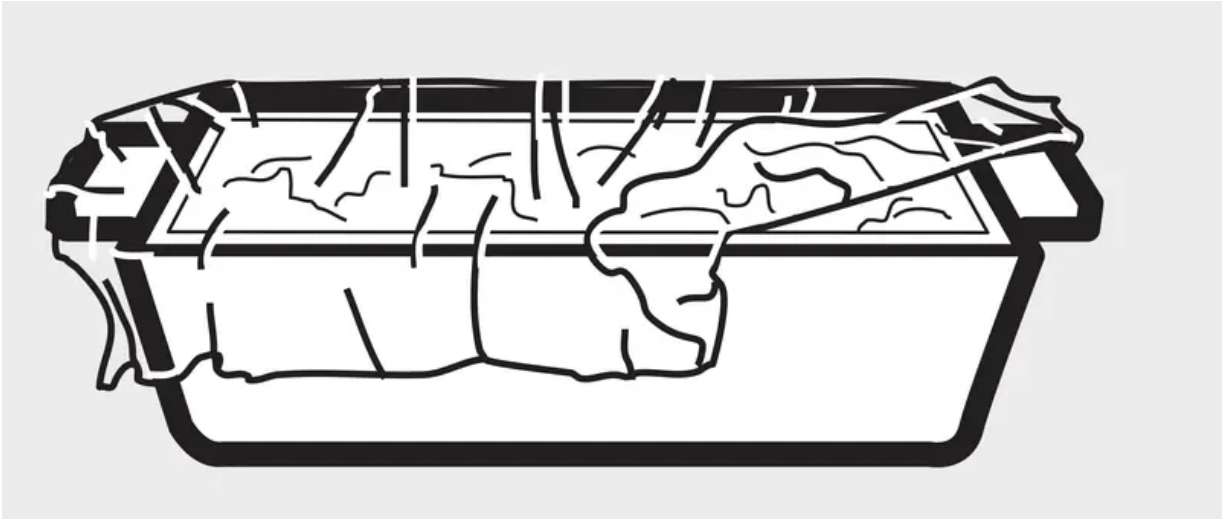

Vented



Dry off dishes so they don't mislead the sensor

**Microwave terms**

Term	Definition
Arcing	<p>Arcing is the microwave term for sparks in the oven. Arcing is caused by:</p> <ul style="list-style-type: none"> <li>• metal or foil touching the side of the oven.</li> <li>• foil that is not molded to food (upturned edges act like antennas).</li> <li>• metal such as twist-ties, poultry pins, gold-rimmed dishes.</li> <li>• recycled paper towels containing small metal pieces.</li> </ul>
Covering	<p>Covers hold in moisture, allow for more even heating and reduce cooking time. Venting plastic wrap or covering with wax paper allows excess steam to escape.</p>
Shielding	<p>In a regular oven, you shield chicken breasts or baked foods to prevent over-browning. When microwaving, you use small strips of foil to shield thin parts, such as the tips of wings and legs on poultry, which would cook before larger parts.</p>
Standing Time	<p>When you cook with regular ovens, foods such as roasts or cakes are allowed to stand to finish cooking or to set. Standing time is especially important in microwave cooking. Note that a microwaved cake is not placed on a cooling rack.</p>
Venting	<p>After covering a dish with plastic wrap, you vent the plastic wrap by turning back one corner so excess steam can escape.</p>

## Changing the Power Level

Cook

Power  
Level

*Express Cook*

1 2 3  
4 5 6

7 8 9

0

Start  
Pause



The power level may be entered or changed after entering the time for Time Cook.

1. Press TIME COOK button once.
2. Enter cooking time.
3. Enter POWER LEVEL when prompted.
4. Press START.

Variable power levels add flexibility to microwave cooking. The power levels on the microwave oven can be compared to the surface units on a range. Each power level gives you microwave energy a certain percent of the time. Power level 7 is microwave energy 70% of the time. Power level 3 is energy 30% of the time. Most cooking will be done on High (power level 10) which gives you 100% power. Power level 10 will cook faster but food may need more frequent stirring, rotating or turning over. A lower setting will cook more evenly and need less stirring or rotating of the food. Some foods may have better flavor, texture or appearance if one of the lower settings is used. Use a lower power level when cooking foods that have a tendency to boil over, such as scalloped potatoes.

Rest periods (when the microwave energy cycles off) give time for the food to "equalize" or transfer heat to the inside of the food. An example of this is shown with power level 3-the defrost cycle. If microwave energy did not cycle off, the outside of the food would cook before the inside was defrosted.

Here are some examples of uses for various power levels:

**High 10:** Fish, bacon, vegetables, boiling liquids.

**Med-High 7:** Gentle cooking of meat and poultry; baking casseroles and reheating.

**Medium 5:** Slow cooking and tenderizing for stews and less tender cuts of meat.

**Low 2 or 3:** Defrosting; simmering; delicate sauces.

**Warm 1:** Keeping food warm; softening butter.

**NOTE:** You can also change the power level during many cooking modes by pressing the power level button entering a valid power level.

## About the other feature

### Cooking Complete Reminder

To remind you that you have food in the oven, the oven will display YOUR FOOD IS READY and beep once a minute until you either open the oven door or press the CANCEL/OFF button.

### Clock

# Settings

Press the Settings button to enter the time of day.

1. Press the Settings button two times.
2. Enter the appropriate time of day.
3. Press Settings to select AM or PM.
4. Press Settings to accept the time.

**Start/Pause**

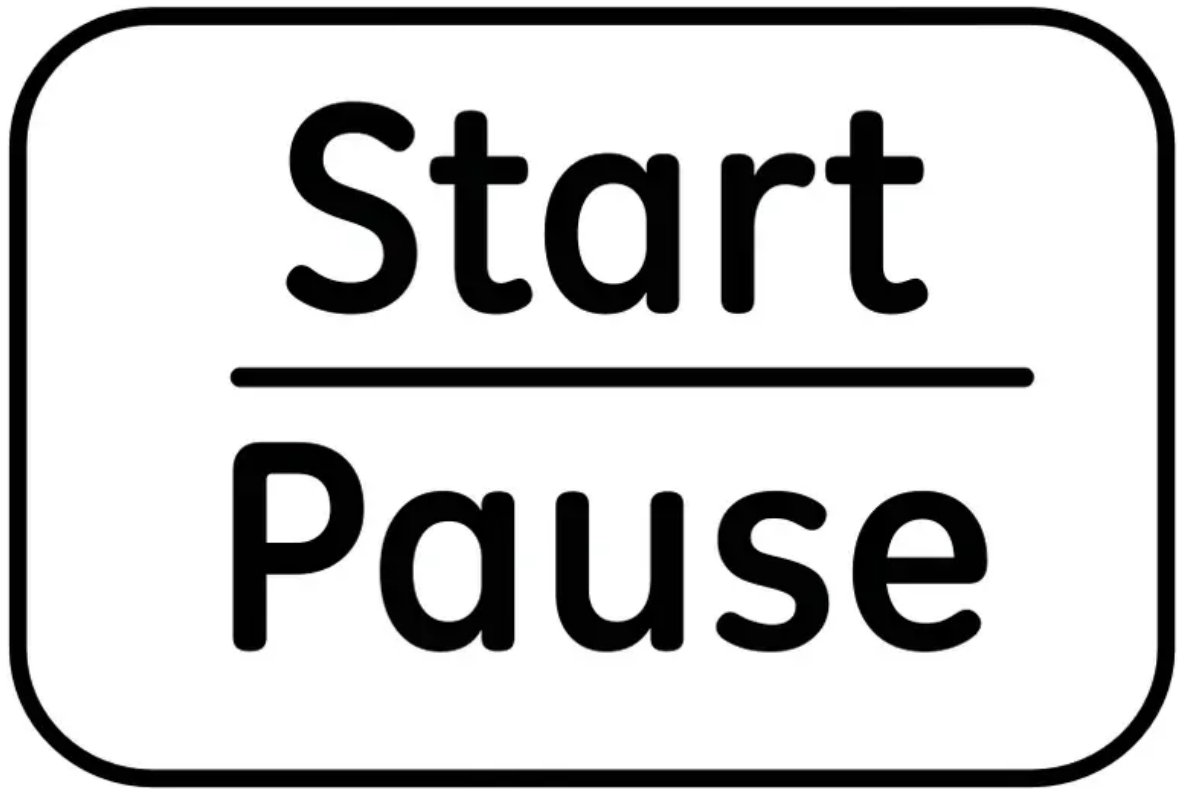

In addition to starting many functions, START/PAUSE allows you to stop cooking without opening the door or clearing the display.

**Cancel/Off**

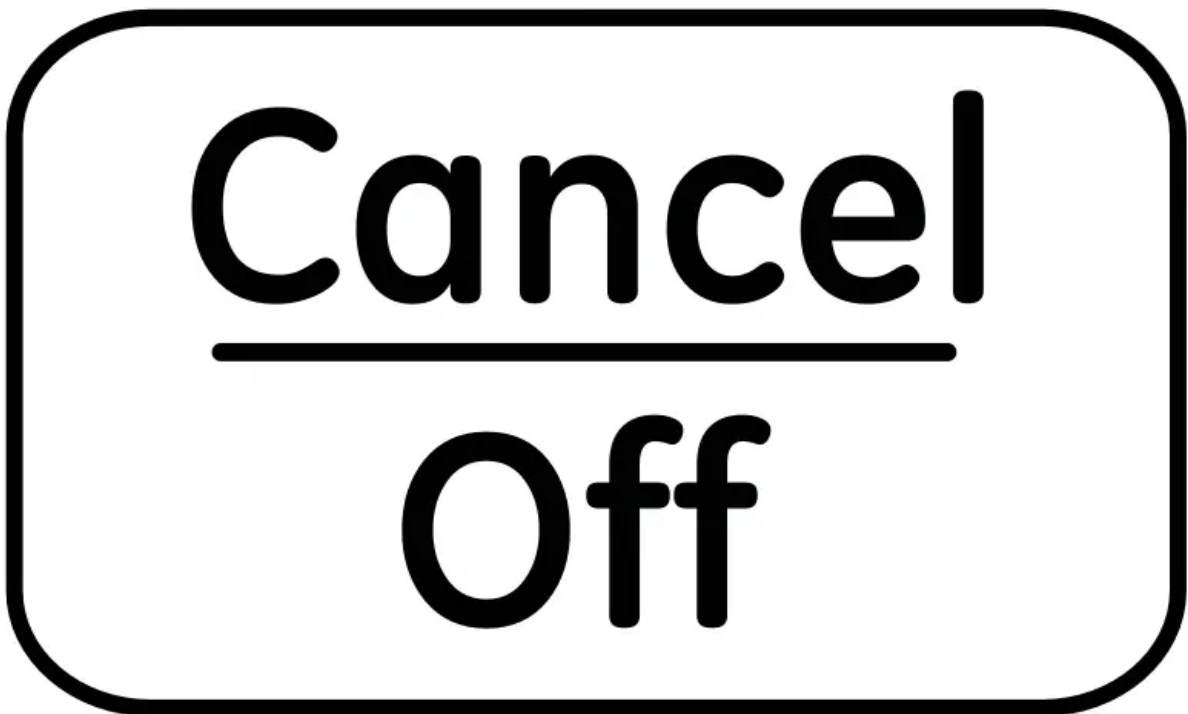

Press the CANCEL/OFF button to stop and cancel cooking at any time.

**Control Lock-Out**

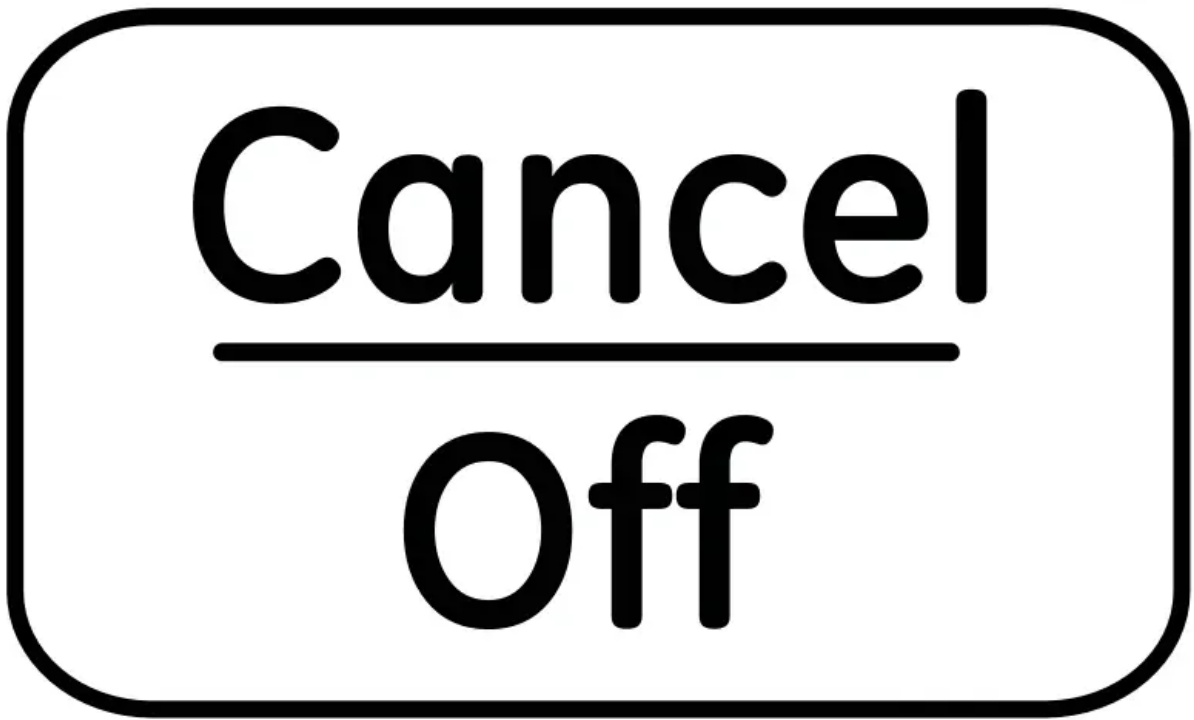

You may lock the control panel to prevent the oven from being accidentally started during cleaning or being used by children.

To lock or unlock the controls, press and hold the CANCEL/OFF button for about three seconds. When the control panel is locked, CONTROL LOCKED will be displayed briefly anytime a button or dial is pressed.

#### **Surface Light**

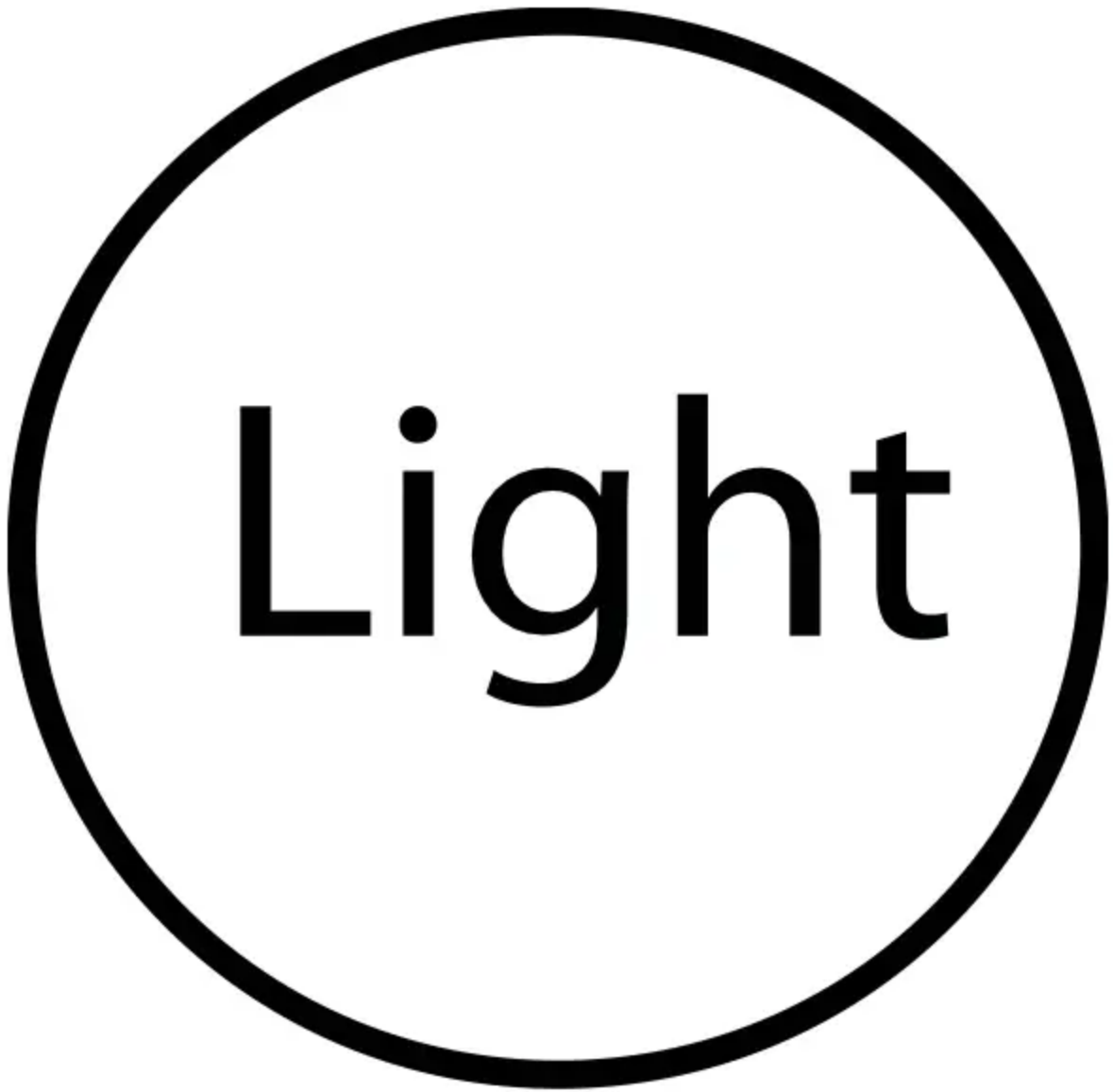

Press SURFACE LIGHT once for bright light, twice for the night light or a third time to turn the light off.

**Timer**

# Timer

The Timer operates as a minute timer and can be used at any time, even when the oven is operating.

1. Press the TIMER on/off button.
2. Enter a time.
3. Press the TIMER on/off button to start.

To cancel, press the TIMER on/off button.

When time is up, the oven will signal.

To turn off the timer signal, press TIMER on/off.

**NOTE:** The TIMER indicator will be lit while the timer is operating.

## **Turntable On/Off**

# Settings

For best cooking results, leave the turntable on. It can be turned off for large dishes.

1. Press the Settings button three times.
2. Select ON or OFF as prompted.

Sometimes the turntable can become too hot to touch.

Be careful touching the turntable during and after cooking.

Some cooking modes do not allow the turntable to be turned off.

## **Beeper Volume**

# Settings

Use to set the beeper volume level.

1. Press the Settings button five times.
2. Press O for mute, press 1 for low, press 2 for normal and press 3 for loud.

**Display Speed**

# Settings

The scroll speed of the display can be changed.

1. Press the Settings button six times.
2. Press:
  - 1 for Slowest
  - 2 for Slow
  - 3 for Normal
  - 4 for Fast
  - 5 for Fastest

### Vent Fan

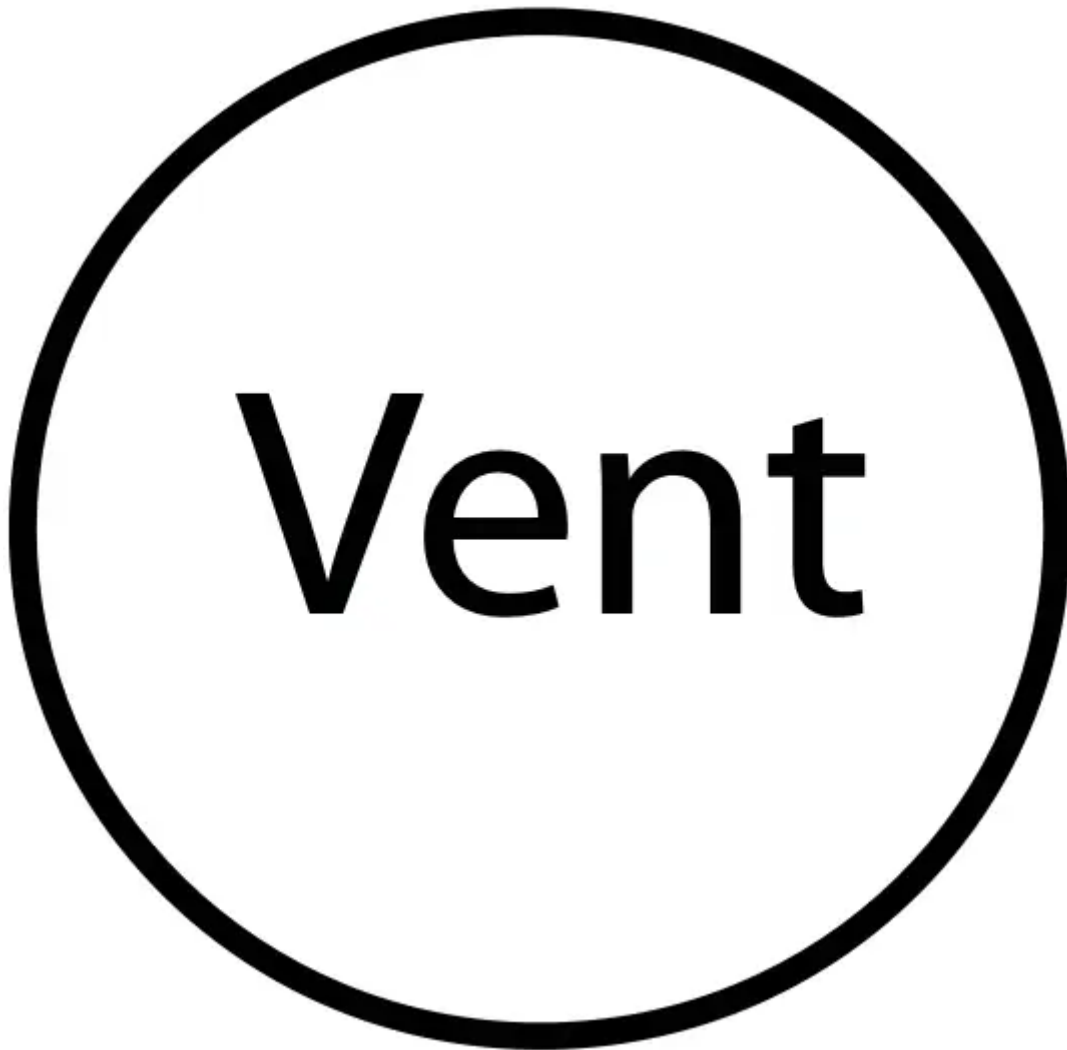

The vent fan removes steam and other vapors from surface cooking.

Press VENT FAN once for boost fan speed, twice for high fan speed, three times for medium fan speed, four times for low fan speed or five time to turn the fan off.

**NOTE:** The FAN indicator will be lit while the fan is operating.

### Automatic Fan

An automatic fan feature protects the microwave from too much heat rising from the cooktop below it. It automatically turns on if it senses too much heat.

If you have turned the fan on you may find that you cannot turn it off. The fan will automatically turn off when the internal parts are cool. It may stay on for 30 minutes or more after the cooktop and microwave controls are turned off.

### Auto Nite Light



The Auto Nite Light can be set to come on and go off at desired times.

1. Press the Settings button four times.
2. Press 0 to turn off the Auto Night Light or press 1 to set the Auto Night Light or press 2 to review the Auto Night Light settings.
3. If setting Auto Night Light, enter a valid time of day for the Auto Night Light to turn ON.
4. Select AM or PM for ON time.
5. Enter a valid time of day for the AutoNight Light to turn it OFF.
6. Select AM or PM for OFF time.
7. Press Settings to confirm the settings entered.

**NOTE:** Auto Night Light will not come on when Power Saver (Energy Saver) button is engaged. Auto nite light will always activate the light to the night setting at the programmed on time, even if the light is already set to the bright setting. Auto nite light will always turn the light off at the programmed off time, even if you have turned the light to bright.

### Display Language

# Settings

Use to select to displayed language.

1. Press the Settings button seven times.
2. Press 1 for English and press 2 for Spanish..

## Care and cleaning of the oven

### Helpful Hints



An occasional thorough wiping with a solution of baking soda and water keeps the inside fresh.

Be sure the power is off before cleaning any part of this oven.

### How to Clean the Inside

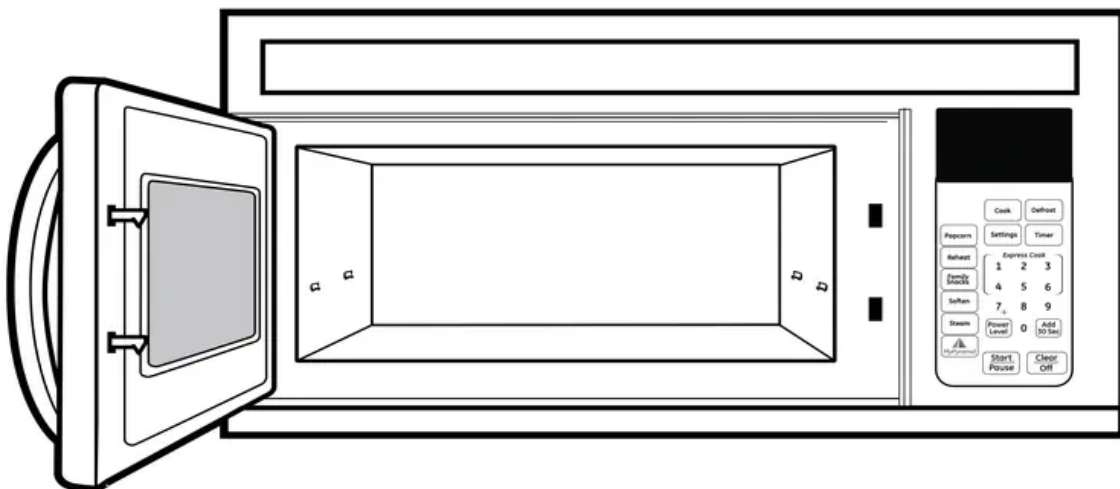

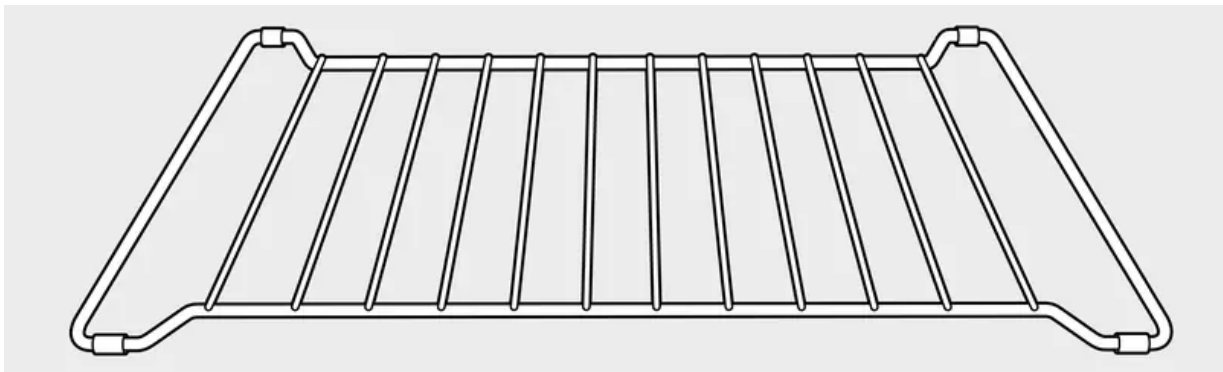
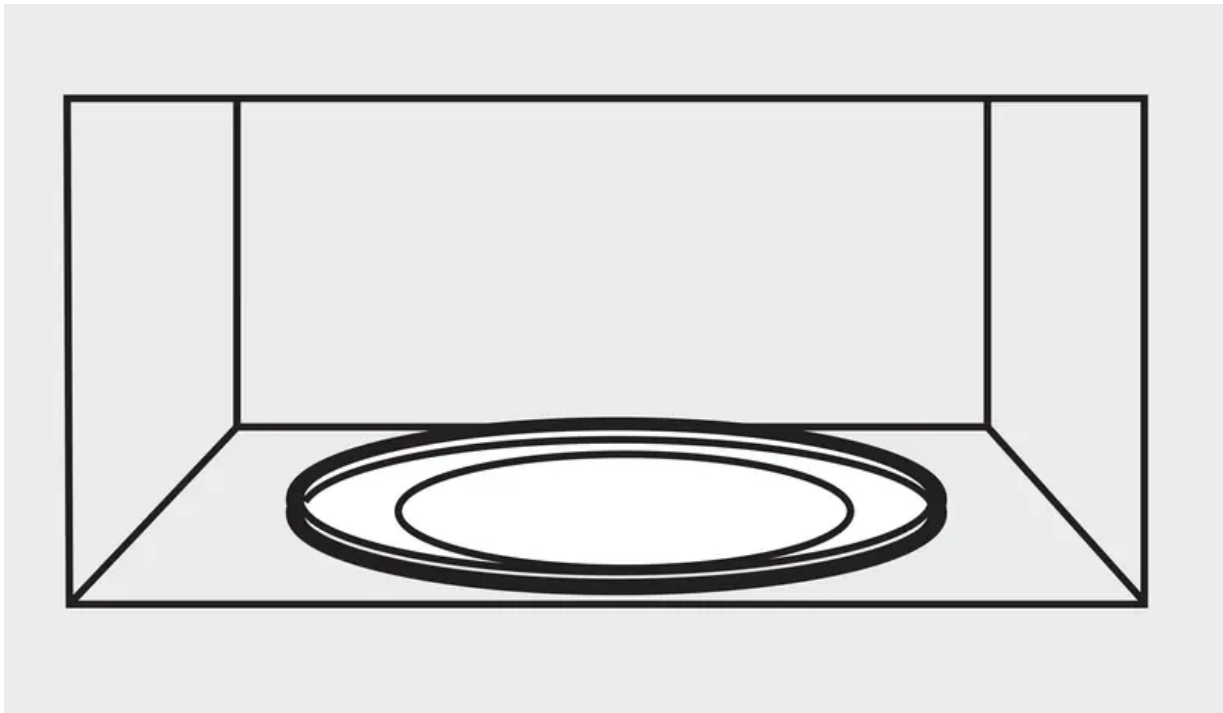

### **Walls, Floor, Inside Window, Metal and Plastic Parts on the Door**

Some spatters can be removed with a paper towel; others may require a damp cloth. Remove greasy spatters with a sudsy cloth, then rinse with a damp cloth. Do not use abrasive cleaners or sharp utensils on oven walls.

Never use a commercial oven cleaner on any part of your microwave.

### **Removable Turntable and Turntable Support**

To prevent breakage, do not place the turntable into water just after cooking. Was hit carefully in warm, sudsy water or in the dishwasher. The turntable and support can be broken if dropped. Remember, do not operate the oven in the microwave mode without the turntable and support seated and in place.

### **Shelves**

Clean with mild soap and water or in the dishwasher.

**Do not clean in a self-cleaning oven.**

## How to Clean the Outside

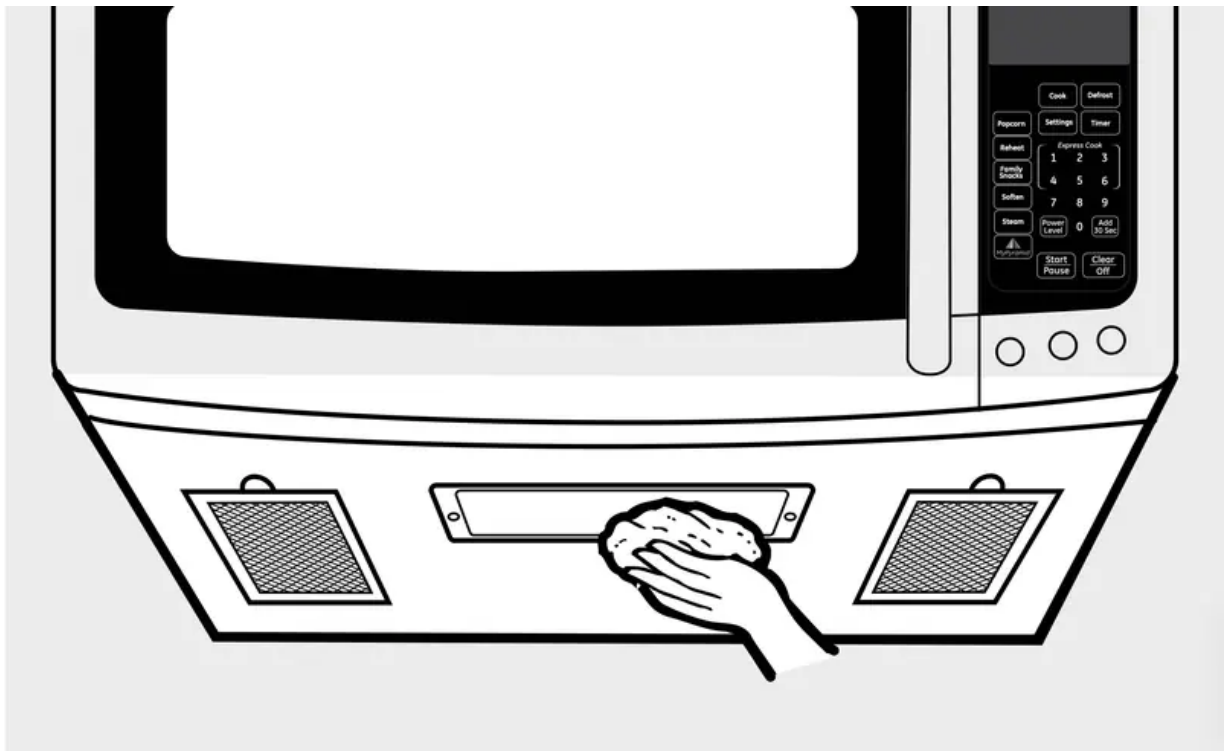
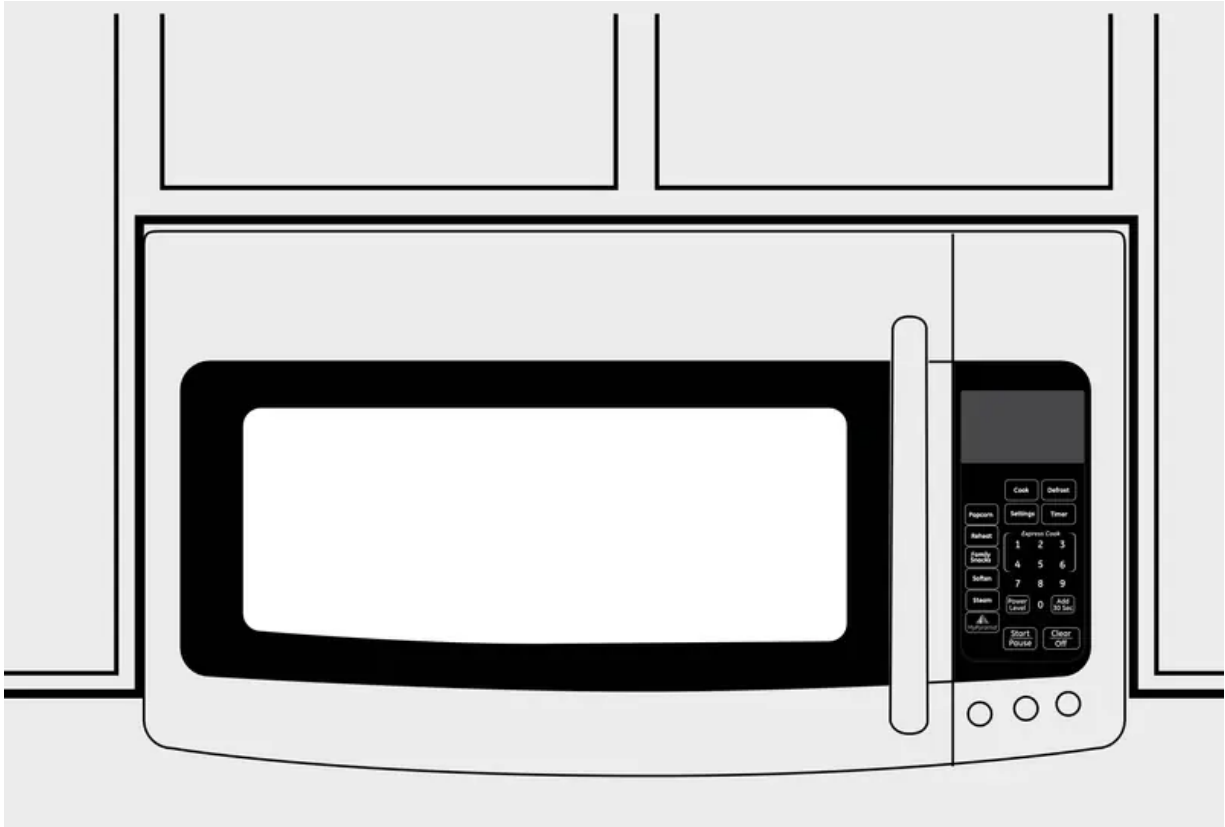

We recommend against using cleaners with ammonia or alcohol, as they can damage the appearance of the microwave oven. If you choose to use a common household cleaner, first apply the cleaner directly to a clean cloth, then wipe the soiled area.

## **Case**

Clean the outside of the microwave with a sudsy cloth. Rinse and then dry. Wipe the window clean with a damp cloth.

## **Control Panel**

Wipe with a damp cloth. Dry thoroughly. Do not use cleaning sprays, large amounts of soap and water, abrasives or sharp objects on the panel—they can damage it. Some paper towels can also scratch the control panel.

## **Door Panel**

Before cleaning the front door panel, make sure you know what type of panel you have. Refer to the eighth digit of the model number. "S" is stainless steel, "L" is Clean Steel and "B", "W" or "C" are plastic colors.

## **Stainless Steel (on some models)**

The stainless steel panel can be cleaned with Stainless Steel Magic or a similar product using a clean, soft cloth. Apply stainless cleaner carefully to avoid the surrounding plastic parts. Do not use appliance wax, polish, bleach or products containing chlorine on Stainless Steel finishes.

## **Plastic Color Panels**

Use a clean, soft, lightly dampened cloth, then dry thoroughly.

## **Door Seal**

It's important to keep the area clean where the door seals against the microwave. Use only mild, non-abrasive detergents applied with a clean sponge or soft cloth. Rinse well.

## **Bottom**

Clean off the grease and dust on the bottom often. Use a solution of warm water and detergent.

## **Shelf (on some models)**

### **Shelf (on some models)**

Only use microwave shelf when reheating on more than one level. DO NOT store the oven shelf in the microwave.

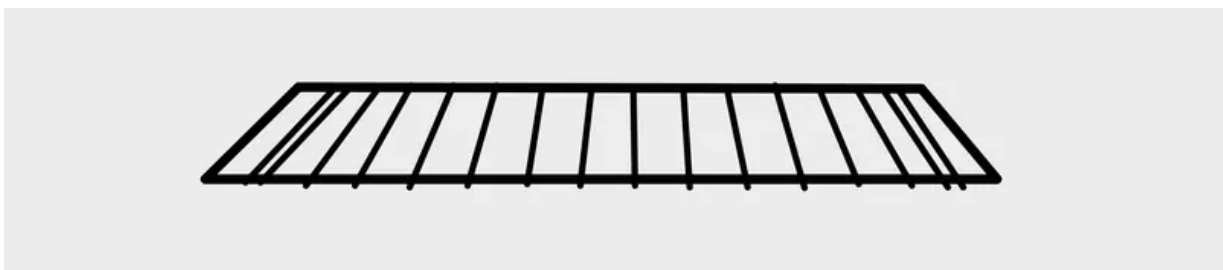

### ***How to Use the Shelf When Microwaving:***

- Make sure the shelf is positioned properly inside the microwave to prevent damage to the oven from arcing.

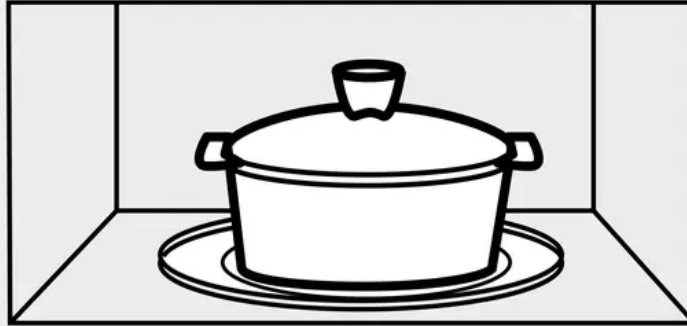

**For best results**

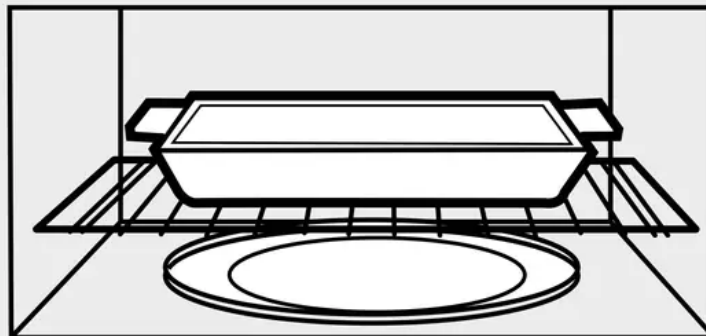

**Uneven results**

- Do not use a microwave browning dish on the shelf. The shelf could overheat.
- Do not use the oven with the shelf on the microwave floor. This could damage the microwave.
- Use pot holders when handling the shelf - it may be hot.
- Do not use the shelf when cooking popcorn.

Food microwaves best when placed on the turntable or on the shelf in the lower position.

Use lower shelf supports when cooking one oblong or oversized dish.

Use the upper shelf supports for two-level cooking.

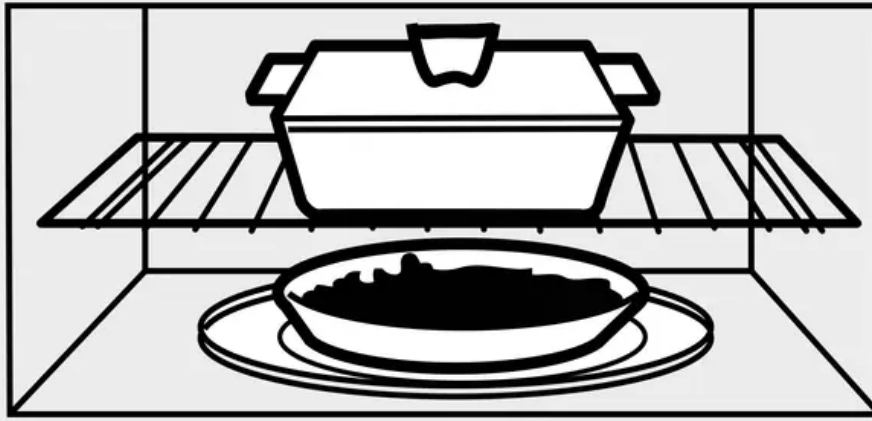

**2-level reheating**

**Shelf and Reheating**

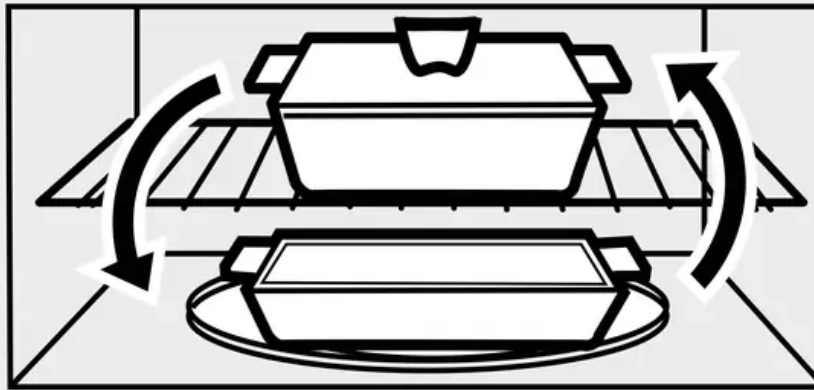

**Switch places after 1/2 time**

**To reheat on 2 levels or**

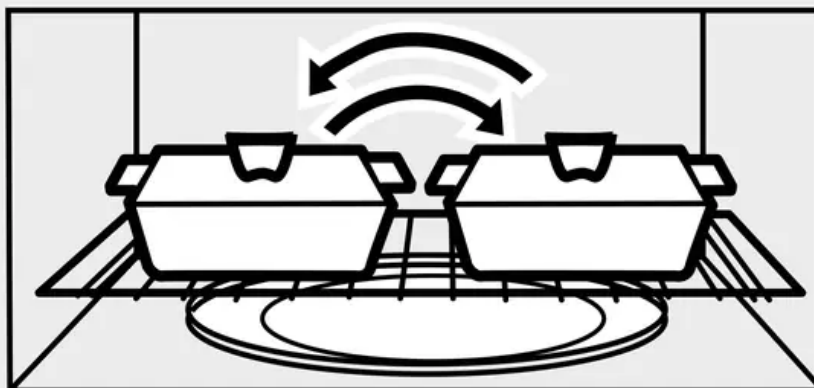

**Switch places after 1/2 time**



**To reheat 2 dishes on the lower level:**

1. Multiply reheat time by  $1\frac{1}{2}$ .
2. Switch places after  $\frac{1}{2}$  the time.

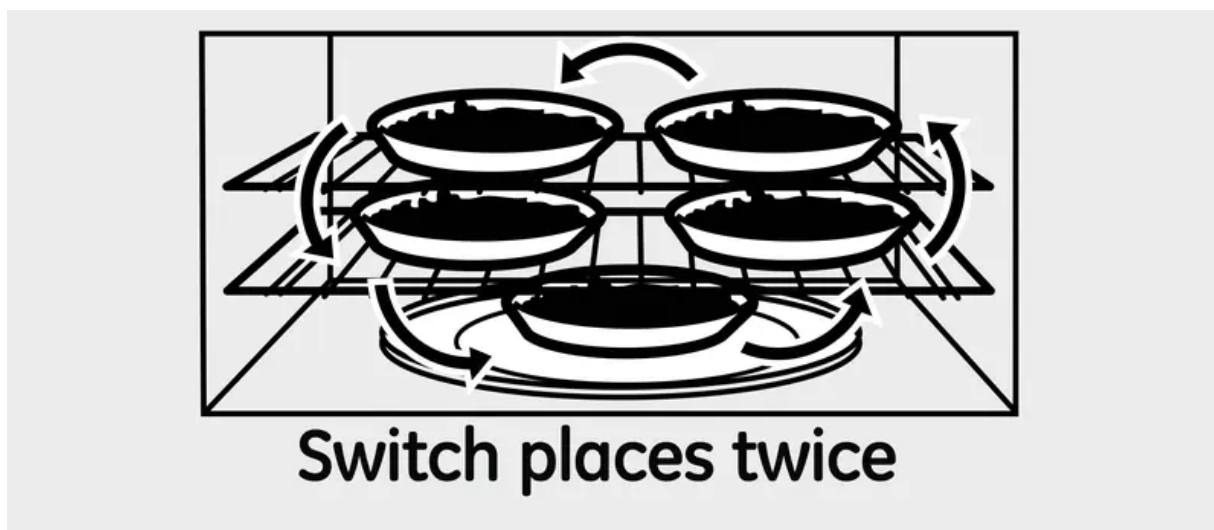

**To reheat on 3 levels (on some models)**

1. Double the reheating time.
2. Switch places twice and give the dishes a  $\frac{1}{2}$  turn during reheating. (Place dense foods, or those that require a longer cook time, on the upper shelf first).

**Replacing the light bulb.**

**Cooktop Light/Nite Light**

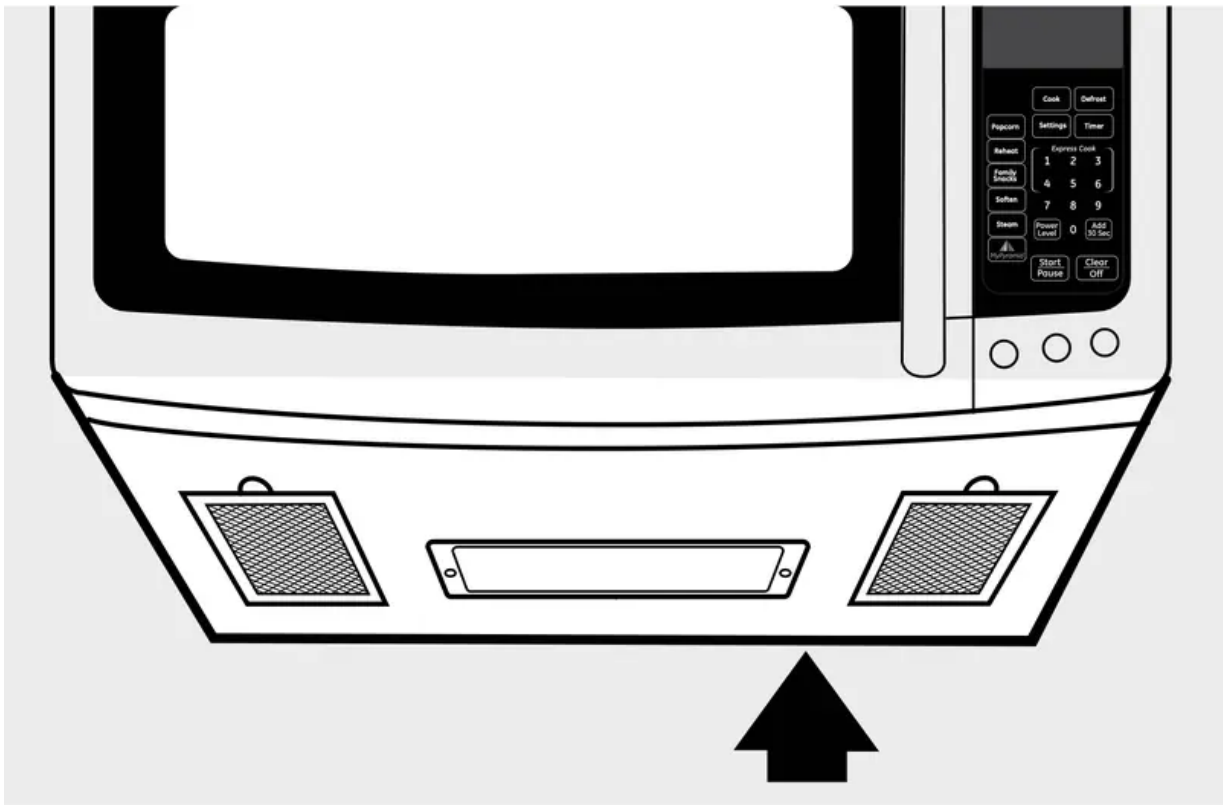

*Remove screw.*

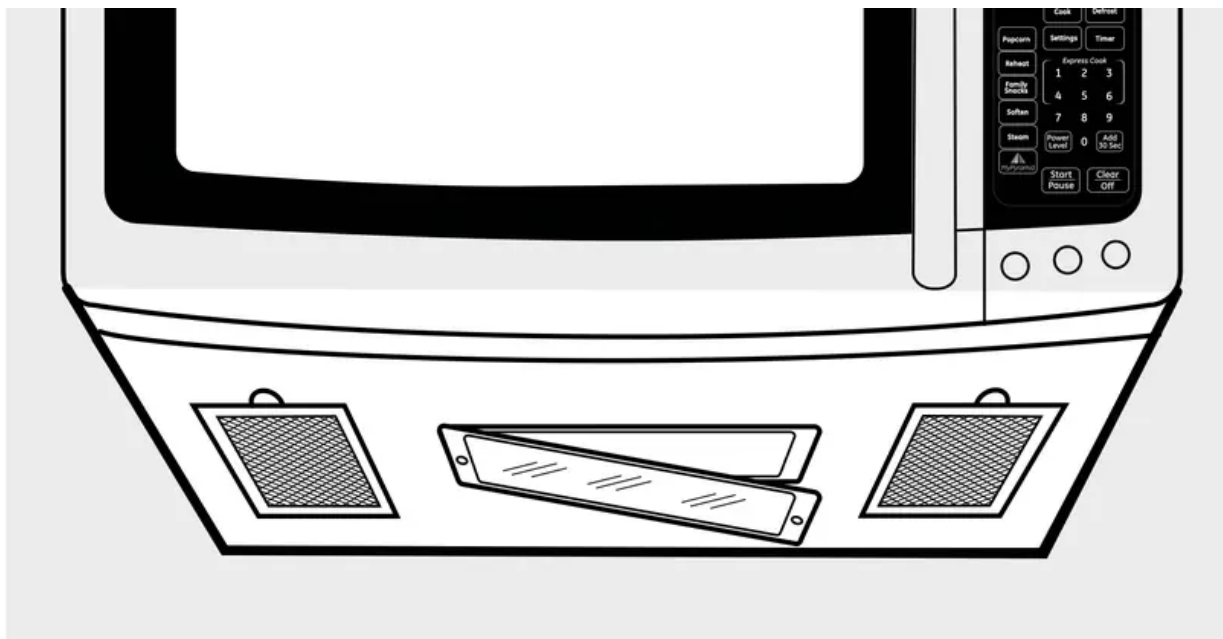

Replace with a 120 volt, 25 or 50 watt (max.) halogen bulb. Order WB08X10051 from your GE supplier.

1. To replace the cooktop light/nite light, first disconnect the power at the main fuse or circuit breaker panel, or pull the plug.
2. Remove the screw from the side of the light compartment cover and lower the cover until it stops.

3. Be sure the bulb is cool before removing. Break the adhesive seal by gently unscrewing the bulb.
4. Screw in the new bulb, then raise the light cover and replace the screw. Connect electrical power to the oven.

### About the exhaust feature.

#### Vent Fan

*Charcoal filter (on some models).*

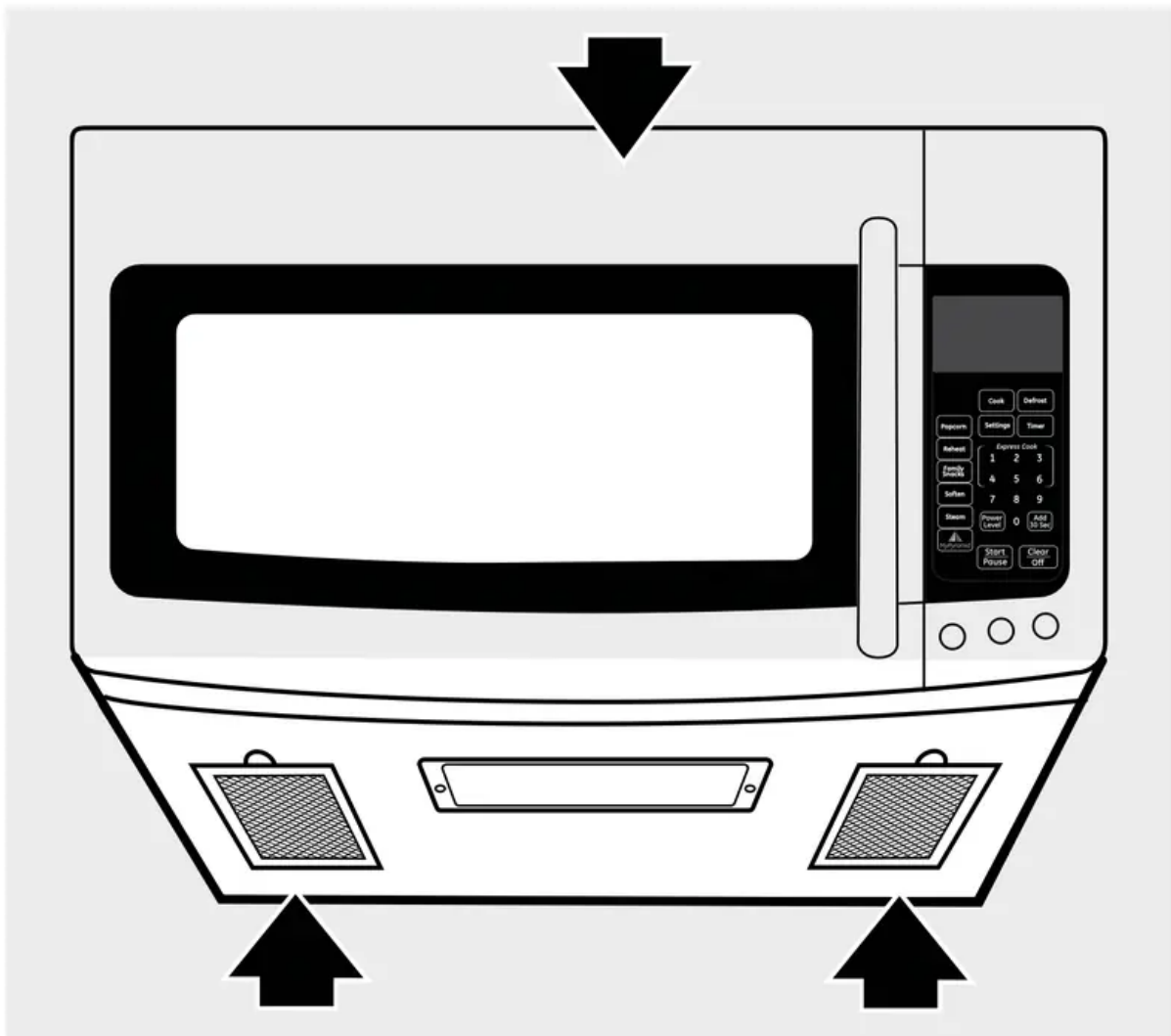

*Reusable vent filters  
(on all models).*

The vent fan has two metal reusable vent filters.

Models that recirculate air back into the room also use a charcoal filter.

### Reusable Vent Filters

The metal filters trap grease released by foods on the cooktop. They also prevent flames from foods on the cooktop from damaging the inside of the oven.

For this reason, the filters must always be in place when the hood is used. The vent filters should be cleaned once a month, or as needed.

### Removing and Cleaning the Filters

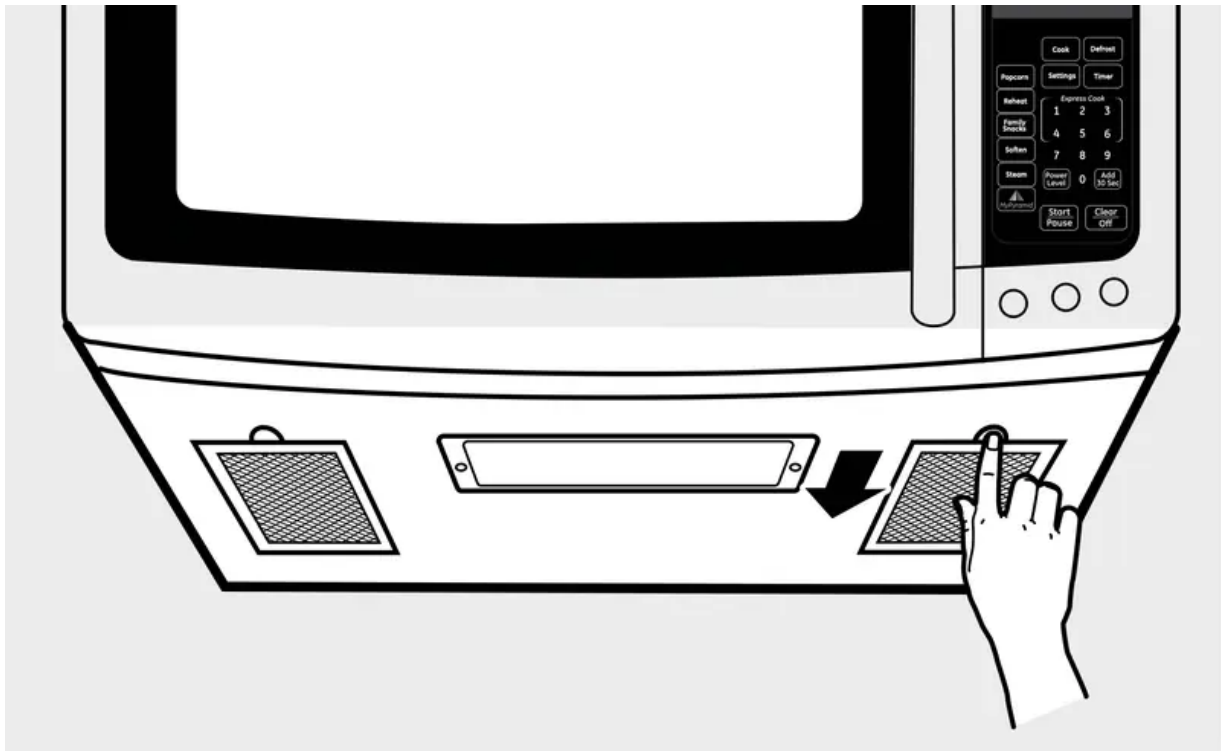

To remove, slide them to the rear using the tabs. Pull down and out.

To clean the vent filters, soak them and then swish around in hot water and detergent. Don't use ammonia or ammonia products because they will darken the metal. Light brushing can be used to remove embedded dirt.

Rinse, shake and let dry before replacing.

To replace, slide the filters into the frame slots on the back of each opening. Press up and to the front to lock into place.

### Charcoal Filter

The charcoal filter cannot be cleaned. It must be replaced. Order Part No. WB02X10943 from your GE supplier.

If the model is not vented to the outside, the air will be recirculated through a disposable charcoal filter that helps remove smoke and odors.

The charcoal filter should be replaced when it is noticeably dirty or discolored (usually after 6 to 12 months, depending on usage). See "Optional Kits," page 8, for more information.

### To Remove the Charcoal Filter

To remove the charcoal filter, first disconnect power at the main fuse or circuit breaker, or pull the plug. Remove the top grille by removing the two screws that hold it in place.

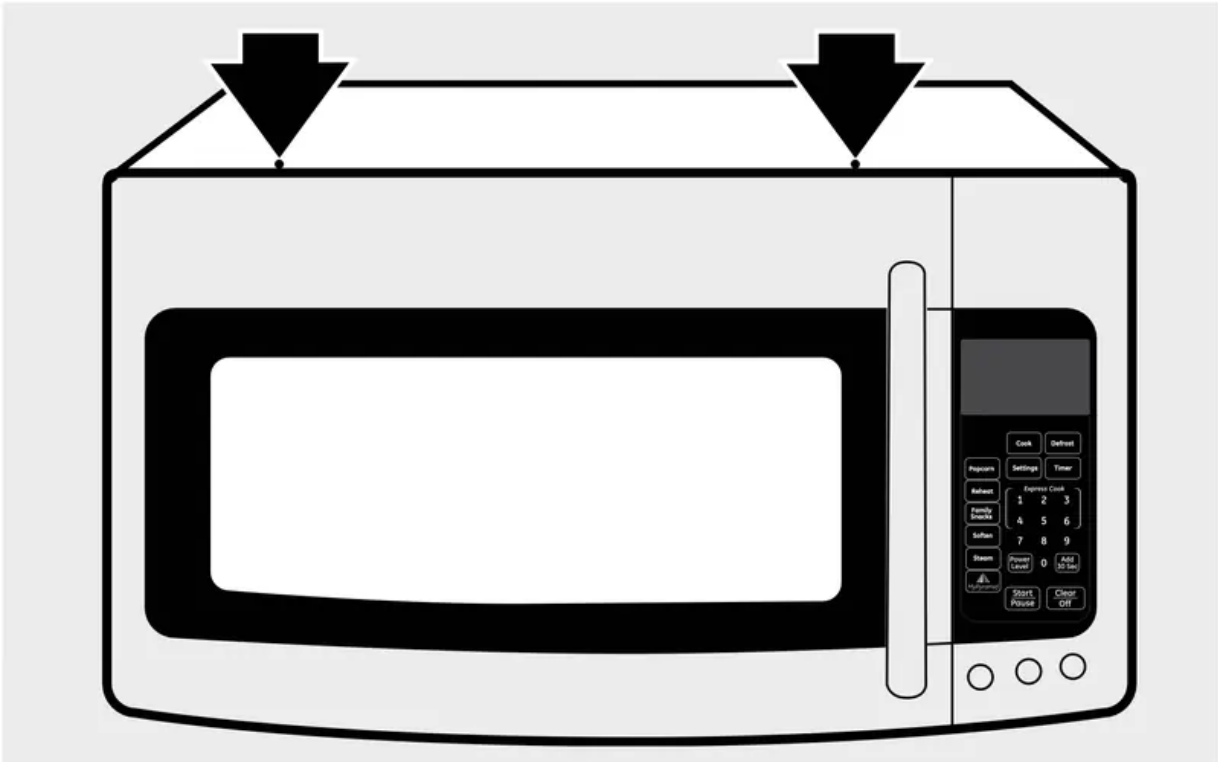

Remove 2 grille screws to remove the grille.

You may need to open the cabinet doors to remove the screws.

Lift the filter at the bottom until it comes free of the tabs. Slide the filter down and out.

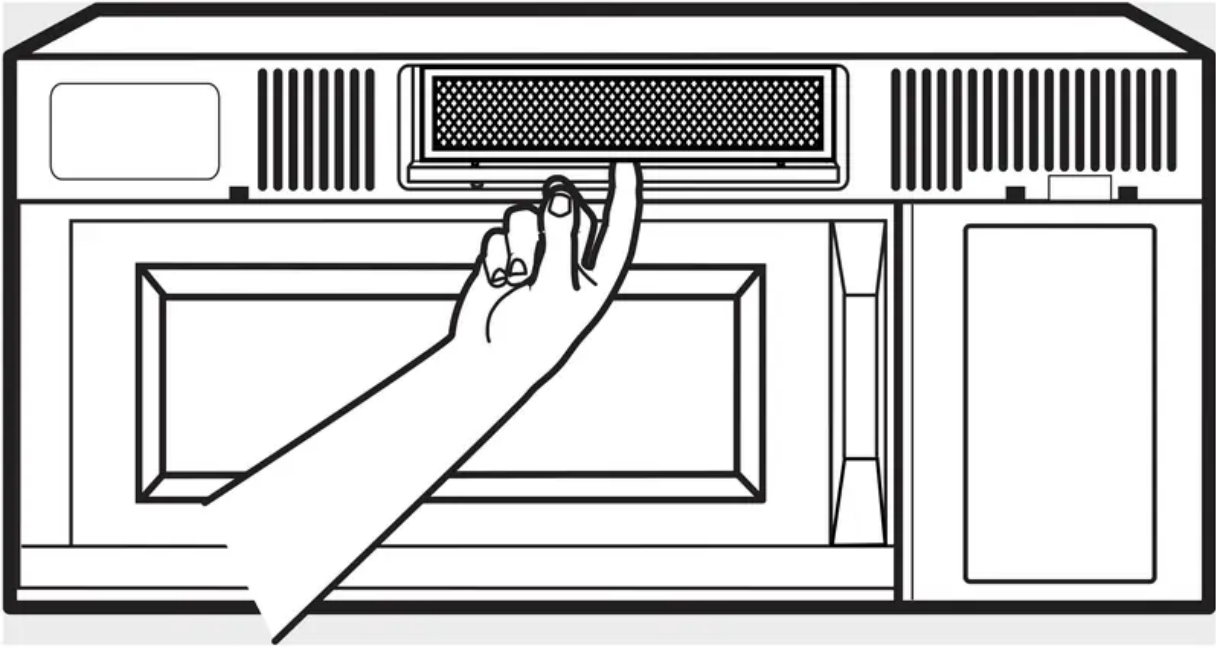

### To Install the Charcoal Filter

To install a new charcoal filter, remove plastic and other outer wrapping from the new filter.

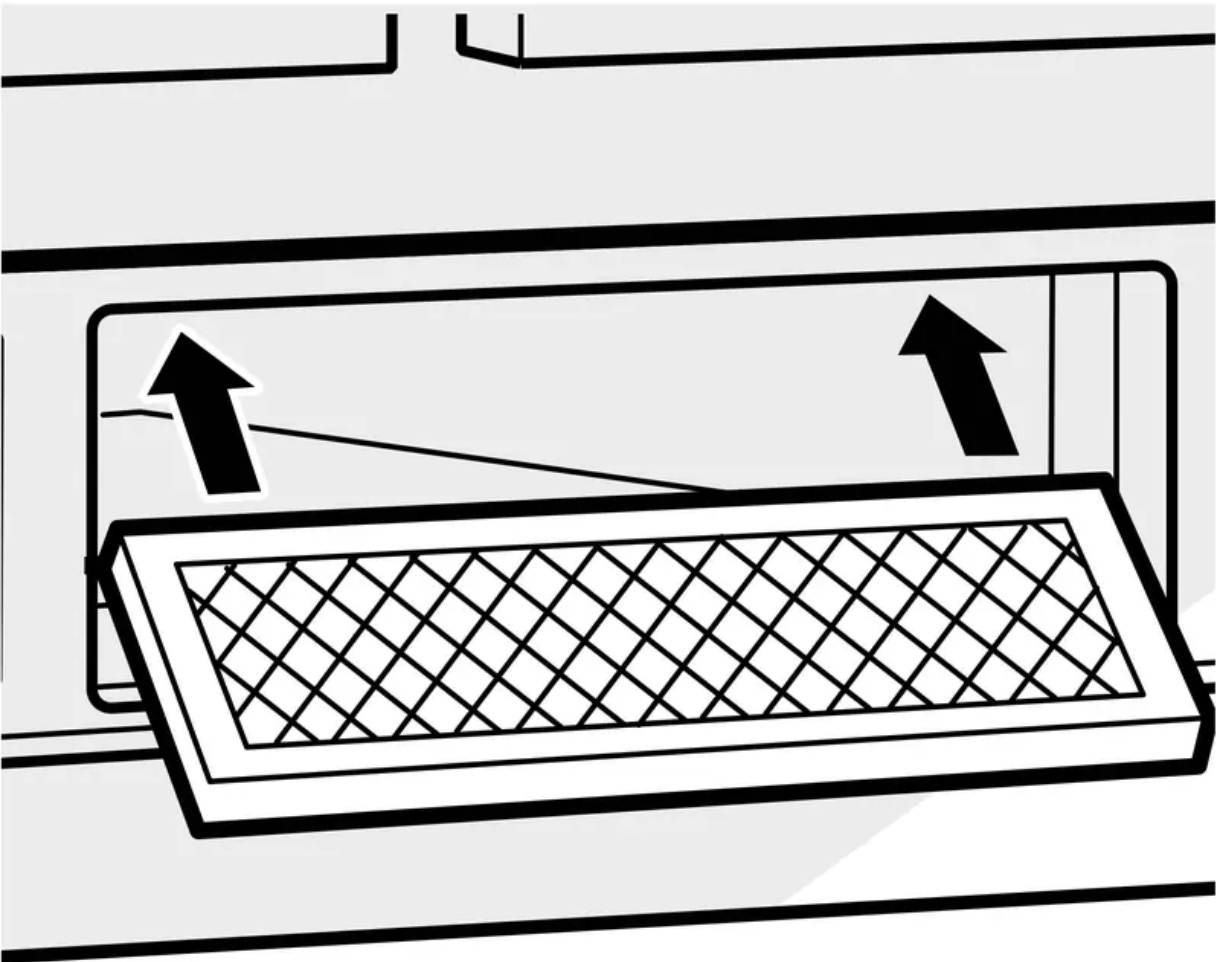

Insert the top of the filter up and into the grooves on the inside of the top opening. Push the bottom of the filter in until it rests in place behind the tabs.

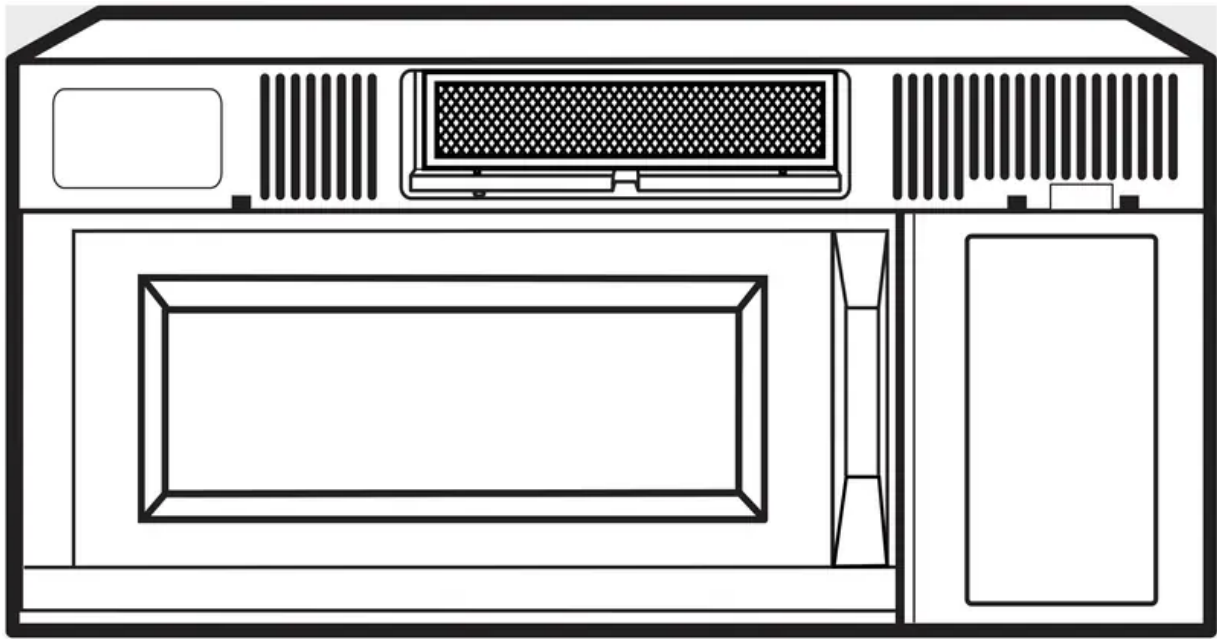

## Troubleshooting

### Before you call for service...

#### Things That Are Normal With Your Microwave Oven

- Moisture on the oven door and walls while cooking. Wipe the moisture off with a paper towel or soft cloth.
- Moisture between the oven door panels when cooking certain foods. Moisture should dissipate shortly after cooking is finished.
- Steam or vapor escaping from around the door.
- Light reflection around door or outer case.
- Dimming oven light and change in the blower sound at power levels other than high.
- Dull thumping sound while oven is operating.
- TV/radio interference might be noticed while using the microwave. Similar to the interference caused by other small appliances, it does not indicate a problem with the microwave. Plug the microwave into a different electrical circuit, move the radio or TV as far away from the microwave as possible, or check the position and signal of the TV/ radio antenna.

**Warning**

This content is compiled from multiple sources and is provided for reference purposes only. It may not be complete or fully applicable to all situations. If you are unable to resolve your issue, please contact the product manufacturer or an authorized service provider for official support.

---

Document generated by [ManualsFile](#)