

How to Use the Operation Panel

Touching  will cause the operable icons to light up.

To save power, all displays other than  are usually turned off (it turns off if there is no operation for about 30 seconds).

When operating, be sure to touch the buttons with your fingers.



ECO GUIDE

The refrigerator's ECO level is indicated with the number of  marks. Page 20

Detail Setting

Touch  to go to compartment selection.

Touch  to go to various settings. Page 21-25.

Example: When setting the refrigerator compartment to "M"



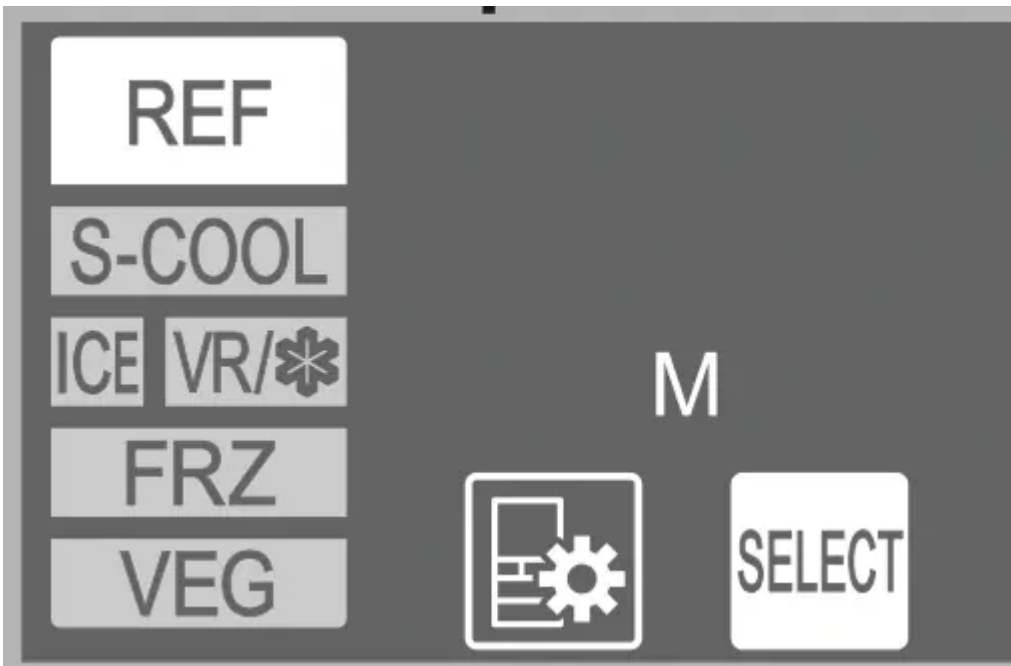

When setting or cancelling settings (or cancelling in the middle), touch one of these.

Touch an icon to display its setting details.



If you touch the operation panel, icons will be displayed. You can select the setting that you prefer.



Energy Saving Mode

To successfully save power



Supercool Chilling

To preserve meat or fish below freezing



Supercool Freezing

To supercool freeze foods such as meat, fish, and dessert





Hot Freezing

To use Supercool Freezing on hot cooked foods such as freshly cooked rice, curry, and sauces

Beginning Use

- **The refrigerator takes time to cool complet**
 - Wait until the refrigerator has sufficiently cooled before storing ice cream and foods cooler than room temperature.
 - Do not open the doors more than necessary, and close them as soon as possible.
 - In summertime, it may take more than 24 hours to make ice immediately after installation.
- **There may be a plastic odor.**
 - This odor will gradually disappear.
Ventilate the room to prevent any odors from being trapped.
- **The refrigerator will be powerfully cooled (this is the same for summertime).**
 - Because heat will radiate out of the refrigerator in order to cool its contents, the sides will become hot.
 - Because the compressor will enter high-speed operation, the operation sound will grow loud.

Operation Example (When Setting Supercool Chilling)

1.  **Touch**
When you keep the door of the refrigerator open, touch for about 1 second. (until the buzzer sounds once).
2. **Touch the icon to set**
Here touch .
3. **Confirm the setting details and compartment, then touch** .

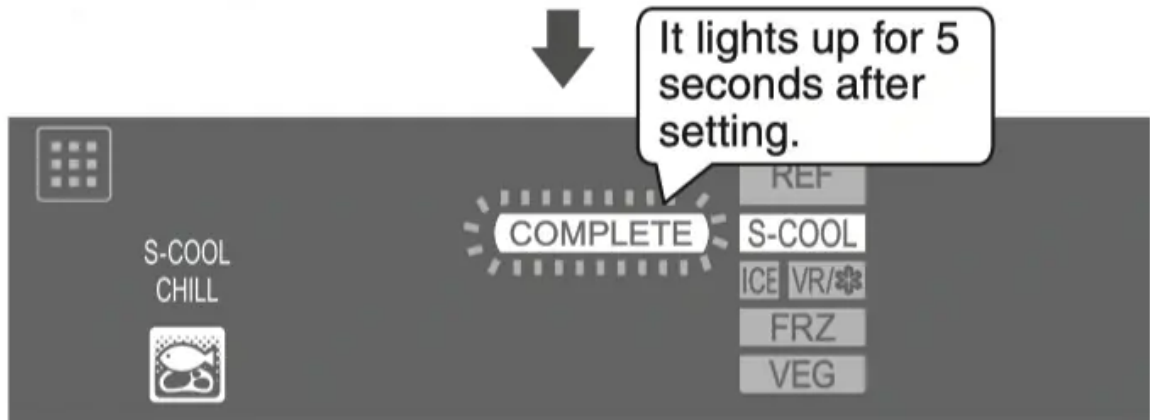
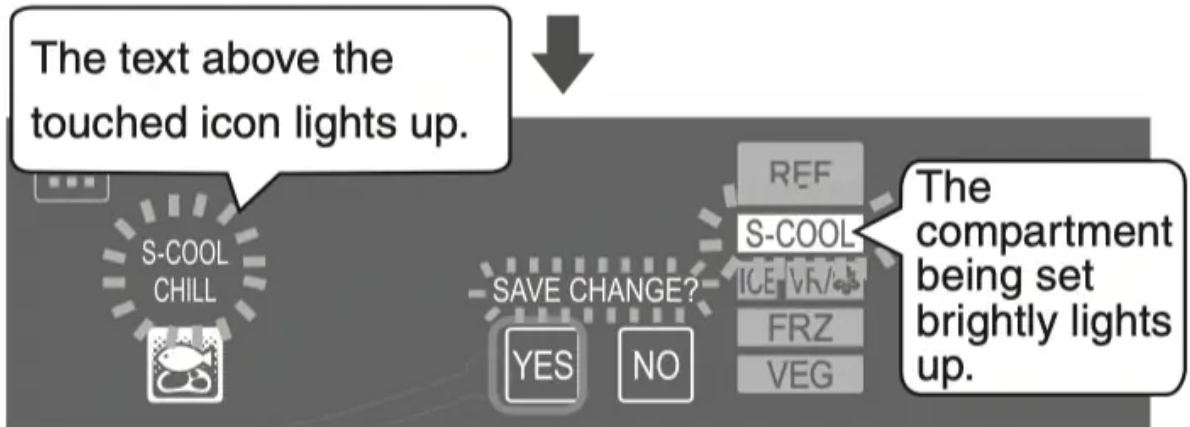
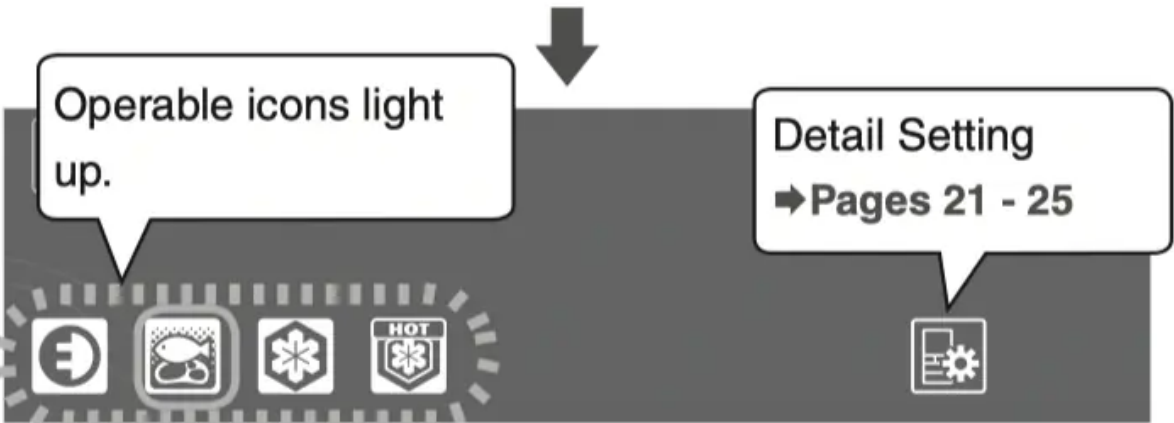



In 2 and 3 , touching returns the display to the previous state.

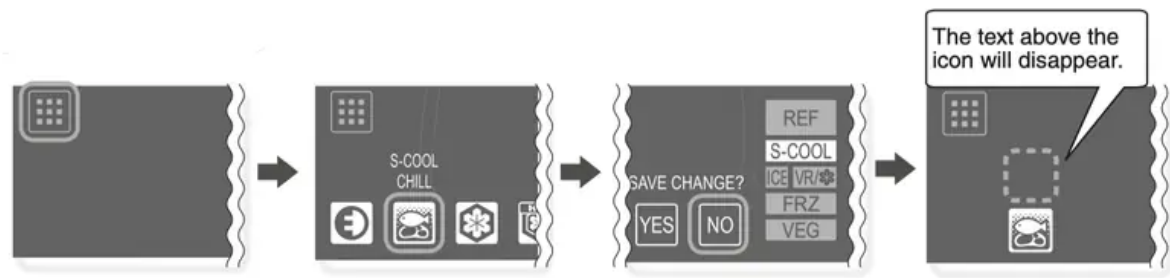

To Cancel the Setting/Cancel in the Middle



1. Touch  .
2. Touch the icon to cancel.
3. Touch  .

In the following cases, the display may not change even when you touch it.

The operation panel or your fingers are wet or dirty.



You are wearing gloves or have sticking plaster on your finger.

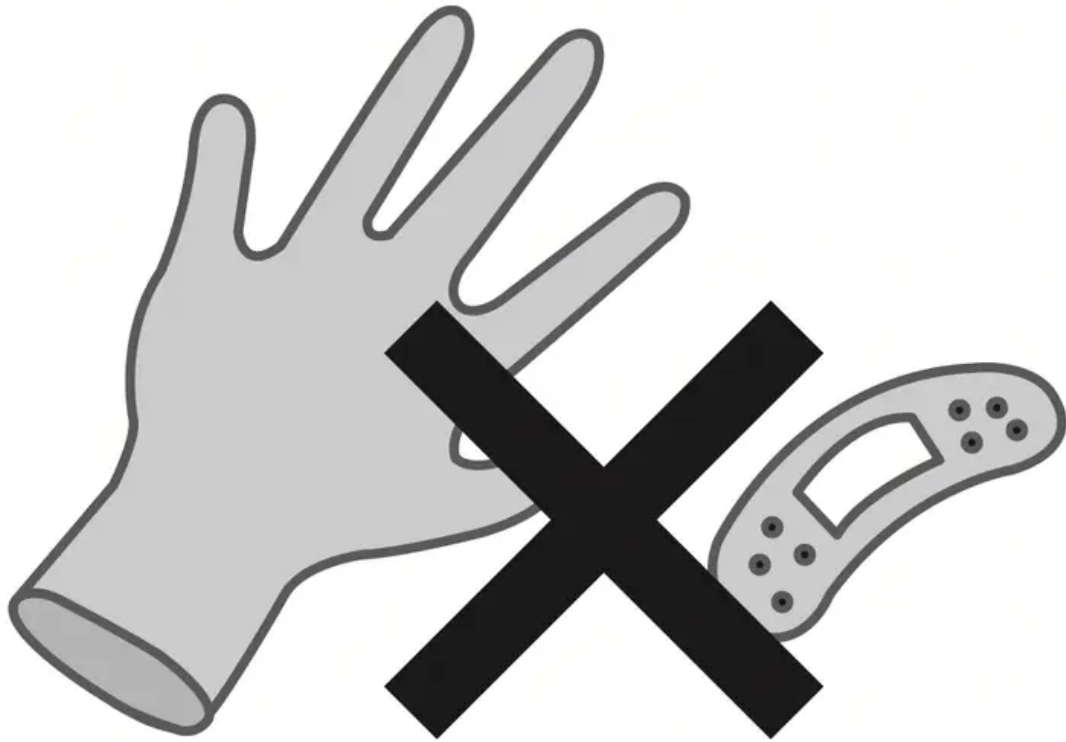

The interval between touches is too short. (Pressing repeatedly may cause a misdetection)

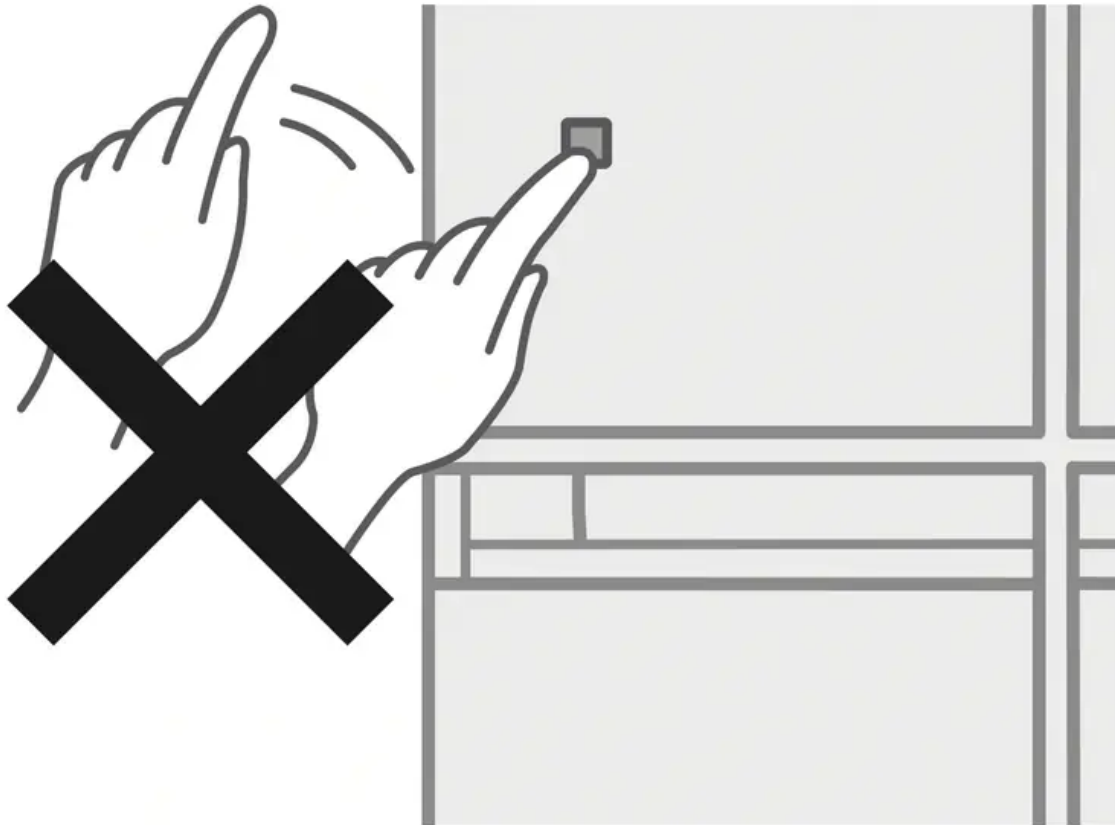

- Wipe the moisture and dirt off your fingers.
Perform operations with your hands. After you have touched an icon, confirm that the display has changed before touching again.
- The response may vary, depending on the surrounding temperature, humidity, the health condition of the person who operates it, and the operating condition of neighboring electric appliances.

Refrigerator Compartment / Sliding Cases

Use the refrigerator compartment when storing foods that will be consumed soon. Foods such as meat, fish, dairy products, and processed food can be kept fresh longer in the sliding cases at a temperature lower than the refrigerator compartment.

Refrigerator Compartment About 0°C to 6°C

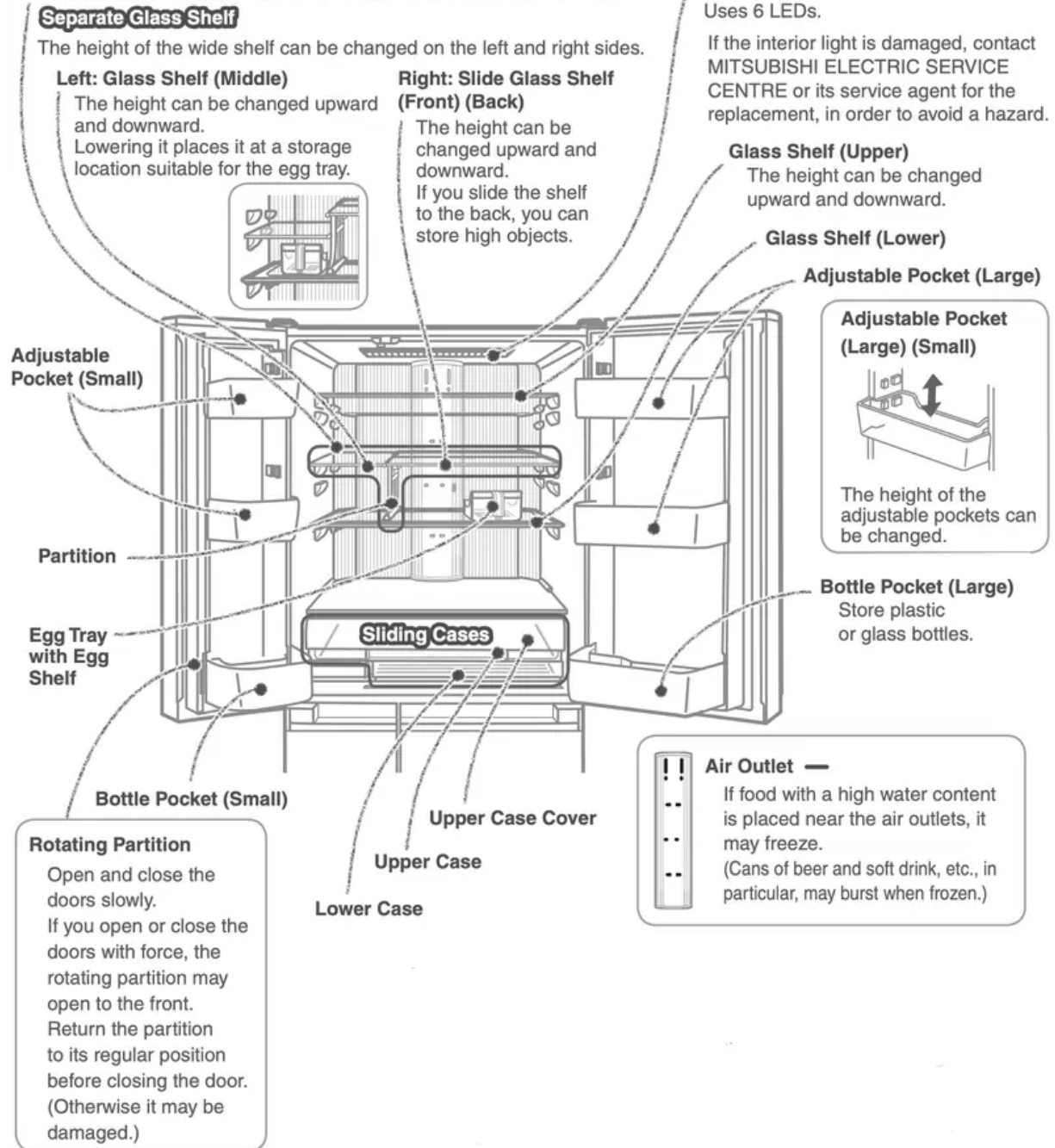

Preventing the Transfer of Odors

It is recommended that foods that have strong odors or easily absorb odor are either wrapped thoroughly or stored in an airtight container.

Kimchi, pot stickers, sardines (seafood), beef, etc. Food that transfers odors easily

Rice, potato salad, etc. Food that may easily absorb odors

The door will automatically close from halfway with the Auto closer

With the door of the refrigerator compartment open at an angle of about 20 degrees or less, the door will close automatically.

The door may stop before closing completely if you swing the door too softly.

If the door stops (ajar), it will not close automatically.

The speed of the closing door may change according to the amount of food stored.

Sliding Cases About -3°C to 3°C

At the time of purchase, the lower case is not set to Supercool Chilling.

When setting Supercool Chilling, use the following settings.

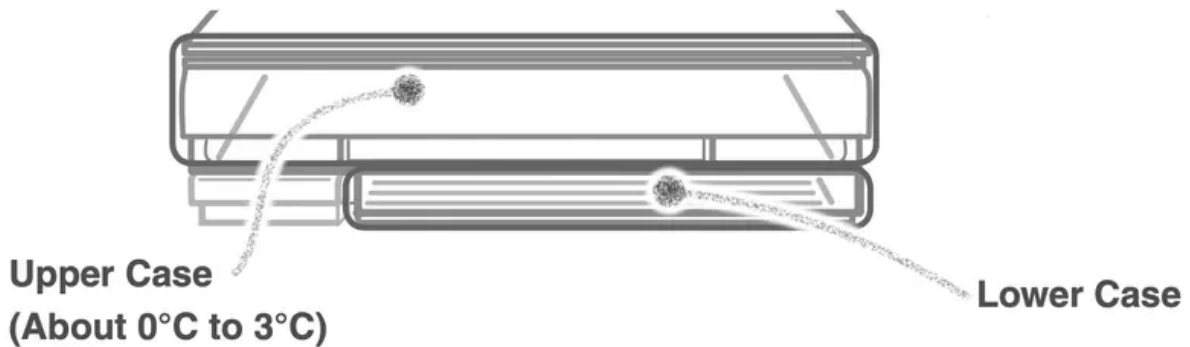

Upper Case (About 0°C to 3°C)

- Processed food such as sausage, ham and dairy products can be preserved.
- Do not store food that is easily frozen.
- The temperature cannot be adjusted.

Lower Case Supercool Chilling can be set with .

- Food will not freeze, even below the freezing point (about -3°C to 0°C)
- The freshness of meat and fish can be prolonged without freezing.

Preserving Meat or Fish Below Freezing

Supercool Chilling

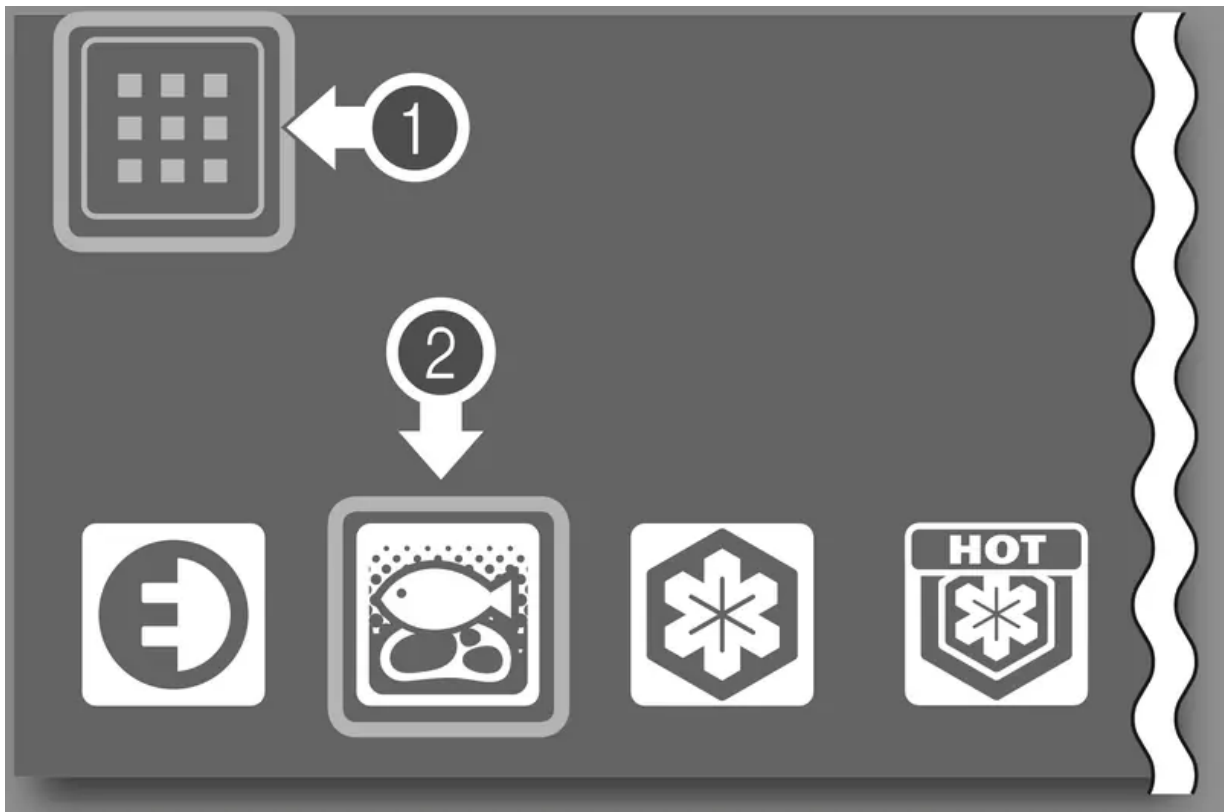

Supercool Chilling stores and preserves meat or fish for a longer time at a temperature lower than the refrigerator compartment or upper case without freezing them.

Once it has been set, Supercool Chilling will be the default setting until it is disabled.

To Set

1. Touch  on the operation panel.

2.



Touch .

The text above the icon will light up.



3.



Touch .

The settings are finished.

It doesn't matter whether you put food before or after the in settings.

To cancel the setting

*If you disable the setting, the lower case can be used in the same way as the upper case.

Supercool Chilling Is Very Useful

- **Tastes good.**

Because the food doesn't freeze, the fresh flavor lasts longer!

- **Keep fresh.**

Meat and fish last longer and are fresher than in the refrigerator compartment or upper case!

Tips

- Do not leave food hanging over shelves or pockets.
- Do not place bottles that cannot fit all the way to the bottom of the bottle pocket.
- Do not attach a case that you purchased separately onto the outside of a pocket.
- Do not heat the glass surfaces of the glass shelves or place hot objects on them.
- Do not close the door while food is in front of the upper case or the lower case.
- Fully stow away the cases. Otherwise they may keep a door ajar and reduce the cooling performance, or food may fall and cause damage to a case.
- Do not pile food to the top. Leave a gap so that cold air can flow to the ceiling and between food.

Notice

- Because sliding cases cannot guarantee the quality of foods that easily freeze (such as tofu, konjac, raw eggs, vegetables, etc.), storing such foods is not suitable. Depending on the type and amount of food, as well as its condition at the time it is placed in the refrigerator, food may freeze.
- The temperature of the lower case (when Supercool Chilling is set) may exceed 0°C depending on the time of door opening/closing and the amount of food.

Ice Making Compartment

If water is put into the refrigerator compartment's water tank, ice will be made in the ice making compartment.

Clean the ice maker periodically to ensure that the ice is pure and delicious.

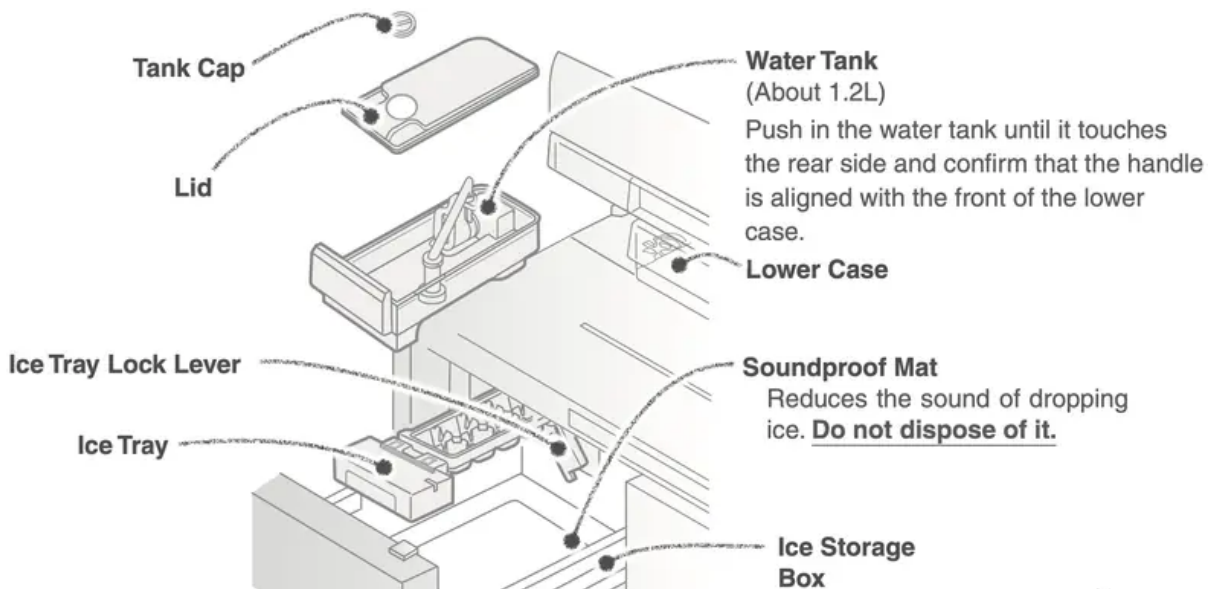

Making Ice

Wash the water tank, water supply pipe, and ice tray before making ice for the first time, or if you have not made ice for more than a week.

1. Remove the water tank from the refrigerator compartment, remove the tank cap by twisting it, and supply water.

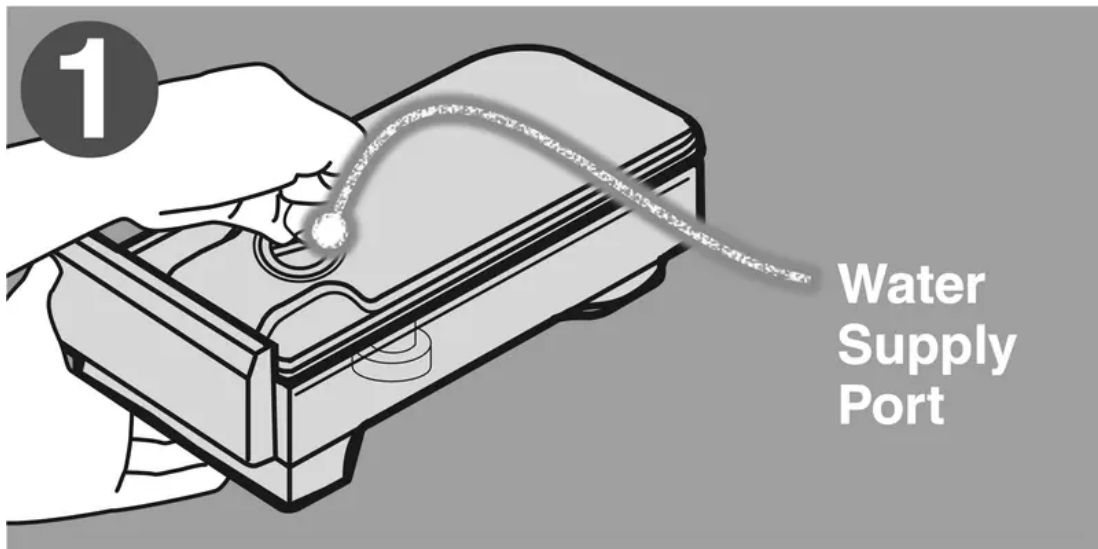

Do not pour water above the full position (▲)

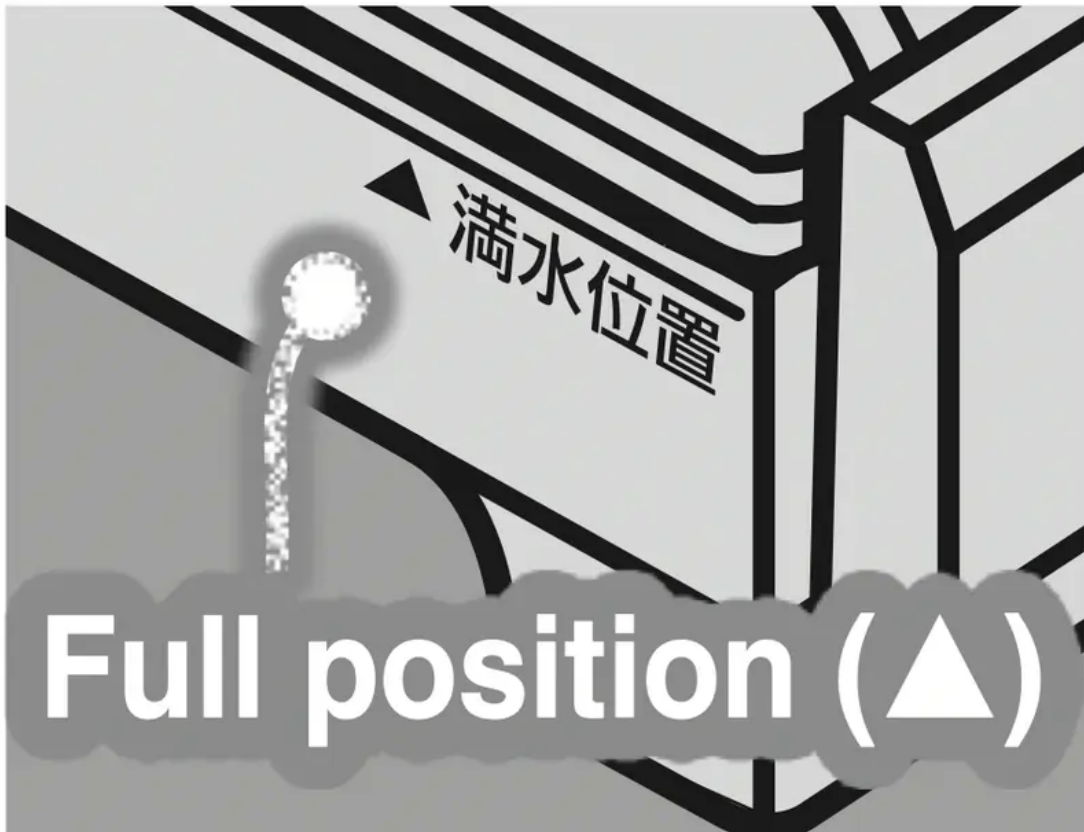

Water will easily spill when you carry the tank. Further, it may cause the ice to join together or form a protrusion.

*WARNING-Fill with potable water only.

2. Close the water tank cap and return the water tank to its original position.

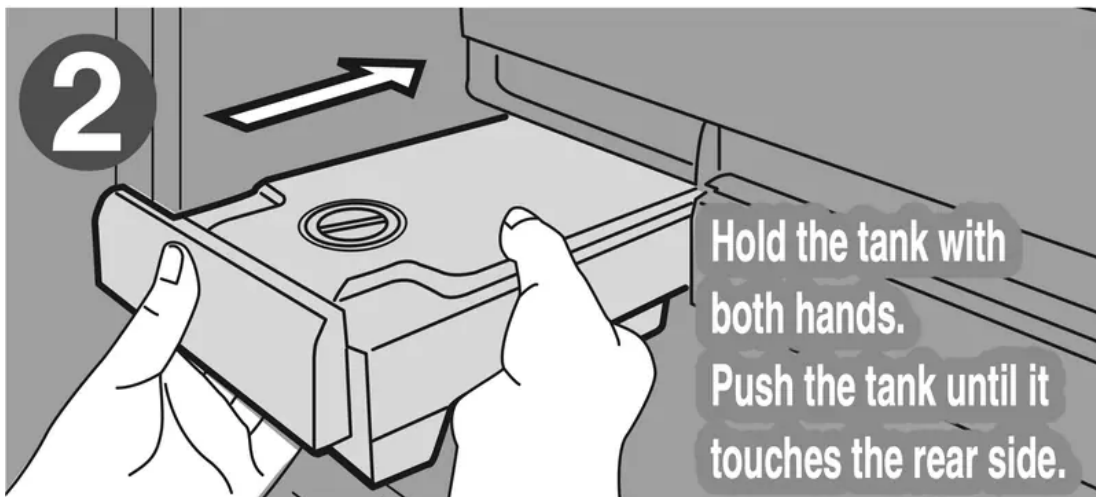

Push in the water tank until it touches the rear side.

Setting the water tank incorrectly may prevent ice from forming.

Tilting the tank will cause the water to spill.

Tips

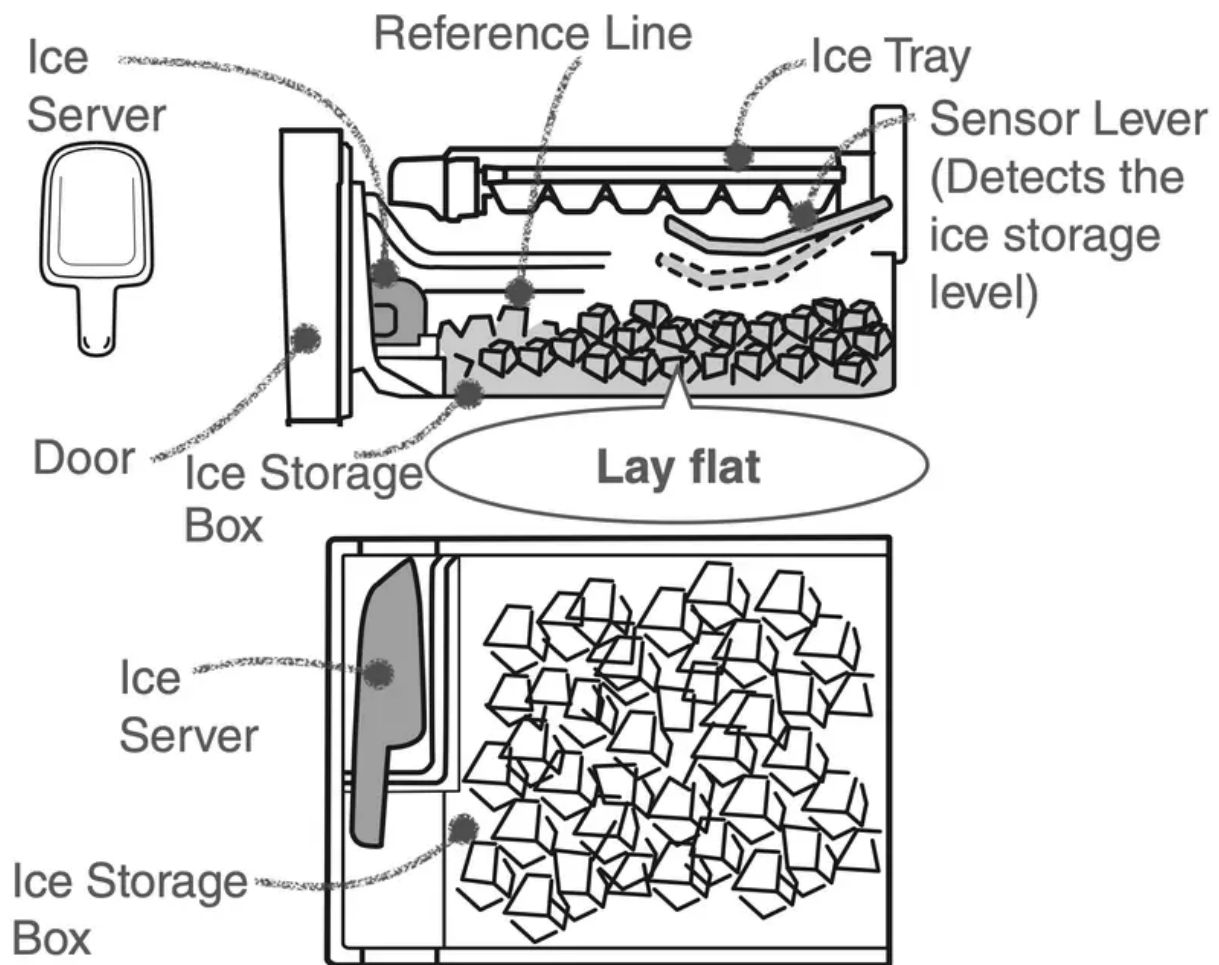



- Do not place food inside when making ice.
- Stop the ice making and then place the food below the reference line on the side. (Not doing so may result in a half-shut door or malfunction and damage)
- Do not pour anything other than cold water into the water tank, such as warm water, juice, tea, soft drinks, or other liquids (the tank can resist heat up to 60°C). Pouring anything other than cold water into the tank may cause damage.
- Do not pour water directly into the ice tray to make ice. Unfrozen water in the ice tray may fall into the ice storage box, and the ice may not form cubes.
- The level of the ice storage is checked automatically by the sensor lever, and ice making is stopped when the ice reaches a certain level (about 70 to 140 ice cubes). To detect the ice storage level correctly, make sure that the ice is flat and that the ice server is kept in its storage position in the front of the ice storage box as shown in the left diagram.
- Open and shut the door of the ice making compartment slowly. There is a risk of the ice spilling.

Quick Ice Making

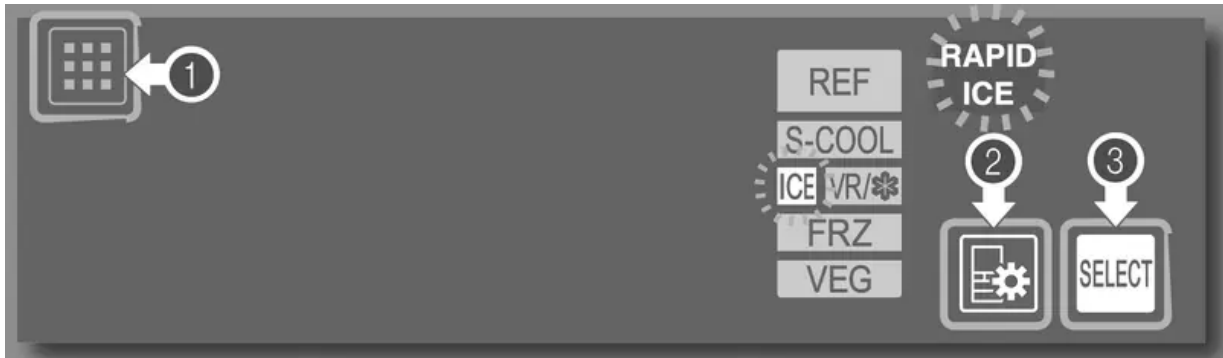

Rapid Ice (Quick Ice Making)

The ice making time for a single batch can be shortened.





1. Touch  on the operation panel.

2. Repeatedly touch  to display 

3. Repeatedly touch  to light up .
The display changes each time the button is touched.



The settings are finished.

- To cancel Rapid Ice, select  or .
- In the following cases, quick ice making is stopped automatically, and regular ice making will begin.
 - When about 10 hours have passed since the quick ice making is set.
 - When the ice storage box is full (about 70 to 140 ice cubes)
 - When there is no water in the water tank
- The sound of the refrigerator running gets louder during Rapid Ice, because it is operating at high speed.
Also, the ice may split or crack because it freezes in a short time.

How much time does it take to make Ice?

Ice making time will differ according to ice making compartment settings. Regular ice making is set at the time of purchase.

To switch between , , and .

- In addition to the surrounding temperature, water type, and water volume and temperature in the water tank, ice making times may vary with the following conditions, and be longer than those in the table.
 - In winter or at other times when the surrounding temperature is low
 - When the door is often opened and closed
 - When the freezer compartment is set to "L"
 - When Energy Saving Mode is set
 - When the ice tray is pulled out and reinserted during ice making
- When  is displayed, ice cannot be made. Cancel the setting.

About the Ice

- About 10 to 12 ice cubes can be made each time. The ice cube size and the number of ice cubes in one batch depend on various factors, such as the amount of water in the water tank. When few ice cubes are being made, pour water into the water tank.
- When ice is made using water with a high mineral content, such as mineral water, white deposits (white crystals) may form in the ice. This is the crystallized mineral content and is not harmful.
- If the ice is stored inside the ice storage box for a long time, ice cubes may join together or shrink (due to a phenomenon called sublimation).

Caution: Be careful when breaking apart ice stuck in the ice storage box. There is a risk of injury.

Versa Compartment

The versa compartment can be switched between "Soft-Freezing" and "Freezer." Placing food in

the versa compartment and using  "S-COOL FREEZE" or  "HOT FREEZE" mode allows food to be frozen without losing its taste and texture.

Soft-Freezing / Supercool Freezing

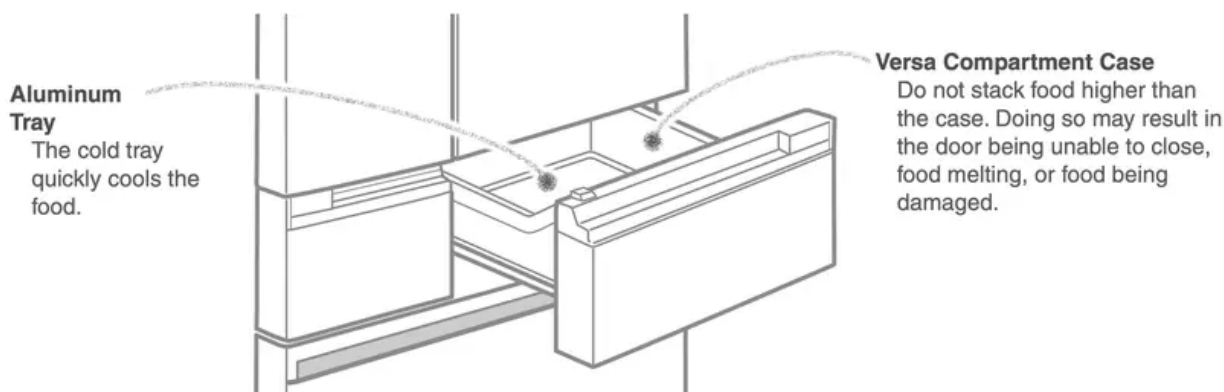

What can the versa compartment do?

The temperature in the versa compartment can be adjusted by switching between Soft-Freezing and Freezing. With Soft-Freezing, to freeze food, use . For freshly cooked rice or other warm food, use .

Performing temperature adjustment

Operation Panel Display	Versa Compartment Condition
	<p>Soft-Freezing</p> <p>Food can be cooked immediately after being taken out. Meat, fish, etc. can be stored for 2 to 3 weeks*¹. This is set at the time of purchase.</p> <p>With ❄️ and ❄️, food can be frozen even more deliciously.</p>
	<p>Freezing</p> <p>Meat, fish, etc. can be stored for about 1 month. For storing ice cream and frozen foods, use "FRZ•H".</p>

*1 The preservation period varies depending on the types of food and the condition when food was placed inside.

To supercool freeze such as meat, fish, and dessert

Supercool Freezing ❄️

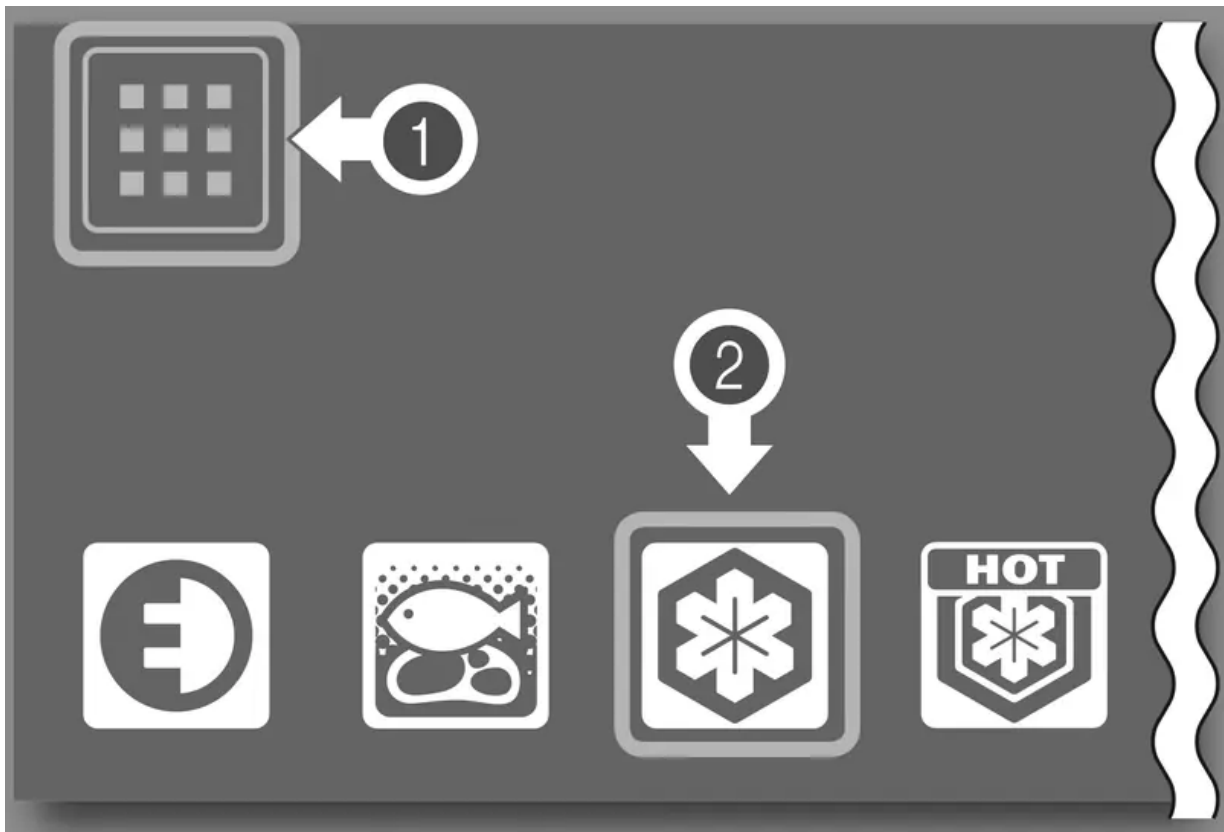

Foods such as meat, fish, and dessert can be deliciously frozen. Place food in the versa compartment before setting. Reset if placing new food inside even it was already set.

To Set

1. Touch  on the operation panel.

2. 

Touch  .

The letters above the icon will light up.



3. 

Touch  .

The settings are finished.

This ends automatically after about 8 hours.

After it ends, the food will be stored in Soft-Freezing mode.

Selecting  will cancel  .

To Use Supercool Freezing on Hot Cooked Foods such as Freshly Cooked Rice, Curry, and Sauces

Hot Freezing 

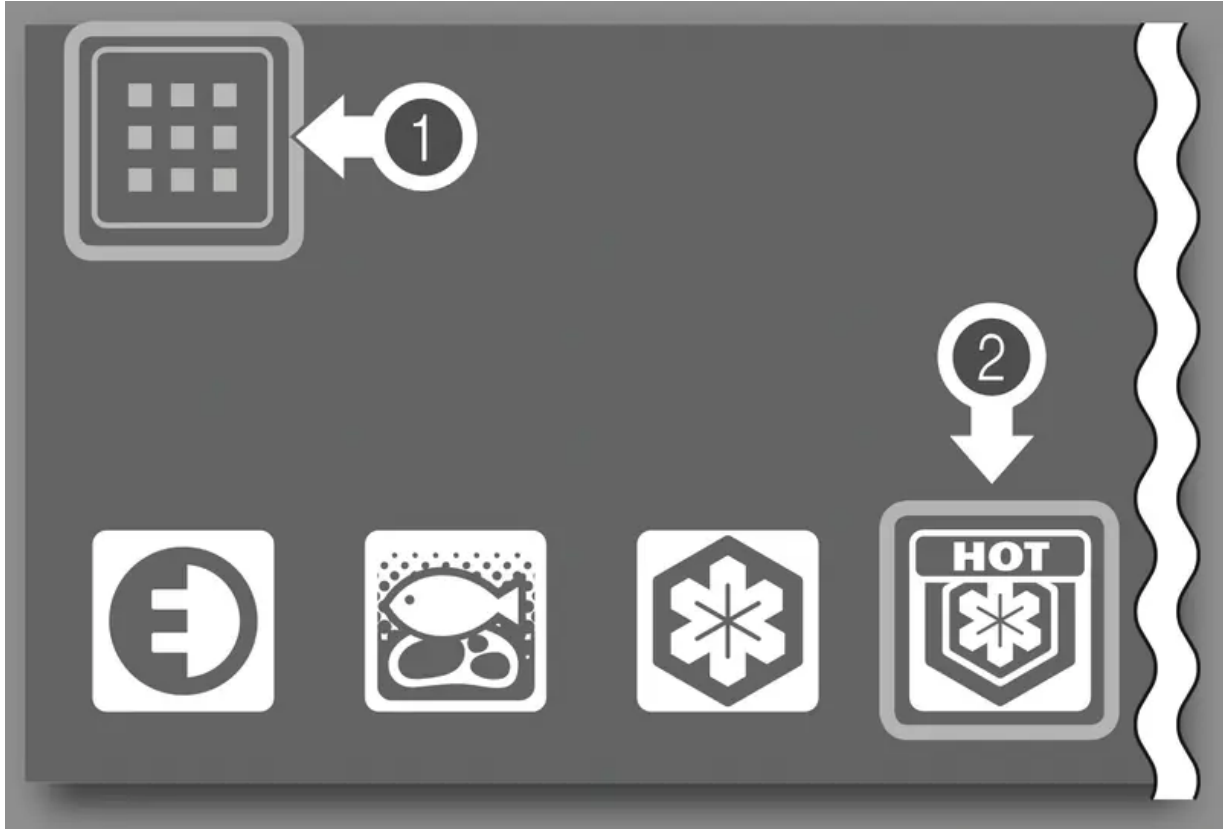

Hot or warm cooked foods such as freshly cooked rice, curry, and sauces can be deliciously frozen.

It can also be used to cool the food just after cooking.

Place food in the versa compartment before setting.

Reset if placing new food inside even it was already set.

To Set

1. Touch  on the operation panel.

2.



Touch .

The text above the icon will light up.



3.



Touch

The settings are finished.





This ends automatically after about 9 hours.

The letters above the icon will light up until it ends.



After it ends, the food will be stored in Soft-Freezing mode.



Selecting  will cancel .

Tips

- With  “Supercool Freezing” and  “Hot Freezing” (both referred to as “Supercool Freezing”)...
 - At times such as storing new food, please set  or  again, and reduce the opening and closing of the doors as much as possible.
 - If you want to store food frozen with Supercool Freezing for a long time, move it to the freezer compartment quickly. Because food moved to the freezer compartment will freeze and harden, please thaw out food before using it.
 - Please do not store food that is hotter than 80°C.
- With Soft-Freezing...
 - When you have frozen a food too hard, leave it at room temperature for about 5 to 15 minutes. It will become easy to cut.
 - Adjust the temperature according to how the food is frozen.
 - If the temperature setting of food is switched from freezing to Soft-Freezing, the food should be consumed as soon as possible (within 1 to 2 weeks).
 - Even if fruit is thawed, it does not return to its original condition. Eat frozen fruit without thawing it.
 - If fruit is stored for more than a week with Soft-Freezing, its taste may change. We recommend eating within 2 to 3 days.

Notice

- Supercool Freezing cannot be performed during Power Save Mode.
- When performing operations with  or  in **2**, if a continuous beeping sound occurs and the setting cannot be performed, the temperature setting is set to “Freezing.” It can be set when Soft-Freezing.
- You can use Supercool Freezing even when other foods are still inside.
- Even after Supercool Freezing has finished, the food may not be completely frozen. (When the temperature is set to Supercool Freezing or Soft-Freezing, because food is frozen at about -7°C, it may take about 24 hours for the food to freeze completely.)
- The degree of freezing or freezer burn may vary depending on the food type, cooking method, storage arrangement (stacking, storage location), the amount of food, and the storage time.

- Depending on how much sugar, salt, moisture, or fat the food contains, freezing may not be possible or the food may harden when frozen (cannot be cut immediately with a kitchen knife).
-  Use  for food that is warmer than body temperature.

Freeze foods with their original flavors. The frozen foods do not have to be thawed before being consumed.

Food can be frozen, while preserving its taste and texture.

Supercool Freezing

Significantly reduces dripping during thawing and the loss of nutrients, preserving flavor

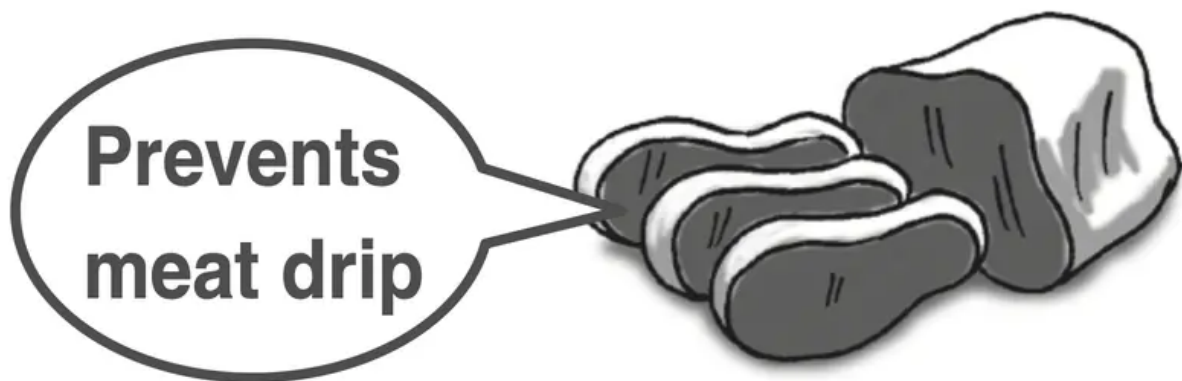

Cut steak meat and blocks of meat into 100 to 200 grams and use  "Supercool Freezing" prevent dripping and preserve the taste and nutrients of food through Supercool Freezing.

Hot Freezing

Things unsuitable for freezing such as potatoes and bamboo shoots can be frozen



**You can
batch cook**



Use "Hot Freezing" to keep potatoes in curry fresh. Just thaw the curry out for that fresh-cooked potato texture. There is none of the bother to remove potatoes before freezing them.

Hot Freezing

Freshly cooked rice can also be frozen while hot



**keep savory
taste**



Use "Hot Freezing" to preserve the flavor of freshly cooked rice. Thaw it to enjoy its glutinous texture.

Since food can be easily cut even when frozen, it can be cooked without thawing.

Meat

Ground meat / Blocks of meat

It can be cut with a kitchen knife easily without thawing. Because it can be cut while frozen, whatever you will not use can be returned to the versa compartment. Food can be used without being wasteful.



Thinly sliced meat / Bacon

You can easily separate them one by one and slice them finely without thawing. They will thaw while basting.



Fish

Cutlets

You can easily separate them.

No need for dividing them by the amount per serving before freezing. Purchased packs can be frozen as it is. Bake them at low heat without thawing and there is no trouble.

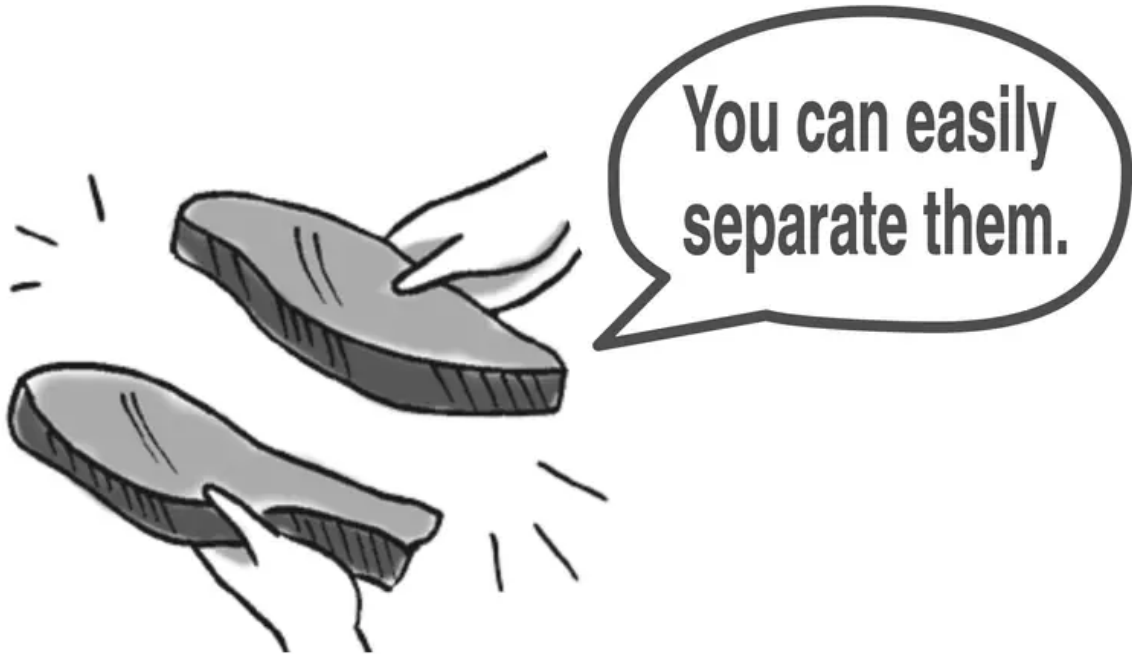

Sauces

Meat sauce



If there is sauce left over, place it in a storage container and use "Hot Freezing" Scoop out only the necessary amount and dress the pasta with it to easily make a meat sauce pasta.



Freezer Compartment and Versa Compartment: Using them properly

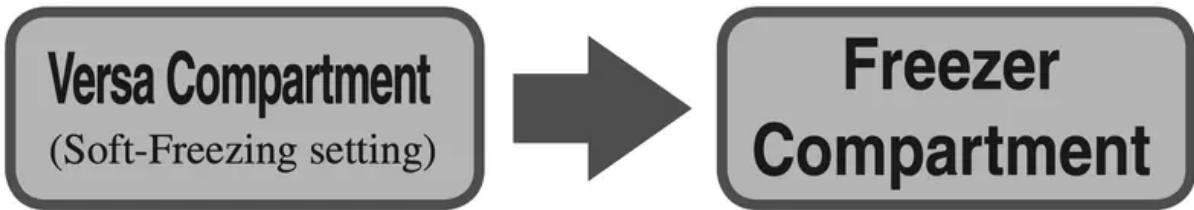

Make a large batch of simmered foods that are delicious when cooked in a large batch, then use



"Hot Freezing" on the excess amount. Move the supercool frozen food to the freezer compartment to preserve for a long period of time. This can also save the time and labor of cooking every day.

* Meat and fish can be preserved in a freezer compartment for about 1 month, but the preservation period will differ according to the freshness of food before storing it.

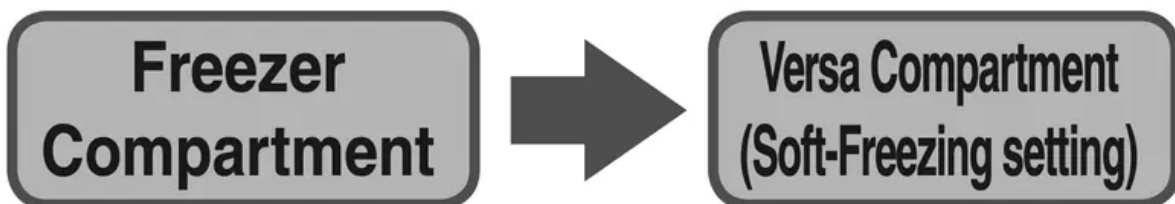

This is recommended for when you would like to consume food without thawing.
Food that has been moved to the versa compartment (set to Soft-Freezing) can be cut to just the portions necessary, so food is not wasted.
Although this differs depending on the size of the food, most food can be cut in about 2 to 5 hours.
* Use food within a short period of time (about 1 to 2 weeks).



Freezer Compartment

Store frozen food and ice cream. Store bread, meat, and fish through freezing.

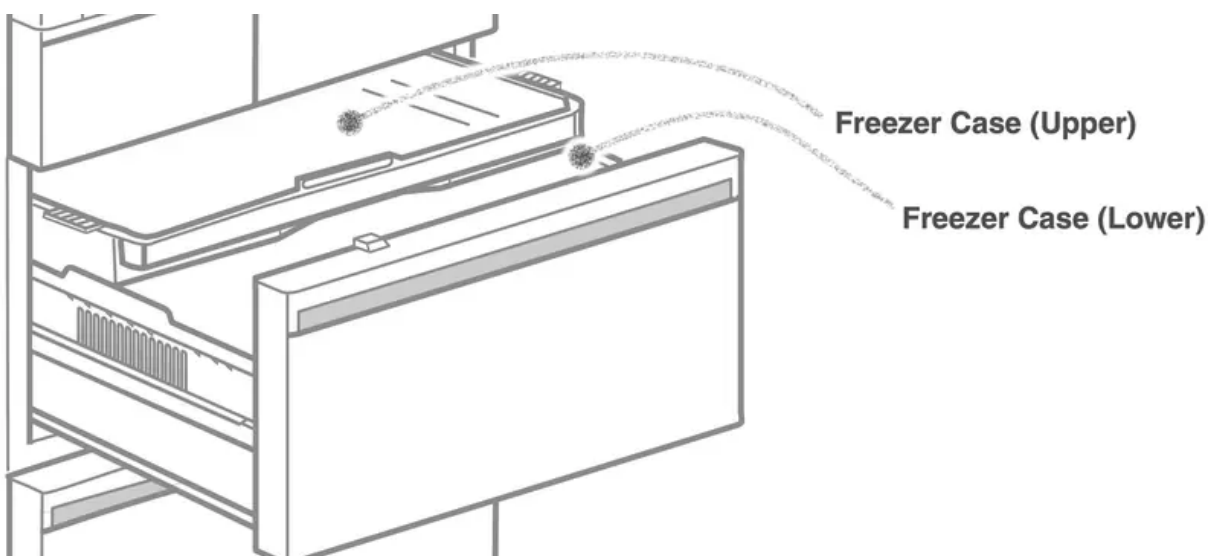

Tips

- Do not place tall objects in the freezer case (lower).
Food or the freezer case (upper) may become damaged or the door may not close, causing the accumulation of frost or lowering the cooling performance.
- Do not put in plastic drink bottles other than those meant for freezing.
The frozen contents may break the bottle.

Vegetable Compartment

Place vegetables, fruits, and beverages in this compartment. It preserves food, maintaining the moisture that would normally go away over time.

Storing fruits and vegetables in plastic wrap keeps them even fresher.

The clean tray is provided for easy cleaning of the vegetable compartment

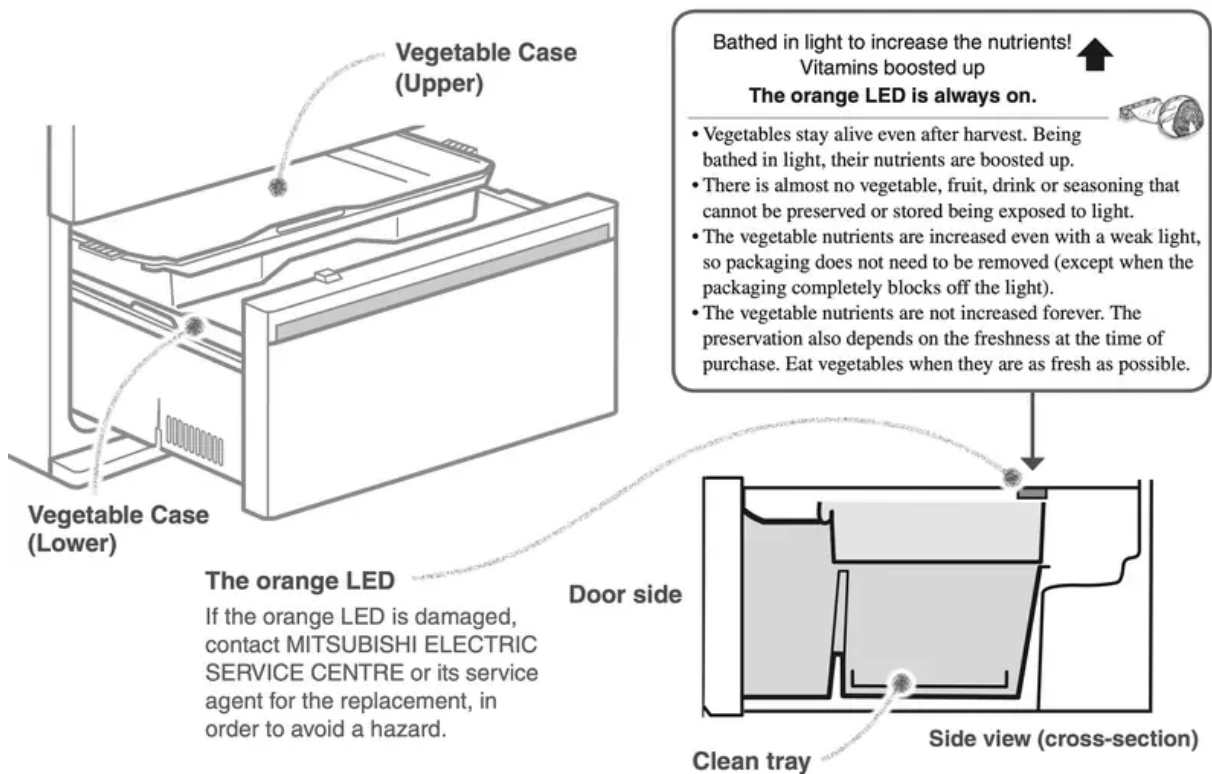

About the clean tray

When vegetable scraps accumulate on the clean tray or the tray becomes dirty, you can remove the tray from the refrigerator and clean it.

The clean tray is treated with a coating, which makes it easy to wipe and clean even when it is stained.

(Before you clean it, remove foodstuff from the tray.)

When the clean tray is stained

- The coating may peel off in the event of following.
 - If the clean tray comes into contact with a bottle, can, or solid foodstuff or when the surface of the tray is rubbed with force.
 - If the clean tray is soaked in water for a while to clean it or if the tray is wiped with alcohol.

Tips

- Do not pile food higher than the height of the vegetable case (lower) or vegetable case (upper).
Food or the vegetable case (upper) may become damaged or the door may not close, causing the accumulation of condensation or lowering the cooling performance.
- Because the vegetable compartment has a high humidity depending on the amount or types of vegetables, frost or condensation may form on the roof of the vegetable compartment or the surface of the cases. When condensation forms, wipe it off with a dry cloth.

Cleaning

To prevent the growth of limescale and mold, clean periodically. Do not use a dishwashing machine, because it may deform the parts. Do not use the following for cleaning .

- Items such as sponges or scrubbers that may damage surfaces
- Cleaners such as alkaline detergents, scouring powder, boiling water, petroleum, or acid

Once a week Water Tank / Water Supply Pump

If mold forms easily in certain types of water, clean about 2 or 3 times a week.

* When not making ice, remove the water.

1. Remove the water tank, remove the lid, and wash it.

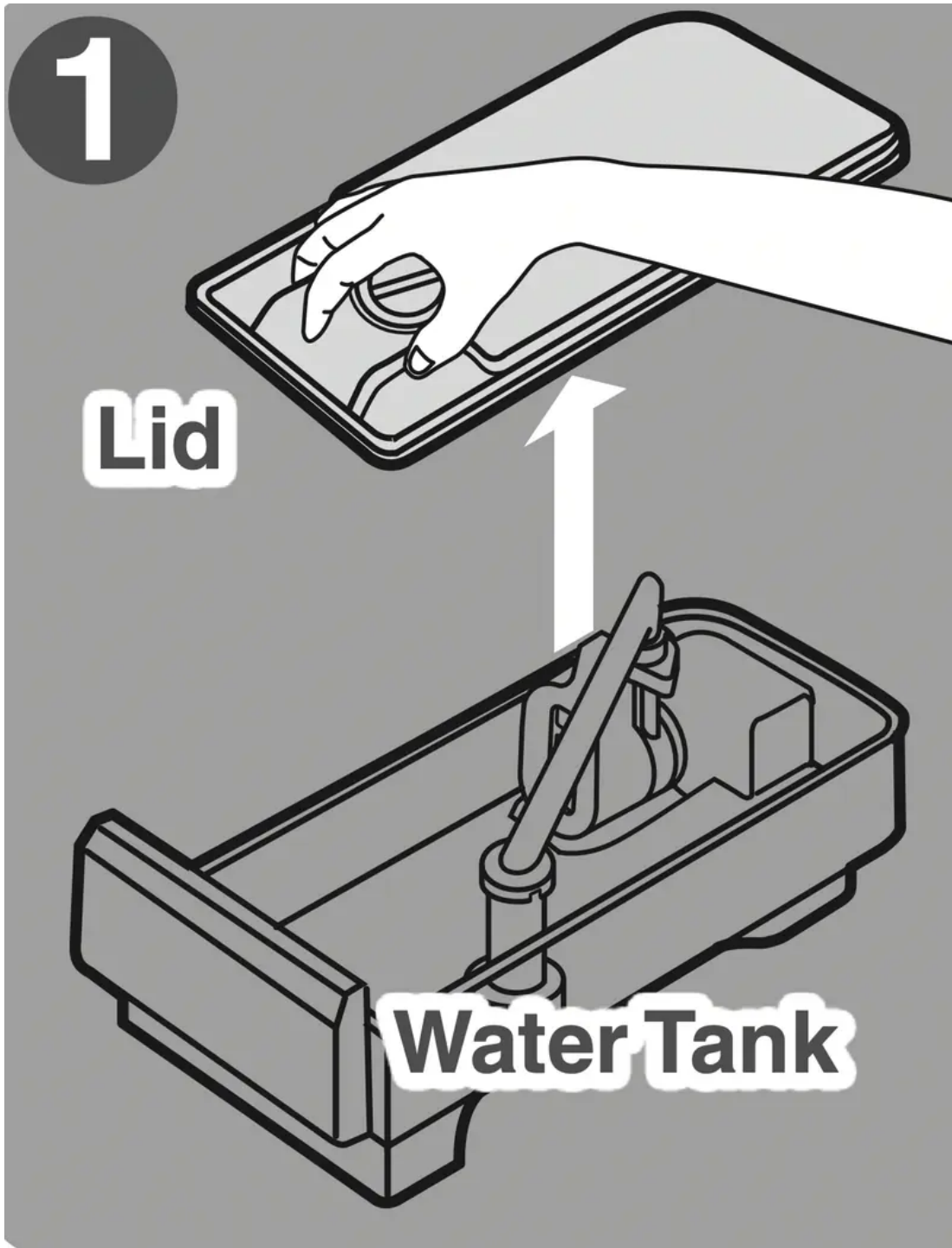

Remove the tank cap by twisting it.

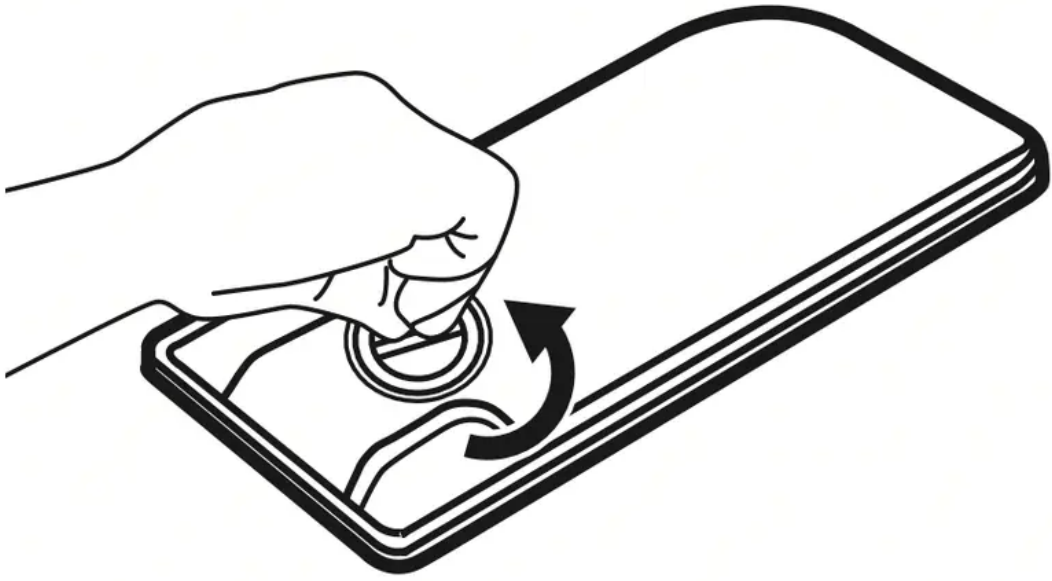

When using bleaching agents to clean the water tank and lid, follow the instructions of the agents.

2. Pull out the tank packing from the water tank.

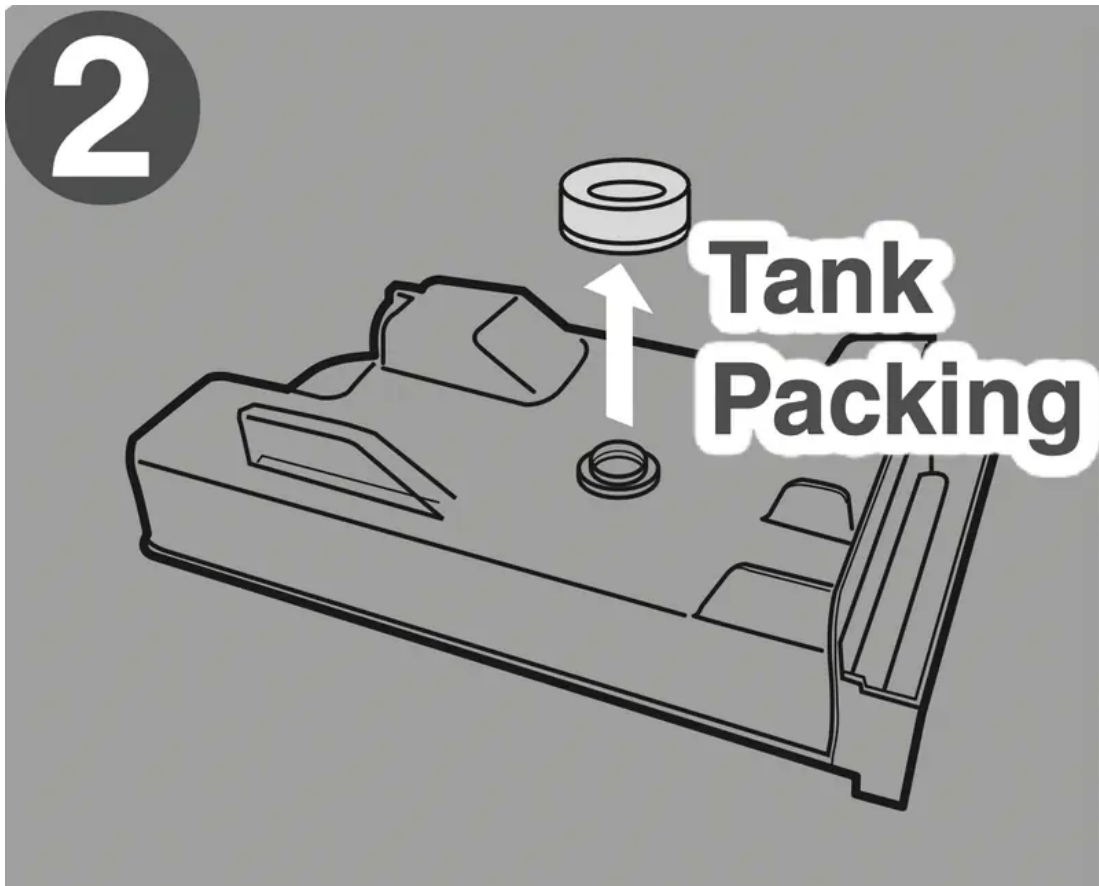

3. Pull out the tank pipe and rotate and remove the water supply pump.

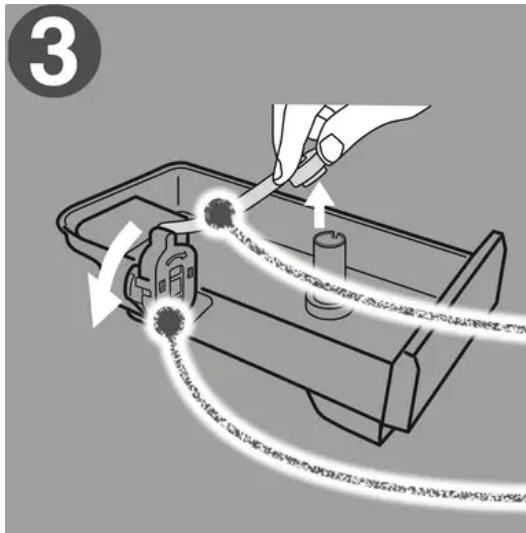

Tank Pipe

Water Supply Pump

Wash the water tank

4. Disassemble the water supply pump and wash it.

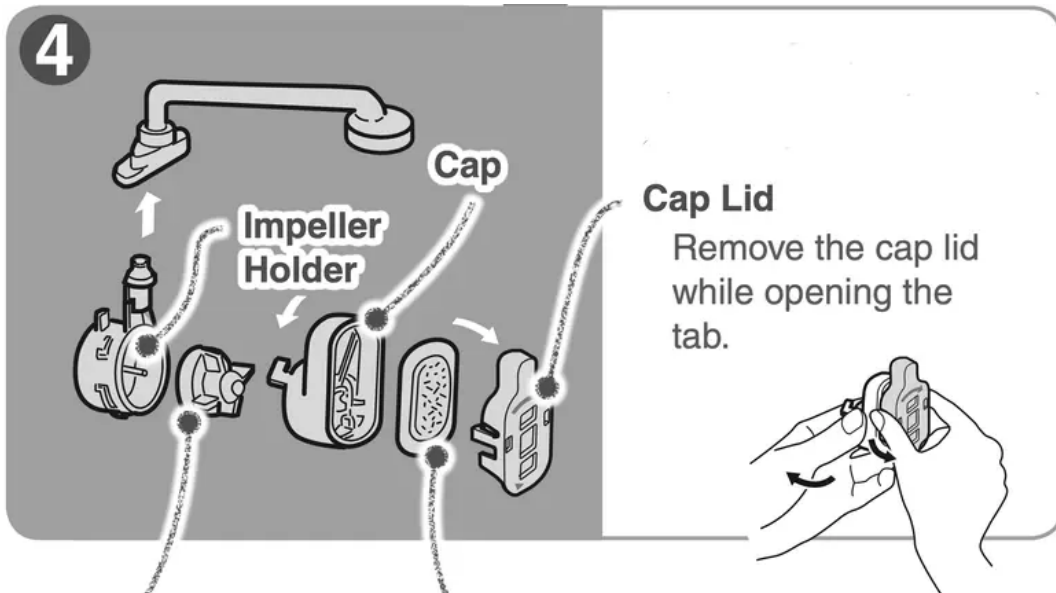

Cap

Impeller Holder

Cap Lid

Remove the cap lid while opening the tab.

Impeller

The impeller is made from a magnet. Wash it thoroughly to remove any foreign objects.

Chlorine-Cleaning filter

Wash by lightly rubbing.

*Do not use cleaners such as kitchen detergents (neutral), benzene, or bleach. Doing so may result in odors of the ice.

5. Assemble the water supply pump.

Fit the filter onto the cap.

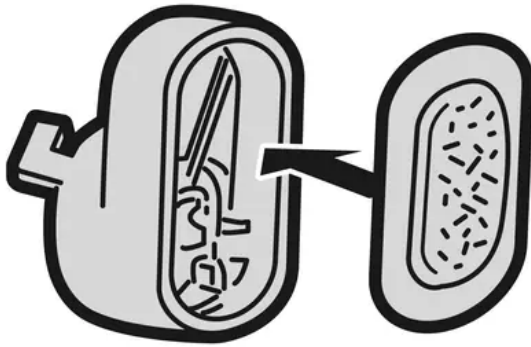

Fit the cap lid onto the cap.

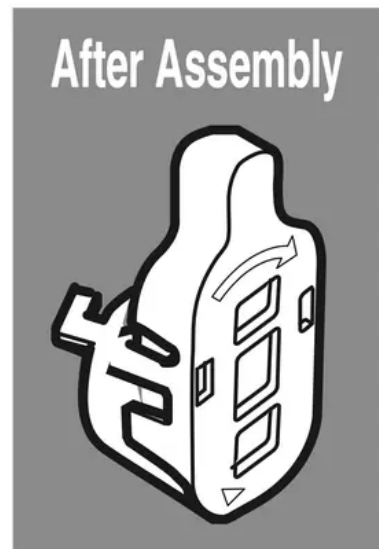
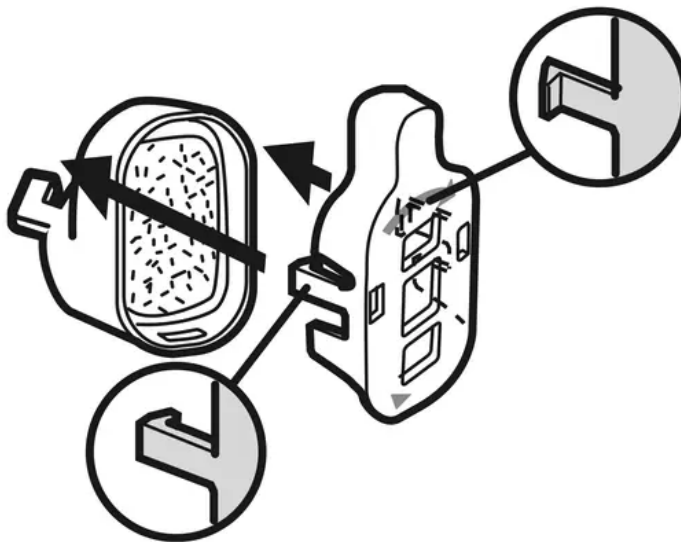

Attach the impeller to the impeller holder.

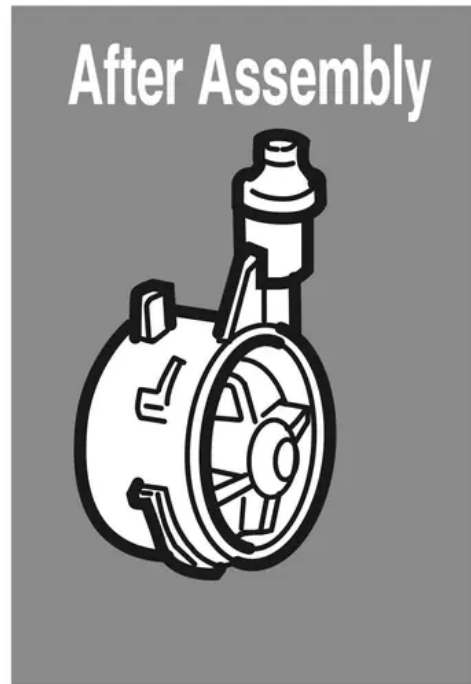
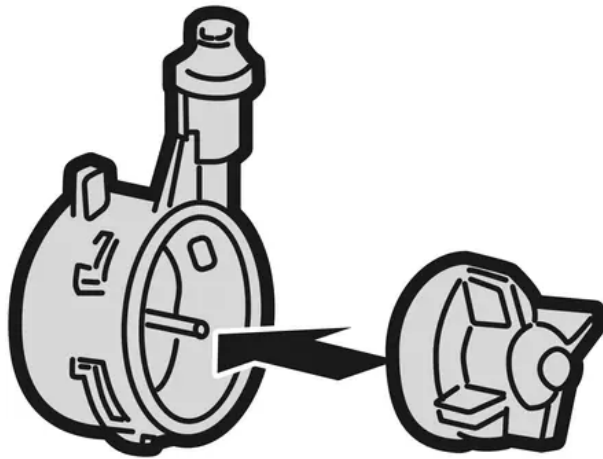

Rotate and fix the tab (1) of the cap into the projection (2) on the impeller holder. Make sure that the impeller is inside.

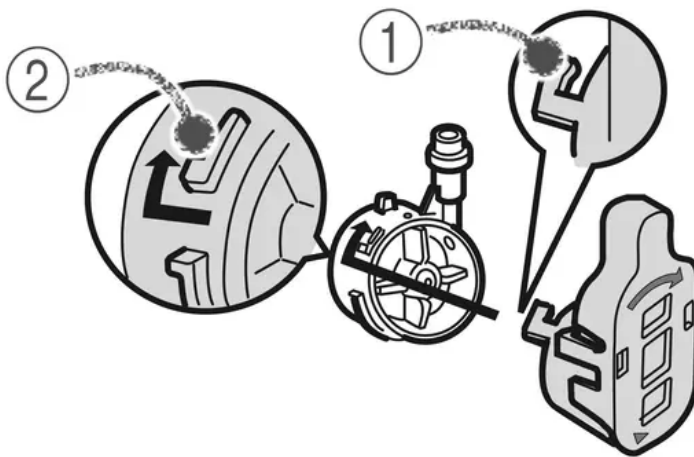

Rotate and set the water supply pump onto the water tank. Align the triangle mark on the bottom of the water tank with the triangle mark on the cap



lid and push in while making sure that there is no gap.

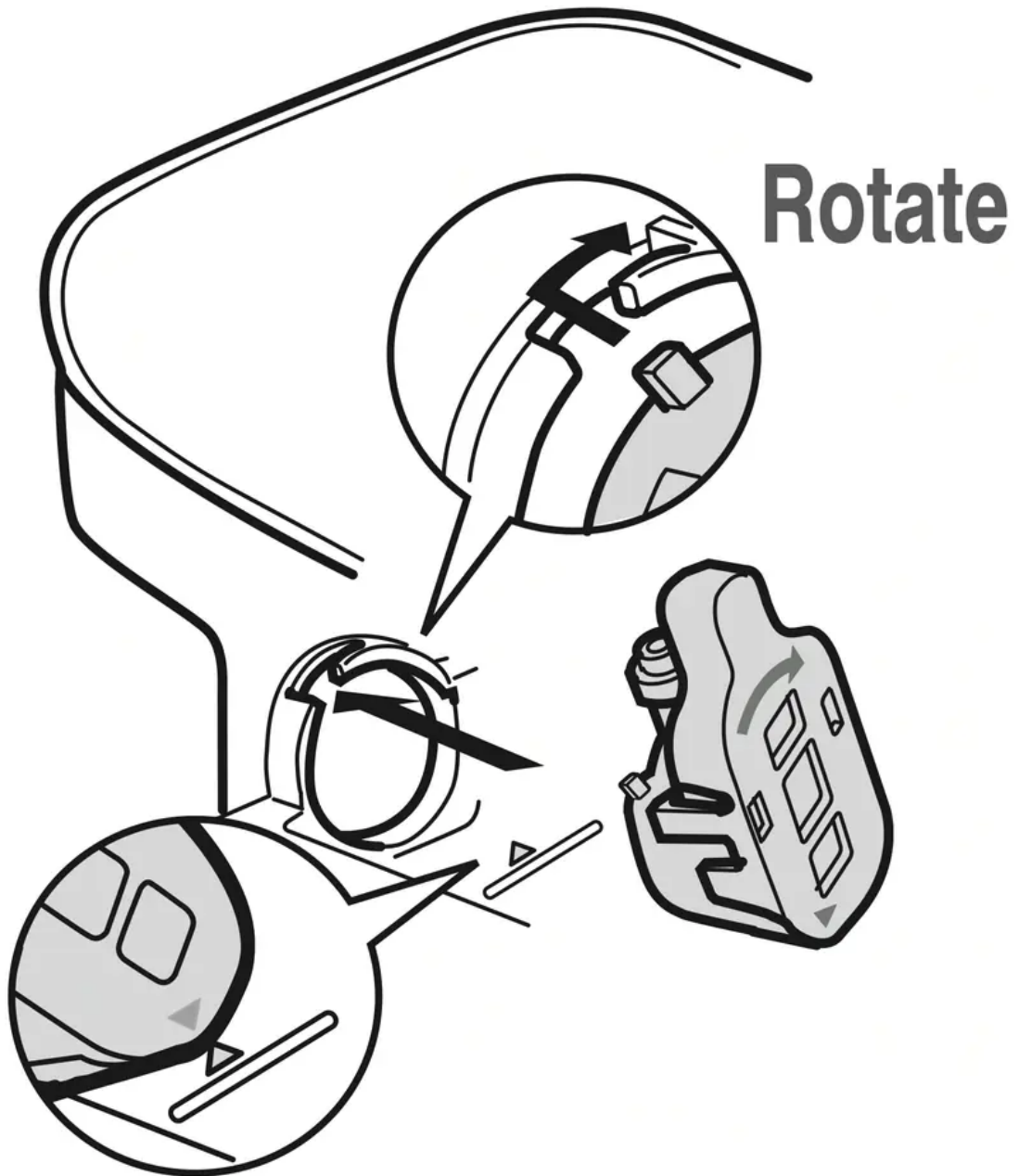

6. Install the tank pipe.

Insert the tank pipe into the water tank.

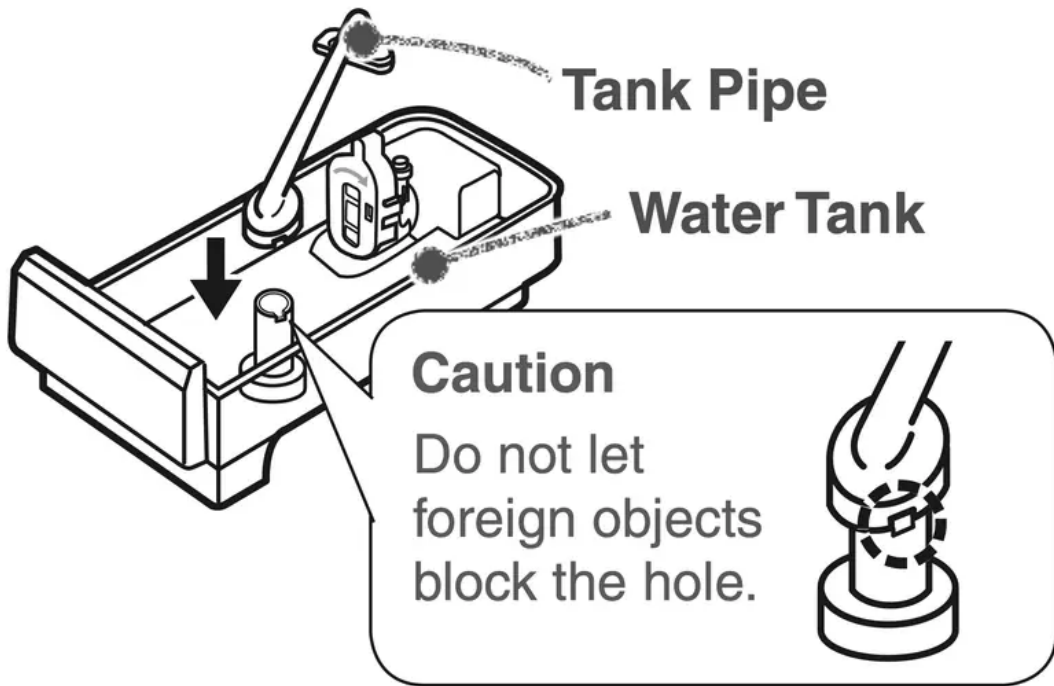

Connect the tank pipe to the water supply pump.
Check that there are no foreign objects between the tank pipe and the water supply pump.

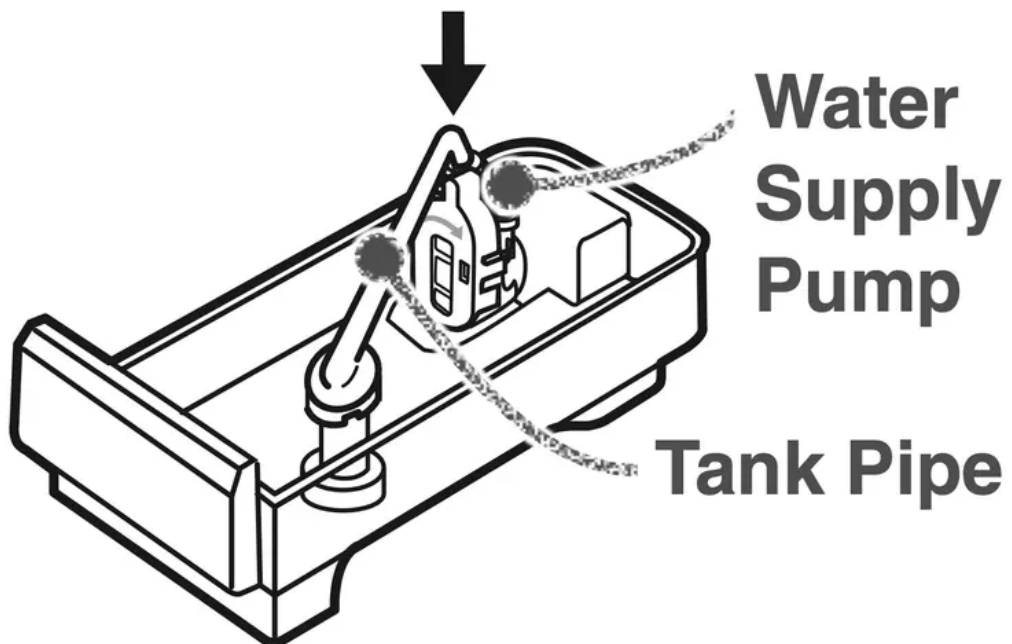

Install the tank packing

Tank Packing

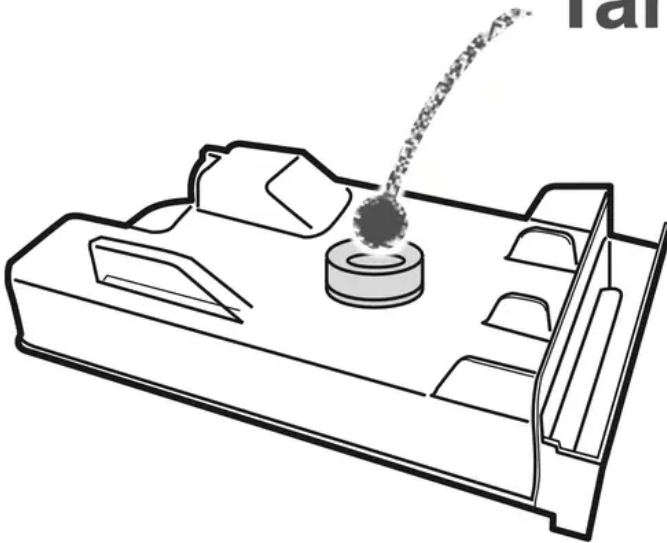

Once a month Water Supply Pipe and Tank Holder

1. Pull out the water supply pipe and wipe the tank holder with a clean cloth.
Do not pour water into the tank holder. Doing so may cause a malfunction.

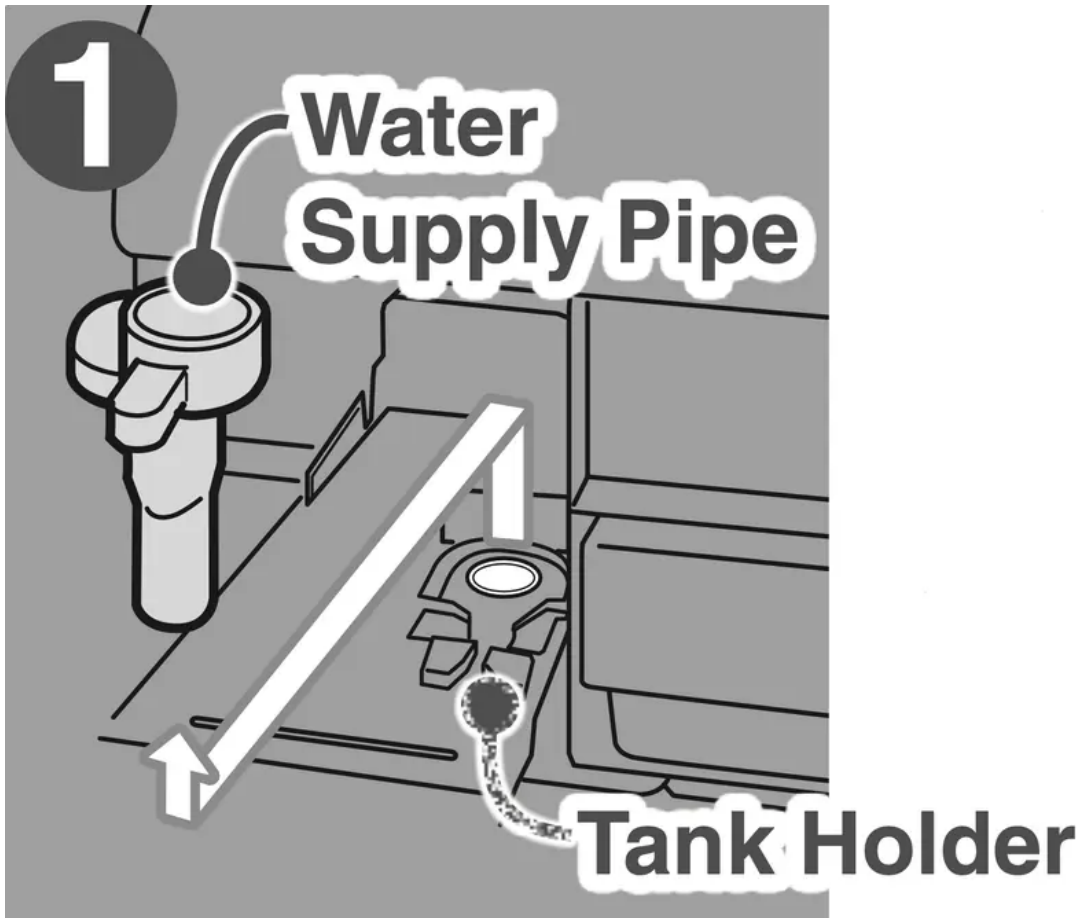

2. Disassemble and wash the parts.

Twist and remove the water supply pipe.

White minerals or chlorine accumulation may adhere to the parts, this is not abnormal.

Wash off such substances and reuse the parts.

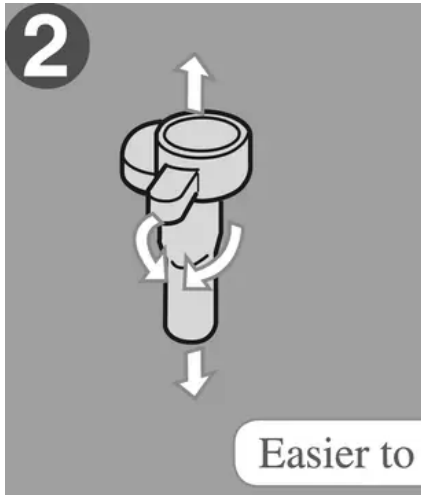

Easier to disassemble/assemble when wetted

3. Follow the procedure in reverse to return the parts to their original positions.

Push in the water supply pipe firmly so there are no gaps.

If there are gaps or looseness, it may cause a malfunction.

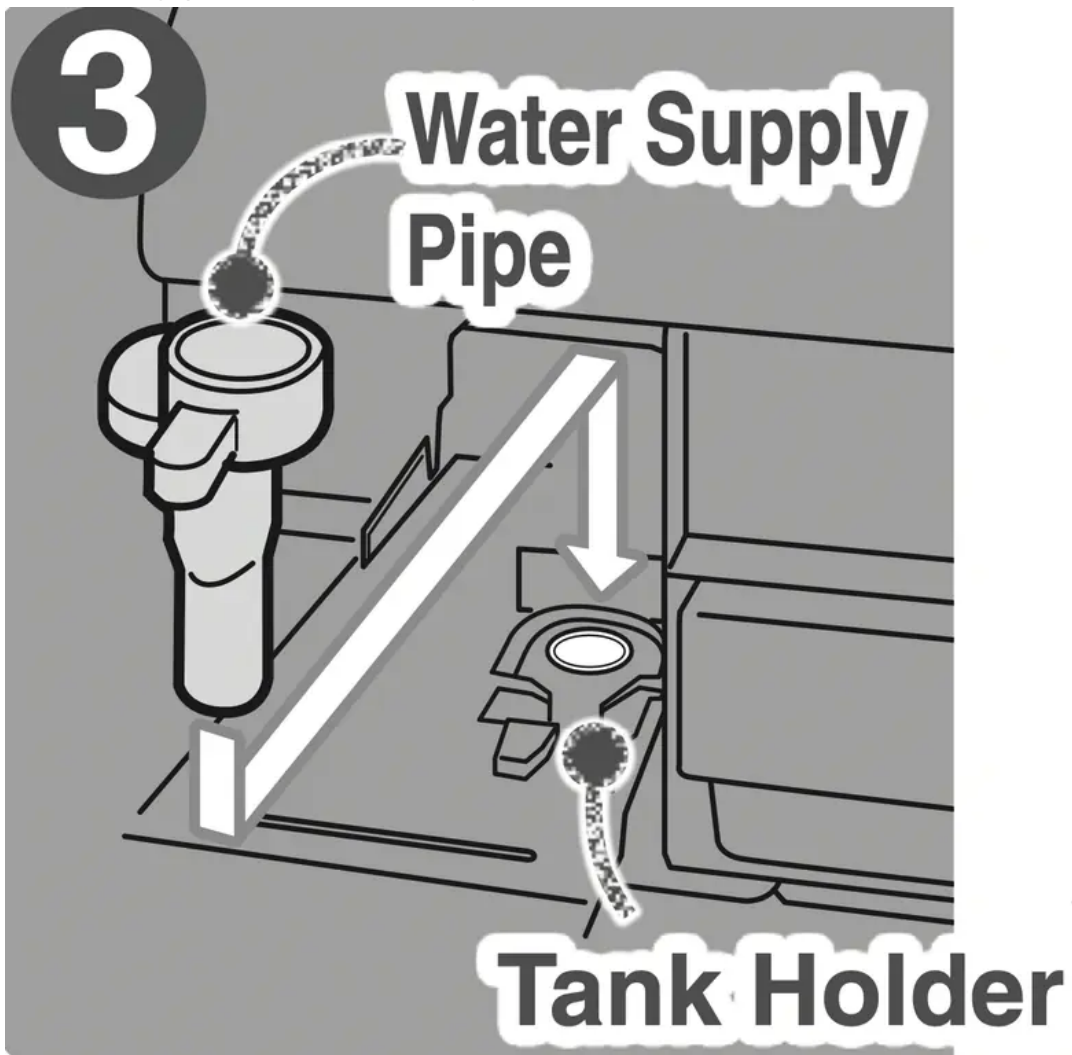

4. Check whether there are any foreign objects between the water supply pipe, tank packing, and tank holder.

Insert it horizontally so that there are no gaps.

Failing to do so may cause noises to occur, ice to not freeze, and may also cause the water in the water tank or food in the refrigerator compartment to freeze.



1 to 2 times a year Ice Tray

Before cleaning, make sure to set "Stop Ice Making."

1. Open the door of the ice making compartment and unlock the ice tray lock lever.

ICE TRAY

will appear on the operation panel.

If the alarm sounds continuously when the ice tray lock lever is unlocked, lock the lever,

close the door, wait for the blinking **ICE** to turn off, and then try again.

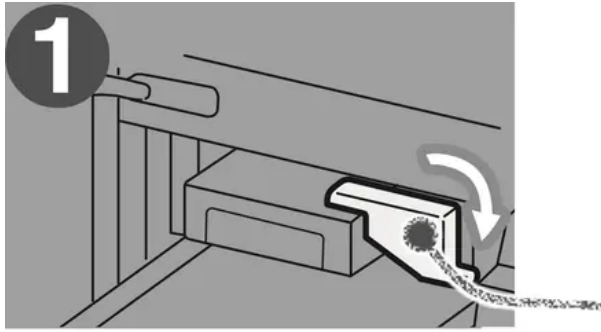

Ice Tray Lock Lever

2. Pull the ice tray towards the front and then remove it.

There is a risk of the water spilling. Pull out the tray slowly.

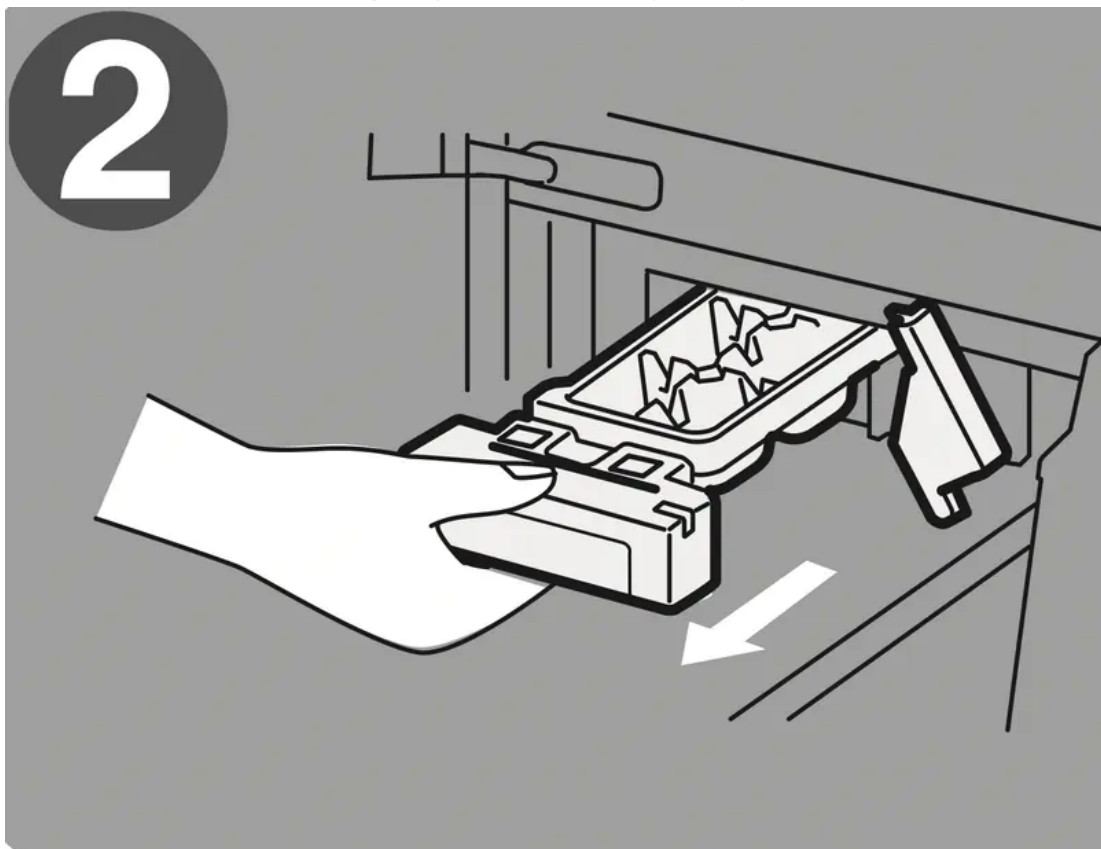

3. Empty the ice tray and wash it.

Do not use a sponge or scrubber. A damage may cause malfunction.

After washing the tray, dry off any moisture.

4. Attach the ice tray.

Push in the ice tray until it makes a clicking sound, and then lock the ice tray lock lever.

ICE TRAY

will disappear. If the lamp does not disappear, check the position of the ice

tray lock lever and the up and down orientation of the ice tray.



Notice

- If the water supply pipe and tank packing are not installed, they may cause the water in the water tank or food in the refrigerator compartment and sliding cases to freeze.
- Replacement is not usually required for the Chlorine-Cleaning filter. However, it may require replacement in the following cases.
 - When it clogs because something other than water was put in the tank
 - When it has broken
 - When mold has grown

To purchase a new filter, contact the retail store where you purchased the refrigerator.

* If mold forms easily in certain types of water, clean about 2 or 3 times a week.

Removing and Cleaning the Parts

Caution:

- Remove the power plug before cleaning.
Otherwise an electric shock or injury may result.
- Do not disassemble, repair, or alter.
- Do not use while parts are damaged.
Doing so may cause injury, electric shock, or fire.

* After cleaning, wait at least 10 minutes before reinserting the power plug into the socket. If you insert the plug immediately, there will be an overload on the machine.

How to Clean

Q. What should I do if I notice the refrigerator is dirty?

A. Before the dirt becomes hard, wipe it off.

- Wipe with a soft cloth soaked in warm water.
- For stubborn dirt, wipe using water mixed with a weak concentration of kitchen detergent (neutral).
- Especially in the case of oil stains and citric fruit juice, wipe it off immediately.
- If dirty door packing is ignored, it can be damaged and cause cold air to leak. After wiping with a soft wet cloth, if there is still moisture, finish wiping with a dry cloth.

- If the clean tray is soaked in water for a while to clean it or if the tray is rubbed with force, the coating will peel off.

Wipe the tray with a soft cloth soaked in warm water.

Q. Can the shelves, cases, and pockets be removed?

A. For information on which parts can be removed

Q. What should I do with doors and shelves made of glass?

A. Wipe with a soft cloth soaked in warm water.

- If a door or shelf made of glass has cracked or shattered, do not touch the broken glass, but contact the retail store where you purchased the refrigerator immediately.
- Magnets will not adhere to a glass door.
- Wipe any leftover moisture with a dry cloth.

Tips

- **Do not use the following items.**

Alkaline or low alkaline kitchen detergents, scouring powder, powdered soap, alcohol, benzene, thinner, petroleum, acid, scrubbers, boiling water, or similar substances.

Doing so may cause the plastic parts (such as the door handles, caps, cases, etc.) to split, or damage or rust the glass doors, shelves, or painted surfaces.



Power Plug

For safety, clean the power plug and cord periodically.

1. Remove the power plug from the socket.

2. Check for damage or abnormal heating on the power plug and cord.
3. Remove any dust from the power plug and surrounding area, and then wipe with a dry cloth.
4. Firmly insert the power plug into the socket.

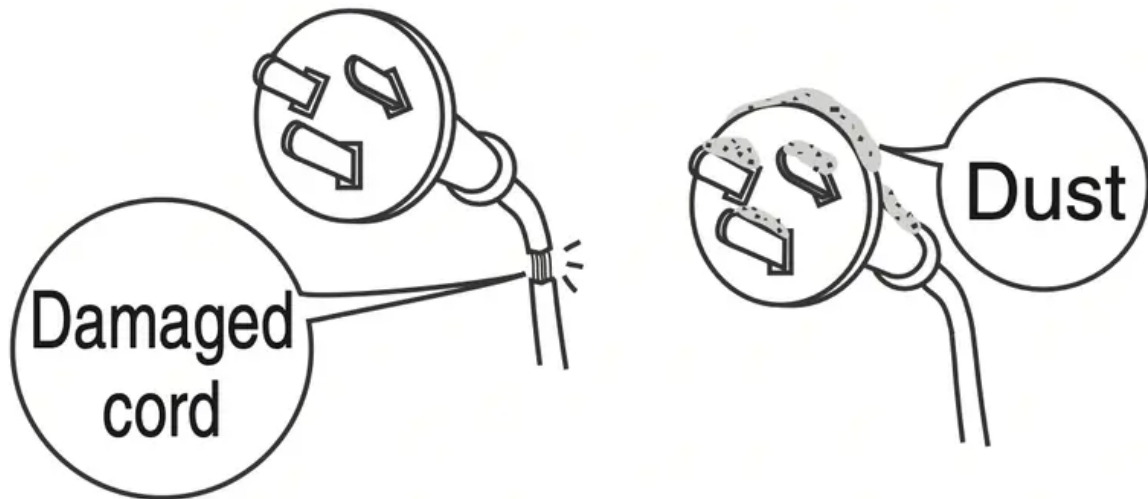

Replace

Clean

Follow the instructions: Remove dust periodically from the power plug. Dust may cause insulation failure, resulting in fire.

Refrigerator Rear Side and Floor

This is a place where, because of the convection current of the air, dust tends to gather and can easily turn black. Also for the purpose of saving energy, clean periodically.

1. Remove the adjustable support cover. 2 Turn the adjustable supports to raise them from the floor, and pull out the refrigerator.
2. We recommend laying out protective material on the floor to prevent the floor from being damaged. Also, be careful not to injure yourself.
3. Remove dust from the refrigerator's rear side, the wall, and floor, and wipe off all dirt.
4. Check for water dripping on the floor.

Dust, etc.

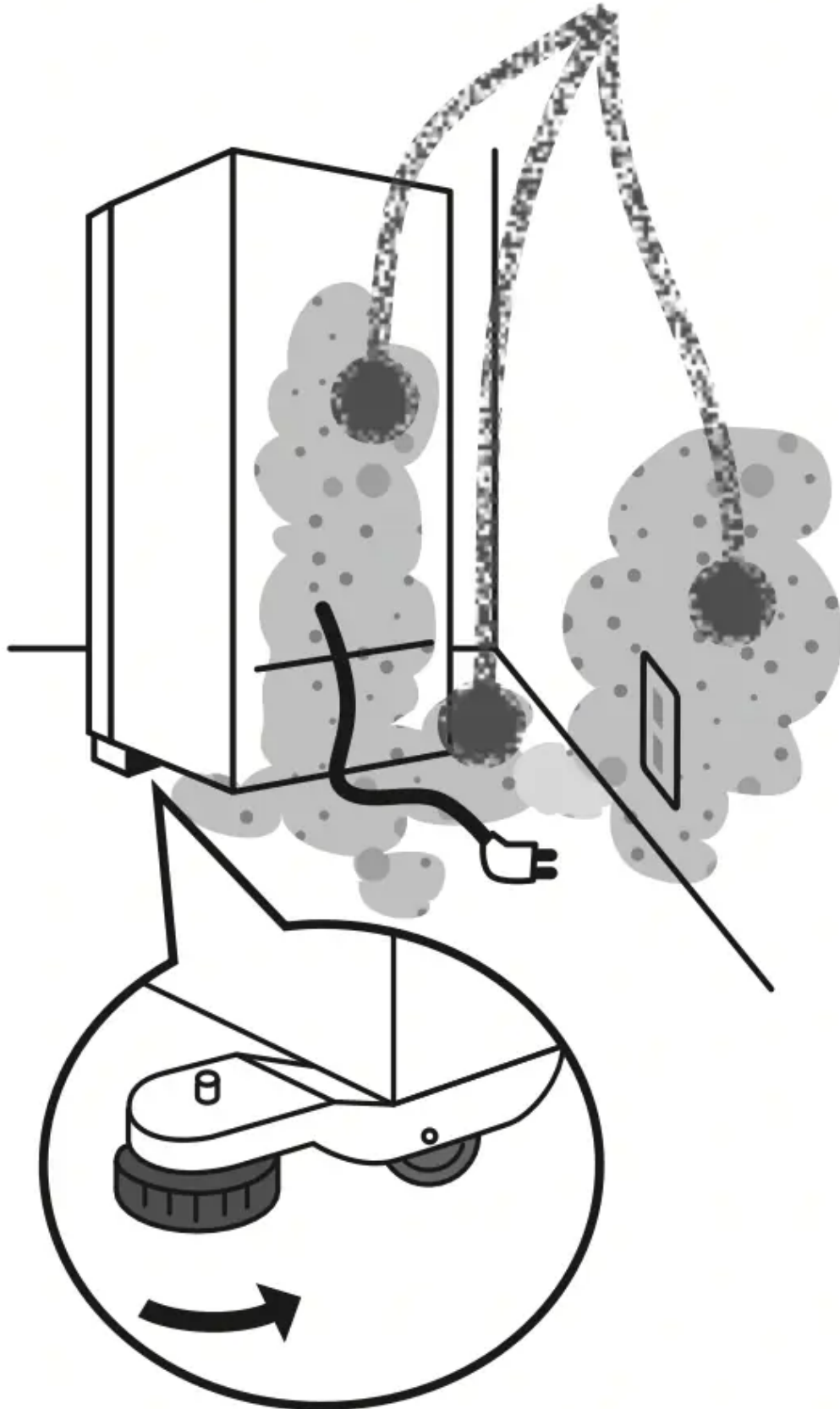

Prohibited: Do not put your hands under the refrigerator. It may cause injury.

When attaching parts, use the backward procedures of removal.

Glass Shelf (Upper) (Middle) (Lower)

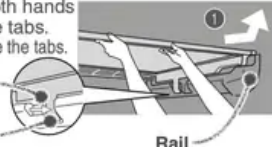
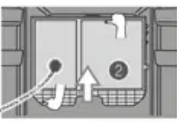
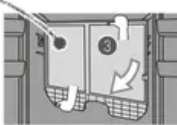
- 1 Pull out to the front using both hands until making contact with the tabs. Lift the front of the shelf to remove the tabs.
Pull out until making contact

- 2 Hold the front and back of the glass shelf (lower) and pull the back out to the front of the rail. Lift the front to make the glass shelf upright.
Backside (in the upright position)

- 3 Pull out the right side or left side of the glass shelf (lower) (in the upright position of 2) to remove from the refrigerator.

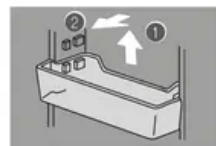

* Remove with the partition attached after you have removed the glass shelves (upper) and (middle) and slide glass shelf.

Adjustable Pocket (Large) (Small) / Bottle Pocket (Large) (Small)

- 1 Lift up the left and right of the pocket alternately.
 * The pockets are firmly installed.
- 2 Pull out to the front.



Adjustable Pocket



Bottle Pocket

! Be careful when attaching and removing the pocket. If it is attached improperly, it could come loose and fall, causing injury.

Follow the instructions

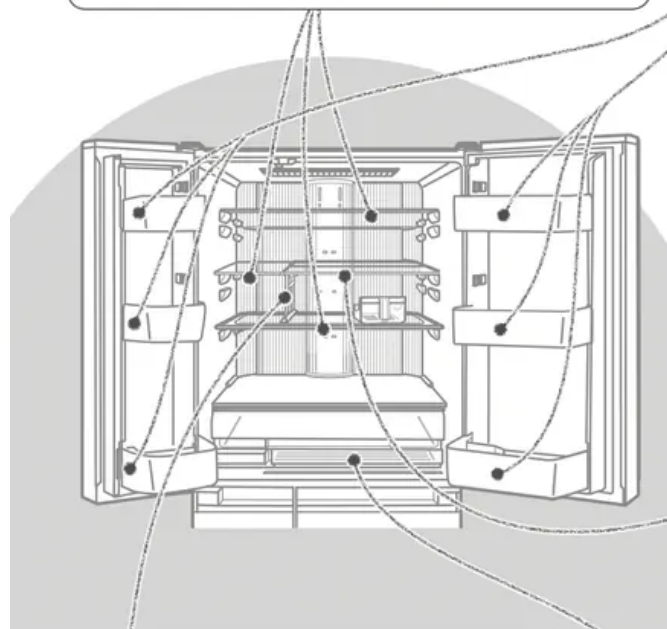

Slide Glass Shelf (Front) (Back)

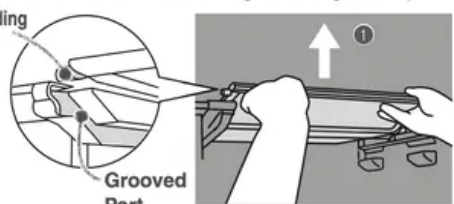
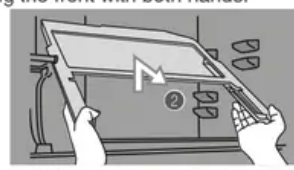
- 1 Remove the slide glass shelf (front) using the protruding parts in the front and back along with the grooved parts.

- 2 Pull the slide glass shelf (back) out to the front while holding the front with both hands.

* Swiftly pulling out the part to the front can damage the side of the door. Pull out the part slowly to remove it.

Partition

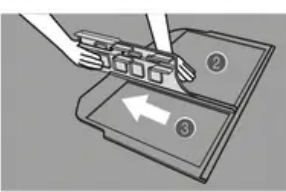
- 1 Remove the glass shelf (lower) and place it on a surface such as a stand.
- 2 Press the glass shelf (lower) down with one hand.
 * The shelves are firmly installed.
- 3 Pull in the direction indicated by the arrow.



Lower Case

- 1 Fully pull out the lower case.
- 2 Lift the lower case out to the front.

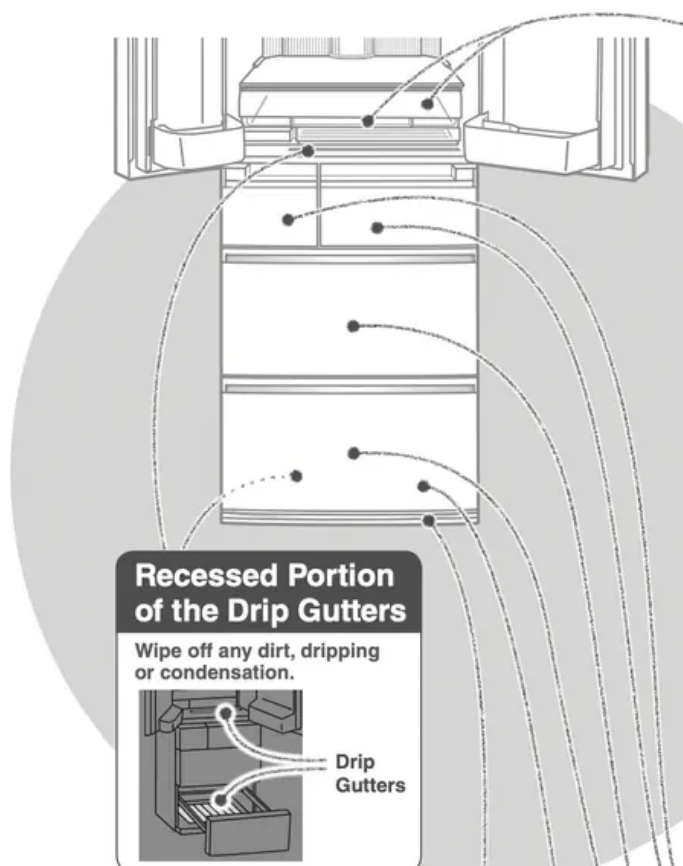

Upper Case / Upper Case Cover

- 1 Lift the upper case cover.
- 2 While pressing the end of the position indicated with Δ on the right, press the upper case cover to the left and warp it to remove.

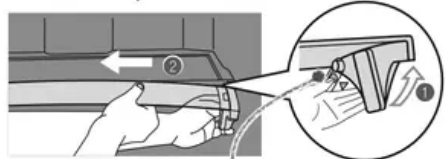

Press the end of the position indicated with Δ

- 3 Fully pull out the upper case and lift the front of the upper case until the bottom can be seen.

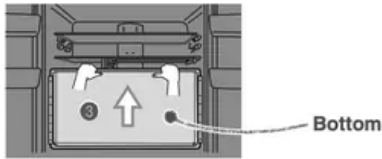

- 4 While tilting the upper case to your side, pull it out.

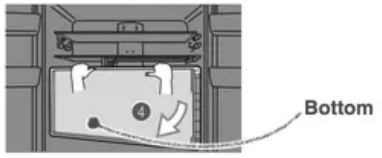

* When it is difficult to remove, remove the upper case after removing the adjustable pocket.

Recessed Portion of the Drip Gutters

Wipe off any dirt, dripping or condensation.

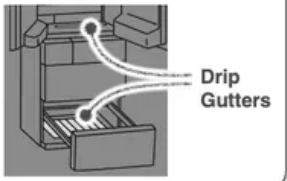

Adjustable Support Cover

- 1 Pull the left and right sides of the support covers to the front to remove them.

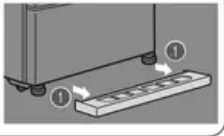

Clean Tray

- 1 Pull the vegetable compartment door all the way out.
- 2 Hold the handle at the rear center of the clean tray and lift the tray straight up.
* Do not tilt the clean tray too far. If you do, vegetable scraps may fall inside the vegetable compartment.
- 3 Pull the clean tray toward the front without hitting the tray against the partition.

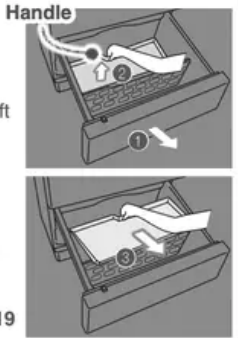

About the clean tray \rightarrow Page 19

Ice Making Compartment and Versa Compartment Case

- 1 Fully pull out the door.
- 2 Lift the case out to the front.

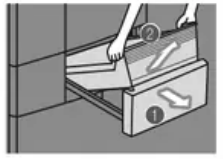

* The illustration represents the versa compartment. Remove the ice making compartment in the same manner.

Freezer Compartment and Vegetable Compartment Case

- 1 Fully pull out the door.
- 2 Lift the upper case out to the front.



- 3 Pull out while slightly lifting up the door, and then tilt.
- 4 Lift the lower case out to the front.

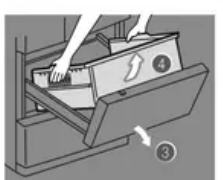

* The illustration represents the freezer compartment. Remove the vegetable compartment in the same manner.

Follow the instructions: Be careful not to hit your hand against or get your finger caught in the freezer compartment door or partition. There is a risk of injury.



Other Issues



(Power Outages, Child Safety Lock, Setting Reset, When Lights Up)

Power Outages



- Minimize the frequency of opening the doors, and avoid adding more food.
- Operation panel settings other than the temperature settings may change. Check the settings. (Child Safety Lock, etc.)

To Prevent Accidental Button Operation (Child Safety Lock)

Locks the operation panel to prevent accidental icon operation by children.





1.  Touch  for about 5 seconds or more when the door is closed (until the buzzer sounds).
 lights up when the setting is finished.
- Setting cannot be changed during Child Safety Lock.







To Cancel

1.  Again, touch  for about 5 seconds or more when the door is closed (until the buzzer sounds).
 goes off when the setting is cancelled.

To Reset Settings

Returns the settings to their initial conditions (at the time of purchase), for example if you have forgotten the settings.

1.  Touch  to light up an icon.
 2.  Touch  for about 10 seconds (until the buzzer sounds twice).
The following settings will be reset.
-  Energy Saving Mode

- Hot Freezing 
- Power Save Mode 
- Supercool Chilling 
- Rapid Ice 
- Supercool Freezing 
- Rapid Cool 

The temperature setting of the versa compartment (Freezing and Soft-Freezing) does not change. The “ICE STOP” setting for ice making will not be reset.

When  Lights Up

When  lights up, the refrigerator is in demonstration mode. The refrigerator does not cool in this mode. Contact the retail store where you purchased the refrigerator, or cancel the demonstration operation with the following procedure.

To Cancel

1. Keep the doors of the versa compartment open.



2.

Light up the icons and press  ,  , and  at the same time for at least 5 seconds.

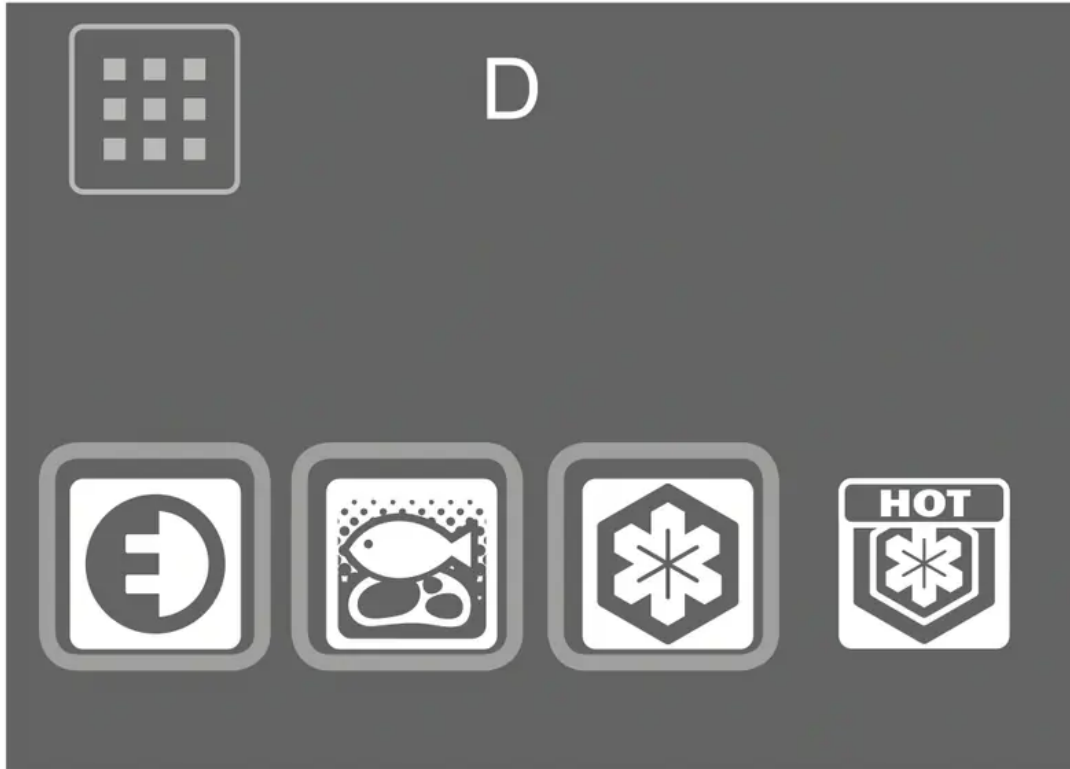

Touch until the buzzer sounds

3.

Check that  is turned off.
The demonstration mode was not cancelled if it lights up.

(Door Alarm,  Mark, When Not Using the Refrigerator for a Long Time)

When the Door Alarm Sounds and the Interior Light of the Refrigerator Compartment Blinks (Door Alarm)

The door alarm (with alarm sound, interior light, and compartment display) is activated when a door is open for 1 minute or longer.

The pattern of the door alarm sound and the action of the interior light and compartment display area are as follows depending on how long the door has been left open.

Time for which the door left open	1 minute	2 minutes	3 minutes	4 minutes	5 minutes or longer	60 minutes or longer
Alarm sound	4 short beeps, then 2 beeps	4 short beeps, then 3 long beeps	4 short beeps, then 4 long beeps	After 4 short beeps, Continuous long beeps	Continuous short beeps	
Interior light	On			Blinks twice per minute	Off	
Compartment display area	The compartment display area will blink in synchronization with the alarm sound					

- Check that the doors are not left ajar or do not have any food trapped (the packing, the back of the drawer cases). (Check at least once a month.)
- All doors have an opening and closing sensor.
- Check the refrigerator compartment door rotating partition.

When the Alarm Cannot be Turned Off

Check that there are no gaps between the door.

When the alarm cannot be turned off, there may be a malfunction and an inspection is required. Contact the retail store where you purchased the refrigerator.

To Stop the Alarm (Continuous Short Beeps)

The alarm can be temporarily stopped in the time before the refrigerator is repaired.



Press  for at least 5 seconds.

* If performing the above operation does not turn off the alarm, or the alarm periodically sounds, check peripheral machinery as well.



When the Mark Blinks Rapidly (About 5 Times per Second)

When the refrigerator will not cool, there may be a malfunction and an inspection is required. Contact the retail store where you purchased the refrigerator.

When Not Using the Refrigerator for a Long Time (When the Power Plug Is Unplugged)

1. Set to the "STOP" ice making mode.

Check that  is lit.

2. Empty any water or ice from the water tank, ice tray, and ice storage box and clean. Wash the water tank, water supply pump, tank pipe, tank cap, lid, water supply pipe, ice storage box, soundproof mat, ice tray and ice server, dry them completely, and then return them to their original positions. Do not dispose of the soundproof mat.
3. Remove the power plug.

4. Clean the interior of the refrigerator and open the doors for 2 to 3 days to dry the inside.
 - * If the refrigerator is not dried sufficiently, it may cause mold, odors, or refrigerant (gas) leaks due to condenser corrosion.

Notice: Wash the water tank, water supply pipe, and ice tray before making ice for the first time, or if you have not made ice for more than a week. Odors or dust may be adhering to the parts.

(To Move or Transport the Refrigerator)

To Transport the Refrigerator

1. Empty any water or ice from the water tank, ice tray, and ice storage box.
2. Wear protective gear (gloves).
3. Remove the adjustable support cover, and then rotate and raise the adjustable supports.
4. Remove the power plug.
5. Lay towels under the drainage port and the lower rear edge of the refrigerator, and position a container or tray with a height of about 3 cm on the towels to collect the water.
 - * The towels prevent floor damage, and water from being spilled on the floor.
6. Tilt the refrigerator slowly to the rear by about 30 degrees, and drain the water from the evaporation tray via the drainage port on the lower rear side. (The evaporation tray is not visible from the outside.)
 - * Because the refrigerator is heavy, the work must be performed by at least 4 people.
 - * The work must not be performed by small children or people who are not capable of doing heavy work. Ask a specialist transportation company.
7. 4 or more people should hold the hand-holds on the bottom and the upper part of the rear side and the hand-holds on the lower inside part of the front side and the upper side of the rear, and carry the refrigerator slowly.
 - Do not lay down the refrigerator on its side. (The compressor may be damaged.)

Drainage port

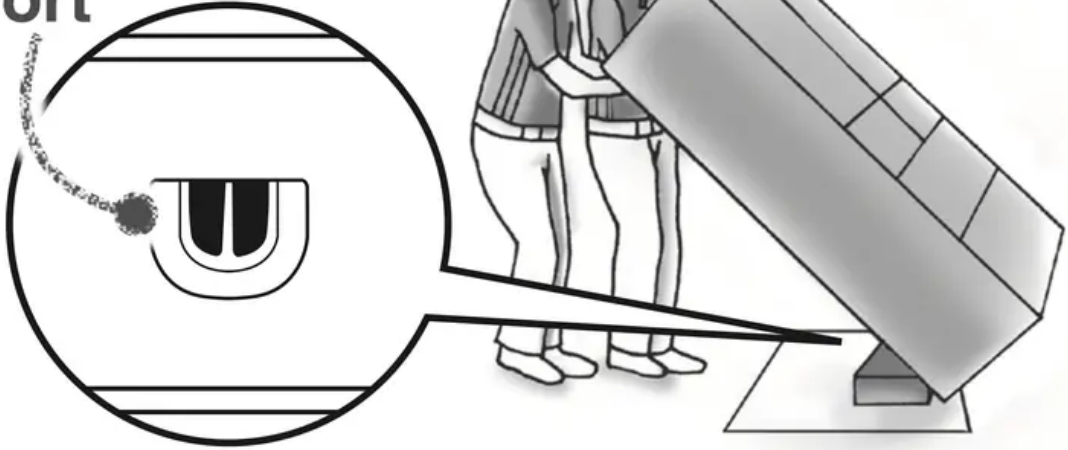

Bottom handles



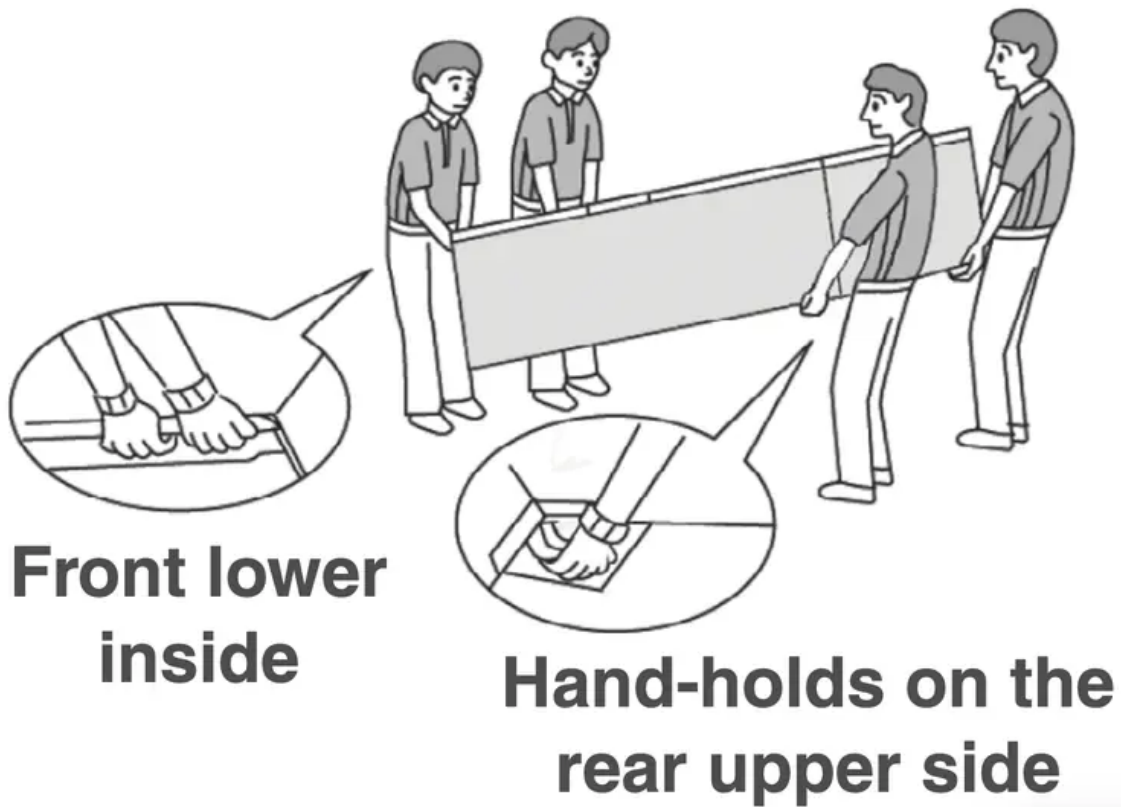

When the Transportation Time Is Long, for Example When Moving House

- Frost from the condenser inside the freezer compartment will melt, and may spill water when the refrigerator is transported.
It may take 1 day to defrost after unplugging the power plug.

Prohibited: Do not damage the refrigerator's refrigerant circuit (pipes). Because combustible refrigerant is used, this may result in fire or an explosion.

Follow the instructions: Wear protective gear when you install the refrigerator. Do not use any tools other than the adjustable support tool kit. Not following these instructions may result in floor damage or injury.

To Move the Refrigerator in Forward and Backward Directions

1. Wear protective gear (gloves).
2. Remove the adjustable support cover, and then rotate and raise the adjustable supports.
3. Lay protective material under the casters and rear supports to prevent damaging the floor.
4. Move the refrigerator in the forward and backward directions.
* Moving in any direction other than forward and backward may damage the floor. Please make sure to lay protective material such as a plate or board on the floor.







(Temperature Fine Adjustment Mode)

To Control the Temperature More Precisely (Temperature Fine Adjustment Mode)

The temperature can be set to 19 different levels for the refrigerator compartment and freezer compartment, while it can be set to 24 different levels for the versa compartment (5 levels when set to Soft-Freezing and 19 different levels for Freezing).

- When temperature fine adjustment mode is set, the compartment display blinks about every 10 seconds.

Setting the Temperature Fine Adjustment Mode

1.  Touch  to light up icons.
2.  Touch  and select the compartment you would like to set to temperature fine adjustment mode.
3.  Touch  for at least 5 seconds (until the buzzer sounds).







- The refrigerator compartment, freezer compartment, and versa compartment can all be set with a single operation.

To Cancel

The same operation as above.

- If the setting is reset, it will be cancelled.

Performing the Temperature Fine Adjustment

1.  Touch  to light up icons.
2.  Touch  to select the compartment to perform temperature fine adjustment.
3.  Repeatedly touch  to perform temperature fine adjustment.

Display Example: When the refrigerator compartment is set to Temperature Setting 5.

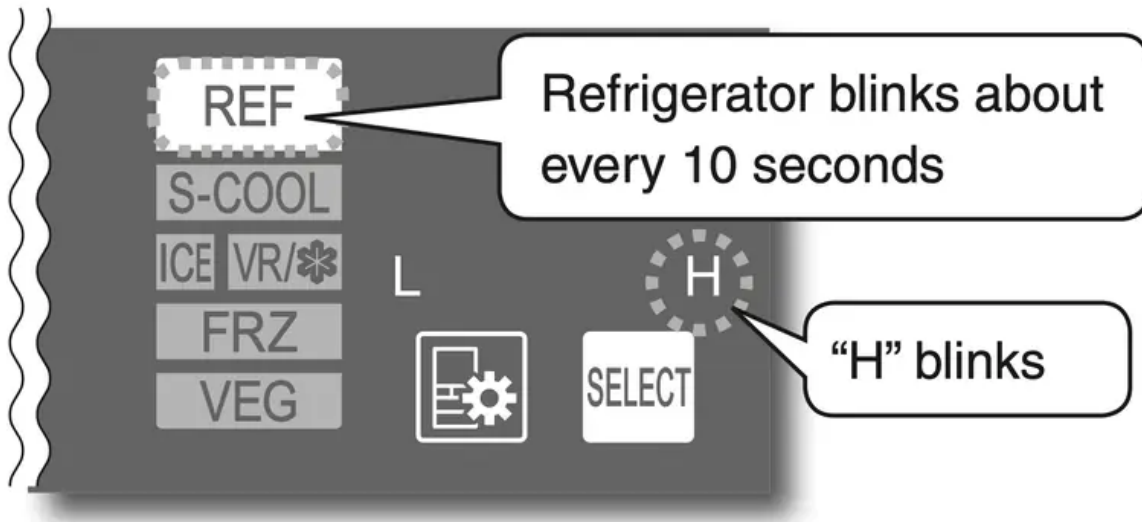

Refrigerator Compartment / Freezer Compartment / Versa Compartment (Freezer Setting)

	Temperature setting						
1	L	8	L •	•	16	•	H
2	L •	9	L •	•	17	M	H
3	L M	10	M		18	•	H
4	L •	11	L •	•	19		H
5	L H	12	•	•			
6	L •	13	M •	H			
7	L • M	14	•	H			
		15	L •	H			

Versa Compartment (Soft-Freezing Setting)



	Temperature setting
1	L
2	L ●
3	M
4	● H
5	H

*  represents a blinking display.

* The versa compartment can be consecutively set to the Soft-Freezing setting and the Freezing Setting.

Notice: If Versa compartment is set as “19” of freezer setting, then the temperature in the Freezer compartment will be automatically set as “10” (“1” to “9” setting will not be available).

Troubleshooting

Before contacting MITSUBISHI ELECTRIC SERVICE CENTRE or its service agent or making a repair request, check the following.

If the problem persists, contact the retail store where you purchased the refrigerator as soon as possible.

Frequently asked questions in the initial period and in summer

The refrigerator does not cool at all!

- The refrigerator takes time to cool when you first start using it. In summer, it may take up to 24 hours for the inside to be fully cooled.
-  is shown on the operation panel, cancel demonstration mode.
- Check if the power plug is disconnected or the circuit breaker has tripped.

The outer walls heat up!

- The outer walls heat up significantly (to about 50 to 60°C) immediately after installation and in summer. This is because the heat discharging and condensation prevention pipes are located on the sides and the top of the refrigerator. They are required for cooling and the heat is not an abnormality.
- The refrigerator compartment rotating partition also has a condensation prevention heater that heats up.
- A heat discharging fan is located under the refrigerator.
A heat discharging fan is located under the refrigerator.

Heat discharging pipe

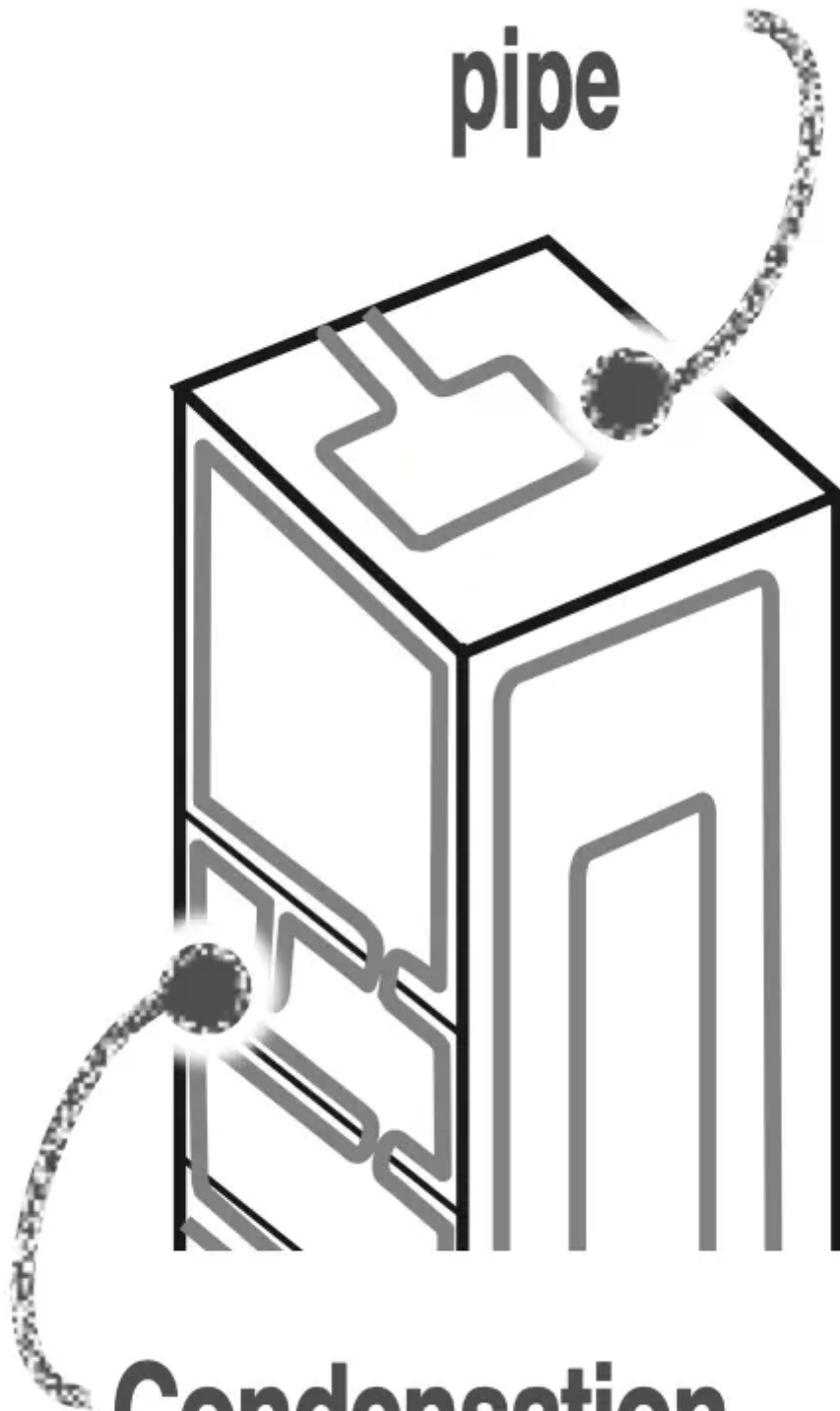

Condensation Prevention Pipes

In Versa Compartment...

Ice cream melts

- For storing ice cream and frozen foods, set to “FRZ” “H”.
Soft-Freezing is set at the time of purchase.

Food does not quickly freeze

- With Soft-Freezing, food freezes at about -7°C , so it may take up to about 24 hours for food to completely freeze.
- Supercool Freezing takes time (about 8 to 9 hours) to uniformly freeze food from the core.

Soft-Freezing freezes food



- Food appears to freeze just as when it freezes in the freezer.

The operation panel turns off automatically!

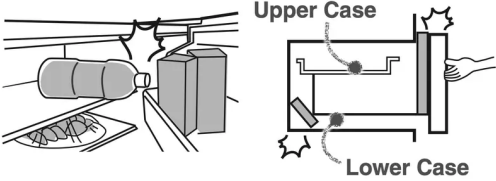

- If 30 seconds pass without any operation panel button operations, the display turns off.

When lighting, touch  .

Problem	Check	Explanation and Action
Cooling Performance		
Does not cool well Ice melts	Has enough time passed after installation?	It takes 4 to 5 hours for the refrigerator to cool, and may take 24 hours in summer to fully cool.
	Is the temperature setting set to "L"? Is the compartment set to Power Save Mode?	Set to "M" or "H", or set the versa compartment to "FRZ•H" or to the setting of your liking. Cancel Power Save Mode.
	Is the flow of cold air being blocked? Are the doors being opened frequently, or left ajar? Is food blocking them?	Make space between foods and remove any food that is sticking out of shelves or touching the ceiling of the drawers. Avoid opening and shutting the door for a while. 
	Is heat discharging being blocked? Check if there is no gap around the refrigerator and the refrigerator is exposed to direct sunlight.	Check that there is enough space around the refrigerator and that it is properly installed.
Food freezes in the refrigerator and vegetable compartments	Is the temperature on the operation panel set to "H"?	Set the temperature to "M". Also, the temperature with each setting may temporarily decrease.
	Is food with a lot of moisture stored at the rear of the shelf?	Place drinks and food containing a lot of water, such as tofu, vegetables and fruits, at the front of the shelf or in a door pocket. Low-fat and low-sugar foods are likely to

Problem	Check	Explanation and Action
		freeze easily when they are stored at the rear of the shelf.
	Is the surrounding temperature 5°C or less?	Food in the refrigerator compartment or vegetable compartment may freeze. Freezing is less likely when the temperature settings are set to “L”.
	Is the water supply pipe installed correctly without any gaps or looseness?	If there are foreign objects loosening the pipe or if there is a gap, strong cold air can flow into the refrigerator compartment. Make sure that it is securely set.
<p>Overcooling in the freezer compartment, though the temperature setting of freezer compartment is</p> <p>set to “” or “.</p>	Is the temperature setting of versa compartment set to “FRZ•H”?	Set the temperature of versa compartment to “FRZ•L” or “FRZ•M”.
<p>Supercool Chilling</p>		
<p>Food in the lower case freezes</p>	Is the lower case set to Supercool Chilling?	<p>Perform the Supercool Chilling setting. At the time of purchase, the lower case is not set to Supercool Chilling.</p> 
	Is the surrounding temperature 5°C or less?	Set the temperature of the lower case (when Supercool Chilling is set) to “L”.

Problem	Check	Explanation and Action
	Is the refrigerator compartment's temperature set to "H"?	Set the temperature of the refrigerator compartment to "M" or "L", or set the temperature of the lower case (when Supercool Chilling is set) to "L".
	Have you placed easily frozen food containing a considerable amount of moisture in the compartment?	Place food containing a lot of water at the front of the refrigerator compartment or in a door pocket. Low-fat and low-sugar foods are likely to freeze easily when they are stored at the rear of the shelf.
	Are you piling frozen food onto other food?	Food that touches frozen food may freeze.
The lower case does not cool	Is a high temperature set for the refrigerator compartment?	Set the temperature of refrigerator compartment to "M" or "H".
	Is the flow of cold air being blocked?	Do not block the area near the air outlet with food. Also, do not stack items higher than the case.
	Has the Supercool Chilling been set?	Set the Supercool Chilling. At the time of purchase, the lower case is not set to Supercool Chilling. 
	Set the lower case compartment temperature?	In order to store the food at Supercool Chilling without freezing it, the compartment temperature may rise temporarily.

Problem	Check	Explanation and Action
Versa Compartment		
Food in the versa compartment melts	When storing ice cream and frozen foods, did you set the refrigerator to “FRZ•H”?	“SOFT FRZ”, “FRZ•L”, and “FRZ•M” are higher temperature settings. Set to “FRZ•H”.
	Did you set Hot Freezing after placing hot food inside? 	When placing hot food in the compartment, use Hot Freezing. 
	Is the versa compartment set to Power Save Mode?	Cancel Power Save Mode.
	When placing hot food in the compartment, did you place it away from other food?	Frozen food may thaw if it makes contact with hot food. Leave space.
	Is food piled up in the upper area?	Leave a gap so that cold air can flow to the ceiling and between food.
	Has enough time passed after installation?	The refrigerator takes time to cool completely.
Soft-Freezing freezes food too hard	Is the versa compartment set to “FRZ”?	Set the versa compartment to “SOFT FRZ”.
	Does the food contain a lot of moisture?	Foods containing a considerable amount of moisture may freeze too hard. We recommend leaving the food for about 5 to



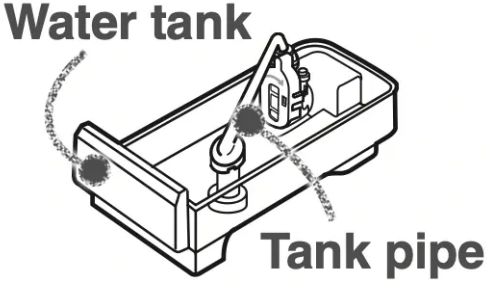

Problem	Check	Explanation and Action
		15 minutes, placing the other hand on the back of a knife, and cutting the food by pushing on it. Also, use the setting "SOFT FRZ•L".
	Is food freezing the same way as with "Freezing"?	Food appears to freeze in the same way as with "Freezing".
Automatic Ice Making		
Cannot make ice Water in the tank stays at the same level	Has enough time passed after installation?	It takes 4 to 5 hours for the refrigerator to cool, and 24 hours or more in summer to make ice.
	Has food, the ice server, or another object been left in the ice storage box? Also, has the ice been leveled?	Remove food or other objects from the ice storage box. The ice storage box is judged to be full of ice. Also, spread the ice out flat all the way to the front.
	Is the ice making setting for the ice making compartment set to "ICE STOP"?	Set the ice making compartment's setting to 
	Are the ice tray and ice tray lock lever installed correctly?	Set the ice tray lock lever to the correct position and check the installation status of the ice tray.
	Is the water supply pipe installed correctly in the tank holder area?	Remove any foreign objects creating gaps and install the pipe so that it is not loose.
	Are the water supply pump and tank pipe	Check that they are correctly installed. In particular, ensure that the opening of the

Problem	Check	Explanation and Action
	installed correctly onto the water tank?	tank pipe inside the tank is installed firmly to the tank.
Makes only a small amount of ice Making ice takes a long time	Is the door opened or the ice tray removed frequently?	Ice making takes longer. Do not open and close the door or remove the ice tray frequently.
	Is the temperature of the freezer compartment set to "L"? Is the energy saving mode set for the freezer compartment?	Making ice may take longer. Set the temperature of the freezer compartment to "M", and cancel energy saving mode.
Water tank or water supply pipe freezes	Are the water supply pipe and water tank installed to the refrigerator without any gaps? Additionally, is the tank pipe installed to the water tank without any internal gaps?	Check the installation around the water tank. If there are gaps, the cold air may escape and water may freeze. <div style="text-align: center;">  </div>
Ice is small or joined together	Has ice been stored inside the ice storage box for a long time?	Ice stored inside the ice storage box for a long time may shrink or join together (due to a phenomenon called sublimation). When not using ice, it is recommended that you remove the water and stop the ice making.
	Does it occur when the water in the water tank is decreasing?	As the water in the water tank decreases, the amount of supply water is slightly reduced.
Sound		

Problem	Check	Explanation and Action
There is a rattling sound	Are any nearby objects in contact with the refrigerator?	Leave space around the refrigerator. When objects or walls are in contact with the refrigerator, sounds may be heard.
	Make sure that the water tank and water supply pipe are properly installed.	Push in the water tank until it touches the rear side. If it is out of position, the sound of the water supply pipe can grow loud. If there are any gaps or looseness, the water may freeze, causing sounds to be heard.
Loud noises Worrisome noises (Noises described on the right are normal)	The noise gets louder suddenly or the tone changes.	Immediately after beginning use, when the weather is hot, when the doors are frequently opened and closed, and in similar situations, the refrigerator switches to high-speed operation and cools with high power.
	A whistling sound is made after closing a door.	This is the sound of the cooling fan motor starting.
	A whipping or dripping sound is sometimes heard from inside the refrigerator after a door is opened.	This is the creaking sound as warm air enters and expands the plastic.
	Sometimes the sound of flowing or boiling water can be heard.	This is the sound of the refrigerant (gas) flowing.
	A rattling or squeaking sound is made sometimes (every 1 to 2 hours).	This is the sound of the automatic ice maker. Even when there is no water in the water tank, the automatic ice maker and pump make a sound about every 100 minutes.

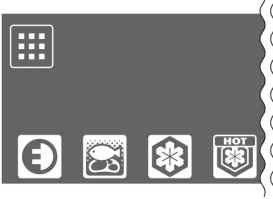
Problem	Check	Explanation and Action
	<p>After turning on the power, a thumping or creaking sound may be heard in the ice making “ICE STOP” mode (every 1 to 2 hours).</p>	<p>This is the sound of the operation check. The check is performed even in the “ICE STOP” ice making mode.</p>
<p>Doors do not close Doors open easily</p>	<p>Is a door making contact with food or a case? Is too much food packed inside?</p>	<p>Store food so that the door does not make contact with the food when closed. In the refrigerator compartment, store food on the shelves and in the drawer doors store food so that it does not make contact with the ceiling when doors are shut and opened. Do not attach a case that you purchased separately onto the outside of a pocket.</p>
	<p>Has food fallen behind a case in a drawer door, or is the power cord or another object trapped between the refrigerator and a door?</p>	<p>Remove any objects. Make sure that the door does not trap objects such as food, power cords or plastic bags.</p>
	<p>Is the refrigerator installed stably? Are the adjustable supports making contact with the floor?</p>	<p>Lower the adjustable supports to raise the front side slightly and make the doors easier to close.</p>
<p>The alarm will sound</p>	<p>Check if the doors are closed.</p>	<p>Refer to “When the door alarm sounds” and “When the alarm cannot be turned off”.</p>
<p>Operation Panel</p>		



Problem	Check	Explanation and Action
<p>The operation panel does not respond</p> 	<p>Is  lit?</p>	<p>Cancel the Child Safety Lock.</p>
	<p>Are the user's fingers or the operation panel wet or dirty?</p>	<p>Wipe off the moisture and dirt on the operation panel and fingers.</p>
	<p>Are you repeatedly touching it?</p>	<p>Let your finger off the operation panel once and then touch it again. It will respond when you let you finger off.</p>
	<p>Are seals and tapes put on the operation panel?</p>	<p>Remove the seals and tapes.</p>
<p>Reacts without a touch</p>	<p>Are there any towels, plastic bags, papers, etc. over the operation panel?</p>	<p>Remove the towel, plastic bag, paper, etc.</p>
<p>Some icons do not light up</p>	<p>Is it set to Power Save Mode?</p>	<p>The icons that cannot be set during Power Save Mode are off.</p>
<p> is blinking and won't go off</p>	<p>Is the ice tray lock lever not locked?</p>	<p>If you release the ice tray lock lever while the ice tray is operating,  will blink. Lock the ice tray lock lever and close the ice making compartment's door.</p>
<p>There are no longer 3 ★ marks lighted on the power saving monitor.</p>	<p>Has the temperature setting been modified?</p>	<p>Setting each compartment to "H" will lower the power saving level.</p>
	<p>Is there any increase in the time the door is left open or the amount of food, or a rise in the compartment temperature?</p>	<p>More energy is used in cooling, resulting in a lowered power saving level.</p>

Problem	Check	Explanation and Action
Condensation/ Frost		
<p>Condensation forms on the outer walls and inside the refrigerator</p> <p>Frost forms in the freezer compartment</p> <p>Water drips onto the floor</p>	<p>Are the doors being opened frequently, or are there any gaps?</p>	<p>Close the doors so that there are no gaps.</p> <p>When moisture in the air cools, it forms frost or condensation.</p> <p>When there is high humidity, condensation or frost will form even in very small gaps.</p> <p>Regarding the Vegetable Compartment</p>
	<p>Is the humidity high, for example is it raining?</p>	<p>Condensation may form temporarily. Wipe off with a dry cloth. Condensation may cause frost to form in the freezer compartment. Please minimize the time when doors are kept open.</p>
Others		
<p>There are lines like scratches on the clear parts</p>	<p>Is it a thin line without level difference on its both sides?</p>	<p>This is a mark created at the time the plastic is molded. It is created at the joint where resin flows. This is not a flaw.</p>
<p>There are holes in the door and the refrigerator walls</p>	<p>Are there small holes in the door or in the refrigerator walls?</p>	<p>These are holes that let air escape for the injection of foam heat insulating materials in the manufacturing process. These are not flaws or abnormalities.</p>
<p>The surface of the sides or doors is warped</p>	<p>Does the light reflected on the surface appear distorted?</p>	<p>Warping and surface waviness occurs in the manufacturing process. When light hits the surface, it may appear warped, but this is not an abnormality.</p>
<p>Noise interferes with televisions or other devices</p>	<p>Is the refrigerator installed near an electronic device such as a television?</p>	<p>Install the refrigerator away from electronic devices such as televisions.</p>



Problem	Check	Explanation and Action
	Is the power to the refrigerator supplied from a socket near the entry hole of the antenna cable?	Use separate power. When using a 2 pin plug, use grounding.
There is a bothersome smell (Food / Ice)	Have you placed food with strong odor inside the refrigerator without sealing it in a container?	Store food with strong odor in packaging. The odor may not be removed with a deodorizing apparatus.
	Do you periodically clean the water tank?	Clean periodically.
The adjustable support cover comes off.	Are the adjustable supports touching the floor?	When the adjustable supports are raised, the adjustable support cover cannot be inserted fully. Turn the adjustable supports to lower the refrigerator until the supports touch the floor.
	Is the adjustable support cover fully inserted?	Open the door of the vegetable compartment and insert the adjustable support cover into the refrigerator while checking it from above.

Warning

This content is compiled from multiple sources and is provided for reference purposes only. It may not be complete or fully applicable to all situations. If you are unable to resolve your issue, please contact the product manufacturer or an authorized service provider for official support.