

## USING THE OVEN

### Oven Controls

#### Single Wall Oven

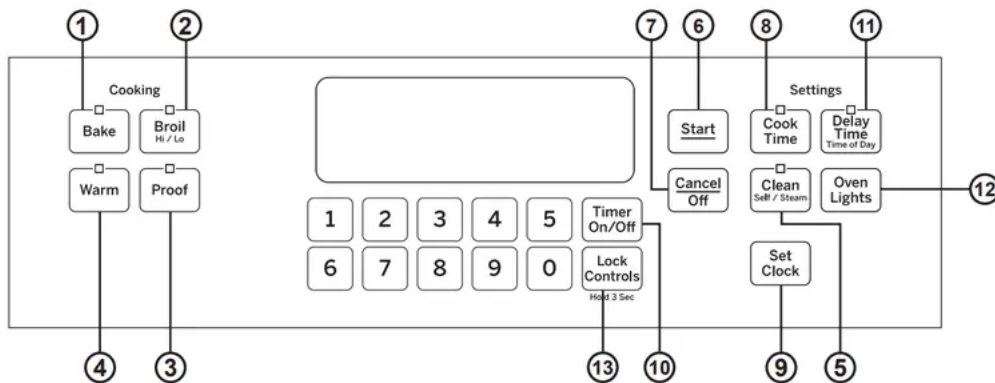

1. **Bake:** Touch this pad to select the bake function. See the Cooking Modes section for more information.
2. **Broil:** Touch this pad to select the broil function. See the Cooking Modes section for more information.
3. **Proof:** Helps yeast bread rise. See the Cooking Modes section for more information.
4. **Warm:** Keeps hot food warm. See the Cooking Modes section for more information.
5. **Clean:** Your oven has two cleaning modes: Self Clean and Steam Clean. See the Cleaning the Oven section for important information about using these modes.
6. **Start:** Must be pressed to start any cooking, cleaning, or timed function.
7. **Cancel/Off:** Cancel ALL oven operation except the clock and timer
8. **Cook Time:** Counts down cooking time and turns off the oven when the cooking time is complete. Press the **Cook Time** pad, use the number pads to program a cooking time in hours and minutes, then press **Start**.
9. **Clock:** Press the **Set Clock** pad and the number pads to program the clock. Press **Start** to save the time.
10. **Timer:** Works as a countdown timer. Press the **Timer** pad and the number pads to program the time in hours and minutes. Press the **Start** pad.
  - The oven will continue to operate when the timer countdown is complete. To turn the timer off press the **Timer** pad

11. **Delay Time:** Delays when the oven will turn on. Use this to set a time when you want the oven to start. Press the **Delay Time** pad and use the number pads to program the time of day for the oven to turn on then press **Start**. Press the desired cooking mode and temperature then press **Start**. A cook time may also be programmed if desired. Follow the directions under Cook Time for setting this feature. This can only be used with Bake and Self-Clean.

- **NOTE:** When using the delay time feature, foods that spoil easily—such as milk, eggs, fish, stuffings, poultry and pork—should not be allowed to sit for more than 1 hour before or after cooking. Room temperature promotes the growth of harmful bacteria. Be sure that the oven light is off because heat from the bulb will speed harmful bacteria growth.

12. **Oven Light(s):** Turns the oven light(s) on or off.

13. **Lock Controls:** Locks out the control so that pressing the pads does not activate the controls. Press and hold the Lock Controls pad for three seconds to lock or unlock the control. Cancel/Off is always active, even when the control is locked.

### Double Wall Oven

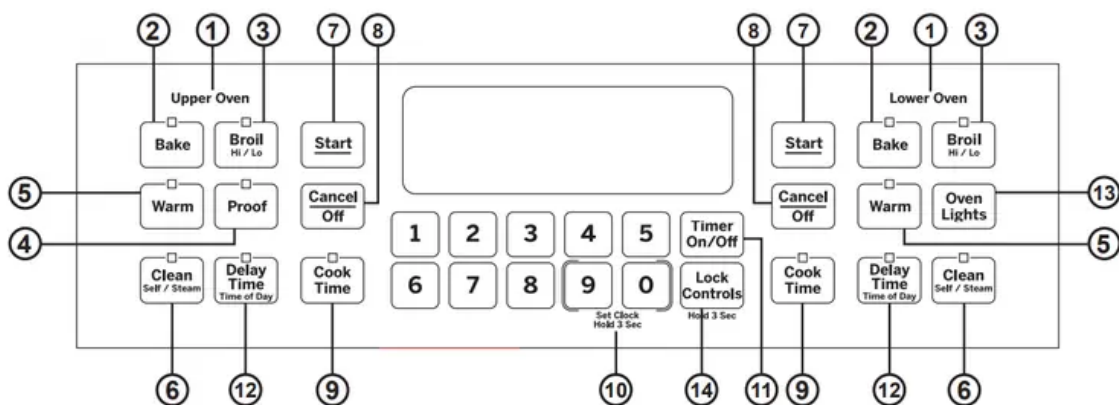

1. Upper Oven and Lower Oven: Designates which oven the controls will operate.
2. Bake: Touch this pad to select the bake function. See the Cooking Modes section for more information.
3. Broil: Touch this pad to select the broil function. See the Cooking Modes section for more information.
4. Proof: Helps yeast bread rise. See the Cooking Modes section for more information. Note that proof cannot be run when running a clean mode in the lower oven.
5. Warm: Keeps hot food warm. See the Cooking Modes section for more information.
6. Clean: Your oven has two cleaning modes: Self Clean and Steam Clean. See the Cleaning the Oven section for important information about using these modes. Note that proof cannot be run when running a clean mode in the lower oven.
7. Start: Must be pressed to start any cooking, cleaning, or timed function.

8. **Cancel/Off:** Cancels ALL oven operations except the clock and timer.
9. **Cook Time:** Counts down cooking time and turns off the oven when the cooking time is complete. Press the Cook Time pad, use the number pads to program a cooking time in hours and minutes, then press Start.
10. **Clock:** Sets the oven clock time. Press the 9 and 0 pads and hold for 3 seconds. Use the number pads to program the clock. Press Start to save the time.
11. **Timer:** Works as a countdown timer. Press the Timer pad and the number pads to program the time in hours and minutes. Press the Start pad.  
The oven will continue to operate when the timer countdown is complete. To turn the timer off press the Timer pad.
12. **Delay Time:** Delays when the oven will turn on. Use this to set a time when you want the oven to start. Press the Delay Time pad and use the number pads to program the time of day for the oven to turn on then press Start. Press the desired cooking mode and temperature then press Start. A cook time may also be programmed if desired. Follow the directions under Cook Time for setting this feature. This can only be used with Bake and Self-Clean.
  - **NOTE:** When using the delay time feature, foods that spoil easily—such as milk, eggs, fish, stuffings, poultry and pork—should not be allowed to sit for more than 1 hour before or after cooking. Room temperature promotes the growth of harmful bacteria. Be sure that the oven light is off because heat from the bulb will speed harmful bacteria growth.
13. **Oven Light(s):** Turns the oven light(s) on or off in both ovens. Note that lights in both ovens will not turn on if the door is opened while the other oven is in a clean mode.
14. **Lock Controls:** Locks out the control so that pressing the pads does not activate the controls. Press and hold the Lock Controls pad for three seconds to lock or unlock the control. Cancel/Off is always active, even when the control is locked.

## **Special Features**

There are several different special features on your wall oven. To change the settings of these special features, press the BAKE and BROIL pads at the same time and hold for three seconds. "SF" will appear in the display. Select the feature you want to change. When the change has been made, press the START key to save the change and return to the time of day.

### **Adjust the Oven Temperature**

This feature allows the oven baking temperature to be adjusted up to 35°F hotter or down to 35°F cooler. Use this feature if you believe your oven temperature is too hot or too cold and wish to change it. For double oven models, the upper and lower ovens are adjusted separately.

Press the Bake pad to select the oven to be adjusted. Press the Bake pad again to enter the temperature adjustment mode. A number between 35 and - 35 will display. Use the number pads to set the desired temperature adjustment and use the Bake pad to change between negative and positive.

Press the Start pad to save the temperature adjustment.

### **End of Timer Signals**

This is the tone that signals the end of a timer. The tone can be continuous (Con bEEP) or one repeating beep (bEEP). A continuous setting will continue to sound a tone until a button on the control is pressed. Press the Broil pad to view the current setting and then to change the setting.

### **Fahrenheit or Celsius Temperature Display**

The oven control is set to use Fahrenheit temperatures (F), but you can change it to use Celsius temperatures (C). Press the Broil and Cook Time pads at the same time to view the current setting, press again to change the setting.

### **Clock Display**

This feature specifies how the time of day will be displayed or if no time of day will be displayed. You can select a standard 12-hour clock (12 H), 24-hour military time display (24 H), or no clock displayed (oFF). Press the Clock pad to view the current setting, press again to change the setting.

### **Sound Volume**

This feature allows the oven tone volume to be adjusted between high (HI bEEP HI), medium (Std bEEP Std), low (Lo bEEP Lo) and off (oFF bEEP oFF). Press the Cook Time pad to view the current setting or to change the setting. The control will sound the oven tone at the new volume level each time the sound level is changed.

### **12-hour auto shut-off and Sabbath**

Options for this feature are "12 SHdn", "no SHdn" and "SAbbAtH".

12-hour auto shut-off turns off the oven after 12 hours of continuous operations.

Sabbath mode disables the oven lights (the oven light will not turn on when the door is opened), all sounds (the control will not beep when a button is pressed), Broil, Warm, Proof, Cook Time, Timer, Clock, and Delay Time functions. Sabbath mode can only be used with Bake. This feature conforms to the Star-K Jewish Sabbath requirements.

Press and hold the Bake and Broil pads for 3 seconds to enter special features.

Press the Delay Time pad to view the current setting and then to change the setting.

To use Sabbath mode, select "SAbbAtH" and press Start. A ] will appear in the display and the clock will not display.

Note that if you have a double wall oven, when you place the control into Sabbath mode, both ovens are now in Sabbath mode and available for cooking.

Once in Sabbath mode, at any time you can press Bake, use the number pads to enter a temperature between 170F and 550F, and press Start. No sound will be given when the keys are pressed. At a random time between 30 seconds and 1 minute, **⏸**, will appear in the display indicating the oven is running.

If you need to adjust the temperature, press Bake, use the number pads to enter a new temperature between 170F and 550F, and press Start.

To turn the oven off, press Cancel/Off at any time. The oven will immediately turn off and **⏸** will change to **]** indicating that the oven has turned off.

Note that each oven of a double wall oven must be turned off separately.

To exit Sabbath mode, make sure that the oven is turned off. Press and hold the Bake and Broil pads for 3 seconds to enter special features then press Delay Time until either “12 Shdn” or “no Shdn” is in the display and press Start.

**NOTE:** If power outage occurs during Sabbath mode the unit will remain in Sabbath mode but off when power is restored.

If you wish to use the Cook Time feature to bake in the oven and then have the oven automatically turn off, you will need to press the Cook Time button, enter a cooking time duration, and press Start. Then enter special features to start Sabbath mode as detailed above.

## Oven Racks

Your oven has six rack positions. Recommended rack positions for various types of foods are provided in the Cooking Guide. Adjusting rack position is one way to impact cooking results. For example, if you would prefer darker tops on cakes, muffins, or cookies, try moving food one rack position higher. If you find foods are too brown on top try moving them down next time.

When baking with multiple pans and on multiple racks, ensure there is sufficient space between pans to allow air to flow.

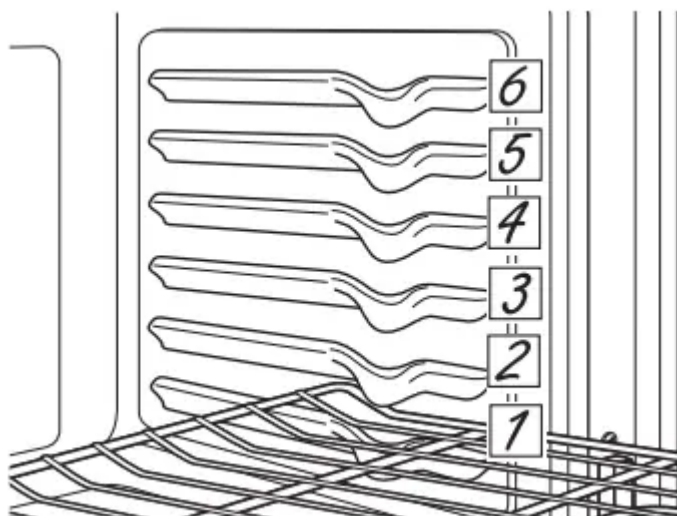

## Flat Racks

When placing and removing cookware, pull the rack out to the bump (stop position) on the rack support.

To remove a rack, pull it toward you, tilt the front end up and pull it out.

To replace, place the curved end of the rack (stop-locks) onto the oven supports, tilt up the front of the rack and push the rack in.

Racks may become difficult to slide, especially after a self-clean. Put some vegetable oil on a soft cloth or paper towel and rub onto the left and right edges.

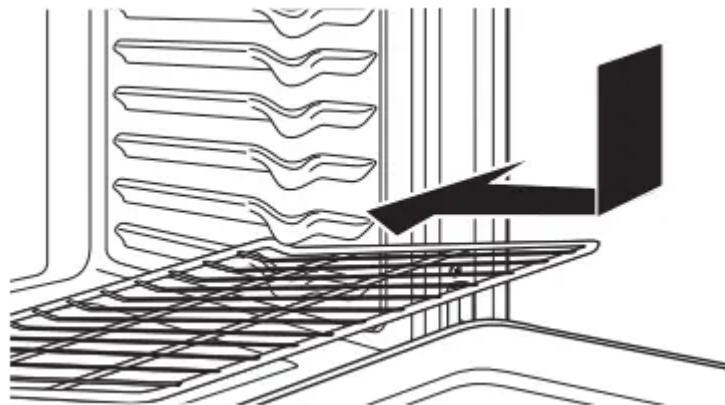
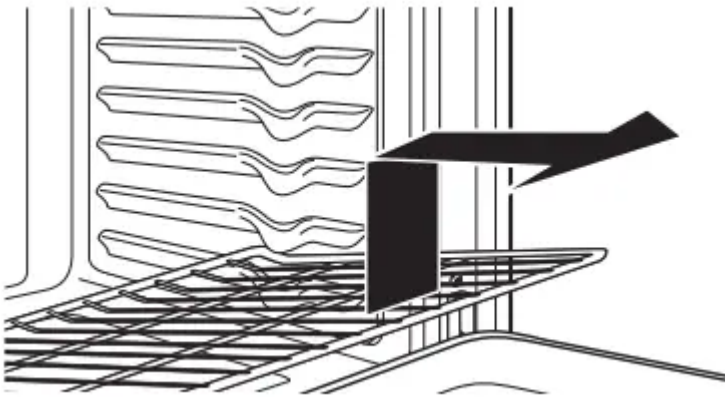

## Aluminum Foil and Oven Liners

**CAUTION:** Do not use any type of foil or oven liner to cover the oven bottom. These items can trap heat or melt, resulting in damage to the product and risk of shock, smoke or fire. Damage from improper use of these items is not covered by the product warranty.

## Cookware

### Cookware Guidelines

The material, finish, and size of cookware affect baking performance.

Dark, coated and dull pans absorb heat more readily than light, shiny pans. Pans that absorb heat more readily can result in a browner, crisper, and thicker crust. If using dark and coated cookware check food earlier than minimum cook time. If undesirable results are obtained with this type of cookware consider reducing oven temperature by 25° F next time.

Shiny pans can produce more evenly cooked baked goods such as cakes and cookies.

Glass and ceramic pans heat slowly but retain heat well. These types of pans work well for dishes such as pies and custards.

Air insulated pans heat slowly and can reduce bottom browning. Keep cookware clean to promote even heating.

## **Cooking Modes**

Your new oven has a variety of cooking modes to help you get the best results. These modes are described below. Refer to the Cooking Guide section for recommendations for specific foods. Remember, your new oven may perform differently than the oven it is replacing.

### **Bake**

The bake mode is for baking and roasting. This mode uses heat primarily from the lower element but also from the upper element to cook food. When preparing baked goods such as cakes, cookies, and pastries always preheat the oven first. Follow recipe recommendations for food placement. If no guidelines are provided center food in the oven. To use this mode press the Bake pad, enter a temperature, and then press Start.

### **Proof**

Proof mode is designed for rising (fermenting and proofing) bread doughs. Press the Proof pad and then press Start. Cover dough well to prevent drying out. Bread will rise more rapidly than at room temperature. Note that for double wall ovens, proof can not be run when running a clean mode in the lower oven.

### **Warm**

Warm mode is designed to keep hot foods hot for up to 3 hours. To use this mode, press the Warm pad then press Start. Cover foods that need to remain moist and do not cover foods that should be crisp. Preheating is not required. Do not use warm to heat cold food other than crisping crackers, chips or dry cereal. It is also recommended that food not be kept warm for more than 2 hours.

## **Broiling Modes**

Always broil with the door closed. The broil element in this oven is very powerful. Monitor food closely while broiling. Use caution when broiling on upper rack positions as placing food closer to the broil element increases smoking, spattering, and the possibility of fats igniting. For best performance center food below the broil heating element. Broiling on rack position 6 is not recommended.

Try broiling foods that you would normally grill. Adjust rack positions to adjust the intensity of the

heat to the food. Place foods closer to the broil element when a seared surface and rare interior is desired. Thicker foods and foods that need to be cooked through should be broiled on a rack position farther from the broiler or by using Broil Lo.

### Broil Hi

The Broil Hi mode uses intense heat from the upper element to sear foods. Use Broil Hi for thinner cuts of meat and/or foods you prefer less done on the interior. To use this mode press the Broil pad once and then press Start. It is not necessary to preheat when using this mode.

### Broil Lo

The Broil Lo mode uses less intense heat from the upper element to cook food thoroughly while also producing surface browning. Use Broil Lo for thicker cuts of meat and/or foods that you would like cooked all the way through. To use this mode press the Broil pad twice and then press Start. It is not necessary to preheat when using this mode.

## Cooking Guide

FOOD TYPE	RECOMMENDED MODE(S)	RECOMMENDED RACK POSITION(S)	ADDITIONAL SUGGESTIONS
<b>Baked Goods</b>			
Layer cakes, sheet cakes, bundt cakes, muffins, quick breads on a Single Rack	Bake	3	Use shiny cookware.
Layer cakes* on Multiple Racks	Bake	2 and 4	Ensure adequate airflow (see illustration below).
Chiffon cakes (angel food)	Bake	1	Use shiny cookware.
Cookies, biscuits, scones on a Single Rack	Bake	3	Use shiny cookware.
Cookies, biscuits, scones on Multiple Racks	Bake	2 and 4	For foods like sugar cookies, switch food location partially through cooking for more even cooking results between racks. Ensure adequate airflow.
<b>Beef &amp; Pork</b>			
Hamburgers	Broil Hi	5	Use a broil pan; move food down for more doneness/less searing. Watch food closely when broiling. For best performance center food below the broil heating element.
Steaks & Chops	Broil Hi	5	Use a broil pan; move food down for more doneness/less searing. Watch food closely when broiling. For best performance center food below the broil heating element.
Roasts	Bake	2 or 3	Leave uncovered, use a low sided pan such as a broil pan. Preheating is not necessary.
<b>Poultry</b>			
Whole chicken	Bake	2 or 3	Use a low sided pan such as a broil pan.
Bone-in chicken breasts, legs, thighs	Broil Hi	1	If breaded or coated in sauce avoid Broil Hi modes. Broil skin side down first. Watch food closely when broiling. For best performance when broiling, center food below the broil heating element.
	Broil Lo Bake	3	
Boneless chicken breasts	Broil Lo Bake	1 (broil) or 3	Move food down for more doneness/less searing and up for greater searing/browning when broiling. For best performance when broiling, center food below the broil heating element.
Whole turkey	Bake	1 or 2	Use a low sided pan such as a broil pan.
Turkey Breast	Bake	2 or 3	Use a low sided pan such as a broil pan.
<b>Fish</b>	Broil Lo	5 (1/2 thick or less) 4 (>1/2 inch)	Watch food closely when broiling. For best performance center food below the broil heating element.
<b>Casseroles</b>	Bake	3	

Frozen Convenience Foods			
Pizza, french fries, tator tots, chicken nuggets, appetizers on a Single Rack	Bake	3	Use shiny cookware.
Pizza, french fries, tator tots, chicken nuggets, appetizers on Multiple Racks	Bake	2 and 4	Use shiny cookware. Switch food location partially through cooking for more even cooking results.

\*When baking four cake layers at a time, use racks 2 and 4. Place the pans as shown so that one pan is not directly above another.

Cook food thoroughly to help protect against food borne illness. Minimum safe food temperature recommendations for food safety can be found at [www.IsItDoneYet.gov](http://www.IsItDoneYet.gov). Make sure to use a food thermometer to take food temperatures.

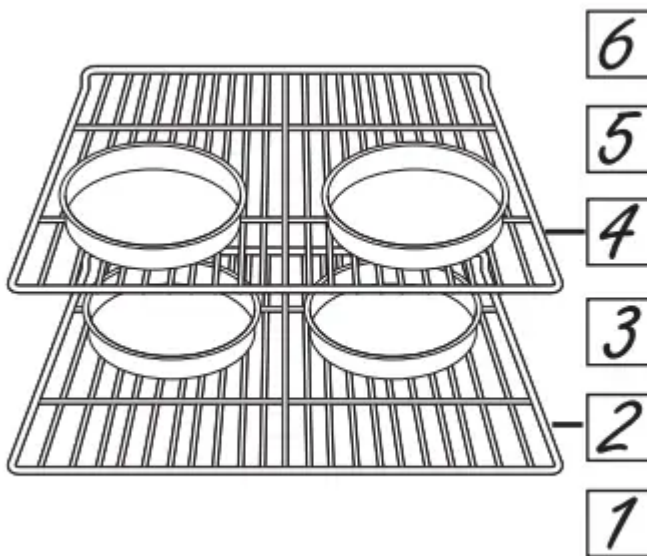

## CARE AND CLEANING

### Cleaning The Oven

Be sure electrical power is off and all surfaces are cool before cleaning any part of the oven.

#### Control Panel

It's a good idea to wipe the control panel after each use. Clean with mild soap and water or vinegar and water, rinse with clean water and polish dry with a soft cloth.

Do not use abrasive cleansers, strong liquid cleansers plastic scouring pads or oven cleaners on the control panel—they will damage the finish.

#### Oven Exterior

Do not use oven cleaners, abrasive cleansers, strong liquid cleansers, steel wool, plastic scouring pads, or cleaning powders on the interior or exterior of the oven. Clean with a mild soap and water

or vinegar and water solution. Rinse with clean water and dry with a soft cloth. When cleaning surfaces, make sure that they are at room temperature and not in direct sunlight.

If stain on the door vent trim is persistent, use a mild abrasive cleaner and a sponge-scrubber for best results. Spillage of marinades, fruit juices, tomato sauces and basting liquids containing acids may cause discoloration and should be wiped up immediately. Let hot surfaces cool, then clean and rinse.

### **Stainless Steel Surfaces (on some models)**

Do not use a steel wool pad; it will scratch the surface. To clean the stainless steel surface, use warm sudsy water or a stainless steel cleaner or polish. Always wipe the surface in the direction of the grain. Follow the cleaner instructions for cleaning the stainless steel surface.

To inquire about purchasing cleaning products including stainless steel appliance cleaner or polish read the Assistance and Accessories sections at the beginning of this manual.

### **Oven Interior**

The interior of your new oven can be cleaned manually or by using the Steam Clean or Self Clean modes. Spillage of marinades, fruit juices, tomato sauces and basting liquids containing acids may cause discoloration and should be wiped up immediately. Let hot surfaces cool, then clean and rinse.

### **Manual Cleaning**

Do not use oven cleaners, abrasive cleaners, strong liquid cleansers, steel wool, scouring pads, or cleaning powders on the interior of the oven. Clean with a mild soap and water or vinegar and water solution. Rinse with clean water and dry with a soft cloth. When cleaning surfaces, make sure that they are at room temperature.

### **Steam Clean Mode**

Steam clean is intended to clean small spills using water and a lower cleaning temperature than Self-Clean.

To use the Steam Clean feature, wipe grease and soils from the oven. Pour one cup of water into the bottom of the oven. Close the door. Press the Clean pad twice and then press Start. The oven door will lock. You can not open the door during the 30 minute steam clean as this will decrease the steam clean performance. At the end of the steam clean cycle the door will unlock. Wipe out any excess water and any remaining soil.

### **Self Clean Mode**

Read Self-Cleaning Oven Safety Instructions at the beginning of this manual before using Self Clean Mode. Self clean uses very high temperatures to clean the oven interior. The oven door will lock when using this feature. Before operating the self-clean cycle, wipe up grease and soils from the oven. Remove all items from the oven other than enameled (dark color) racks. Shiny or silver racks and any cookware or other items should all be removed from the oven before initiating a self-

clean cycle. Close the door. Press the Clean pad once and a default selfclean time is displayed. The clean time can be changed to any time between 3:00 and 5:00 hours by using the number pads to enter a different time and pressing Start. For heavily soiled ovens, the maximum 5 hour clean time is recommended. If you wish to use the default time, press the Start pad immediately after pressing the Clean pad. The oven will turn off automatically when the self-clean cycle is complete. The door will stay locked until the oven has cooled down. After the oven has cooled down wipe any ash out of the oven.

**IMPORTANT:** The health of some birds is extremely sensitive to the fumes given off during the self-cleaning cycle of any range. Move birds to another well-ventilated room.

### **Flat racks**

Flat racks can be left in the cavity during self-clean (if enameled racks, not shiny) or can be washed with warm, soapy water.

Racks may be more difficult to slide, especially after a self-clean. Put some vegetable oil on a soft cloth or paper towel and rub onto the left and right edges.

## **Maintenance**

### **Oven Light Replacement (on some models)**

**WARNING: SHOCK OR BURN HAZARD:** Before replacing oven light bulb, disconnect the electrical power to the oven at the main fuse or circuit breaker panel. Failure to do so may result in electric shock or burn.

**CAUTION: BURN HAZARD:** The glass cover and bulb should be removed when cool. Touching hot glass with bare hands or a damp cloth can cause burns.

1. Disconnect power at the main fuse or circuit breaker panel.
2. Remove oven racks.
3. Slide a flat blade screwdriver between the housing and the glass light cover.
4. Support the glass light cover with two fingers to prevent the cover from falling to the bottom of the oven.
5. Gently twist the screwdriver blade to loosen the glass light cover. Be careful not to chip the oven coating.
6. Remove the glass light cover.
7. Remove the bulb by firmly grasping and sliding the bulb straight out until the two prongs have cleared the ceramic holder.
8. Do not touch the glass of the new replacement bulb with your fingers. It will cause the bulb to fail when it lights. Grasp the replacement bulb with a clean towel or facial tissue with the prongs facing down. Align the two prongs in the ceramic holder, pressing gently until the bulb is securely in the ceramic socket.

9. Slide the protective lens into the holder and push until the clips snap into the housing.
10. Reconnect power.

### Oven Light Bulb (on some models)

**NOTE:** The glass cover should be removed only when cold. Wearing latex gloves may offer a better grip.

Before replacing the bulb, disconnect electrical power to the oven at the main fuse or circuit breaker panel. Let the bulb cool completely before removing it. For your safety do not touch a hot bulb with a damp cloth. If you do the bulb may break.

**To remove:**

Turn the glass cover counterclockwise 1/4 turn until the tabs of the glass cover clear the grooves of the socket. Remove the bulb.

**To replace:**

Put in a new 40-watt appliance bulb. Place the tabs of the glass cover into the grooves of the socket. Turn the glass cover clockwise 1/4 turn.

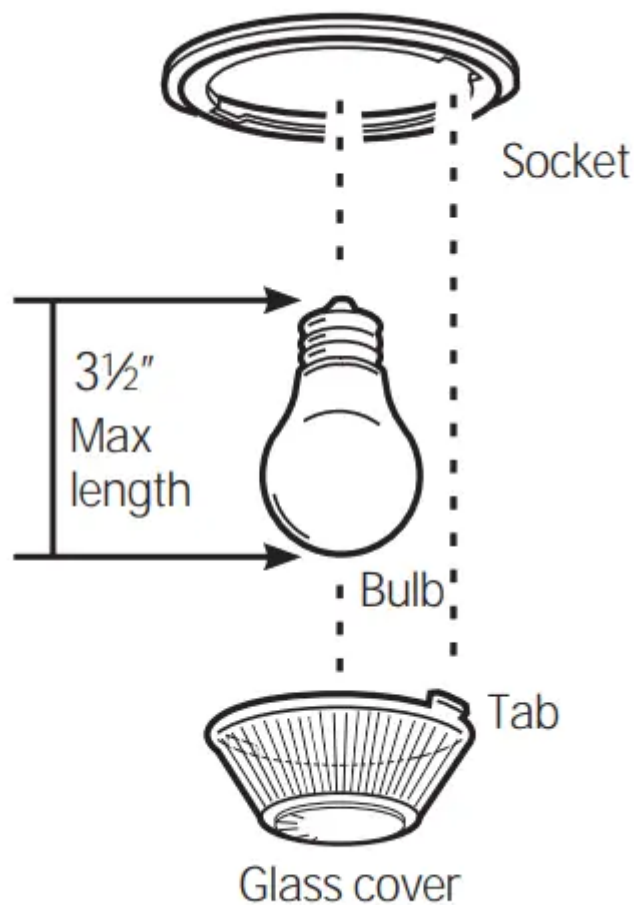

**NOTE:**

- A 40-watt appliance bulb is smaller than a standard 40-watt household bulb.
- Reconnect electrical power to the oven once the new bulb is installed.
- For improved lighting inside the oven, clean the glass cover frequently using a wet cloth. This should be done when the oven is completely cool.

**Lift-Off Oven Door**

The door is very heavy. Be careful when removing and lifting the door. Do not lift the door by the handle.

**To remove the door:**

1. Fully open the door.
2. Pull the hinge locks down toward the door frame, to the unlocked position. A tool, such as a small flat-blade screwdriver, may be required.
3. Firmly grasp both sides of the door at the top.
4. Close door to the door removal position. The door should be open approximately 3" with no obstruction above the door.
5. Lift door up and out until both hinge arms are clear of the slots.

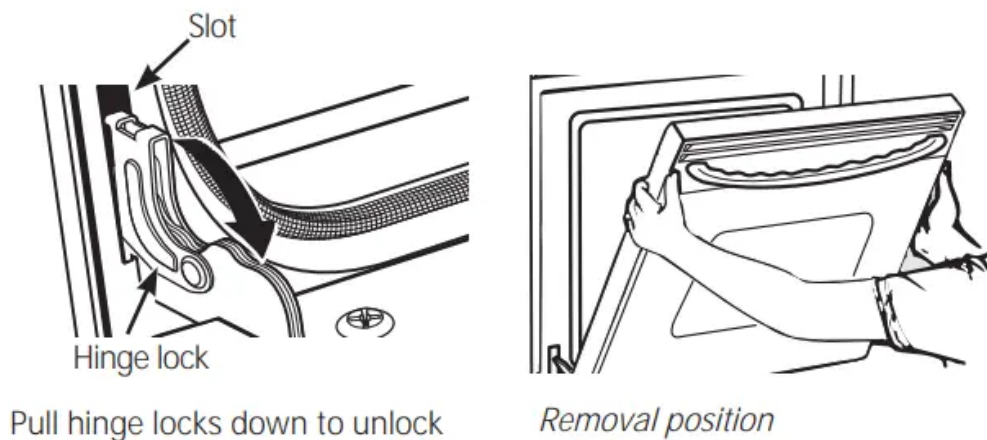

**To replace the door:**

1. Firmly grasp both sides of the door at the top.
2. Starting on the left side, with the door at the same angle as the removal position, seat the indentation of the hinge arm into the bottom edge of the hinge slot. The notch in the hinge arm must be fully seated into the bottom of the slot. Repeat for right side.
3. Fully open the door. If the door will not fully open, the indentation is not seated correctly in the bottom edge of the slot.
4. Push the hinge locks up against the front frame of the oven cavity, to the locked position.

5. Close the oven door.

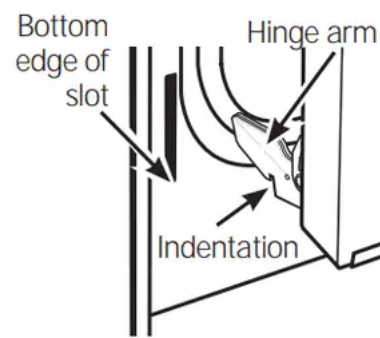
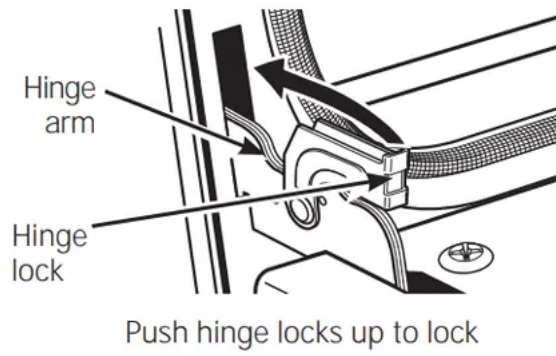

## Troubleshooting

<b>Problem</b>	<b>Possible Cause</b>	<b>What To Do</b>
<b>My new oven doesn't cook like my old one. Is something wrong with the temperature settings?</b>	Your new oven has a different cooking system from your old oven and therefore may cook differently than your old oven.	For the first few uses, follow your recipe times and temperatures carefully. If you still think your new oven is too hot or too cold, you can adjust the temperature yourself to meet your specific cooking preference.
<b>Food does not bake properly</b>	Oven controls improperly set.	See the Cooking Modes section.
	Rack position is incorrect or rack is not level.	See the Cooking Modes section and Cooking Guide.
	Incorrect cookware or cookware of improper size being used.	See the Cookware section.
	Oven temperature needs adjustment.	See the Special Features section.
	Ingredient substitution	Substituting ingredients can change the recipe outcome.
<b>Food does not broil properly</b>	Oven controls improperly set.	Make sure you select the appropriate broil mode.
	Improper rack position being used.	See Cooking Guide for rack location suggestions.
	Food being cooked in a hot pan.	Make sure cookware is cool.
	Cookware not suited for broiling.	Use a pan specifically designed for broiling.
	Aluminum foil used on the broiling pan and grid has not been fitted properly and slit as recommended.	If using aluminum foil conform to pan slits.
	In some areas the power (voltage) may be low.	Preheat the broil element for 10 minutes.



<b>Oven temperature too hot or too cold</b>	Oven temperature needs adjustment.	See the Special Features section.
<b>Oven does not work or appears not to work</b>	A fuse in your home may be blown or the circuit breaker tripped.	Replace the fuse or reset the circuit breaker.
	Oven controls improperly set.	See the Using the Oven section.
	Oven is in Sabbath Mode.	Verify, that the oven is not in Sabbath Mode. See the Special Features section.
<b>“Crackling” or “popping” sound</b>	This is the sound of the metal heating and cooling during both the cooking and cleaning functions.	This is normal.
<b>Why is my range making a “clicking” noise when using my oven?</b>	Your range has been designed to maintain a tighter control over your oven's temperature. You may hear your oven's heating elements “click” on and off more frequently than in older ovens to achieve better results during baking, broiling, and self-clean cycles.	This is normal.
<b>Clock and timer do not work</b>	A fuse in your home may be blown or the circuit breaker tripped.	Replace the fuse or reset the circuit breaker.
<b>Sometimes the oven takes longer to preheat to the same temperature</b>	Cookware or food in oven	The cookware or food in the oven will cause the oven to take longer to preheat. Remove items to reduce preheat time.
	Number of racks in oven	Adding more racks to the oven will cause the oven to take longer to preheat. Remove some racks.



<b>Oven light does not work</b>	Light bulb is loose or defective.	Tighten or replace bulb.
	Pad operating light is broken.	Call for service.
<b>Oven will not self-clean</b>	The temperature is too high to set a self-clean operation.	Allow the oven to cool and reset the controls.
	Oven controls improperly set.	See the Cleaning the Oven section.
<b>Excessive smoking during clean cycle</b>	Excessive soil or grease..	Press the Cancel/Off pad. Open the windows to rid the room of smoke. Wait until the LOCKED light goes off. Wipe up the excess soil and reset the clean cycle.
<b>Excessive smoking during broiling</b>	Food too close to burner element.	Lower the rack position of the food.
<b>Oven door will not open after a clean cycle</b>	Oven too hot.	Allow the oven to cool below locking temperature.
<b>Oven not clean after a clean cycle</b>	Oven controls improperly set.	See the Cleaning the Oven section.
	Oven was heavily soiled.	Clean up heavy spillovers before starting the clean cycle. Heavily soiled ovens may need to self-clean again or for a longer period of time.
<b>"LOCK DOOR" flashes in the display</b>	The self-clean cycle has been selected but the door is not closed.	Close the oven door.
<b>LOCKED light is on when you want to cook</b>	The oven door is locked because the temperature inside the oven has not dropped below the locking temperature.	Press the Cancel/Off pad. Allow the oven to cool.
<b>"F— and a number or letter"</b>	You have a function error code.	Press the Cancel/Off pad. Allow the oven to cool for one hour.



<b>flash in the display</b>		Put the oven back into operation.
	If the function code repeats.	Disconnect all power to the oven for at least 30 seconds and then reconnect power. If the function error code repeats, call for service.
<b>Display goes blank</b>	A fuse in your home may be blown or the circuit breaker tripped.	Replace the fuse or reset the circuit breaker.
	The clock is turned off.	See the Special features section.
	Oven is in Sabbath Mode.	Verify that the oven is not in Sabbath Mode. See the Special Features section.
<b>Power outage, clock flashes</b>	Power outage or surge	Reset the clock. If the oven was in use, you must reset it by pressing the Cancel/Off pad, setting the clock and resetting any cooking function.
<b>“Burning” or “oily” odor emitting from the vent</b>	This is normal in a new oven and will disappear in time.	To speed the process, set a self-clean cycle for a minimum of 3 hours. See the Cleaning the Oven section. This is temporary.
<b>Strong odor</b>	An odor from the insulation around the inside of the oven is normal for the first few times the oven is used.	This is temporary and will go away after several uses or a self-clean cycle.
<b>Fan noise</b>	A cooling fan may automatically turn on.	This is normal. The cooling fan will turn on to cool internal parts. It may run for up to 1-1/2 hours after the oven is turned off.
<b>My oven door glass appears to</b>	No. The inner oven glass is coated with a heat barrier to	



**be "tinted" or have a "rainbow" color. Is this defective?**

reflect the heat back into the oven to prevent heat loss and keep the outer door cool while baking.

This is normal. Under certain light or angles, you may see this tint or rainbow color.

### **Warning**

This content is compiled from multiple sources and is provided for reference purposes only. It may not be complete or fully applicable to all situations. If you are unable to resolve your issue, please contact the product manufacturer or an authorized service provider for official support.