



Dishwasher

[en] Information for Use

S189YCX01E

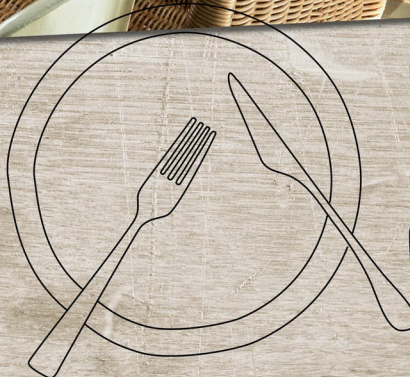





Table of contents

| | | | |
|--|-----------|--|-----------|
| Safety | 4 | Features | 23 |
| General information | 4 | Top basket | 23 |
| Intended use | 4 | Bottom basket | 24 |
| Restriction on user group | 4 | Cutlery drawer | 24 |
| Safe installation | 4 | Etagere | 25 |
| Safe use | 6 | Folding prongs | 25 |
| Damaged appliance | 8 | Basket heights | 26 |
| Risk to children | 8 | Before using for the first time | 26 |
| Safety systems | 10 | Performing initial start-up | 26 |
| Preventing material damage | 11 | Water softening system | 26 |
| Safe installation | 11 | Overview of water hardness settings | 27 |
| Safe use | 11 | Setting the water softening system | 27 |
| Childproof lock | 12 | Special salt | 27 |
| Electric childproof lock | 12 | Switching off the water softening system | 28 |
| Environmental protection and saving energy | 12 | Regeneration of the water softening system | 29 |
| Disposing of packaging | 12 | Rinse aid system | 29 |
| Saving energy | 12 | Rinse aid | 29 |
| Zeolith drying  | 12 | Setting the amount of rinse aid | 30 |
| AquaSensor | 13 | Switching the rinse aid system off | 30 |
| Sensors | 13 | Detergent | 30 |
| Open Dry | 13 | Suitable detergents | 30 |
| Installation and connection | 14 | Unsuitable detergents | 31 |
| Scope of supply | 14 | Information on detergents | 31 |
| Installing and connecting the appliance | 14 | Adding detergent | 32 |
| Drainage connection | 14 | Tableware | 33 |
| Drinking water connection | 15 | Damage to glass and tableware | 33 |
| Electrical connection | 15 | Arrange tableware | 34 |
| Familiarising yourself with your appliance | 16 | Removing tableware | 35 |
| Appliance | 16 | Basic operation | 35 |
| Controls | 17 | Opening appliance door | 35 |
| Programmes | 20 | Switching on the appliance | 35 |
| Information for test institutes | 22 | Setting a programme | 35 |
| Favourite  | 22 | Setting additional functions | 35 |
| Additional functions | 22 | | |

| | | | |
|--|-----------|--|-----------|
| Setting timer programming | 35 | Transporting the appliance | 61 |
| Starting the programme | 36 | Disposing of old appliance | 61 |
| Interrupting programme | 36 | Customer Service | 61 |
| Terminate programme..... | 36 | Product number (E-Nr.), produc- | |
| Display programme information..... | 36 | tion number (FD) and consecut- | |
| Switching off appliance | 36 | ive numbering (Z-Nr.) | 62 |
| Basic settings | 37 | AQUA-STOP guarantee | 62 |
| Overview of basic settings | 37 | Technical specifications | 62 |
| Changing basic settings..... | 39 | Information regarding Free and | |
| Setting the time | 39 | Open Source Software | 63 |
| Home Connect | 39 | Declaration of Conformity | 63 |
| Home Connect quick start | 40 | | |
| Home Connect settings..... | 40 | | |
| Remote Start  | 40 | | |
| Remote Diagnostics | 41 | | |
| Software update | 41 | | |
| Data protection..... | 41 | | |
| Cleaning and servicing | 41 | | |
| Cleaning the tub | 41 | | |
| Cleaning products | 41 | | |
| Tips on appliance care..... | 42 | | |
| Easy Clean ^{Easy} _{Clean} | 42 | | |
| Filter system | 43 | | |
| Cleaning spray arms | 44 | | |
| Troubleshooting | 45 | | |
| Appliance safety | 45 | | |
| Error code / Fault display / Sig- | | | |
| nal..... | 47 | | |
| Washing results | 49 | | |
| Home Connect problem..... | 56 | | |
| Information on display panel..... | 56 | | |
| Malfunctions | 56 | | |
| Mechanical damage..... | 58 | | |
| Noise | 58 | | |
| Clean wastewater pump..... | 60 | | |
| Transportation, storage and | | | |
| disposal | 60 | | |
| Removing the appliance | 60 | | |
| Protect appliance from frost..... | 61 | | |



Safety

Observe the following safety instructions.

General information

- Read this instruction manual carefully.
- Keep the instruction manual and the product information safe for future reference or for the next owner.
- Do not connect the appliance if it has been damaged in transit.

Intended use

Only use this appliance:

- For cleaning household tableware.
- In private households and in enclosed spaces in a domestic environment.
- Up to an altitude of 2500 m above sea level.

Restriction on user group

This appliance may be used by children aged 8 or over and by people who have reduced physical, sensory or mental abilities or inadequate experience and/or knowledge, provided that they are supervised or have been instructed on how to use the appliance safely and have understood the resulting dangers.

Do not let children play with the appliance.

Cleaning and user maintenance must not be performed by children unless they are being supervised.

Keep children under the age of 8 years away from the appliance and power cable.

Safe installation

WARNING – Risk of injury!

Improper installation may cause injury.

- ▶ When installing and connecting the appliance, follow the instructions in the manual and installation instructions.

⚠ WARNING – Risk of electric shock!

- Incorrect installation is dangerous.
 - ▶ Connect and operate the appliance only in accordance with the specifications on the rating plate.
 - ▶ Always use the supplied power cable for the new appliance.
 - ▶ Connect the appliance to a power supply with alternating current only via a properly installed socket with earthing.
 - ▶ The protective conductor system of the domestic electrical installation must be properly installed.
 - ▶ Never equip the appliance with an external switching device, e.g. a timer or remote control.
 - ▶ When the appliance is installed, the mains plug of the power cord must be freely accessible. If free access is not possible, an all-pole isolating switch must be installed in the permanent electrical installation according to the installation regulations.
 - ▶ When installing the appliance, check that the power cable is not trapped or damaged.
- Cutting through the supply hose or immersing the Aqua-Stop valve in water is dangerous.
 - ▶ Never immerse the plastic housing in water. The plastic housing on the supply hose contains an electric valve.
 - ▶ Never cut through the supply hose. The supply hose contains electric power cables.

⚠ WARNING – Risk of fire!

- It is dangerous to use an extended power cord and non-approved adapters.
 - ▶ Do not use extension cables or multiple socket strips.
 - ▶ Only use adapters and power cords approved by the manufacturer.
 - ▶ If the power cord is too short and a longer one is not available, please contact an electrician to have the domestic installation adapted.

- Contact between the appliance and installation lines may lead to a defect in these lines, e.g. gas pipes and power lines. Gas from a corroded gas pipe can ignite. A damaged power line can cause a short circuit.
 - ▶ Check that there is a distance of at least 5 cm between the appliance and installation lines.

⚠ WARNING – Risk of injury!

Hinges move when opening and closing the appliance door and can cause injury.

- ▶ If built-under or integrable appliances are not in a cavity so that one side is accessible, the hinge area must be covered at the side. Covers are available from Customer Service or specialist outlets.

⚠ WARNING – Risk of tipping!

Improper installation may cause the appliance to tip up.

- ▶ Only install built-under or integrable appliances under a continuous worktop that is securely connected to adjacent cabinets.

Safe use

⚠ WARNING – Risk of serious harm to health!

Failure to comply with safety instructions and directions for use on packagings of detergent and rinse aid products may cause serious harm to health.

- ▶ Follow the safety instructions and directions for use on the packagings of detergent and rinse aid products.

⚠ WARNING – Risk of explosion!

- Adding solvents to the interior of the appliance may cause explosions.
 - ▶ Never add solvents to the interior of the appliance.

- Highly caustic alkaline or highly acidic cleaning agents in conjunction with aluminium parts in the interior of the appliance may cause explosions.
 - ▶ Never use highly caustic alkaline or highly acidic cleaning agents, in particular commercial or industrial products, in conjunction with aluminium parts (e.g. grease filters of extractor hoods or aluminium pans), e.g. for the Machine Care programme.

⚠ WARNING – Risk of injury!

- Leaving the appliance door open may result in injury.
 - ▶ Only open the appliance door to load or unload tableware in order to prevent accidents, e.g. through tripping.
 - ▶ Do not sit or stand on the appliance door when open.
- Knives and utensils with sharp points can cause injuries.
 - ▶ Arrange knives and utensils with sharp points in the cutlery basket with the points downwards, on the knife shelf or in the cutlery drawer.

⚠ WARNING – Risk of scalding!

If you open the appliance door while the programme is running, hot water may splash out of the appliance.

- ▶ Open the appliance door carefully if the programme is still running.

⚠ WARNING – Risk of electric shock!

- An ingress of moisture can cause an electric shock.
 - ▶ Only use the appliance in enclosed spaces.
 - ▶ Never expose the appliance to intense heat or humidity.
 - ▶ Do not use steam- or high-pressure cleaners to clean the appliance.
- If the insulation of the power cord is damaged, this is dangerous.
 - ▶ Never let the power cord come into contact with hot appliance parts or heat sources.
 - ▶ Never let the power cord come into contact with sharp points or edges.

- ▶ Never kink, crush or modify the power cord.

⚠ WARNING – Risk of burns!

The blow opening of the Zeolith container becomes hot and can cause burns.

- ▶ Never touch the blow opening of the Zeolith container.

Damaged appliance

⚠ WARNING – Risk of electric shock!

- If the appliance or the power cord is damaged, this is dangerous.
 - ▶ Never operate a damaged appliance.
 - ▶ Never operate an appliance with a cracked or fractured surface.
 - ▶ Never pull on the power cord to unplug the appliance. Always unplug the appliance at the mains.
 - ▶ If the appliance or the power cord is damaged, immediately unplug the power cord or switch off the fuse in the fuse box and turn off the water tap.
 - ▶ "Call customer services." → *Page 61*
- Incorrect repairs are dangerous.
 - ▶ Repairs to the appliance should only be carried out by trained specialist staff.
 - ▶ Only use genuine spare parts when repairing the appliance.
 - ▶ If the power cord of this appliance is damaged, it must be replaced with a special connection cable, which is available from the manufacturer or his Customer Service.

Risk to children

⚠ WARNING – Risk of suffocation!

- Children may put packaging material over their heads or wrap themselves up in it and suffocate.
 - ▶ Keep packaging material away from children.
 - ▶ Do not let children play with packaging material.

- Children may breathe in or swallow small parts, causing them to suffocate.
 - ▶ Keep small parts away from children.
 - ▶ Do not let children play with small parts.
- Children may become trapped in the appliance and suffocate.
 - ▶ Use the childproof lock if fitted.
 - ▶ Never let children play with or operate the appliance.

⚠ WARNING – Risk of harm to health!

Children can lock themselves in the appliance, thereby putting their lives at risk.

- ▶ With redundant appliances, unplug the power cord. Then cut through the cord and damage the lock on the appliance door beyond repair so that the appliance door will no longer close.

⚠ WARNING – Risk of crushing!

With higher-level appliances, children can become crushed between the appliance door and cabinet doors underneath.

- ▶ Keep an eye on children when opening and closing the appliance door.

⚠ WARNING – Risk of chemical burns!

Rinse aid and detergent may cause chemical burns to the mouth, throat and eyes.

- ▶ Keep children away from detergent and rinse aid products.
- ▶ Keep children away from the appliance when open. The water in the interior of the dishwasher is not drinking water. It may contain residues of detergents and rinse aid.

⚠ WARNING – Risk of injury!

Children may get their fingers caught in the slots of the tablet collecting tray and injure themselves.

- ▶ Keep children away from the appliance when open.

Safety systems

Protect children from possible hazards resulting from the appliance.

The appliance is equipped with a "Childproof lock " → *Page 12.*

Preventing material damage

Safe installation

ATTENTION!

- Improper installation of the appliance may cause damage.
 - ▶ If the dishwasher is installed above or below other domestic appliances, follow the information on installation in combination with a dishwasher in the installation instructions for the individual appliances.
 - ▶ If there is no information or if the installation instructions do not include the relevant information, contact the manufacturer of these appliances to check that the dishwasher can be installed above or below these appliances.
 - ▶ If no information is available from the manufacturer, the dishwasher should not be installed above or below such appliances.
 - ▶ To ensure the safe operation of all domestic appliances, continue following the installation instructions for the dishwasher.
 - ▶ Do not install the dishwasher under a hob.
 - ▶ Do not install the dishwasher near heat sources, e.g. radiators, heat storage tanks, ovens or other appliances that generate heat.
- Contact between the appliance and water pipes may lead to corrosion of these pipes, possibly causing them to leak.
 - ▶ Check that there is a distance of at least 5 cm between the appliance and the water pipe. The

pipes supplied for the drinking water and waste water connections are not affected here.

- Modified or damaged water hoses may result in material damage and damage to the appliance.
 - ▶ Never kink, crush, modify or cut through water hoses.
 - ▶ Only use the water hoses supplied with the appliance or genuine spare hoses.
 - ▶ Never re-use water hoses that have been used before.
- If the water pressure is too high or too low, the appliance may not be able to operate properly.
 - ▶ Make sure that the water pressure in the water supply system is min. 50 kPa (0.5 bar) and max. 1000 kPa (10 bar).
 - ▶ If the water pressure exceeds the maximum value specified, a pressure-reducing valve must be installed between the drinking water connection and the hose set of the appliance.

Safe use

ATTENTION!

- Escaping water vapour can damage fitted units.
 - ▶ When the programme ends, leave the appliance to cool down for a while before opening the door.
- Special salt for dishwashers can damage the tub due to corrosion.
 - ▶ To make sure that any special salt that escapes is washed out of the tub, add the special salt to the dispenser for special salt immediately before the programme starts.
- Detergent may damage the water softening system.
 - ▶ Only fill the dispenser of the water softening system with special dishwasher salt.

- Unsuitable cleaning agents may damage the appliance.
 - ▶ Do not use a steam cleaner.
 - ▶ So as not to scratch the finish on the appliance, do not use sponges with a rough surface or abrasive cleaning agents.
 - ▶ To prevent corrosion, do not use sponge cloths on dishwashers with a stainless steel front or rinse such cloths thoroughly several times before using them for the first time.

Childproof lock

The childproof lock lets you protect children from possible hazards resulting from the appliance.

The appliance is equipped with an electrical childproof lock.

If you have activated the childproof lock, this means that "automatic door opening" → *Page 13* is deactivated.

Electric childproof lock

The electric childproof lock makes it more difficult to open the appliance door.

You can activate or deactivate the electric childproof lock in the "Basic settings" → *Page 37*.

WARNING

Risk of suffocation!

Children may become trapped in the appliance and thus suffocate.

- ▶ Activate the electric childproof lock and close the appliance door.

→ *"Opening appliance door", Page 35*

Environmental protection and saving energy

Disposing of packaging

The packaging materials are environmentally compatible and can be recycled.

- ▶ Sort the individual components by type and dispose of them separately.

Saving energy

If you follow these instructions, your appliance will use less electricity and less water.

Use the Eco 50 ° programme.

- + The Eco 50 ° programme is energy-efficient and environmentally friendly.
→ *"Programmes", Page 20*

Change the sensor setting to the default.

- + Consumption is reduced.
→ *"Sensors", Page 13*

Zeolith drying automatically helps to save energy.

- + → *"Zeolith drying ", Page 12*

Zeolith drying

The appliance features a Zeolith container. Zeolith drying lets you save energy.

Zeolite is a mineral that can store moisture and heat energy and then release them again.

During dishwashing heat energy is used to heat up the washing water and dry the mineral.

During the drying phase moisture from the interior of the dishwasher is stored in the mineral and heat energy is released. The heat energy is blown out into the interior of the dishwasher with dry air. This speeds up and improves drying.

Zeolith drying therefore saves a great deal of energy.

Tip: To avoid impairing Zeolith drying performance, do not position tableware parts directly in front of the intake opening or the blow opening of the Zeolith container.

Do not position heat-sensitive tableware parts directly in front of the blow opening of the Zeolith container.

→ *"Appliance", Page 16*

AquaSensor

The AquaSensor is an optical measuring device (light barrier) which measures the turbidity of the rinsing water. You can save water with the AquaSensor.

Use of the AquaSensor depends on the programme. If the soiling level is high, the rinsing water is drained off and replaced with fresh water. If the soiling level is lower, the rinsing water is used in the next wash cycle, so reducing water consumption by 3-6 litres. In the automatic programmes the temperature and run time are additionally adjusted to the level of soiling.

Sensors

The sensors adjust the programme sequence and strength in the automatic programmes depending on the level and type of soiling.

The sensor has different sensitivity settings that can be changed in the basic settings.

→ *"Changing basic settings", Page 39*

| Sensor setting | Description |
|----------------|--|
| Standard | Optimum setting for a mixed load and heavily soiled tableware. Saves both energy and water. |
| Sensitive | Adjusts the programme strength for effective removal of food remnants even with low soiling levels. Energy and water consumption are adjusted accordingly. |
| Very sensitive | Adjusts the programme strength for difficult conditions of use, e.g. stubborn dried-on food remnants. Recommended setting when using organic or ecological detergents containing low levels of active agents. Energy and water consumption are adjusted accordingly. |

Open Dry

The appliance door opens automatically during the drying phase. This ensures a particularly economical drying result.

For best drying results wait until the end of programme before unloading the tableware. The programme has ended when the display shows "Finished".

If automatic door opening is deactivated, energy consumption increases and the drying phase is usually shortened.

→ *"Overview of basic settings", Page 37*

Installation and connection

To ensure proper operation, connect the appliance to the power and water supply correctly. Observe the specified criteria and the installation instructions.

Scope of supply

After unpacking all parts, check for any damage in transit and completeness of the delivery.

If you have any complaints, contact the dealer who sold you the appliance or our Customer Service.

Note: The appliance has been tested at the factory to check it is in working order. It is possible that water has left marks on the appliance. These marks will disappear after the first wash cycle.

The delivery consists of the following:

- Dishwasher
- Operating instructions
- Installation Instructions
- Further information documents
- Installation material
- Steam guard plate
- Salt filling aid funnel
- Mains cable
- Quick reference guide

Installing and connecting the appliance

You can position your built-under or integrable appliance in a fitted kitchen between wooden and plastic walls. If you subsequently install your dishwasher as a free-standing appliance, you must stop it from tipping over, e.g. by screwing it to the wall or

installing it under a continuous worktop that is securely connected to adjacent cabinets.

1. "Follow the safety instructions." → *Page 4*
2. "Follow the instructions for electrical connection." → *Page 15*
3. Check the Scope of supply and the condition of the appliance.
4. Consult the installation instructions for the installation dimensions required.
5. Make the appliance level using the height-adjustable feet.
Make sure that the appliance is standing on the floor securely.
6. "Install the drainage connection." → *Page 14*
7. "Install the drinking water connection." → *Page 15*
8. Connect the appliance to the power supply.

Drainage connection

Connect your appliance to drainage connection so dirty water is discharged via the wash cycle.

Installing the drainage connection

1. Consult the installation instructions supplied for the steps required here.
2. Connect the wastewater hose to the outlet connection of the siphon using the enclosed parts.
3. When doing so, check that the wastewater hose is not kinked, crushed or twisted.
4. Also check that there is no cover in the drainage system preventing the wastewater from being discharged.

Drinking water connection

Connect your appliance to a drinking water connection.

Installing the drinking water connection

Note

- If you are replacing the appliance, you must use a new water supply hose.
1. Consult the installation instructions supplied for the steps required here.
 2. Connect the appliance to the drinking water connection using the enclosed parts.
Observe the "Technical data"
→ *Page 62*.
 3. When doing so, check that the drinking water connection is not kinked, crushed or twisted.

Electrical connection

Connecting the appliance to the electricity supply

Notes

- Please follow the "Safety instructions" → *Page 4*.
 - Connect the appliance to alternating current only, in the range of 220 - 240 V and 50 Hz or 60 Hz.
 - Please note that the water safety system is only functional if there is a power supply.
1. Insert the non-heating appliance plug of the power cable into the appliance.
 2. Insert the mains plug of the appliance into a nearby socket.
The connection data for the appliance can be found on the rating plate.
 3. Check that the mains plug is inserted properly.

Familiarising yourself with your appliance

Appliance

You can find an overview of the parts of your appliance here.

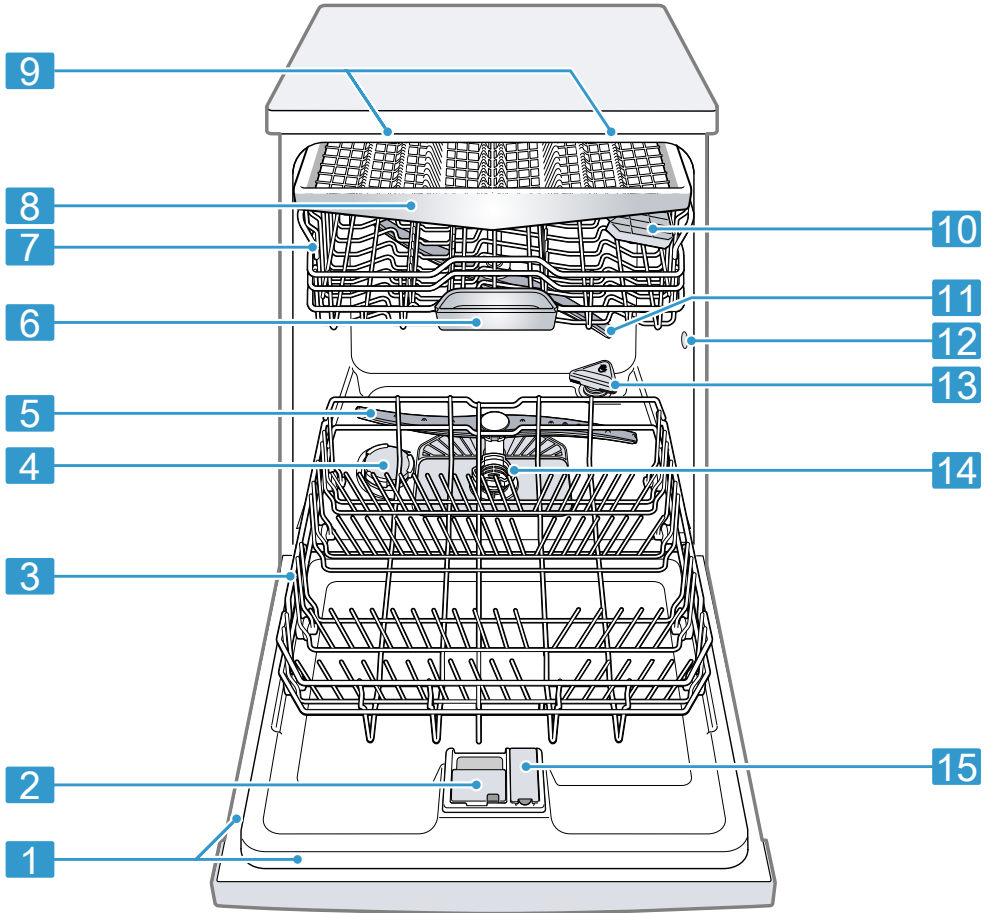

- | | | |
|----------|--------------|--|
| 1 | Rating plate | Rating plate with "E number and FD number" → Page 62. The data you need for "Customer Service" → Page 61. |
|----------|--------------|--|

¹ Depending on the appliance specifications

| | | |
|-----------|---|--|
| 2 | Detergent dispenser | "Detergent" → <i>Page 30</i> is added to the detergent dispenser. |
| 3 | Bottom basket | "Bottom basket" → <i>Page 24</i> |
| 4 | Dispenser for special salt | Add special salt to the dispenser for special salt. → " <i>Water softening system</i> ", <i>Page 26</i> |
| 5 | Lower spray arm | The lower spray arm washes the tableware in the bottom basket. If the tableware has not been washed properly, clean the spray arms. → " <i>Cleaning spray arms</i> ", <i>Page 44</i> |
| 6 | Tablet collecting tray | During the wash cycle tablets automatically fall out of the detergent dispenser into the tablet collecting tray where they can fully dissolve. |
| 7 | Top basket | "Top basket" → <i>Page 23</i> |
| 8 | Cutlery drawer | "Cutlery drawer" → <i>Page 24</i> |
| 9 | EmotionLight | Interior lighting of the appliance. → " <i>Overview of basic settings</i> ", <i>Page 37</i> |
| 10 | Cutlery shelf ¹ | "Cutlery shelf" → <i>Page 25</i> |
| 11 | Upper spray arm | The upper spray arm washes the tableware in the top basket. If the tableware has not been washed properly, clean the spray arms. → " <i>Cleaning spray arms</i> ", <i>Page 44</i> |
| 12 | Intake opening of the Zeolith container | The intake opening is required for "Zeolith drying" → <i>Page 12</i> . |
| 13 | Blow opening of the Zeolith container | The blow opening is required for "Zeolith drying" → <i>Page 12</i> . |
| 14 | Filter system | "Filter system" → <i>Page 43</i> |
| 15 | Dispenser for rinse aid | Add rinse aid to the dispenser for rinse aid. → " <i>Rinse aid system</i> ", <i>Page 29</i> |





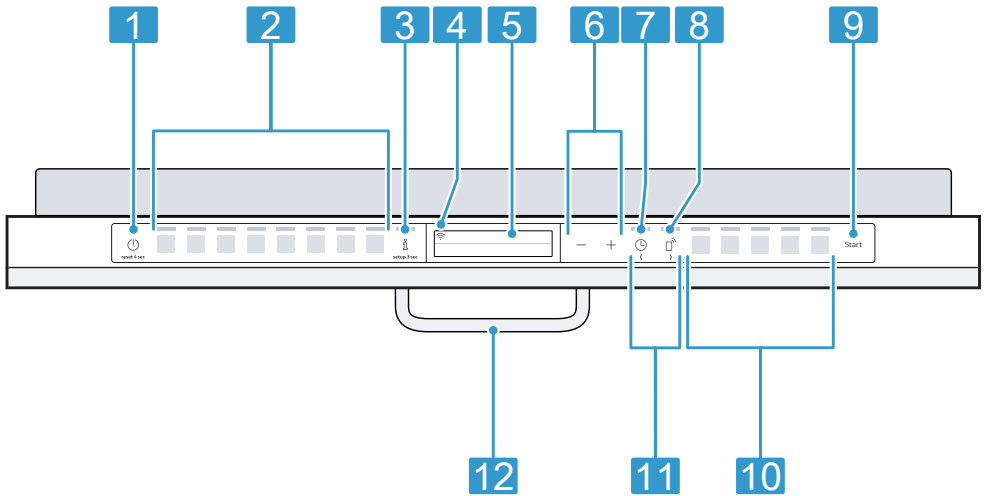

¹ Depending on the appliance specifications

Controls

You can use the control panel to configure all functions of your appliance and to obtain information about the operating status.
With some buttons you can perform different functions.

en Familiarising yourself with your appliance



| | | |
|-----------|--|--|
| 1 | ON/OFF button  and reset button Reset 4 sec. | "Switching on the appliance" → Page 35 "Switching off the appliance" → Page 36 "Terminating the programme" → Page 36 |
| 2 | Programme buttons | "Programmes" → Page 20 |
| 3 | Info button  | If you press  , the display shows information about selected programmes, basic settings and additional functions. If you press  for approx. 3 seconds, you can open the menu. → "Changing basic settings", Page 39 |
| 4 | WLAN display | "Home Connect" → Page 39 |
| 5 | Display ¹ | The display shows information about programmes, basic settings or additional functions. You can change the basic settings via the display and the setting buttons. → "Changing basic settings", Page 39 |
| 6 | Setting buttons | "Changing the basic settings" → Page 39 |
| 7 | Timer programming | "Setting timer programming" → Page 35 |
| 8 | Remote Start  | → "Remote Start  ", Page 40 |
| 9 | Start button Start | "Starting the programme" → Page 36 |
| 10 | Programme buttons and additional functions | Programmes → "Programmes", Page 20 Additional functions → "Additional functions", Page 22 |

¹ Depending on the appliance specifications

| | | |
|-----------|--------------------------|--|
| 11 | <> buttons | You can use these buttons to scroll between the basic settings. → <i>"Changing basic settings", Page 39</i> |
| 12 | Door handle ¹ | "Open the appliance door." → <i>Page 35</i> |

¹ Depending on the appliance specifications

Programmes

You can find an overview of the programmes that can be selected here. Different programmes, which can be found on the control panel of your appliance, are available depending on the appliance configuration.

The running time may vary depending on the programme selected. The running time depends on the water temperature, the quantity of tableware, the level of soiling and the additional function selected. The

runtime will change if the rinse aid system is switched off or rinse aid needs to be added.

The consumption values can be found in the quick reference guide. The consumption values relate to normal conditions and a water hardness of 16 - 20 °E. Different influencing factors such as water temperature or pipe pressure may result in deviations.

| Programme: | Use | Programme sequence | Additional functions |
|----------------------------|--|--|---|
| Chef Chef 70 | Tableware: <ul style="list-style-type: none"> Washing pots and pans, non-fragile tableware and cutlery. Level of soiling: <ul style="list-style-type: none"> Removing stubborn burned or dried-on food remnants containing starch and protein. | Intensive: <ul style="list-style-type: none"> Pre-Rinse Cleaning 70 °C Intermediate rinse Final rinse 65 °C Extra Dry | Extra Hygiene Extra Shine Extra Speed → "Additional functions", Page 22 |
| Auto Auto 45-65° | Tableware: <ul style="list-style-type: none"> Cleaning mixed tableware and cutlery. Level of soiling: <ul style="list-style-type: none"> Removing common household food remnants lightly dried-on. | Sensor-controlled: <ul style="list-style-type: none"> Optimised by sensors depending on the soiling of the rinsing water. | All → "Additional functions", Page 22 |
| Eco Eco 50° | Tableware: <ul style="list-style-type: none"> Cleaning mixed tableware and cutlery. Level of soiling: <ul style="list-style-type: none"> Removing common household food remnants lightly dried-on. | Most economical programme: <ul style="list-style-type: none"> Pre-Rinse Cleaning 50 °C Intermediate rinse Final rinse 35 °C Drying | All → "Additional functions", Page 22 |

| Programme: | Use | Programme sequence | Additional functions |
|--|--|---|---|
| Silence Silence 50° | <p>Tableware:</p> <ul style="list-style-type: none"> ■ Cleaning mixed tableware and cutlery. <p>Level of soiling:</p> <ul style="list-style-type: none"> ■ Removing common household food remnants lightly dried-on. | <p>Reduced noise:</p> <ul style="list-style-type: none"> ■ Pre-Rinse ■ Cleaning 50 °C ■ Intermediate rinse ■ Final rinse 35 °C ■ Dry | <p>All → "Additional functions", Page 22</p> |
| Glass Glass 40° | <p>Tableware:</p> <ul style="list-style-type: none"> ■ Cleaning delicate tableware, cutlery, temperature-sensitive plastics, glasses and stemware in the stemware basket. <p>Level of soiling:</p> <ul style="list-style-type: none"> ■ Removing lightly adhering fresh food remnants. | <p>Particularly gentle:</p> <ul style="list-style-type: none"> ■ Pre-Rinse ■ Cleaning 40 °C ■ Intermediate rinse ■ Final rinse 50 °C ■ Dry | <p>Power Zone Extra Shine Extra Speed → "Additional functions", Page 22</p> |
| Classic Classic 60° | <p>Tableware:</p> <ul style="list-style-type: none"> ■ Cleaning mixed tableware and cutlery. <p>Level of soiling:</p> <ul style="list-style-type: none"> ■ Removing common household food remnants lightly dried-on. | <p>Time-optimised:</p> <ul style="list-style-type: none"> ■ Cleaning 60 °C ■ Intermediate rinse ■ Final rinse 50 °C ■ Dry | <p>All → "Additional functions", Page 22</p> |
| Express Express 45° | <p>Tableware:</p> <ul style="list-style-type: none"> ■ Cleaning delicate tableware, cutlery, temperature-sensitive plastics and glasses. <p>Level of soiling:</p> <ul style="list-style-type: none"> ■ Removing lightly adhering fresh food remnants. | <p>Time-optimised:</p> <ul style="list-style-type: none"> ■ Cleaning 45 °C ■ Intermediate rinse ■ Final rinse 50 °C | <p>Extra Shine → "Additional functions", Page 22</p> |
| Easy Clean Easy Clean | Use only if appliance is unloaded. | Machine Care 70 °C | None |
|  | - | - | - |
| Favourite | | | |

Note: The relatively long running time in the Eco 50 ° programme is due to longer soaking and drying times. This results in optimal consumption values.

Information for test institutes

Test institutes are provided with information for comparability tests, e.g. according to EN60436.

These are the conditions for conducting the tests, however they are not the results or consumption values. E-mail enquiries to: dishwasher@test-appliances.com

The product number (E-Nr.) and the production number (FD) are required here. They can be found on the rating plate on the appliance door.

Favourite



You can save a combination of a programme and an additional function to the  button.

You can save the program via the Home Connect app or on the appliance.

The pre-rinse program is saved to this button at the factory. Pre-rinse is suitable for all types of tableware. The tableware undergoes intermediate cleaning via cold rinsing.

Tip: You can use the Home Connect app to download additional programmes and save them to the  button.¹

Save Favourite on the appliance.

1. Open the appliance door.
 2. Press .
 3. Press the right programme button.
→ "Programmes", Page 20
 4. Press the button for the relevant additional function.
→ "Additional functions", Page 22
 5. Press  for 3 seconds.
- ✓ The selected programme and the additional function will flash.

- ✓  flashes.
- ✓ The programme and the additional function are saved.

Tip: To reset the programme, either use the Home Connect app or reset your appliance back to the factory settings.
→ "Overview of basic settings", Page 37

Additional functions

You can find an overview of the additional functions that can be selected here. Different additional functions, which can be found on the control panel of your appliance, are available depending on the appliance configuration.

| Additional function | Use |
|---------------------|-----|
|---------------------|-----|

Extra Speed

Extra Speed

- The run time is shortened by 15% to 75% depending on the rinse programme.
- The additional function can be activated before the start of the programme and at any time when the programme is running.
- Energy and water consumption are increased.

If you select this additional function, "automatic door opening" → Page 37 in the "On with Eco 50°" setting is deactivated.

¹ Depending on the appliance specifications

Additional function

Extra Hygiene

Extra Hygiene

- To ensure a higher hygiene status for the appliance and tableware, the temperature is raised and maintained for an extra-long period.
- Especially suitable for cleaning chopping boards or baby bottles.
- Continuous use of this function increases the hygiene status.
- This will increase the run time and energy consumption.

Power Zone

Power Zone

- Switch on with mixed loads containing tableware with different soiling levels, e.g. place very soiled pots and pans in the bottom basket and normally soiled tableware in the upper basket.
- The spray pressure in the bottom basket is increased and the maximum programme temperature held longer. This will increase the run time and energy consumption.

Extra Shine

Extra Shine

- To avoid marks and improve drying, the quantity of water is increased and the drying phase extended.
 - Energy consumption increases.
 - Use rinse aid.
-

Features

You can find an overview of the possible features of your appliance and how to use them here. These features depend on the model of your appliance.

Top basket

Arrange cups, glasses and small items of tableware in the top basket.

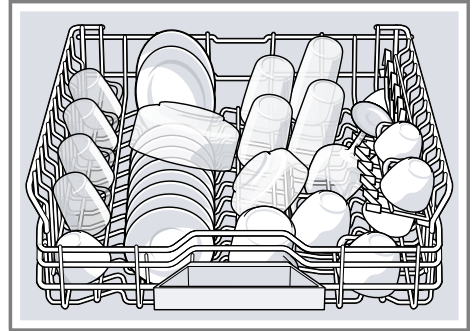

You can adjust the height of the top basket to make room for larger items of tableware.

Adjusting top basket with side levers

To wash large items of tableware in the baskets, adjust the shelf position of the top basket.

1. Pull out the top basket.
2. To prevent the basket from suddenly dropping down, hold the side of the basket by the top edge.

en Features

3. Press in the levers on the right and left on the outside of the basket.

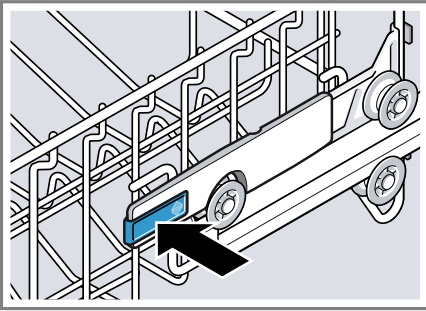

4. Raise or lower the basket evenly to the right level.

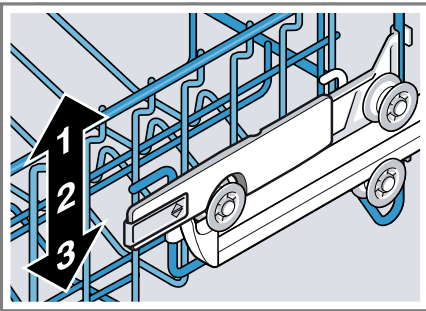

Check that the basket is level on both sides.

5. Release the levers.
- ✓ The basket clicks into position.
6. Slide the basket back in.

Bottom basket

Arrange pans and plates in the bottom basket.

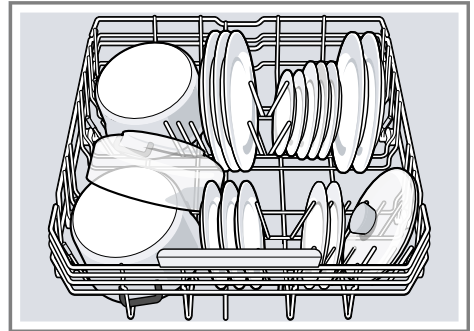

Large plates up to a diameter of 31 cm can be arranged in the bottom basket as shown.

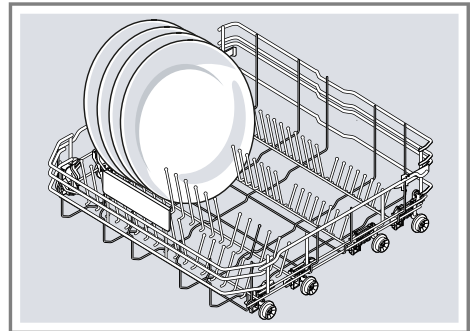

Cutlery drawer

Arrange cutlery in the cutlery drawer.

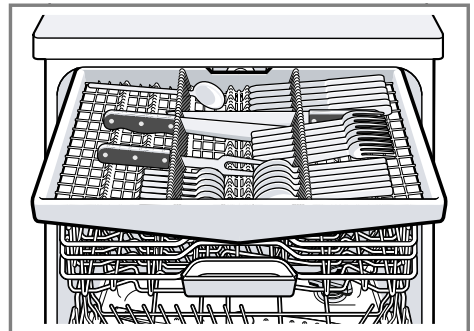

Arrange cutlery with the points and sharp edges downwards.

Etagere

Use the cutlery shelf and space underneath for small cups and glasses or for large items of cutlery, e.g. cooking spoons or serving cutlery.

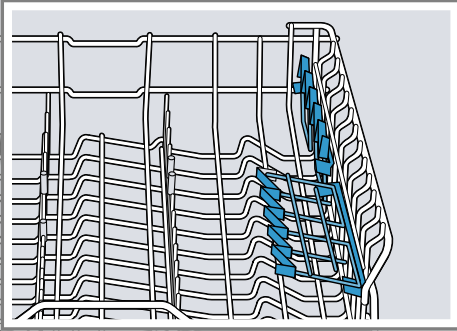

If you do not need the cutlery shelf, you can fold it up.

Folding prongs

Use the folding prongs to position tableware securely, e.g. plates.

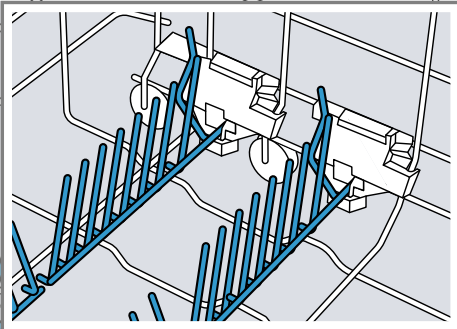

You can fold the prongs down to position pans, bowls and glasses better.¹

Folding down prongs¹

If you do not need the prongs, fold them down.

1. Push the lever forwards ① and fold down the prongs ②.

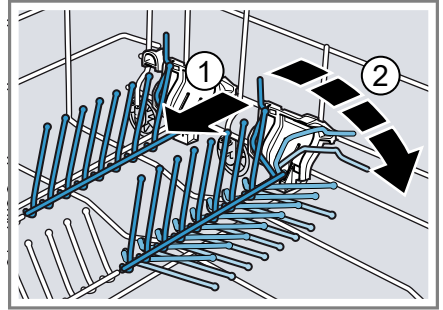

2. To use the prongs again, fold them back up.
 - ✓ The prongs audibly click into position.

¹ Depending on the appliance specifications

en Before using for the first time

Basket heights

Set the baskets at the right height.

Appliance height 81.5 cm with cutlery drawer

| Level | Top basket | Bottom basket |
|----------|------------|--------------------------------|
| 1 max. ø | 16 cm | 30 cm/"31 cm" → <i>Page 24</i> |
| 2 max. ø | 18.5 cm | 27.5 cm |
| 3 max. ø | 21 cm | 25 cm |

Before using for the first time

Performing initial start-up

On initial start-up or after a reset to the factory settings, you will need to make settings. The display shows the settings for initial start-up.

Tip: Connect your appliance to a mobile device. You can conveniently change all settings via the Home Connect app.

→ *"Home Connect quick start", Page 40*

Requirement: "The appliance has been installed and connected."

→ *Page 14*

1. "Add special salt." → *Page 27*
2. "Add rinse aid." → *Page 29*
3. Switch on the appliance.
✓ The display shows the settings for initial start-up.
4. Press > repeatedly until the display shows the required setting.

Note: If you select Initial start-up Home Connect here, make further settings using the Home Connect app on your mobile device.

You can change the settings for initial start-up and other "Basic settings" → *Page 37* on the appli-

ance at any time or use the Home Connect app on your mobile device.

5. Press — or + repeatedly until the display shows the right value.
You can change several settings.
6. To save the settings, press  for approx. 3 seconds.
7. "Add detergent" → *Page 30*.
8. Start the Programme with the highest cleaning temperature without tableware.

To remove any marks from water or other residues, we recommend you operate the appliance without tableware before using it for the first time.

Water softening system

Hard water leaves limescale on the tableware as well as the washing tank and parts of the appliance may become blocked.

To ensure good dishwashing results, you can treat the water with special salt and the water softening system. To avoid damage to the appliance, water with a hardness above 9 °E must be softened.

Overview of water hardness settings

You can find an overview of the water hardness values that can be selected here.

You can find out how hard your water is from your local water company or by using a water hardness tester.

| Water hardness °E | Hardness range | mmol/l | Setting value |
|-------------------|----------------|-----------|---------------|
| 0 - 8 | Soft | 0 - 1.1 | 0 - 8 |
| 9 - 10 | Soft | 1.2 - 1.4 | 9 - 10 |
| 11 - 12 | Medium | 1.5 - 1.8 | 11 - 12 |
| 13 - 15 | Medium | 1.9 - 2.1 | 13 - 15 |
| 16 - 20 | Medium | 2.2 - 2.9 | 16 - 20 |
| 21 - 26 | Hard | 3.0 - 3.7 | 21 - 26 |
| 27 - 38 | Hard | 3.8 - 5.4 | 27 - 38 |
| 39 - 62 | Hard | 5.5 - 8.9 | 39 - 62 |

Note: Set the water hardness determined on your appliance.

→ "Setting the water softening system", Page 27

With a water hardness of 0 - 8 °E you can dispense with special salt for dishwashers and switch off the water softening system.

→ "Switching off the water softening system", Page 28

Setting the water softening system

Set the water hardness on your appliance.

1. Determine the water hardness and the appropriate setting value.
→ "Overview of water hardness settings", Page 27
2. Press \odot .
3. To open the basic settings, press  for approx. 3 seconds.
4. Press \triangleright repeatedly until the display shows "Water hardness".
5. Press $-$ or $+$ repeatedly until the right water hardness has been set.

The value 16 - 20 is set at the factory.

6. To save the settings, press  for approx. 3 seconds.

Special salt

You can use special salt to soften water.

Adding special salt

If the special salt refill indicator lights up, add special salt to the dispenser for special salt just before the programme starts. The consumption of special salt depends on the water hardness. The higher the water hardness, the greater the consumption of special salt.

ATTENTION!

- Detergent may damage the water softening system.
 - ▶ Only fill the dispenser of the water softening system with special dishwasher salt.

en Water softening system

- Special salt for dishwashers can damage the tub due to corrosion.
 - ▶ To make sure that any special salt that escapes is washed out of the tub, add the special salt to the dispenser for special salt immediately before the programme starts.
- 1. Unscrew the lid of the dispenser for special salt and remove.
- 2. On initial start-up: Fill the dispenser right up with water.
- 3. **Note:** Only use special salt for dishwashers.
Do not use salt tablets.
Do not use table salt.
Add the special salt to the dispenser.

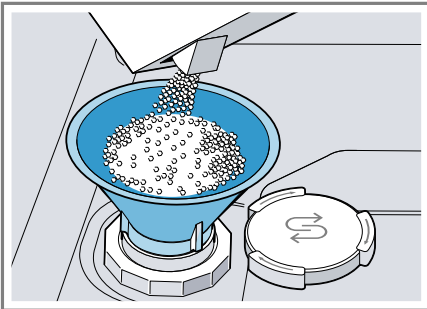







- Fill the dispenser right up with special salt. The water in the dispenser is displaced and forced out.
4. Place the lid back on the dispenser and turn to close.

Switching off the water softening system

If you find the special salt refill indicator irritating, e.g. when using combined detergents with salt replacement substances, you can switch the indicator off.

Note

To avoid damage to the appliance, only switch off the water softening system in the following cases:

- The water hardness is max. 26 °E and you are using combined detergents with salt replacement substances. According to manufacturers, combined detergents with salt replacement substances can generally only be used up to a water hardness of 26 °E without adding special salt.
 - The water hardness is 0 - 8 °E. You do not need to use special salt.
1. Press .
 2. To open the basic settings, press  for approx. 3 seconds.
 3. Press  repeatedly until the display shows "Water hardness".
 4. Press  or  repeatedly until the display shows 0 - 8.
 5. To save the settings, press  for approx. 3 seconds.
- ✓ The water softening system is switched off and the salt refill indicator is deactivated.

Regeneration of the water softening system

In order to obtain fault-free function of the water softening system, the appliance performs regeneration of the water softening system at regular intervals.

Regeneration of the water softening system takes place before the end of the main rinse cycle in all programmes. It will increase the run time and consumption values, e.g. water and electricity.

Overview of consumption values with regeneration the water softening system

Here you can find an overview of the maximum additional run time and consumption values during regeneration of the water softening system.

| | |
|---|------|
| Regeneration of the water softening system after x rinse cycles | |
| Additional run time in minutes | 7 |
| Additional water consumption in litres | 5 |
| Additional power consumption in kWh | 0.05 |

The consumption values specified are laboratory measurements determined in accordance with the currently applicable standard and using the Eco 50° programme and the factory value of the water hardness is set to 16 - 20°E.

Rinse aid system

Rinse aid

For optimum drying results, use rinse aid.

Only use rinse aid for domestic dishwashers.

Adding rinse aid

If the display shows "Please add rinse aid.", add rinse aid. Only use rinse aid for domestic dishwashers.

1. Press the catch on the lid of the dispenser for rinse aid ① and lift ②.

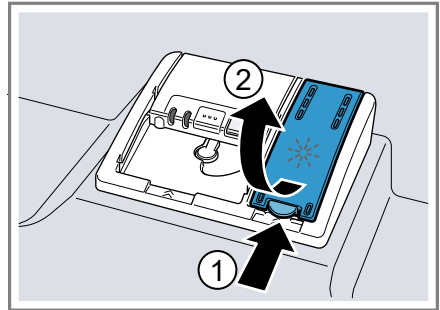

2. Add rinse aid up to the max mark.

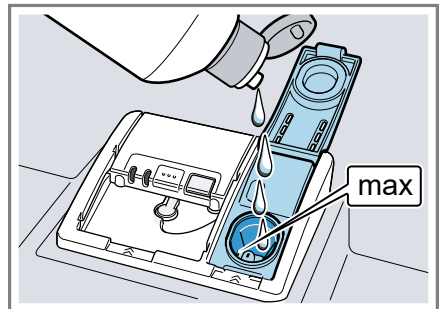

3. If rinse aid spills out, remove it from the tub.



Spilled rinse aid can cause excessive frothing during the wash cycle.

en Detergent

4. Close the lid of the dispenser for rinse aid.
- ✓ The lid clicks into position.

Setting the amount of rinse aid

If there are streaks or water marks on tableware, change the amount of rinse aid.

1. Press \odot .
2. To open the basic settings, press  for approx. 3 seconds.
3. Press \triangleright repeatedly until the display shows "Rinse aid dispenser".
4. Press $-$ or $+$ repeatedly until the right amount of rinse aid has been set.
 - A low setting adds less rinse aid during the wash cycle and reduces streaking on tableware.
 - A higher setting adds more rinse aid during the wash cycle, reduces water marks and improves the drying result.
5. To save the settings, press  for approx. 3 seconds.

Switching the rinse aid system off

If you find the rinse aid refill indicator irritating, e.g. when using combined detergents with a rinse aid component, you can switch the rinse aid system off.

Tip: The function of rinse aid is limited with combined detergents. You will generally get better results using rinse aid.

1. Press \odot .
2. To open the basic settings, press  for approx. 3 seconds.
3. Press \triangleright repeatedly until the display shows "Rinse aid dispenser".

4. Press $-$ or $+$ repeatedly until the display shows 0.
5. To save the settings, press  for approx. 3 seconds.
 - ✓ The rinse aid system is switched off and the rinse aid refill indicator is deactivated.

Detergent

Suitable detergents

Only use detergents that are suitable for dishwashers. Both separate and combined detergents are suitable. For optimum washing and drying results, use separate detergent, adding "Special salt" → Page 27 and "Rinse aid" → Page 29 separately. Modern, powerful detergents mainly use a low-alkaline formulation with enzymes. Enzymes break down starch and remove protein. Oxygen-based bleaching agents are generally used to remove coloured marks, e.g. tea or ketchup.

Note: Follow the manufacturer's instructions for each detergent.

| Detergent | Description |
|------------------|---|
| Tabs | Tabs are suitable for all cleaning functions and do not need to be measured out. With shorter "Programmes" → Page 20 tabs sometimes do not dissolve entirely and leave residues of detergent. This may impair the cleaning effect. |
| Powder detergent | Powder detergent is recommended for shorter "Programmes" → Page 20. The dosage can be adjusted to the level of soiling. |

| Detergent | Description |
|------------------|---|
| Liquid detergent | <p>Liquid detergent works faster and is recommended for shorter "Programmes" → <i>Page 20</i> without PreRinse.</p> <p>Sometimes liquid detergent may leak out despite the detergent dispenser being closed. This is not a fault and is non-critical if you remember the following:</p> <ul style="list-style-type: none"> ■ Only choose a programme without PreRinse. ■ Do not select timer programming for starting the programme. <p>The dosage can be adjusted to the level of soiling.</p> |

Tip: Suitable detergents are available online via our website or from "Customer Service" → *Page 61*.

Separate detergents

Separate detergents are products that do not contain components other than detergent, e.g. powder detergent or liquid detergent.

With powder and liquid detergent the dosage can be individually adjusted to the level of soiling of the tableware.

For better washing and drying results and to avoid damage to the appliance, please additionally use "Special salt" → *Page 27* and "Rinse aid" → *Page 29*.

Combined detergent

Besides conventional separate detergents, a number of products are available with additional functions. These products contain not only detergent but also rinse aid and salt replacement substances (3in1) and,

depending on the combination (4in1, 5in1, ...), additional components such as glass protection or stainless steel cleaner.

According to manufacturers, combined detergents generally only function up to a water hardness of 26 °E. With a water hardness above 26 °E you will need to add special salt and rinse aid. For the best washing and drying results we recommend using special salt and rinse aid from a water hardness of 17 °E. If you are using combined detergent, the washing programme is adjusted automatically to ensure the best possible washing and drying result.

Unsuitable detergents

Do not use detergent which could cause damage to the appliance or present a risk to health.

| Detergent | Description |
|-------------------------------|---|
| Hand washing-up liquid | Hand washing-up liquid can cause increased frothing and damage the appliance. |
| Detergent containing chlorine | Chlorine residue on tableware may present a risk to health. |

Information on detergents

Follow the instructions on detergents in everyday use.

- Detergents marked as "organic" or "ecological" (environmentally friendly) generally contain lower levels of active agents or completely dispense with certain substances. The cleaning effect may be restricted here.
- Set the rinse aid and the water softening system to the separate detergent or combined detergent in use.

en Detergent

- According to manufacturers, combined detergents with salt replacement substances can only be used up to a certain water hardness, usually 26 °E, without adding special salt. For the best washing and drying results we recommend using special salt from a water hardness of 17 °E.
- To prevent sticking, only touch detergents in a water-soluble pouch with dry hands and only ever place them in a dry detergent dispenser.
- Even if the rinse aid and special salt refill indicators light up, washing programmes will run properly with combined detergents.
- The function of rinse aid is limited with combined detergents. You will generally get better results using rinse aid.
- Use tablets with a special drying performance.

Adding detergent

1. To open the detergent dispenser, press the locking latch.

2. Add the detergent to the dry detergent dispenser.

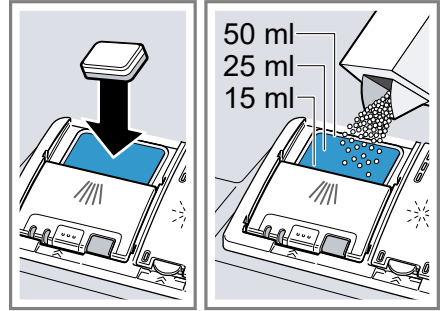

If you are using tablets, one is enough. Insert the tablets in a horizontal position.

If you are using powder or liquid detergent, follow the manufacturer's instructions and quantities for dosage in the detergent dispenser.

20 ml – 25 ml detergent is sufficient for normal soiling. If tableware is only lightly soiled, slightly less than the amount of detergent specified is usually sufficient.

3. Close the lid of the detergent dispenser.

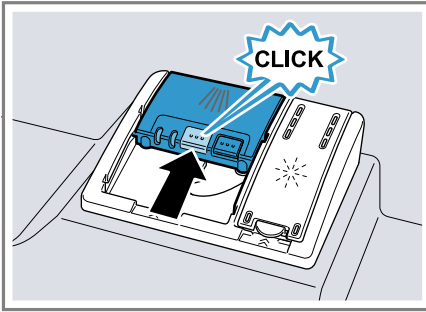

- ✓ The lid clicks into position.
- ✓ The detergent dispenser will open automatically at the optimum time during the programme. Powder or liquid detergent will spread around the washing tank and dissolve there. Tablets will fall into the tablet collecting tray and dissolve in the right dosage. In order to ensure that tablets can dissolve evenly, do not place any other objects in the tablet collecting tray.

Tip: If you use powder detergent and select a program with pre-rinse, you can also add a little detergent to the interior door of the appliance.

Tableware

Only clean tableware that is suitable for dishwashers.

Note: Decorated glassware and parts made of aluminium or silver may fade or discolour with dishwashing. Delicate types of glass may turn cloudy after a few washing cycles.

Damage to glass and tableware

Only put glasses and china in the dishwasher if it is marked as dishwasher-safe by the manufacturer. Avoid damage to glass and tableware.

| Cause | Recommendation |
|---|--|
| <p>The following tableware is not dishwasher-safe:</p> <ul style="list-style-type: none"> ■ Items of cutlery and tableware made from wood ■ Decorated glassware, antique and hand-crafted tableware ■ Plastic parts not resistant to heat ■ Tableware made from copper or tin ■ Tableware soiled with ash, wax, lubricating grease or paint ■ Very small items of tableware | <p>Only put tableware in the dishwasher if it is marked as dishwasher-safe by the manufacturer.</p> |
| <p>The chemical composition of detergent causes damage.</p> | <p>Use a detergent marked by the manufacturer as gentle on tableware.</p> |
| <p>Highly caustic alkaline or highly acidic cleaning solutions, in particular commercial or industrial cleaners, are not safe to use in the dishwasher with aluminium.</p> | <p>If you are using highly caustic alkaline or highly acidic cleaning agents, in particular commercial or industrial cleaning agents, do not put aluminium parts in the dishwasher interior.</p> |

| Cause | Recommendation |
|---|--|
| The water temperature of the programme is too high. | Select a programme with lower temperatures. After the programme has ended, take glassware and cutlery out of the appliance without delay. |

Arrange tableware

Arrange tableware correctly to optimise the dishwashing result and prevent damage to both the appliance and tableware.

Tips

- Using the appliance allows you to save energy and water compared to washing-up by hand.
- See our website for examples of how to load your appliance efficiently, free of charge.
- To save energy and water, load the machine with the number of place settings specified (standard load with tableware and cutlery).
→ "Technical specifications", Page 62
- For better washing and drying results, position items with curves or recesses at an angle so water can run off.

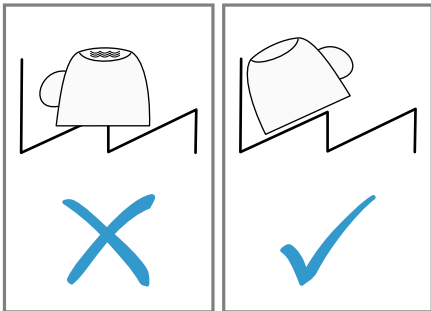

1. Remove large remnants of food from tableware.

To save resources, do not pre-rinse tableware under running water.

2. Observe the following when arranging tableware:
 - Put heavily soiled tableware in the bottom basket, e.g. pans. The more powerful the spray jet, the better the dishwashing result will be.
 - To prevent damage to tableware, arrange it so it is stable and cannot tip over.
 - To prevent injury, arrange cutlery with the points and sharp edges facing down.
 - Position containers with the openings facing down so no water can collect in them.
 - Do not block the spray arms - make sure that they can turn freely.
 - Do not place small parts in the tablet collecting tray and do not block it with tableware so as not to obstruct the lid of the detergent dispenser.

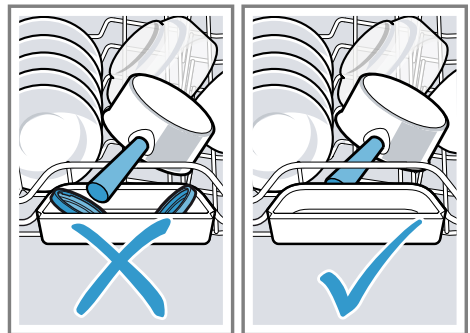

Removing tableware

WARNING **Risk of injury!**

Hot tableware can cause burns to the skin. When hot, tableware is sensitive to shock, may crack and can result in injury.

- ▶ When the programme has ended, do not empty the appliance until the tableware has cooled down for a while.
1. To prevent water dripping on the tableware, unload it starting at the bottom and working up.
 2. Check the washing tank and accessories for soiling and clean if necessary.
→ "Cleaning and servicing", Page 41

Basic operation

Opening appliance door

1. If the electric childproof lock is not activated, press on the upper middle section of the appliance door.
 2. If the electric childproof lock is activated, press on the upper middle section of the appliance door twice with a short interval in between.
- ✓ The appliance door will open automatically.

Switching on the appliance

- ▶ Press .
- The Eco 50° programme is set by default.
The Eco 50° programme is especially environmentally friendly and ideal for normally soiled tableware. It is the most efficient programme

for the combination of energy/water consumption for this type of tableware and evidences conformity with the EU Ecodesign Directive.

If you do not perform any actions on the appliance for 10 minutes, the appliance will automatically switch off.

Setting a programme

To adjust the wash cycle to the soiling level of the tableware, select a suitable programme.

- ▶ Press the right programme button.
→ "Programmes", Page 20
- ✓ The programme is set and the programme button flashes.

Setting additional functions

You can set additional functions to complete the washing programme selected.

Note: The additional functions which can be used depend on the programme selected.

- "Programmes", Page 20
- ▶ Press the button for the relevant additional function.
→ "Additional functions", Page 22
- ✓ The additional function is set and the additional function button flashes.

Setting timer programming

You can delay the start of the programme by up to 24 hours.

1. Press .
2. Press $-$ or $+$ repeatedly until the display shows the right time.

Depending on the setting of the time display, the end of the programme is shown on the display by "Finish in" (e.g. 3h 25min) or

en Basic operation

"Finish at" (e.g. 15:20 hours). You can change this setting in the "Basic settings" → *Page 37*.

3. To activate timer programming, press Start.

Note: To deactivate timer programming, press **Reset 4 sec.** for approx. 4 seconds.

Starting the programme

- ▶ Press Start.
- ✓ The programme has ended when the display shows "Finished".

Notes

- If you want to add more tableware while the appliance is running, do not use the tablet collecting tray as a handle for the top basket. You might touch the partially dissolved tablet.
- You can only change a programme when running if you cancel it.
→ *"Terminate programme"*, *Page 36*
- The appliance switches off automatically 1 minute after the end of the programme to save energy. If you open the appliance door immediately after the programme has ended, the appliance will switch off after 4 seconds.

Interrupting programme

Note: When you open the appliance door once the appliance has heated up, leave the door slightly ajar for a few minutes and then close it. This will help prevent excess pressure building up in the appliance and stop the appliance door bursting open.

1. Open the appliance door carefully.
 2. Press .
- ✓ The programme is saved and the appliance switches off.

3. Press  to resume the programme.
4. Close the appliance door.

Terminate programme

To end a programme early or to switch from a programme that has already started, you will need to cancel it first.

1. Open the appliance door.
2. Press **Reset 4 sec.** for approx. 4 seconds.
3. Close the appliance door.
 - ✓ All displays light up.
 - ✓ As soon as the displays are off, the display shows "Programme was terminated " and then "Finished".
 - ✓ The programme is cancelled and ends after approx. 1 minute.

Display programme information

You can show information about programmes and additional functions on the display.

1. Press .
2. Press the programme button or an additional function.

Switching off appliance

1. Please note the information on "Safe use" → *Page 11*.
2. Press .

Tip: If you press  during the wash cycle, the programme currently running will be interrupted. When you switch the appliance back on, the programme continues automatically.

Basic settings

You can configure the basic settings for your appliance to meet your needs.

Overview of basic settings

The basic settings depend on the features of your appliance.

| Basic setting | Selection | Description |
|---------------------|--|---|
| Time setting | 00:00 - 24:00 | Set the current time. The setting depends on the time format selected. |
| Time format | 12 h 24 h ¹ | Set the time format. |
| Time display | In hours Time ¹ | Set the time display for the end of the programme. "Finish in" shows the remaining time the programme has to run, e.g. 3h 25min. "Finish at" shows the time when the programme will end, e.g. 15:20 hours. |
| Sprache/Language | See selection on the appliance. | Select the menu language. |
| Water hardness | 0 - 62 16 - 20 medium ¹ | Set the water hardness. → "Overview of water hardness settings", Page 27 |
| Rinse aid dispenser | 0 - 6 5 ¹ | Set or switch off the amount of rinse aid to be dispensed. → "Setting the amount of rinse aid", Page 30 |
| Sensor setting | Standard ¹ Sensitive Very sensitive | Set the water sensor for identifying soiling. → "Sensors", Page 13 |
| Extra Dry | on off ¹ | Switch "Extra Dry" on or off for each operation. The temperature is increased during the final rinse for a better drying result. This may increase the running time slightly. Please take care with delicate tableware. |
| Water connection | Cold water ¹ Hot water | Set cold water or hot water connection. Only set the appliance to hot water if this can be prepared with little energy and a suitable installation is available, e.g. solar heating system with circulation line. The water temperature should be at least 40 °C and max. 60 °C. |

¹ Factory setting (may vary according to model)







| Basic setting | Selection | Description |
|------------------|--|---|
| Eco forecast | on off ¹ | Switch EcoCheck on or off. When selecting the programme, the average water consumption and energy consumption is briefly shown on the display. |
| Emotion Light | off On via main switch ¹ On on opening door | Switch the interior lighting of the appliance on or off. When the appliance door is opened, the interior lighting switches off automatically after 10 minutes. |
| Time light | on ¹ off | Switch "Time light" on or off. While the programme is running, status information is projected onto the floor below the appliance door, e.g. the remaining running time. If the base panel is pulled forwards or if the appliance is installed at eye level with the cabinet front fitted flush, the display is not visible. |
| Start programme | Eco 50 ¹ Last selected programme | Set a default programme for when the appliance is switched on. → <i>"Programmes", Page 20</i> |
| Tone volume | Scale with multiple levels. | Set the signal volume at the end of the programme. Level 0 switches the signal tones off. |
| Button volume | Scale with multiple levels | Set the button volume during operation. Level 0 switches the button tones off. |
| Child-proof lock | on off ¹ | Switch the "Electric childproof lock" → <i>Page 12</i> on or off. |
| Open Dry | off On in all programmes On with Eco 50 ¹ | Activate or deactivate automatic opening of the appliance door during the drying phase. If the function has been activated, the running time may increase. → <i>"Open Dry", Page 13</i> |
| Wi-Fi | on off | Switch the wireless network connection on or off. The basic setting "Wi-Fi" is only available once the appliance is connected to the Home Connect app. → <i>"Home Connect ", Page 39</i> |
| Remote Start | off Manual Permanent | Activate or deactivate → <i>"Remote Start □", Page 40</i> . This basic setting is not available until after you have connected the device with the Home Connect app. → <i>"Home Connect ", Page 39</i> |

¹ Factory setting (may vary according to model)







| Basic setting | Selection | Description |
|-----------------|------------------------|---|
| Greeting | on ¹ off | Switch display of the brand name logo on or off when the appliance is switched on. |
| Factory setting | Reset | Restore changed settings to the factory settings. The settings for initial start-up must be configured. |

¹ Factory setting (may vary according to model)

Changing basic settings

1. Open the appliance door.
2. Press .
3. To open the basic settings, press  for approx. 3 seconds.
4. Press  repeatedly until the display shows the required setting.
5. Press  or  repeatedly until the display shows the right value.
You can change several settings.
6. To save the settings, press  for approx. 3 seconds.
7. Close the appliance door.

Setting the time

1. To open the basic settings, press  for approx. 3 seconds.
2. Press  repeatedly until the display shows "Time setting".
3. Press  or  repeatedly until the display shows the required time.
Holding down  and  will change the set values in 10-minute steps.
4. To save the settings, press  for approx. 3 seconds.

Home Connect

This appliance is network-capable. Connect your appliance to a mobile device to control its functions via the Home Connect app. The Home Connect services are not available in every country. The availability of the Home Connect function depends on the availability of Home Connect services in your country. You can find information about this at: www.home-connect.com. To be able to use Home Connect, you must first set up the connection to the WLAN home network (Wi-Fi¹) and to the Home Connect app.

- → *"Connecting the appliance to WLAN home network (Wi-Fi)", Page 40*

The Home Connect app guides you through the entire login process. Follow the instructions in the Home Connect app to configure the settings.

Tips

- Please consult the documents supplied by Home Connect.
- Please also follow the instructions in the Home Connect app.

Note: Please note the safety precautions in this instruction manual and make sure that they are also observed when operating the appliance via the Home Connect app.

→ *"Safety", Page 4*

¹ Wi-Fi is a registered trademark of the Wi-Fi Alliance.

Home Connect quick start

Connect your appliance to a mobile device quickly and easily.

Installing app

1. Install the Home Connect app on your mobile device.



2. Start the Home Connect app and set up access for Home Connect. The Home Connect app guides you through the entire login process.

Connecting the appliance to WLAN home network (Wi-Fi)

Requirements

- The Home Connect app is installed on your mobile device.
 - Wi-Fi is activated on the router.
 - The appliance receives signals from the WLAN home network (Wi-Fi) at its installation location.
1. With the help of the Home Connect app scan the QR code.



2. Follow the instructions in the Home Connect app.

Home Connect settings

Adapt Home Connect to your needs. You can find the Home Connect settings in the basic settings for your appliance. Which settings the display shows will depend on whether Home Connect has been set up and whether the appliance is connected to your home network.

Remote Start



You can use the Home Connect app to start the appliance with your mobile device.

Tip: If you select "Permanent" in the "Basic settings" → *Page 38* of this function, the function is permanently activated and you can start your appliance with a mobile device at any time.

Activating Remote Start

When you have selected "Manual" in the basic settings of this function, activate the function on your appliance.

Requirements

- The appliance is connected to your WLAN home network.
 - The appliance is connected to the Home Connect app.
 - "Manual" is selected in the "Basic settings" → *Page 38* of this function.
 - A programme is selected.
- ▶ Press .
- If you open the appliance door, the function is automatically deactivated.
- ✓  button lights up.

Tip: To deactivate the function, press .

Remote Diagnostics

Customer Service can use Remote Diagnostics to access your appliance if you contact them, have your appliance connected to the Home Connect server and if Remote Diagnostics is available in the country in which you are using the appliance.

Tip: For further information and details about the availability of Remote Diagnostics in your country, please visit the service/support section of your local website: www.home-connect.com

Software update

You can use this function to update the software of your appliance, e.g. for optimisation, troubleshooting or safety-relevant updating. The Home Connect app informs you about available software updates.

Data protection

Please see the information on data protection.

The first time your appliance is registered on a home network connected to the Internet, your appliance will transmit the following types of data to the Home Connect server (initial registration):

- Unique appliance identification (consisting of appliance codes as well as the MAC address of the Wi-Fi communication module installed).
- Security certificate of the Wi-Fi communication module (to ensure a secure data connection).
- The current software and hardware version of your appliance.
- Status of any previous reset to factory settings.

This initial registration prepares the Home Connect functions for use and is only required when you want to use the Home Connect functions for the first time.

Note: Please note that the Home Connect functions can only be utilised with the Home Connect app. Information on data protection can be retrieved in the Home Connect app.

Cleaning and servicing

To keep your appliance working efficiently for a long time, it is important to clean and maintain it carefully.

Cleaning the tub

WARNING

Risk of harm to health!

Using detergents containing chlorine may result in harm to health.

- ▶ Never use detergents containing chlorine.
1. Remove any coarse soiling in the interior with a damp cloth.
 2. Add detergent to the detergent dispenser.
 3. Select the programme with the highest temperature.
→ "Programmes", Page 20
 4. "Start the programme without tableware." → Page 36

Cleaning products

Only use suitable cleaning products to clean your appliance.
→ "Safe use", Page 11

Tip: You can get our tested and approved Dishwasher Care and Machine Cleaner for Dishwashers online at <https://www.neff-home.com/store> or from customer service.

Tips on appliance care

Follow the tips on appliance care to make sure your appliance functions properly at all times.

| Action | Benefit |
|---|---|
| Wipe the door seals, the front of the dishwasher and the con- | This ensures the parts of the appliance will remain clean and hygienic. |

Easy Clean Easy Clean

Deposits, e.g. from remnants of food and limescale, can cause your appliance to malfunction. To avoid such faults and reduce odours, we recommend cleaning your appliance at regular intervals.

Easy Clean combined with machine care products and machine cleaners is the right programme for the care of your appliance.

| Phase | Removal of | Detergent | Placement |
|-------|----------------------------|---|---|
| 1 | Grease and limescale | Liquid machine care product or machine descaler in powder form. | Appliance interior, e.g. bottle hung in the cutlery basket or powder in the interior. |
| 2 | Food remnants and deposits | Machine cleaner | Detergent dispenser |

To ensure optimum cleaning performance, the programme doses the detergents independently of each another during the relevant cleaning phase. Correct placement of the detergents is necessary here.

Run Easy Clean without tableware if the indicator for Easy Clean lights up on the control panel or if advised to do so by the display. The indicator will go out after you have run Easy Clean. If your appliance does not have a reminder function, we recommend performing Machine Care every 2 months.

| Action | Benefit |
|---|--------------------------------------|
| Control panel regularly using a damp cloth and washing-up liquid. | |
| If the appliance is not going to be used for a while, leave the door slightly ajar. | This will prevent unpleasant odours. |

Tip: You can get our tested and approved Dishwasher Care and Machine Cleaner for Dishwashers online at <https://www.neff-home.com/store> or from customer service.

Easy Clean is a programme which removes various deposits in one washing cycle. Cleaning takes place in two phases:

Running Easy Clean

Notes

- Run the Easy Clean programme without any tableware in the dishwasher.
- Only use machine care products and machine cleaners specially designed for dishwashers.
- Make sure that there are no aluminium parts, e.g. extractor hood grease filters or aluminium pans, in the interior of the appliance.
- If you have not run Easy Clean after 3 washing cycles, the indicator for Easy Clean will go out automatically.

- For optimum cleaning performance, ensure the correct placement of cleaners.
- Follow the safety instructions given on the packagings of the machine care products and machine cleaners.

1. Remove any coarse soiling in the interior with a damp cloth.
2. Clean the filters.
3. Place the machine care product in the appliance interior.

Only use machine care products specially designed for dishwashers.

4. Pour the machine cleaner into the detergent dispenser until it is filled completely.

Do not place any additional machine cleaner in the appliance interior.

5. Press Easy Clean.
6. Press Start.
 - ✓ Easy Clean is run.
 - ✓ Once the programme has ended, the indicator for Easy Clean goes out.

Filter system

The filter system removes coarse soiling from the dishwashing cycle.

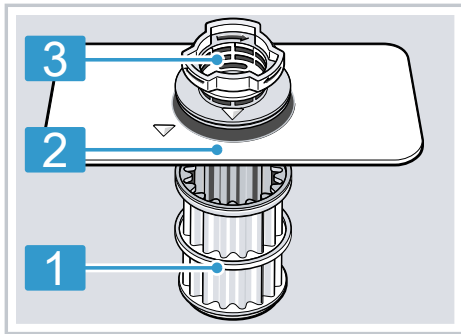

1 Micro filter

2 Fine filter

3 Coarse filter

Cleaning filters

Soiling in the dishwashing water may block the filters.

1. After each wash check the filters for residue.
2. Turn the coarse filter anticlockwise ① and remove the filter system ②.
 - Check that no foreign objects fall into the sump.

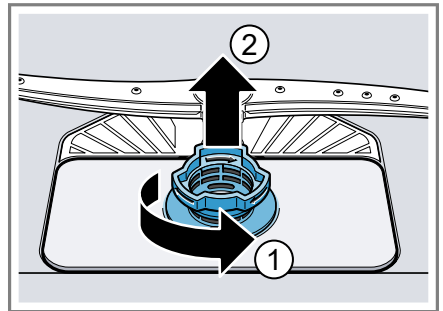

3. Pull down the micro filter to remove.

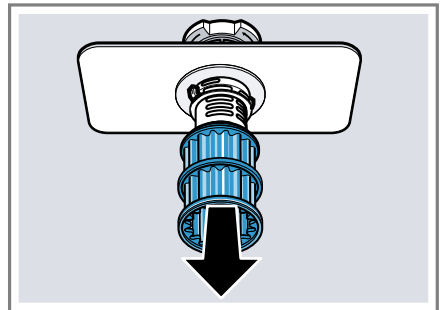

4. Press the locking catches ① together and lift the coarse filter out ②.

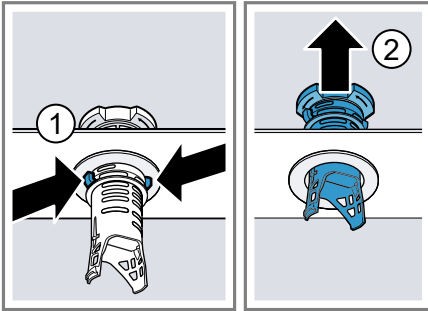

5. Clean the filter elements under running water.
Carefully clean the rim of dirt between the coarse and the fine filter.

6. Re-assemble the filter system.
Make sure that the locking catches on the coarse filter click into position.

7. Insert the filter system into the appliance and turn the coarse filter clockwise.
 - Make sure that the arrow markings match up.

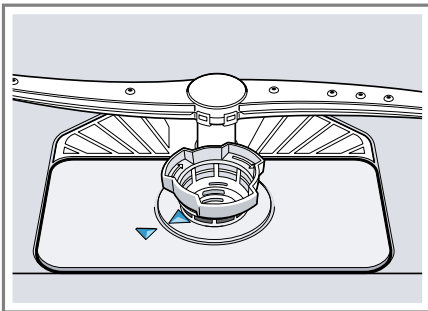

Cleaning spray arms

Limescale and soiling in the dish-washing water may block the nozzles and bearings on the spray arms. Clean the spray arms regularly.

1. Unscrew the upper spray arm ① and pull down to remove ②.

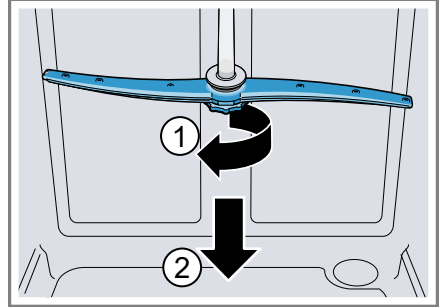

2. Pull up the lower spray arm to remove.

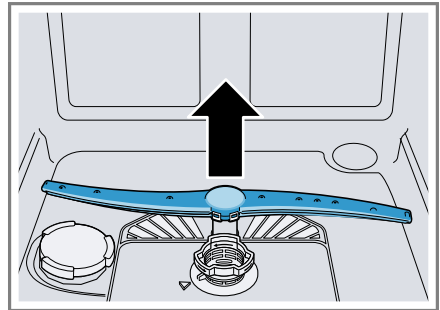

3. Check the outlet nozzles on the spray arms for blockages under running water and remove any foreign bodies.
4. Insert the lower spray arm.
 - ✓ The spray arm clicks into position.
5. Insert the upper spray arm and screw it firmly in place.

Troubleshooting

You can rectify minor faults on your appliance yourself. Read the troubleshooting information before contacting after-sales service. This will avoid unnecessary costs.

WARNING

Risk of electric shock!

Incorrect repairs are dangerous.

- ▶ Repairs to the appliance should only be carried out by trained specialist staff.
- ▶ Only use genuine spare parts when repairing the appliance.
- ▶ If the power cord of this appliance is damaged, it must be replaced with a special connection cable, which is available from the manufacturer or his Customer Service.

Appliance safety

| Fault | Cause | Troubleshooting |
|---|--|--|
| Appliance door opens accidentally. | Automatic door opening activated accidentally. | ▶ To prevent the appliance door opening accidentally, activate the childproof lock. |
| Appliance door does not open at the end of the programme. | Automatic door opening is not activated. | ▶ Activate the automatic door opening. → "Overview of basic settings", Page 37 |
| | Childproof lock is activated. | ▶ Deactivate the childproof lock. |
| Appliance door and door seal are soiled. | Door is not correctly adjusted. | ▶ Adjust the appliance door as described in the installation instructions. The door gap must be at least 70 mm - 100 mm. |
| | Wrong screws used to adjust the door gap. | ▶ Use size 4X30 bolts to adjust the door gap. The bolts are included in the scope of supply. If you use bolts that are too long, this can deactivate the function of automatic door opening. |
| The safety device switches off automatic door opening. | | ▶ Call "Customer Service." → Page 61 |

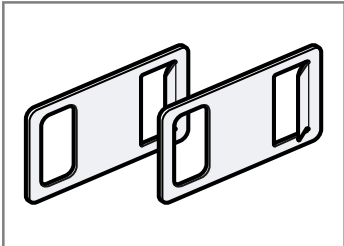
| Fault | Cause | Troubleshooting |
|--|--|--|
| Appliance door does not open at the end of the programme. | Appliance door brushes against the appliance or kitchen cabinets | ▶ Install the appliance correctly as described in the installation instructions and align. |
| Appliance door opens too wide at the end of the programme. | Door is not correctly adjusted. | ▶ Adjust the appliance door as described in the installation instructions. The door gap must be at least 70 mm - 100 mm. |
| | Wrong screws used to adjust the door gap. | ▶ Use size 4X30 bolts to adjust the door gap. The bolts are included in the scope of supply. If you use bolts that are too long, this can deactivate the function of automatic door opening. |
| Appliance door does not open. | Childproof lock is activated. | ▶ Press the top of the door in the middle twice in quick succession. |
| | Door is not correctly adjusted. | ▶ Adjust the appliance door as described in the installation instructions. |
| | Appliance has no power. | ▶ Check the mains plug and fuses. 1. Position the emergency release supplied on the top right and left of the cabinet panel. |
| | |  |
| | | 2. Open the appliance door by pulling lightly. |
| | Appliance door and door seal are soiled. | ▶ Clean the appliance door and door seal with a damp cloth and a little washing-up liquid. |
| | Automatic door opening is not in home position. | ▶ Wait one second after closing the appliance door. |



| Fault | Cause | Troubleshooting |
|---|---------------------------------|--|
| Appliance door opens too wide when activated. | Door is not correctly adjusted. | ▶ Adjust the appliance door as described in the installation instructions. |

Error code / Fault display / Signal

| Fault | Cause | Troubleshooting |
|---|---|---|
| E:2060 lights up. | Appliance has detected calcified heating element. | <ol style="list-style-type: none"> 1. Descale the appliance. 2. Operate the appliance with the water softening system.¹ |
| E:2130 lights up. | Intake opening of Zeolith container is covered by items of tableware. | ▶ Re-arrange the tableware in the appliance so the "Intake opening of the Zeolith container " → <i>Page 16</i> is no longer obstructed. |
| E:3000 lights up. | Water protection system is activated. | <ol style="list-style-type: none"> 1. Turn off the water tap. 2. Call "Customer Service" → <i>Page 61</i>. |
| E:3100 lights up. | Water protection system is activated. | <ol style="list-style-type: none"> 1. Turn off the water tap. 2. Call "Customer Service" → <i>Page 61</i>. |
| E:3200 or indicator for water supply lights up. | Supply hose is kinked. | ▶ Install the supply hose without kinks. |
| | Water tap is turned off. | ▶ Turn on the water tap. |
| | Water tap is jammed or furred up. | ▶ Turn on the water tap. The flow rate must be at least 10 l/min when the water supply is open. |
| | The filters in the water connection of the supply or AquaStop hose are blocked. | <ol style="list-style-type: none"> 1. Switch off the appliance. 2. Pull out the mains plug. 3. Turn off the water tap. 4. Unscrew the water connection. |

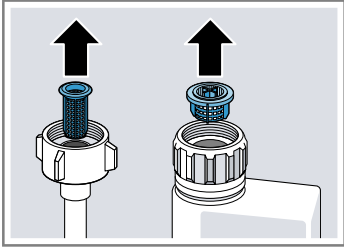
¹ Depending on the appliance specifications

| Fault | Cause | Troubleshooting |
|---|---|--|
| E:3200 or indicator for water supply lights up. | | <ol style="list-style-type: none"> 5. Remove the filter from the supply hose |
| | |  |
| | | <ol style="list-style-type: none"> 6. Clean the filter. 7. Re-insert the filter in the supply hose. 8. Screw the water connection back on. 9. Check the water connection for leaks. 10. Restore the power supply. 11. Switch the appliance on. |
| E:3400 lights up. | Water is continuously running into the appliance. | <ol style="list-style-type: none"> 1. Turn off the water tap. 2. Call "Customer Service" → <i>Page 61</i>. |
| E:6102 lights up. | Wastewater pump is blocked. | <ul style="list-style-type: none"> ▶ Clean the wastewater pump. → <i>"Clean wastewater pump", Page 60</i> |
| | | <ul style="list-style-type: none"> ▶ Secure the cover of the "Wastewater pump" → <i>Page 60</i> so it clicks into position. |
| E:6103 lights up. Water is not drained. | Wastewater hose is blocked or kinked. | <ol style="list-style-type: none"> 1. Reposition the wastewater hose without kinks. 2. Remove residues. |
| | | <ul style="list-style-type: none"> ▶ Check the connection to the siphon and open if necessary. |
| | | <ul style="list-style-type: none"> ▶ Secure the cover of the "Wastewater pump" → <i>Page 60</i> so it clicks into position. |

| Fault | Cause | Troubleshooting |
|---|--------------------------------|---|
| E:9001 lights up. | Mains voltage is too low. | This is not a fault on the appliance. <ol style="list-style-type: none"> 1. Contact an electrician. 2. Have the mains voltage and electrical installation checked by an electrician. |
| E:9240 lights up. | Filters are soiled or blocked. | ▶ Clean the filters. → "Cleaning filters", Page 43 |
| A different error code appears in the display window. E:0100 to E:9010 | A technical fault is present. | <ol style="list-style-type: none"> 1. Press . 2. Unplug the appliance or switch off the fuse. 3. Wait at least 2 minutes. 4. Insert the mains plug of the appliance in a socket or switch on the fuse. 5. Switch the appliance on. 6. If the problem occurs again: <ul style="list-style-type: none"> - Press . - Turn off the water tap. - Pull out the mains plug. - Contact "Customer Service" → Page 61 and give the error code. |

Washing results

| Fault | Cause | Troubleshooting |
|-----------------------|--|---|
| Tableware is not dry. | No rinse aid used or dosage set too low. | <ol style="list-style-type: none"> 1. Add "Rinse aid" → Page 29. 2. Set the amount of rinse aid to be dispensed. → "Setting the amount of rinse aid", Page 30 |
| | Programme or programme option has no drying phase, or the drying phase is too brief. | ▶ "Select a programme with drying, e.g. intensive, strong or ECO programme." → Page 20 Some option buttons decrease the drying result, e.g. varioSpeed. |

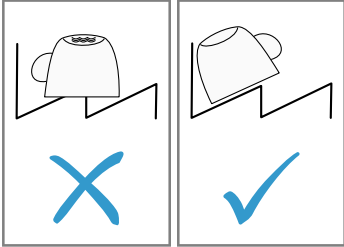
| Fault | Cause | Troubleshooting |
|--|--|---|
| Tableware is not dry. | Water collects in recesses of the tableware or cutlery. | <ul style="list-style-type: none"> ▶ Position tableware at an angle where possible. |
| | |  |
| | | <ul style="list-style-type: none"> 1. Use rinse aid to improve drying performance. 2. Use a different combined detergent with a better drying performance. |
| | | <ul style="list-style-type: none"> ▶ Activate "Extra Dry" → <i>Page 37</i>. |
| Extra Dry not activated to improve drying performance. | | |
| Tableware removed too early or drying process not yet ended. | | |
| | | <ul style="list-style-type: none"> 1. Wait until the programme ends. 2. Only remove tableware 30 minutes after the programme has ended. |
| Rinse aid used has a limited drying performance. | | |
| | | <ul style="list-style-type: none"> ▶ Use a name-brand rinse aid. Eco products may have limited effectiveness. |
| Appliance door does not open automatically at the end of the programme | | |
| | | <ul style="list-style-type: none"> ▶ Adjust the appliance door as described in the installation instructions. The door gap must be at least 70 mm - 100 mm. |
| Plastic tableware is not dry. | Not a fault. As plastic does not store heat so well, it also does not dry as well. | <ul style="list-style-type: none"> ▶ No remedial action possible. |
| Cutlery is not dry. | Cutlery not arranged properly in the cutlery basket or cutlery drawer. | <p>Droplets can form on the cutlery contact points.</p> <ul style="list-style-type: none"> 1. "Arrange cutlery individually where possible." → <i>Page 34</i> 2. Avoid points of contact. |

| Fault | Cause | Troubleshooting |
|--|--|---|
| Appliance interior still wet after wash cycle. | Not a fault. The condensation drying principle causes water droplets in the tub – they are indeed desirable here. The moisture in the air condenses on the inside walls, runs off and is pumped out. | No action required. |
| Remnants of food on tableware. | Tableware is placed too close together or basket is overfilled. | <ol style="list-style-type: none"> 1. Arrange tableware with sufficient space in between. The spray jets must reach the surfaces of the tableware. 2. Avoid points of contact. |
| | Spray arm rotation is blocked. | ▶ Arrange tableware so that it does not obstruct spray arm rotation. |
| | Spray arm nozzles are blocked. | ▶ Clean the "Spray arms" → <i>Page 44</i> . |
| | Filters are soiled. | ▶ Clean the filters. → <i>"Cleaning filters", Page 43</i> |
| | Filters are inserted incorrectly and/or not engaged. | <ol style="list-style-type: none"> 1. Insert the filters properly. → <i>"Filter system", Page 43</i> 2. Engage the filters. |
| | Washing programme selected too weak. | <ul style="list-style-type: none"> ▶ Select a more intensive washing programme. → <i>"Programmes", Page 20</i> ▶ Adjust the sensitivity of the sensors. → <i>"Sensors", Page 13</i> |
| | Tableware has been pre-cleaned too intensely. The sensors chose a weaker programme. Stubborn soiling cannot be entirely removed. | <ul style="list-style-type: none"> ▶ Only remove large remnants of food and do not prerinse tableware. ▶ Adjust the sensitivity of the sensors. → <i>"Sensors", Page 13</i> |
| | Tall narrow receptacles in corner areas are not rinsed adequately. | ▶ Do not position tall narrow receptacles at too great an angle or in corner areas. |
| | Top baskets on right and left are not set to same height. | ▶ Set the top baskets on the left and right to the same level. |

| Fault | Cause | Troubleshooting |
|---|--|---|
| Detergent residue in the appliance | Lid of the detergent dispenser is blocked by items of tableware parts and will not open. | <ol style="list-style-type: none"> 1. Arrange tableware in the top basket tableware so the tab collecting tray is not obstructed by tableware. → <i>"Arrange tableware"</i>, Page 34 Items of tableware are blocking the dispenser lid. 2. Do not place tableware or fragrance dispensers in the tablet collecting tray. |
| | The lid of the detergent dispenser is blocked by the tab and will not open. | ▶ Position the tab in the detergent dispenser crosswise, not vertically. |
| | Tabs are used in the quick or short programme. Dissolving time of the tab is not attained. | ▶ Select a more intensive "Programme" → Page 20 or use "Powder detergent" → Page 30. |
| | Washing effect and dissolving performance are reduced after a prolonged storage time or detergent is very lumpy. | ▶ Change your "detergent" → Page 30. |
| Water marks on plastic parts. | Due to laws of physics droplet formation on plastic surfaces is unavoidable. After drying water marks are visible. | <ul style="list-style-type: none"> ▶ Select a more intensive programme. → <i>"Programmes"</i>, Page 20 ▶ Position tableware at an angle. → <i>"Arrange tableware"</i>, Page 34 ▶ Use rinse aid. → <i>"Rinse aid"</i>, Page 29 ▶ Set the water softening system higher. |
| Wipeable or water-soluble coatings are present inside the appliance or on the door. | Detergent substances are deposited there. These coatings cannot generally be removed with chemicals. | <ul style="list-style-type: none"> ▶ Change your "detergent" → Page 30. ▶ Clean the appliance mechanically. |
| | White coating is deposited in the appliance interior. | <ol style="list-style-type: none"> 1. Set the water softening system correctly. In most cases you will need to increase the setting. 2. Change your detergent if required. |
| | Special salt dispenser is not screwed tight. | ▶ Screw the special salt dispenser tight. |

| Fault | Cause | Troubleshooting |
|--|--|--|
| Stubborn white coatings are present on tableware, inside the appliance or the door. | Detergent substances are deposited there. These coatings cannot generally be removed with chemicals. | <ul style="list-style-type: none"> ▶ Change your "detergent" → <i>Page 30</i>. ▶ Clean the appliance mechanically. |
| | The hardness range is set incorrectly or the water hardness is greater than 62 °E (8,9 mmol/l). | <ul style="list-style-type: none"> ▶ Set the Water softening system to the water hardness or add special salt. |
| | 3in1/organic/eco detergent is not effective enough. | <ul style="list-style-type: none"> ▶ Set the Water softening system to the water hardness and use separate detergents (proprietary detergent, special salt, rinse aid). |
| | Too little detergent is being used. | <ul style="list-style-type: none"> ▶ Increase the amount of detergent used or change "Detergent " → <i>Page 30</i>. |
| | Washing programme selected too weak. | <ul style="list-style-type: none"> ▶ Select a more intensive washing programme. → <i>"Programmes", Page 20</i> ▶ Adjust the sensitivity of the sensors. → <i>"Sensors", Page 13</i> |
| Tea residue or lipstick marks on tableware. | Washing temperature is too low. | <ul style="list-style-type: none"> ▶ Select a programme with a higher washing temperature. → <i>"Programmes", Page 20</i> |
| | Too little detergent is being used or is unsuitable. | <ul style="list-style-type: none"> ▶ Use a suitable "Detergent " → <i>Page 30</i> and follow the manufacturer's instructions for the amount to be used. |
| | Tableware has been pre-cleaned too intensely. The sensors chose a weaker programme. Stubborn soiling cannot be entirely removed. | <ul style="list-style-type: none"> ▶ Only remove large remnants of food and do not pre-rinse tableware. ▶ Adjust the sensitivity of the sensors. → <i>"Sensors", Page 13</i> |
| Coloured coatings (blue, yellow, brown) that are difficult or impossible to remove are present inside the appliance or on stainless steel tableware. | The formation of films is due to substances contained in vegetables (cabbage, celery, potatoes, noodles, etc.) or tap water (manganese). | <ul style="list-style-type: none"> ▶ Clean the appliance. You can remove deposits with "Mechanical cleaning" → <i>Page 41</i> or a machine cleaning product. It may not always be possible to completely remove deposits but they are harmless to health. |
| | The formation of films is due to metal components on silver or aluminium tableware. | <ul style="list-style-type: none"> ▶ Clean the appliance. |

| Fault | Cause | Troubleshooting |
|--|--|--|
| Coloured coatings (blue, yellow, brown) that are difficult or impossible to remove are present inside the appliance or on stainless steel tableware. | | You can remove deposits with "Mechanical cleaning" → <i>Page 41</i> or a machine cleaning product. It may not always be possible to completely remove deposits but they are harmless to health. |
| Coloured deposits (yellow, orange, brown) that are easy to remove are present inside the appliance (mainly at the bottom). | The formation of films is due to ingredients of food remnants and tap water (limescale) "soaplike". | <ol style="list-style-type: none"> 1. Check the setting of the water softening system. 2. Add special salt. → <i>"Adding special salt", Page 27</i> 3. If you are using combined detergents (tabs), activate the water softening system. Follow the information about detergents. → <i>"Information on detergents", Page 31</i> |
| Plastic parts inside the appliance are discoloured. | Plastic parts inside the appliance may become discoloured during the life of the dishwasher. | ▶ Discolouration can come about and will not impair functioning of the appliance. |
| Plastic parts are discoloured. | Washing temperature is too low. | ▶ Select a programme with a higher washing temperature. → <i>"Programmes", Page 20</i> |
| | Tableware has been pre-cleaned too intensely. The sensors chose a weaker programme. Stubborn soiling cannot be entirely removed. | <ul style="list-style-type: none"> ▶ Only remove large remnants of food and do not prerinse tableware. ▶ Adjust the sensitivity of the sensors. → <i>"Sensors", Page 13</i> |
| Removable streaks are present on glasses, glassware with a metallic appearance and cutlery. | Amount of rinse aid to be dispensed is set too high. | ▶ Set the rinse aid system to a lower setting. |
| | No rinse aid has been added. | ▶ → <i>"Adding rinse aid", Page 29</i> |
| | Detergent residue is present in the final rinse. Lid of the detergent dispenser is blocked by tableware items and will not open fully. | <ol style="list-style-type: none"> 1. Arrange tableware in the top basket tableware so the tab collecting tray is not obstructed by tableware. → <i>"Arrange tableware", Page 34</i> Items of tableware are blocking the dispenser lid. 2. Do not place tableware or fragrance dispensers in the tablet collecting tray. |

| Fault | Cause | Troubleshooting |
|---|--|--|
| Removable streaks are present on glasses, glassware with a metallic appearance and cutlery. | Tableware has been pre-cleaned too intensely. The sensors chose a weaker programme. Stubborn soiling cannot be entirely removed. | <ul style="list-style-type: none"> ▶ Only remove large remnants of food and do not prerinse tableware. ▶ Adjust the sensitivity of the sensors. → <i>"Sensors", Page 13</i> |
| Irreversible clouding of glassware. | Glasses are not dishwasher-proof, only suitable for dishwashers. | <ul style="list-style-type: none"> ▶ Use dishwasher-proof glasses. Glasses are usually only suitable for use in a dishwasher, i.e. long-term wear or long-term changes must be expected. ▶ Avoid a lengthy steam phase (standing time after wash cycle ends). ▶ Use a programme with a lower temperature. → <i>"Programmes", Page 20</i> ▶ Set the softening system to the water hardness. ▶ Use detergent with a glass protection component. |
| Rust spots on cutlery. | Cutlery is not sufficiently rust-resistant. Knife blades are often more severely affected. | <ul style="list-style-type: none"> ▶ Use rust-resistant tableware. |
| | Cutlery may also rust if washed together with rusting items. | <ul style="list-style-type: none"> ▶ Do not wash rusting items. |
| | Salt content in washing water is too high. | <ol style="list-style-type: none"> 1. Remove any spilled special salt from the tub. 2. Screw the cap of the special salt dispenser on tight. |
| Detergent residue is present in the detergent dispenser or the tablet collecting tray. | Spray arms were blocked by tableware so detergent was not rinsed out. | <ul style="list-style-type: none"> ▶ Check that the spray arms are not blocked and can rotate freely. |
| | Detergent dispenser was damp when detergent was added. | <ul style="list-style-type: none"> ▶ Only add detergent to a detergent dispenser when dry. |
| Excessive formation of foam occurs. | Hand washing-up liquid is present in dispenser for rinse aid. | <ul style="list-style-type: none"> ▶ Immediately add rinse aid to the dispenser. → <i>"Adding rinse aid", Page 29</i> |
| | Rinse aid has been spilled. | <ul style="list-style-type: none"> ▶ Remove the rinse aid with a cloth. |



| Fault | Cause | Troubleshooting |
|-------------------------------------|--|----------------------------------|
| Excessive formation of foam occurs. | Detergent or appliance care product used causes excessive foaming. | ▶ Change the brand of detergent. |

Home Connect problem

| Fault | Cause | Troubleshooting |
|--|--|--|
| Connection to home network is not established. | WLAN on router is not active. | ▶ Check the wireless network connection of your router. |
| WLAN display is flashing. | Connection to home network is not available. | ▶ Activate the wireless network connection on your router. |
| Home Connect cannot be implemented correctly. | Home Connect set incorrectly. | ▶ Please consult the documents supplied for Home Connect. |
| | Technical fault is present. | ▶ Please consult the information about support in the documents supplied for Home Connect. |

Information on display panel

| Fault | Cause | Troubleshooting |
|--|--|---|
| Special salt refill indicator lights up. | Insufficient special salt. | ▶ Add "Special salt" → <i>Page 27</i> . |
| | Sensor does not detect special salt tablets. | ▶ Do not use special salt tablets. |
| Refill indicator for special salt does not light up. | Water softening system is switched off. | ▶ Setting the water softening system |
| Refill indicator for rinse aid lights up. | Insufficient rinse aid. | 1. Add "Rinse aid" → <i>Page 29</i> . |
| | | 2. Set the amount of rinse aid to be dispensed. → " <i>Setting the amount of rinse aid</i> ", <i>Page 30</i> |
| Refill indicator for rinse aid does not light up. | Rinse aid system is switched off. | ▶ Set the amount of rinse aid to be dispensed. |

Malfunctions

| Fault | Cause | Troubleshooting |
|---|---|--|
| Water is left in the appliance at the end of the programme. | Filter system or area under the filters is blocked. | 1. Clean the "Filters" → <i>Page 43</i> . 2. Clean the "Wastewater pump" → <i>Page 60</i> . |
| | Programme has not yet ended. | ▶ Wait until the programme ends or cancel the programme with Reset . |

| Fault | Cause | Troubleshooting |
|---|---|--|
| Water is left in the appliance at the end of the programme. | | ▶ → "Terminate programme", Page 36 |
| Appliance cannot be switched on or operated. | Software update is taking place. | ▶ Wait until the software update has finished. |
| | Appliance functions have failed. | <ol style="list-style-type: none"> 1. Pull out the mains plug or switch off the fuse. 2. Wait at least 2 minutes. 3. Connect the appliance to the power supply. 4. Switch the appliance on. |
| Appliance does not start. | The mains fuse has tripped. | ▶ Check the relevant fuse. |
| | Mains cable is not inserted. | <ol style="list-style-type: none"> 1. Check whether the socket works. 2. Check whether the mains cable is properly inserted in the socket and on the rear of the appliance. |
| | Appliance door is not closed properly. | ▶ Close the appliance door. |
| Programme starts automatically. | You did not wait until programme ended. | ▶ → "Terminate programme", Page 36 |
| Appliance stops during the programme or cuts out. | Appliance door is not closed properly. | ▶ Close the appliance door. |
| | Power and/or water supply has been interrupted. | <ol style="list-style-type: none"> 1. Check the power supply. 2. Check the water supply. |
| | Top basket is pressing against inner door and preventing appliance door from being closed securely. | <p>▶ Check whether the rear panel of the appliance is being pressed in by a socket or hose holder that has not been removed.</p> <p>▶ Arrange the tableware so that no parts project beyond the basket and prevent the appliance door from closing properly.</p> |

| Fault | Cause | Troubleshooting |
|------------------------------|------------------------------------|---|
| All LEDs lit up or flashing. | Electronics have detected a fault. | <ol style="list-style-type: none"> 1. Press the main switch button for approx. 4 seconds. → "Controls", Page 17 The appliance is reset and restarted. 2. If the problem occurs again: <ul style="list-style-type: none"> – Switch off the appliance. – Pull out the mains plug or switch off the fuse in the fuse box. – Wait at least 2 minutes. – Switch on the fuse in the fuse box or insert the mains plug. – Switch the appliance on. 3. If the problem occurs again: <ul style="list-style-type: none"> – Contact customer service. → "Customer Service", Page 61 |

Mechanical damage

| Fault | Cause | Troubleshooting |
|--|---|---|
| Appliance door cannot be closed. | Door lock has been activated. | ▶ Close the appliance door with greater force. |
| | Door cannot be closed due to installation method. | ▶ Check whether the appliance has been installed properly. When closed, the appliance door, its decor or attached parts should not knock against adjacent cabinets or the worktop. |
| | Automatic door opening is not in home position. | ▶ Wait for a second after opening the appliance door. |
| Lid on the detergent dispenser cannot be closed. | Detergent dispenser or lid are blocked by sticky detergent residue. | ▶ Remove detergent residue. |

Noise

| Fault | Cause | Troubleshooting |
|--|--|--|
| Filling valves making knocking noises. | Caused by the domestic installation. No appliance fault present. Does not affect functioning of the appliance. | ▶ Can only be remedied in the domestic installation. |

| Fault | Cause | Troubleshooting |
|-----------------------------|---|---|
| Knocking or rattling noise. | Spray arm is striking tableware. | ▶ Arrange tableware so that the spray arms do not strike tableware. |
| | With a small load the water jets directly strike against the tub. | ▶ Distribute the tableware evenly. ▶ Load the appliance with more tableware. |
| | Light items of tableware move about during the wash cycle. | ▶ Position light items of tableware securely. |

Clean wastewater pump

Large remnants of food or foreign bodies can block the waste water pump. As soon as the rinsing water no longer drains properly, the waste water pump must be cleaned.

WARNING **Risk of injury!**

Sharp and pointed objects or fragments of glass may block the waste water pump and cause injury.

- ▶ Remove any foreign bodies carefully.
1. Disconnect the appliance from the power supply.
 2. Remove the top and bottom basket.
 3. Remove the filter system.
 4. Scoop out any water.
Use a sponge if necessary.
 5. Prise off the pump cover using a spoon and grip it by the crosspiece.

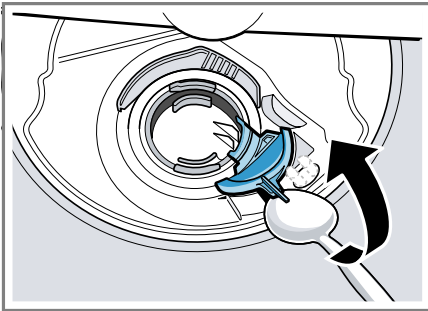

6. Lift the pump cover inwards at an angle and remove.
 - ✓ You can now reach the impeller with your hand.
7. Remove any remnants of food and foreign bodies in the area of the impeller.

8. Insert the pump cover ① and press down ②.

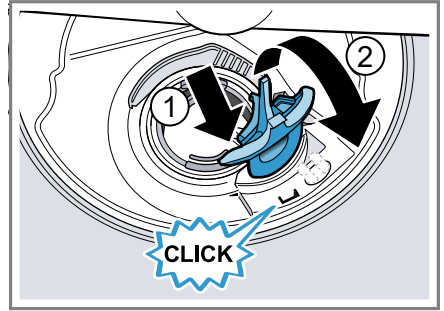

- ✓ The pump cover clicks into position.
9. Install the filter system.
 10. Insert the top and bottom basket.

Transportation, storage and disposal

You can find out here how to prepare your appliance for transportation and storage. You will also find out how to dispose of old appliances.

Removing the appliance

1. Disconnect the appliance from the mains power supply.
2. Turn off the water tap.
3. Detach the drainage connection.
4. Detach the drinking water connection.
5. Loosen any screws fastening the appliance to cabinet parts.
6. Remove the base panel if fitted.
7. Pull the appliance out carefully, along with the hose behind it.

Protect appliance from frost

If there is a risk of frost where the appliance will be standing, e.g. in a holiday home, empty the appliance completely.

- ▶ Empty the appliance.
→ *"Transporting the appliance"*,
Page 61

Transporting the appliance

To avoid damage to the appliance, empty it before transporting.

Note: Always transport the dishwasher upright to prevent residual water getting into the machine's controls and damaging the appliance.

1. Remove tableware from the appliance.
2. Secure loose parts.
3. "Switch on the appliance."
→ Page 35
4. Select the programme with the highest temperature.
→ *"Programmes"*, Page 20
5. "Start the programme." → Page 36
6. To drain the appliance, terminate the programme after approx. 4 minutes.
→ *"Terminate programme"*,
Page 36
7. "Switch off the appliance."
→ Page 36
8. Turn off the water tap.
9. To empty the residual water out of the appliance, detach the supply hose and let the water drain out.

Disposing of old appliance

Valuable raw materials can be re-used by recycling.

WARNING

Risk of harm to health!

Children can lock themselves in the appliance, thereby putting their lives at risk.

- ▶ With redundant appliances, unplug the power cord. Then cut through the cord and damage the lock on the appliance door beyond repair so that the appliance door will no longer close.

1. Unplug the appliance from the mains.
2. Cut through the power cord.
3. Dispose of the appliance in an environmentally friendly manner.

Information about current disposal methods are available from your specialist dealer or local authority.



This appliance is labelled in accordance with European Directive 2012/19/EU concerning used electrical and electronic appliances (waste electrical and electronic equipment - WEEE). The guideline determines the framework for the return and recycling of used appliances as applicable throughout the EU.

Customer Service

If you have any queries, are unable to rectify faults on the appliance yourself or if your appliance needs to be repaired, contact Customer Service. Function-relevant genuine spare parts according to the corresponding Eco-design Order can be obtained from Customer Service for a period of at

least 10 years from the date on which your appliance was placed on the market within the European Economic Area.

Note: Under the terms of the manufacturer's warranty the use of Customer Service is free of charge.

Detailed information on the warranty period and terms of warranty in your country is available from our after-sales service, your retailer or on our website.

If you contact Customer Service, you will require the product number (E-Nr.), the production number (FD) and the consecutive numbering (Z-Nr.) of your appliance.

The contact details for Customer Service can be found in the enclosed Customer Service directory or on our website.

Product number (E-Nr.), production number (FD) and consecutive numbering (Z-Nr.)

You can find the product number (E-Nr.), the production number (FD) and the consecutive numbering (Z-Nr.) on the appliance's rating plate.

The rating plate is located inside the appliance door.

Make a note of your appliance's details and the Customer Service telephone number to find them again quickly.

AQUA-STOP guarantee

In addition to warranty claims against the seller under the purchase agreement and in addition to our manufacturer's warranty, we offer compensation under the following conditions.

- If our Aqua-Stop system is defective and causes water damage, we will make good the damage for private users. To ensure protection

from water damage, the appliance must be connected to the power supply.

- The liability guarantee is valid for the service life of the appliance.
- A claim can only be made under the guarantee if the appliance has been correctly installed and connected with Aqua-Stop according to our instructions; this also includes correctly fitting the Aqua-Stop extension (genuine accessory). Our guarantee does not cover defective supply lines or fittings up to the Aqua-Stop connection on the tap.
- If your appliance is fitted with Aqua-Stop, you can in principle leave your appliance unattended during operation and the tap turned on afterwards. The tap only needs to be turned off if you are away from home for a long period, e.g. on holiday for several weeks.

Technical specifications

| | |
|-------------------|---|
| Weight | Max.: 60 kg |
| Voltage | 220 - 240 V, 50 Hz or 60 Hz |
| Power rating | 2000 - 2400 W |
| Fuse | 10 - 16A |
| Water pressure | ■ min. 50 kPa (0.5 bar) ■ max. 1000 kPa (10 bar) |
| Inlet rate | Min. 10 l/min |
| Water temperature | Cold water. Hot water max.: 60 °C |
| Capacity | 14 place settings |

You can find more information about your model online at <https://eprel.ec.europa.eu/>¹. This web address is linked to the official EU EPREL product database. Please then follow the instructions on searching for the model. The model identifier is made up of the characters before the slash in the product number (E-Nr.) on the rating plate. Alternatively, you can also find the model identifier in the first line of the EU energy label.

Information regarding Free and Open Source Software

This product includes software components that are licensed by the copyright holders as free or open source software. The applicable licence information is stored on your home appliance. You can also access the applicable licence information via your Home Connect app: "Profile -> Legal information -> Licence Information".² You can download the licence information on the brand product website. (Please search on the product website for your appliance model and additional documents). Alternatively, you can request the relevant information from oss-request@bshg.com or BSH Hausgeräte GmbH, Carl-Wery-Str. 34, 81739 Munich, Germany. The source code will be made available to you on request. Please send your request to oss-request@bshg.com or BSH Hausgeräte GmbH, Carl-Wery-Str.34, 81739 Munich, Germany.

Subject: „OSSREQUEST“

The cost of performing your request will be charged to you. This offer is valid for three years from the date of purchase or at least as long as we offer support and spare parts for the relevant appliance.

Declaration of Conformity

BSH Hausgeräte GmbH hereby declares that the appliance with Home Connect functionality conforms to the basic requirements and other relevant provisions of Directive 2014/53/EU.

A detailed RED Declaration of Conformity can be found online at www.neff-international.com among the additional documents on the product page for your appliance.



Hereby, BSH Hausgeräte GmbH declares that the appliance with Home Connect functionality is in compliance with relevant statutory requirements.³

A detailed Declaration of Conformity can be found online at www.neff-home.com/uk among the additional documents on the product page for your appliance.³



Only applies to Great Britain
2.4 GHz band (2400–2483.5 MHz):
Max. 100 mW

¹ Only applies to countries in the European Economic Area

² Depending on the appliance specifications

³ Only applies to Great Britain

en Declaration of Conformity

5 GHz band (5150–5350 MHz +
5470–5725 MHz): Max. 100 mW

| | | | | | | | | | |
|--|----|----|----|----|----|---------|----|----|----|
|  | BE | BG | CZ | DK | DE | EE | IE | EL | ES |
| | FR | HR | IT | CY | LI | LV | LT | LU | HU |
| | MT | NL | AT | PL | PT | RO | SI | SK | FI |
| | SE | NO | CH | TR | IS | UK (NI) | | | |

5 GHz WLAN (Wi-Fi): For indoor use only.

| | | | | | | | |
|----|----|----|----|----|----|----|----|
| AL | BA | MD | ME | MK | RS | UK | UA |
|----|----|----|----|----|----|----|----|

5 GHz WLAN (Wi-Fi): For indoor use only.

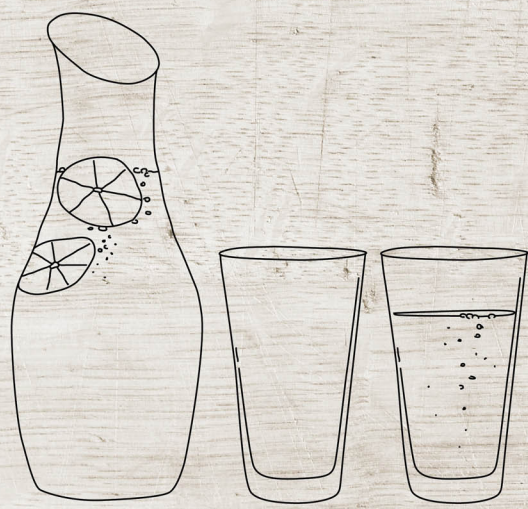

REGISTER YOUR PRODUCT
ONLINE NEFF-HOME.COM

BSH Hausgeräte GmbH
Carl-Wery-Straße 34
81739 München, GERMANY

Valid within Great Britain:
Imported to Great Britain by
BSH Home Appliances Ltd.
Grand Union House
Old Wolverton Road
Wolverton, Milton Keynes
MK12 5PT
United Kingdom



9001561489

en
020406
650 P5

