

**Fisher & Paykel**  
*innovative living*

**aerotech**  
ADVANCED COOKING SYSTEM

**Multifunction oven**  
**User guide US CA**

# Contents

Introduction	3
Safety & warnings	4
Location of features	6
Setting the clock	7
Oven displays	8
Oven modes	9
Shelf positions	12
Accessories	13
Using the oven controls	14
Automatic cooking	15
Oven operation	17
USER SELECT options	22
Cooking mode options	26
Cooking charts	27
Cleaning	34
SELF CLEAN mode	36
Troubleshooting	39
Maintenance	41
Limited warranty	42



# Introduction

Thank you for buying a Fisher & Paykel AeroTech® oven. Now that it is installed and ready to use, you will want to know everything about it to make sure you get excellent results right from the start. This guide introduces you to all its features, as well as giving you a comprehensive set of cooking charts. We recommend you read the whole guide before using your new oven, for both safety and cooking success.

For further information, go to [www.fisherpaykel.com](http://www.fisherpaykel.com)

To change the language in the oven mode displays to French/Spanish, go to 'How to change the language' in 'USER SELECT options'.

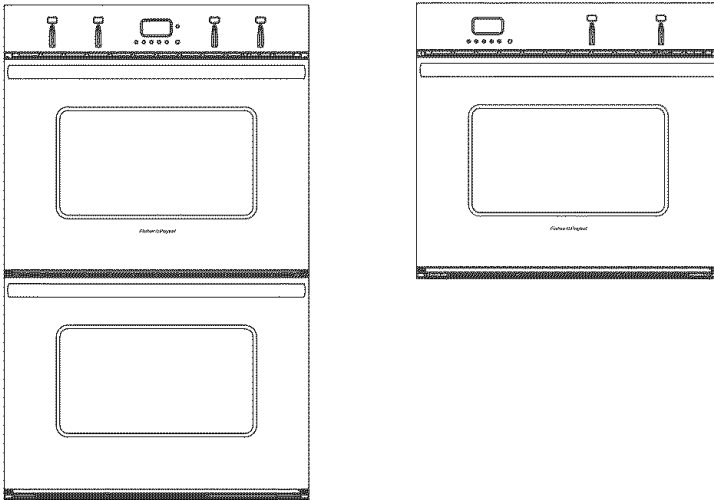

Fisher & Paykel AeroTech® oven  
Double model OD302 and single model OS302

**Important!**  
SAVE THESE INSTRUCTIONS

# Safety and warnings



This symbol alerts you to hazards such as fire, electrical shock, or other potential injuries. It also warns you of things that may cause damage to your oven.

## **⚠ WARNING!**



### **Hot Surface Hazard**

Accessible parts will become hot when in use.

Children should be kept away and care should be taken.

Failure to do so could result in burns and scalds.

## **⚠ WARNING!**

To reduce the risk of fire, electrical shock, injury to persons, or damage when using the oven, follow the 'Important safety precautions' listed below:

### Important safety precautions

- Read all the instructions before using the oven. Use the oven only for its intended purpose as described in these instructions.
- **Proper installation.** Be sure your appliance is properly installed and grounded by a qualified technician.
- **Never use your appliance for warming or heating the room.** Persons could be burned or injured or a fire could start.
- **Do not leave children alone.** Children should not be left alone or unattended in the area where the appliance is in use. They should never be allowed to sit or stand on any part of the appliance.
- **Wear proper apparel.** Do not wear loose fitting or hanging garments when using the appliance. They could ignite or melt if they touch an element or hot surface or you could be burned.
- **User servicing: Do not repair or replace any part of the appliance unless specifically recommended in the manual.** All other servicing should be referred to a qualified technician.
- **Storage in or on appliance: flammable materials should not be stored in an oven or near surface units.**
- **Do not use water on grease fires.** Smother fire or flame or use dry chemical or foam type extinguisher.
- **Use only dry oven mitts or potholders.** Moist or damp potholders on hot surfaces could result in burns from steam. Do not let potholders touch hot or heating elements. Do not use a towel or a bulky cloth for a potholder. It could catch fire.

- **Use care when opening the oven door.** Let hot air or steam escape before removing or replacing food.
- **Do not heat unopened food containers.** They can build up pressure that may cause the container to burst and result in injury.
- **Always keep oven vent ducts unobstructed.**
- **Placement of oven racks: always position oven racks (shelves) in the desired location while oven is cool.** If a rack must be removed while the oven is hot do not let the oven mitts or potholder contact hot heating elements in the oven or the base of the oven.
- **Do not clean the door seal (gasket) or cavity seal or use any oven cleaning products on them.** They are essential for a good seal. Care should be taken not to rub, damage or move the gaskets.
- **Do not use oven cleaners.** No commercial oven cleaner or oven liner protective coating of any kind should be used in or around any part of the oven.
- **Clean only the parts listed in the manual.**
- **Before self-cleaning the oven remove broiler pan and other utensils.**
- **Do not touch heating elements or interior surfaces of the oven.** Heating elements may be hot even though they are dark in color. Interior surfaces of an oven become hot enough to cause burns. During and after use, do not touch, or let clothing or other flammable materials contact heating elements or interior surfaces of the oven until they have had sufficient time to cool. Other surfaces of the appliance may become hot enough to cause burns - among these surfaces are the oven vent, the surface near the oven vent, and the oven door and window, could also become hot enough to cause burns.
- **The California Safe Drinking Water and Toxic Enforcement Act** requires businesses to warn customers of potential exposure to substances which are known by the State of California to cause cancer or reproductive harm. Small amounts of harmful chemicals are given off in the oven's self-cleaning cycle from insulation and food decomposition. Significant exposure to these substances can cause cancer and reproductive harm. Venting with a hood or open window, and wiping out excess food spills prior to self-cleaning the oven reduces exposure.
- **Do not use a steam cleaner to clean your oven.**
- **Do not store things children might want above the oven.** Children could be burned or injured while climbing on it.
- **Do not operate the oven if it is damaged or not working properly.**
- **Do not install or use a damaged appliance.** If you receive a damaged product, contact your dealer or installer immediately.
- **Anyone with a disability that may limit their ability to use the appliance** should have a competent person instruct them in its use. This person should be satisfied that they can then use the appliance without danger to themselves or their surroundings.
- **Use only cookware approved for oven use.** Follow the cookware manufacturer's instructions.

# Location of features

The diagram below shows you what features your oven has and where they are located (double oven model shown).

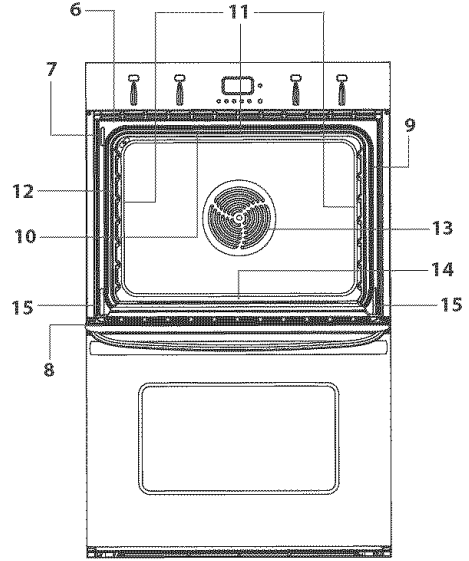
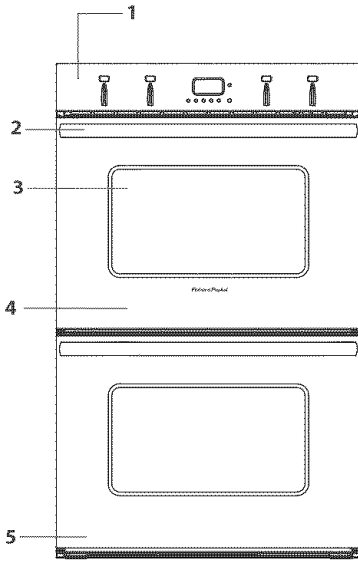

- 1 Control panel
- 2 Door handle
- 3 Oven window
- 4 Upper oven
- 5 Lower oven (double models only)

- 6 Model & serial number
- 7 Self-clean latch
- 8 Door seal
- 9 Cavity seal
- 10 Broil element
- 11 Oven lights
- 12 Cooking probe socket
- 13 Aero® fan & concealed element
- 14 Lower concealed element
- 15 Door hinge

# Setting the clock

As your oven is connected to a power supply for the first time, a tone will sound and the clock display will light up. The clock display will show '0:00' and the colon (:) will flash. Next, set the clock.

## Clock must be set before oven can be operated

### To set the clock

The oven clock has a default 24 hour display. '0:00' will be shown when the oven has been turned on at the wall and the colon will flash. Next, set the clock.

- 1 While the colon is flashing, rotate the setting selector until the correct time of day is showing.
- 2 Press the **CLOCK** button to adopt the time you have set or wait eight seconds and the setting will be automatically adopted.

Refer to the 'USER SELECT options' for instructions on how to change the clock to display 12 hour time.

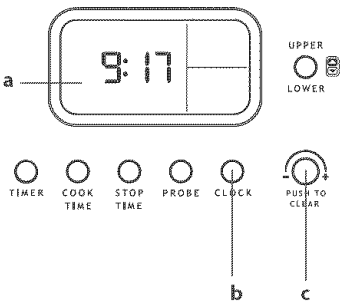

**a** Clock display

**b** **CLOCK** button

- allows you to set the clock.

**c** **PUSH TO CLEAR** 

- turn this button to set the: clock/timer/  
probe temperature/cook time/stop time.  
Press this button to clear the display.

# Oven displays

## Oven mode dial & display

Turn clockwise to select your desired oven mode. When the mode is set, the lights and cooling fan will come on.



## Temperature dial & display

Turn clockwise to select the oven temperature you want to cook at. The default setting for the temperature display is degrees Fahrenheit. Refer to the 'USER SELECT options' for instructions on how to change the temperature display settings.

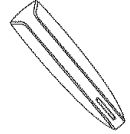
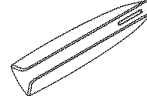

Note: for double oven models, controls on the left are for the upper cavity and controls on the right are for the lower cavity.

## Preheating your oven

- Preheat your oven when using the following modes: TRUEAERO, AEROBAKE, BAKE, AEROPASTRY and PASTRY BAKE. Preheating your oven is not required when using ROAST and AEROBROIL.
- Position shelves in the oven before preheating.
- When your oven is preheating, your selected cooking temperature is displayed alternately with the actual oven temperature. When the oven has reached the selected temperature an audible beep will sound and the temperature display will change from orange to green (brushed stainless steel models) or orange to blue (Iridium stainless steel models).
- The AeroTech® oven is equipped with a fast preheat function. In TRUEAERO, AEROBAKE, BAKE, AEROPASTRY and PASTRY BAKE modes it will heat to 345 °F (175 °C) from cold in under 10 minutes and to 425 °F (220 °C) in under 15 minutes.

Note: if you want to change the oven mode and/or temperature during operation, turn the oven mode and temperature dials to OFF then wait for the temperature and mode lights to turn off before selecting your new settings. This will reactivate the fast preheat function.

# Oven modes

Your Fisher & Paykel AeroTech® oven has nine cooking modes plus WARM and SELF CLEAN. These modes use different combinations of elements and the convection fan to give you maximum flexibility when cooking.



## **TRUEAERO:** convection fan plus fan element

TRUEAERO is a very flexible method of cooking. A concealed heating element surrounding the fan in the rear of the oven heats air, which is then blown into the cavity. The consistent temperature creates an ideal oven environment giving baking which is well risen and evenly coloured. Cookies are crisp on the outside and chewy in the middle, meat and poultry is deliciously browned and sizzling while remaining juicy and tender. Casseroles are cooked to perfection and reheating is quick and efficient. TRUEAERO is the mode to choose for multi-shelf cooking and complete oven meals.



## **AEROBAKE:** convection fan plus upper and lower elements

The oven fan circulates hot air from the top outer and lower concealed elements and distributes it around the oven cavity. Food cooked using the AEROBAKE mode tends to brown more quickly than foods cooked on conventional modes like BAKE. AEROBAKE is great for crisping pastry in lemon meringue pie and vegetable phyllo parcels. AEROBAKE at a low temperature – 125 °F (50 °C) – is ideal for drying fruit, vegetables and herbs.



## **BAKE:** upper and lower elements

Heat comes from the top outer and lower concealed elements. BAKE is the conventional cooking mode, suitable for single shelf cooking. It is ideal for foods that require long cooking periods or cooking at low temperatures, like meringues and rich fruitcakes.



## **AEROPAstry:** convection fan plus lower element

Heat from the lower concealed element is circulated throughout the oven cavity by the oven fan. Excellent for sweet and savory pastry foods, for moist breads and brownies and cookies that you want extra chewy.



## **PASTRY BAKE:** lower element

Heat comes from the lower element only. This is a traditional cooking mode which is suitable for recipes that were developed in older ovens. For best results, cook on only one shelf at a time. It is perfect for foods that require delicate cooking and have a pastry base, like custard tarts, quiches and cheesecake or anything that does not require direct heat and browning on the top surface.



### **WARM**

WARM is a constant low heat of 165 °F (75 °C). It is excellent for keeping cooked food hot and warming plates and serving dishes. To reheat food from cold, use TRUEAERO and change to WARM only when the food is piping hot, as this mode will not bring cold food up to a temperature high enough to kill any harmful bacteria.



### **ROAST**

ROAST is a two-step program that has been developed to help you cook delicious roasts effortlessly. Place the meat in the cold oven and the first stage will sear the meat at a high temperature for 20 minutes to crisp and brown the exterior. The oven then automatically drops to a lower, selected temperature for the remainder of the cooking time, giving you a moist and juicy roast. ROAST can be used with or without the cooking probe and is also great for cooking vegetables.



### **BROIL: upper inner element**

BROIL delivers intense heat from the inner region of the top element. Great when you need to quickly broil smaller dishes, for example Crème Brûlée, or one to two portions of your usual favorites, like crispy chicken breasts or a steak. Broil takes a minute or so to warm up and is carried out with the door closed. Power levels are expressed as a percentage from LO (50% power) to HI (100% power).



### **MAXIBROIL: upper inner and outer elements**

MAXIBROIL delivers intense heat from the entire top element. It is the most suitable mode for 'finishing off' many meals, for example browning the top of potato gratin and frittata as well as cooking smaller cuts of meat. Use MAXIBROIL to toast bread or as well as broiling your favorite chicken, fish and steak. MAXIBROIL takes a minute or so to warm up and is carried out with the door closed. Power levels are expressed as a percentage from LO (50% power) to HI (100% power).



### **AEROBROIL: fan plus upper inner and outer elements**

AEROBROIL produces food with a finish that is similar to a rotisserie. Meat, poultry and vegetables cook beautifully; food is crisp and brown on the outside while the inside remains moist and tender. Try using this mode with foods you might usually fry, like meatballs. It is great for chops, cutlets and beef burgers as well as vegetables.

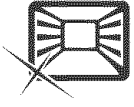

## SELF CLEAN

This oven features a pyrolytic self-cleaning cycle that takes care of the mess and grime that is traditionally associated with oven cleaning. During self-clean cycles the oven reaches higher temperatures than it does for cooking and this burns off and breaks down soil and grease deposits. A smoke eliminator and active venting system eradicates odor. The ash residue that remains can simply be removed from the cool oven with a damp cloth or sponge.

## The cooling fan

A cooling fan will come on automatically when most oven modes are used, and blow air out below the oven door. The cooling fan may continue to run after the oven is switched off to keep the door and control panel cool.

# Shelf positions

## Optilevel™

The Optilevel™ shelving system allows you to choose the optimum cooking level within the oven. Placing the shelves on or between the shelf support runners provides 13 cooking positions to choose from.

Organize the shelves prior to heating the oven. Generally, the shelf positions located in the top of the oven are suitable for broiling. Shelves in the middle and lower region of the oven are suitable for baking, roasting and casseroles. For more specific information on which shelf position to use, refer to the 'Cooking charts'.

Your oven shelves come with built-in stop locks for your safety. This means when inserted properly they will not tilt when pulled towards you.

### To insert shelves

Position the shelves so that the single  in the center is facing towards you, as shown, and slide the shelf right to the back of the oven. Shelves will feel very stable when inserted correctly.

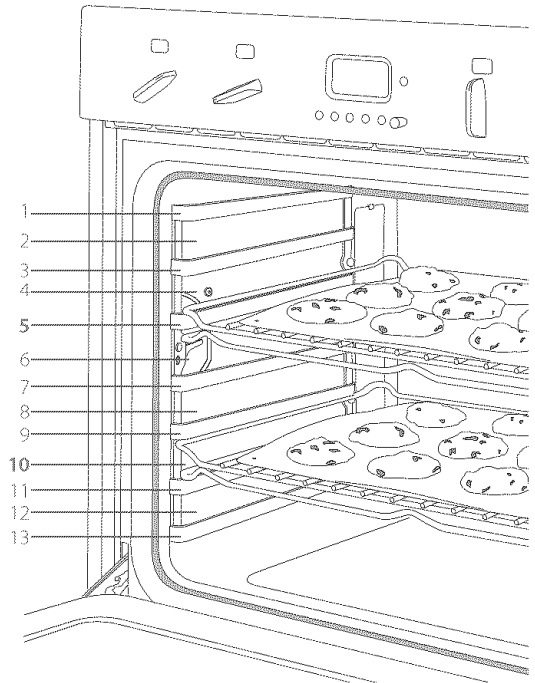

Shelf positions with shelves at positions 5 and 10

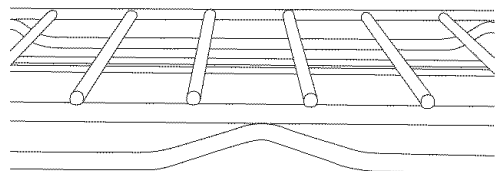

Shelf detail showing the single  facing toward you

# Accessories

## Three-piece broil/roast system

- The three-piece broil/roast system (made up of the pan, grid and rack) is designed to prevent hot fat and juices in the broil pan splattering throughout the oven.
- All pieces can be used together as one complete unit, or in different combinations.

## Glass tray (not supplied with all models)

- This is made of extremely tough glass and is perfect oven-to-tableware.
- The glass tray is great for all broiling and baking modes.
- Wash in hot soapy water or the dishwasher. Soaking with a little dishwasher detergent will help to remove stubborn stains.

## Cookie sheets

- The cookie sheets have a non-stick finish and need only a light coating of cooking spray or greasing before use.
- Their dark color absorbs heat and you may find that your favorite recipes cook more quickly than on old shiny trays. Alternatively, you can reduce the oven temperature by approximately 60-70 °F (15-20 °C).
- Allow your baking to cool for a few minutes after it comes out of the oven before removing it from the tray using a wooden or Teflon spatula.
- Always remove food before it is completely cold. In most cases wiping with a paper towel is all that is needed to clean the trays.

## Pizza stone and paddle (not supplied with all models)

- Your pizza stone will allow you to cook a pizza like one cooked in an authentic pizza oven.
- Using the pizza stone is a great way to cook bought, ready-made pizzas as well as home-made ones.
- If cooking frozen pizza, allow it to defrost completely before placing on the hot pizza stone.

# Using the oven controls

In double ovens controls on the left are for the upper oven and controls on the right are for the lower oven. Pushing the oven cavity selector button lets you toggle between the oven cavities, for example if you are setting automatic programs.



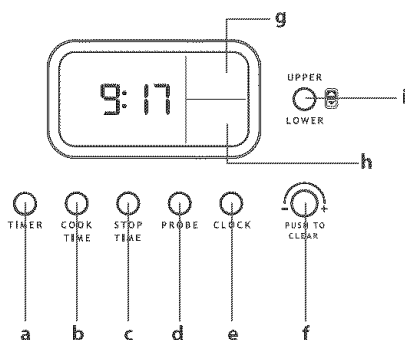

- a **TIMER** button
  - b **COOK TIME** button
  - c **STOP TIME** button
  - d **PROBE** button
  - e **CLOCK** button
  - f **PUSH TO CLEAR**  button (rotate/press)
  - g Upper oven cavity display
  - h Lower oven cavity display
  - i Oven cavity selector button - press this button to toggle between upper and lower cavity settings
- g, h, and i are on double models only



## Timer

The timer can be used at any time, even when the oven is not in use.

### To set the timer

- 1 Press the **TIMER** button. The **TIMER** symbol and the colon will flash in the clock display.
- 2 Rotate the **PUSH TO CLEAR**  button until you have the time you need. Press the **TIMER** button or wait eight seconds for the setting to be adopted and the timer will begin to count down.
- 3 To cancel the timer, press the **TIMER** button then the **PUSH TO CLEAR**  button.
- 4 When the set time finishes the **TIMER** symbol and  will flash and the oven will beep. Press the **TIMER** or **PUSH TO CLEAR**  button to stop the beeping and clear the timer.



**The timer does not turn the oven off.**

# Automatic cooking

## Automatic time cooking

Automatic time (delayed start) cooking will turn the oven on and off at times you have set.

To set automatic time cooking:

- 1 Check that the clock shows the correct time.
- 2 In double ovens, choose the upper or lower oven. This is important.
- 3 Select the oven mode and temperature.
- 4 Decide how long the food will take to cook, allowing time for preheating if necessary.
- 5 Press the **COOK TIME** button and rotate the **PUSH TO CLEAR**  button to select this length of time. You do not need to set a start time.
- 6 Press the **STOP TIME** button, and rotate the **PUSH TO CLEAR**  button to select the time of day you want the oven to stop cooking.

Note: you must set this stop time within eight seconds, or the cook time settings will be automatically adopted. To cancel the cook time settings, turn the oven mode and temperature dials to OFF, as described in 'Cancelling automatic cooking'.

- The oven mode and temperature dials will still function (as during manual operation). You can alter these before or during cooking, and you can manually turn the oven off before the set cook time has finished.
- Before cooking starts, **DELAY, AUTO** and the current time will show in the clock display. The oven mode and temperature displays will dim, and the oven light will be off.
- During cooking, **AUTO, COOK TIME** and the remaining cook time will show in the clock display. The oven mode and temperature displays will be bright, and the oven light will be on.
- When cooking has finished, the oven will beep and turn off. The temperature and oven displays will dim, and the oven light will go off. **COOK TIME** and **AUTO** will flash in the clock display.
- Turn the oven mode and temperature dials to OFF. The oven light will stay on for eight seconds, and then go off when the oven returns to manual mode.

## Automatic stop cooking

You can set the oven to automatic stop cooking at any time during cooking, or when you turn the oven on.

To set automatic stop cooking:

- 1 Check that the clock shows the correct time.
- 2 In double ovens, choose the upper or lower oven. This is important.
- 3 Select the oven mode and temperature.
- 4 Press the **STOP TIME** button, and rotate the **PUSH TO CLEAR**  button to select the time you want the oven to stop cooking.

- During cooking, **AUTO**, **COOK TIME** and the remaining cook time will show in the clock display. The oven mode and temperature displays will be bright, and the oven light will be on.
- When the cook time is finished, the oven will beep and turn off. The oven and temperature displays will dim, and the oven light will go off. **COOK TIME** and **AUTO** will flash in the clock display.
- Turn the oven mode and temperature to OFF. The oven light will stay on for eight seconds, and then go off when the oven returns to manual mode.

### **Cancelling automatic cooking**

To cancel automatic time and automatic stop cooking, turn the oven mode and temperature dials to OFF. After eight seconds, the clock display will revert to the time of day, and the oven will return to manual mode.

## **⚠ WARNING!**

**Food safety is an important consideration when using delayed cooking modes.**

**To avoid potential spoiling of food and sickness, take the following steps:**

- Avoid using foods that will spoil while waiting for the cooking cycle to begin. Typical food to avoid include those containing eggs and dairy products, cream soups, cooked and uncooked meats, poultry and fish.
- If cooking will not begin immediately, place only very cold or frozen food in the oven. Most unfrozen food should never stand in the oven for more than two hours before cooking begins.
- Do not allow food to remain in the oven for more than one hour after completion of the cooking cycle.

# Oven operation

## Cooking probe

Use your cooking probe to accurately judge when your meat is perfectly cooked. The probe can be used on TRUEAERO, AEROBAKE, ROAST, AEROBROIL and BAKE modes.

### Using the cooking probe

- 1 Select the oven mode and temperature and preheat the oven if appropriate. ROAST does not require preheating.
- 2 Insert as much of the metal cooking probe as possible horizontally into the thickest part of the fully defrosted meat. The thicker the meat, the longer it will take to cook, so it is important that the probe is measuring the temperature of the meat at its thickest point. Make sure the probe does not touch bone, fat or gristle, as this will give you a false reading.
- 3 Place the meat on the three-piece broil/roast system.
- 4 When the oven has preheated (if required) to the set temperature place the broil/roast system in the oven and insert the plug end of the cooking probe into the probe socket, using an oven mitt if the oven is hot. The probe socket is on the left hand side of the oven, halfway down between shelf positions three and five. Make sure the probe is pushed into the socket, then close the oven door.
- 5 Select the upper or lower cavity for double oven models using the oven cavity selector button.
- 6 Press the **PROBE** button on the control panel. The pre-set temperature of 150 °F (65 °C) and PROBE will light up in the display. If you want to select a different internal food temperature from the preset temperature, rotate the **PUSH TO CLEAR**  button while the **PROBE** symbol is flashing. For temperature guidelines, see 'Cooking charts'.

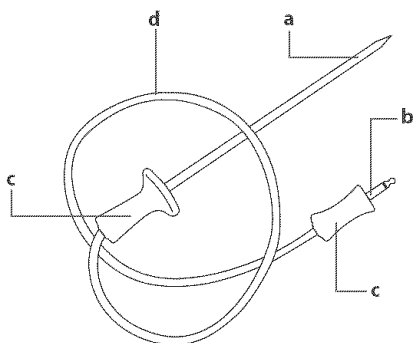

- |               |          |
|---------------|----------|
| a Metal probe | c Handle |
| b Plug        | d Cable  |

### To cancel the cooking probe

To cancel the probe setting before the set temperature has been reached press the **PROBE** button then the **PUSH TO CLEAR**  button.

### Tips for using the cooking probe

- The display will show the actual internal temperature. To look at the set internal temperature press **PROBE**.
- The oven will beep and automatically turn off when the set internal temperature has been reached. The temperature and oven mode displays will remain on and the oven light will go out.
- Return the oven to manual mode by pressing the **PUSH TO CLEAR**  button. Turn the oven mode dial and temperature dials to OFF.

- The cooking probe can be used with automatic cooking functions. If the probe reaches the set temperature before the stop time is reached the probe will turn the oven off.
- The internal temperature of the meat will continue to rise by 5-15 °F (2-8 °C) after you have removed it from the oven so allow for this in your calculations.

## Important!

- Use only the cooking probe supplied with your AeroTech® oven.
- Hold the cooking probe at the 'handles' when inserting and removing it from food and the cooking probe socket.
- Remember to remove the cooking probe from the oven before you start a self-clean cycle.
- Do not store the probe in the oven.
- Only use the probe with food that is fully defrosted.

## Roasting

ROAST is a two-step program. It has an initial 20 minute searing stage to brown the roast and caramelize the meat juices, then a reduction to your set temperature for the remainder of the cooking period, producing a tender and juicy roast that is full of flavor. Little browning takes place after the initial 20 minute searing.

### Using the ROAST mode



- 1 Place the meat on the three-piece broil/roast system on a shelf so that the top of the roast is in the center of the oven or lower.
  - 2 Select ROAST using the oven mode dial. Select the temperature. When using the ROAST mode, there is no need to preheat the oven.
- Use automatic/delayed start cooking if you want your oven to automatically turn on/off. For suggested roasting times and temperatures see 'Cooking charts'.

### Tips for a successful roast

- The initial searing is too hot for 'roasting bags'. Use TRUEAERO, AEROBAKE or BAKE if you are using roasting or oven bags and follow the manufacturer's guidelines.
- Tender cuts should be cooked at a high temperature quickly, while tougher cuts require a lower temperature for a longer time.
- For perfect results use the meat probe to take out the guesswork.
- Placing the meat on the wire broil/roast rack allows hot air to circulate around it and gives more even browning.
- Thick pieces of meat take longer to cook than thin pieces of the same weight. Meat cooks by absorbing heat from the outer surface to the middle. The thicker the meat the longer it will take to cook.
- Roasts containing bones cook more quickly than boneless or rolled roasts due to the bone conducting heat throughout the meat. Stuffed roasts will take longer to cook.

- Selecting the cooking time for your roast depends on your personal preference. Meat taken straight from the refrigerator will take longer to cook.
- Poultry should always be well cooked with the juices running clear.
- Roasting is a method of cooking meat that uses dry heat. Don't add water to your roast as this has a steaming effect.
- Vegetables are excellent cooked on ROAST. Clean and cut them into large chunks, coat lightly with oil, season and place in a single layer on the greased glass tray. Select ROAST using the oven mode dial and 340 °F (175 °C). Place in the oven on a shelf in position eight. Cook for 35 – 45 minutes, depending on size and type of vegetable, until golden brown and tender. Vegetables can be placed on the broiling system, around meat if they are going to take approximately the same length of time to cook. Longer than about two hours will overcook the vegetables so put them in the oven partway through cooking a large piece of meat. The vegetables will brown more slowly if they have missed the initial searing stage of the ROAST mode so allow plenty of time to cook them thoroughly, up to two hours at 320-340 °F (150-175 °C).

## Broiling

Your AeroTech® oven gives you a choice of BROIL , MAXIBROIL  and AEROBROIL . For many meats broiling is considered to be a healthier alternative to frying. Broiling is a relatively quick method of cooking foods producing superior flavor and is also a great way to cook vegetables. Carry out all broiling with the oven door completely closed.

When using AEROBROIL the upper elements are on and the hot air is circulated around the oven by the oven fan. AEROBROIL is suitable for foods that you might normally pan fry, barbecue or rotisserie, for larger cuts of meat and whole chickens.

## **WARNING!**



### **Hot Surface Hazard**

Hot steam may be produced when using BROIL, MAXIBROIL, or AEROBROIL modes.

Take care when opening the oven door and always use oven mitts or pot holders to handle hot cooking utensils.

Failure to do so could result in burns or scalds.

### Using the broil modes

- 1 Place food on top of the broil/roast pan, grid and rack.
- 2 Select the shelf position you want to broil at - see 'Cooking charts' for suggested shelf positions, times and temperatures.

## Tips for successful broiling

- Position the oven shelves before you turn the oven on.
- To make cleaning the broil/roast system easier, spray the rack, grid and inside of the pan with a light coating of non-stick cooking spray before use.
- For best results allow the broil element to warm up for a minute or two before putting food in the oven.
- Use the timer to time the broiling process if desired.
- Keep the oven door closed.
- We recommend using the three-piece broil/roast system provided with your AeroTech® oven. This has been specifically designed to reduce splatter and smoke. If you do use other glass or ceramic dishes and pans, be sure that they can withstand the high temperature of the broil.
- Basting lean meat, fish or chicken with a marinade or juices while broiling will add flavour and moisture.
- If turning meat halfway through the cooking time, use tongs or a spatula. Avoid piercing meat with a knife or fork as this will allow juices to escape, making the meat less moist.



## Tips for successful baking

- When baking, make sure the cake tins do not touch each other or the sides of the oven. Stagger tins across shelves if necessary and use TRUEAERO  for multi-shelf cooking. Do not open the oven door until at least  $\frac{3}{4}$  through the suggested cooking time.
- Baking pans that are made of dark, dull metals are recommended in appliances with a concealed lower element like the AeroTech® oven. They absorb heat and often cook and brown food faster than reflective, shiny aluminum pans and sheets.

## Important!

Do not place aluminum foil, dishes with reflective qualities or any object on the oven floor as this will cause a heat build-up which will result in irreversible damage to the porcelain enamel.

## Multi-shelf cooking

Multi-shelf cooking is very successful using the TRUEAERO mode. The AeroTech® advanced cooking system allows you to bake several different foods simultaneously on different levels giving you increased flexibility - as well as saving time. TRUEAERO is well suited to batch baking of cookies, biscuits, and muffins as well as complete oven meals. See 'Cooking charts' for suggested times, temperatures and shelf positions for multi-shelf cooking.

## Dehydrating, and proofing bread

### Tips for dehydrating

- To obtain a high quality dried product, select only unblemished, mature fruit.
- Wash fruit thoroughly and pat dry. Peel if desired. Unpeeled fruit will take longer to dry. Remove stones, stems or pips if necessary. Place fruit on a baking tray on a shelf in the oven.
- We recommend using TRUEAERO or AEROBAKE at 125 °F (50 °C).

### Tips for proofing bread

Your AeroTech® oven provides an ideal sealed environment to proof bread.

- Preheat the oven on BAKE at 80 °F (30 °C). When you are ready to proof the dough, turn the temperature and mode to off and place the dough in a covered bowl on a shelf in the warm oven. It will be the perfect temperature to proof dough and the AeroTech® oven is so well insulated that it will stay warm for several hours.

Note: Some recipes recommend putting water or ice in the oven with the bread dough during baking. The additional moisture improves the bread crust.

You must place the water or ice in a dish and on an oven shelf in positions 12 or 13. Do not put it directly onto the oven floor. Placing water, ice or any dish or tray directly on the oven floor irreversibly damages the porcelain enamel.

# USER SELECT options

## USER SELECT mode

USER SELECT mode allows you to configure some of the settings displayed on your AeroTech® oven control panel.

### How to enter USER SELECT mode

- 1 Be sure that the oven mode and temperature dials are off, that no automatic/delayed start programs are operating and that the clock is displaying the correct time of day.
- 2 Press the **TIMER** then the **CLOCK** button and hold down together until the oven 'beeps' (about two seconds). The oven mode display will show **USER SELECT**.



Oven mode display

## Sabbath mode

This mode is designed for religious faiths that observe a 'no work' requirement on the Sabbath.

### When your oven is in Sabbath mode

- Clock, temperature and oven mode displays will be disabled.
- No tones will sound.
- No error messages or temperature changes will be displayed. However, temperature can be adjusted.
- The cavity lights are on if the door is open when Sabbath mode is set. The cavity lights are off if the door is closed when Sabbath mode is set.

### How to set Sabbath mode

- 1 Enter the USER SELECT mode and turn the oven mode dial clockwise until the display shows **SAB MODE**.
- 2 Select the length of time you wish to stay in **SAB MODE** by rotating the **PUSH TO CLEAR** button. The maximum is 99 hours, in one hour steps, and is shown in the clock display. Select a temperature. **BAKE** is the only oven mode available in Sabbath mode.
- 3 To start Sabbath mode, press the **PUSH TO CLEAR** button. The oven mode display will show **SAB MODE** with no backlight. The temperature display will show **- - -**; temperatures can be adjusted but the display will not change.



Oven mode display

## Tips for using Sabbath mode

- In double oven models, different temperatures can be selected for upper and lower ovens by using their temperature dials. The oven mode dial for the lower oven must be turned to a function to activate the lower oven.
- The oven can be turned off at any time during Sabbath mode by turning the oven mode and temperature dials to OFF, but the oven will not revert to regular operation until the set time has elapsed.
- When the set time has elapsed the oven will revert to regular operation.
- You can exit Sabbath mode at any time by pressing the **PUSH TO CLEAR**  button and holding it down for five seconds.

## How to change the temperature scale

- 1 Enter the USER SELECT mode and turn the oven mode dial clockwise until **TEMP SCALE** appears in the display.
- 2 Press **PUSH TO CLEAR**  to select either 'C' or 'F' in the clock display. Selecting 'C' will convert the numbers shown in the temperature display to degrees Celsius while selecting 'F' will show the oven temperatures in degrees Fahrenheit.
- 3 Press the **CLOCK** button to activate.

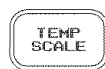

Oven mode display

## SHORT ALERT

By default, SHORT ALERT is off and the audible beep will sound continuously at the end of automatic cooking functions until cancelled by pressing the **PUSH TO CLEAR**  button.

### When SHORT ALERT is on

- An audible beep will sound five times at the end of automatic cooking functions and when the timer finishes. After five beeps, the alert will stop, then repeat every five minutes until cancelled by pressing the **PUSH TO CLEAR**  button.
- The clock display will flash continuously until cancelled.

## How to activate SHORT ALERT

- 1 Enter the USER SELECT mode and turn the oven mode dial clockwise until **SHORT ALERT** appears in the display.
- 2 Press **PUSH TO CLEAR**  to select either ON or OFF in the clock display.
- 3 Press the **CLOCK** button to activate.



Oven mode display

## How to change from 24 hour to 12 hour time display

- 1 Enter the USER SELECT mode and turn the oven mode dial clockwise until **TIME MODE** appears in the display.
- 2 Press **PUSH TO CLEAR**  to select either '24H' or '12H' in the clock display.
- 3 Press the **CLOCK** button to activate.



Oven mode display

## How to hide the time in the clock display

- 1 Enter the USER SELECT mode and turn the oven mode dial clockwise until **SHOW CLOCK** appears in the display.
- 2 Press **PUSH TO CLEAR**  to select either 'ON' or 'OFF' in the clock display.
- 3 Selecting 'ON' will show the time and 'OFF' will hide the time in the clock display. All other functions, such as **TIMER**, will continue to be shown as normal in the clock display when the time is hidden.
- 4 Press the **CLOCK** button to activate.



Oven mode display

## How to change the language

- 1 Enter the USER SELECT mode and turn the oven mode dial clockwise until **LANG USA** appears in the display.
- 2 Press **PUSH TO CLEAR**  to toggle through the different languages: US for American English, EN for UK English, FR for Canadian French or ES for South American Spanish.
- 3 Press the **CLOCK** button to activate.



Oven mode display

## How to reset the oven

This will reset TEMP, SCALE, SHORT ALERT, TIME MODE and SHOW CLOCK to their default settings. Sabbath mode and language settings will remain unaffected.

- 1 Enter the USER SELECT mode and turn the oven mode dial clockwise until **RESET** appears in the display.
- 2 Press **PUSH TO CLEAR**  to reset the oven to default settings.
- 3 Press the **CLOCK** button to exit USER SELECT mode.



Oven mode display

## Control panel lock

Locking the control panel disables all the buttons and dials which can be useful when cleaning oven surfaces or preventing accidental bumps and unauthorised use. The control panel can only be locked when the oven mode and temperature are OFF.

### To lock the control panel

Press the **PUSH TO CLEAR**  button and hold down for five seconds. The **LOCK** symbol will appear in the clock display. Repeat to unlock.

# Cooking mode options

This chart will help you to match your cooking requirements to the most appropriate cooking mode. Note: ● Recommended method ○ Alternative method.

	TRUEAERO	AEROBAKE	BAKE	AEROPAstry	PASTRY BAKE	ROAST	BROIL	MAXIBROIL	AEROBROIL
<b>Baked products</b>									
Cookies - single tray	○	●	○	○	○				
Cookies - multi tray	●								
Chewy choc. chip cookies	●	○	○	○	○				
Slices/Squares	○	○	○	●	○				
Chocolate cake	○	○	●						
Fruit cake	○	○	●						
Sponge	○	○	●						
Muffins - single tray	○	●	○						
Muffins - multi tray	●								
Meringue	●	○	○						
Bread/Rolls	●	○	○	○					
<b>Pastry</b>									
Apple pie	○	●	○						
Quiche	○	○	○	●	○				
Custard tart	○	○	○	○	●				
Phyllo/Flaky/Puff/Choux	○	●	○	○	○				
<b>Meat, fish and poultry</b>									
Roast beef/pork/lamb	○	○	○			●			○
Roast chicken - whole	○	●	○			○			●
Roast chicken - pieces	○	●	○				○	○	○
Roast turkey	●		○						
Steak/Chops/Cutlets		○					○	●	○
Fish	○	○	○				○	○	●
<b>Family favorites</b>									
Pizza	○	○	○	●	○				
Casserole	●	○	○		○				
Lasagne	○	●	○						○
Meatloaf	○	○	●						
Complete oven meals	●								
Vegetables - roasted	○	○	○			●			○
Vegetables - baked	○	○	●						
Vegetables - broiled							○	●	○

# Cooking charts

 TRUEAERO	Time (min)	Temp °F	Temp °C	Shelf (single/ multi)
<b>Baked products</b>				
Cookies	13-18	350-360	175-180	8; 5 & 10
Chewy chocolate chip cookies	15-20	340-360	170-180	8; 5 & 10
Vanilla cake	30-40	340-350	170-175	12
Squares/Slices	25-30	340-360	170-180	8
Shortbread	22-30	300-310	150-155	8
Cake - butter/choc	45-55	340-350	170-175	12
Cake - fruit rich	4-5 hrs	280-300	140-150	13
Cake - fruit light	85-95	310-330	155-165	13
Muffins	10-15	390-410	200-210	8; 5 & 10
Meringues	50-60	250-270	120-130	11
Biscuits	12-15	400-425	200-220	8; 5 & 10
Bread/Rolls	25-35	380-400	195-210	8
Pizza	10-15	440-450	225-230	10
Apple pie	35-45	350-360	175-180	10
<b>Pastry</b>				
Phyllo	15-25	375-390	190-200	8
Flaky/Puff	25-35	375-390	190-200	10
Quiche	20-30	350-375	175-190	10
Meat pie	40-50	350-375	180-190	10
Lemon meringue pie	20-30	370-375	185-190	10
Choux pastry	35-40	390-400	200-210	10
Custard tart - pastry	14-16	375-390	190-200	11
- filling	7	350-360	175-180	11
- filling cont.	20-30	310-330	155-165	11
<b>Family Favorites</b>				
Lasagne	30-40	350-375	175-190	10
Meatloaf	80-90	350-375	175-190	8
Chicken pieces	50-60	350-375	175-190	10
Casserole	55-70	340-375	170-190	10
<b>Vegetables</b>				
Baked	30-50	350-375	175-190	10
Roasted	30-45	375-390	190-200	9

**Baked products**

Cookies	8-12	340-350	170-175	9
Chewy chocolate chip cookies	12-18	320-330	160-165	8
Vanilla cake	30-35	340-350	170-175	11
Squares/slices	20-25	350-360	175-180	10
Shortbread	25-35	280-300	140-150	11
Cake - butter/choc	50-60	320-350	160-175	11
Cake - fruit rich	2-6 hrs	260-300	125-150	13
Cake - fruit light	2-2½ hrs	270-300	130-150	13
Sponge	20-25	320-350	160-175	8
Muffins	10-15	390-425	200-220	7
Meringues	60-70	200-225	100-110	11
Biscuits	10-12	390-425	200-220	8
Bread/rolls	15-30	390-425	200-220	8
Pizza	12-16	380-400	195-200	12
Apple pie	25-30	375-400	190-200	11

**Pastry**

Phyllo	15-25	375-390	190-200	9
Flaky/puff	20-30	370-390	185-200	9
Quiche	20-25	350-390	175-200	11
Meat pie	30-40	375-380	190-195	11
Lemon meringue pie	30-40	350-360	175-180	10
Choux pastry	30-35	390-400	200-210	11
Custard tart - pastry	12-15	375-390	190-200	8
- filling	7-9	350-360	175-180	8
- filling cont.	20-25	280-300	140-150	8

**Family favorites**

Lasagne	40-50	350-360	175-180	8
Meatloaf	55-65	350-360	175-180	8
Chicken pieces	30-40	350-375	175-190	10
Casserole	50-60	350-375	175-190	11

**Vegetables**

Baked	30-50	350-375	175-190	10
Roasted	30-45	375-390	190-200	9

**BAKE**

Time (min)

Temp °F

Temp °C

Shelf

**Baked products**

Cookies	8-12	350-370	175-185	9
Chewy chocolate chip cookies	12-18	330-350	165-175	9
Vanilla cake	30-35	330-350	165-175	9
Squares/slices	20-30	350-375	175-190	8
Shortbread	25-35	300-320	150-160	11
Cake - butter/choc	50-60	320-360	160-180	11
Cake - fruit rich	4-6 hrs	275-300	135-150	13
Cake - fruit light	2-2½ hrs	300-320	150-160	13
Sponge	20-40	340-375	170-190	9
Muffins	10-15	390-440	200-225	8
Meringues	60-70	250-270	120-130	11
Biscuits	10-12	410-425	210-220	7
Bread/rolls	15-30	390-425	200-220	8
Pizza	12-18	390-410	200-210	12
Apple pie	25-35	390-410	200-210	11

**Pastry**

Phyllo	20-30	375-390	190-200	8
Flaky/puff	20-30	400-410	200-210	8
Quiche	20-30	350-390	175-200	10
Meat pie	30-40	350-390	175-200	10
Lemon meringue pie	35-40	350-375	175-200	10
Choux pastry	35-45	390-410	175-190	8
Custard tart - pastry	12-15	375-390	200-210	8
- filling	7-9	350-360	175-180	8
- filling cont.	20-25	280-300	140-150	8

**Family favorites**

Lasagne	40-50	350-375	175-190	9
Meatloaf	55-65	350-360	175-180	9
Chicken pieces	30-40	350-375	175-190	9
Casserole	70-90	350-360	175-180	10

**Vegetables**

Baked	40-50	350-375	175-190	8
Roasted	35-50	375-390	190-200	8



## AEROPAstry

Time (min)

Temp °F

Temp °C

Shelf

### Baked products

Cookies	8-10	340-350	170-175	9
Oat cookies	12-15	320-330	160-165	9
Squares/slices	15-20	320-350	160-175	11
Shortbread	20-25	270-280	130-140	9
Pizza	15-20	440-475	225-250	10

### Pastry

Quiche	20-30	390-425	200-220	8
Meat pie	30-40	360-375	180-190	8
Lemon meringue pie	15-20	340-360	170-180	8



## PASTRY BAKE

Time (min)

Temp °F

Temp °C

Shelf

### Baked products

Sugar cookies	9-11	340-350	170-175	9
Oat cookies	10-15	320-330	160-165	9
Squares/slices	15-20	320-350	160-175	11
Shortbread	20-25	280-300	140-150	9

### Pastry

Quiche	20-30	390-425	200-220	8
Meat pie	30-40	360-375	180-190	8
Lemon meringue pie	15-20	340-360	170-180	8



## MAXIBROIL & BROIL

Time (min)

Broil setting

Shelf

### Beef

Steaks - rare	8-10	Hi	3
Steaks - medium	10-15	Hi	4
Minced - burgers	12-15	Hi	4
Minced - meatballs	12-15	Hi	4

### Lamb

Chops - medium	15-20	Hi	3
Chops - well done	20-25	Hi	3

### Pork

Chops - well done	15-20	Hi	3
Ham steak	15-20	Hi	4
Bacon	4-7	Hi	3

### Chicken

Boneless pieces	15-30	Hi	6
-----------------	-------	----	---

### Sausages

Sausages	10-15	Hi	4
----------	-------	----	---

### Fish

Fillets	8-12	Hi	4
Whole	15-20	Hi	4

**AEROBROIL**

	Time (min)	Temp °F	Temp °C	Shelf
<b>Beef</b>				
Ground - burgers	15-20	425-440	220-225	4
Ground - meatballs	10-15	375-410	190-210	4
<b>Lamb</b>				
Chops - medium	15-20	400-440	200-225	4
Chops - well done	20-25	400-440	200-225	4
Rack - medium	20-30	400-410	200-210	5
<b>Pork</b>				
Chops - well done	20-25	375-410	190-210	4
Ham steak	15-20	425-400	220-225	4
Bacon	10-15	425-440	220-225	3
<b>Chicken</b>				
Whole	30-35 per 1 lb/450 g	340-360	170-180	9
Boneless pieces	30-50	350-375	175-190	7
<b>Sausages</b>				
Sausages	10-15	375-400	190-200	4
<b>Fish</b>				
Fillets	8-12	400-425	200-220	4
Whole	15-20	400-425	200-220	4

## Roasting meat

We recommend you use the cooking probe to accurately judge when meat is cooked to your preference. 'Time per pound/450g' is a rough guide and should only be used to estimate when the meat will be ready. Cooking with ROAST, TRUEAERO, AEROBAKE, and AEROGRILL will take less time than with BAKE.

	Time (min per lb/450g)	Oven Temp °F	Oven Temp °C	Probe Temp °F	Probe Temp °C	Shelf	Best Mode
<b>Beef</b>							
Boneless roast - rare	18-32	320-340	160-170	130-140	54-60	10	ROAST
Boneless roast - medium	25-40	320-340	160-170	150-160	65-70	10	ROAST
Boneless roast - well done	30-55	320-340	160-170	165-175	74-79	10	ROAST
Prime or standing rib roast - rare	15-30	320-340	160-170	130-140	54-60	10	ROAST
Prime or standing rib roast - medium	20-35	320-340	160-170	150-160	65-70	10	ROAST
Prime or standing rib roast - well done	25-40	320-340	160-170	165-175	74-79	10	ROAST
<b>Leg of lamb</b>							
With bone - medium	18-28	320-340	160-170	150-160	65-70	10	ROAST
With bone - well done	20-33	320-340	160-170	165-175	74-79	10	ROAST
Boneless - medium	20-35	320-340	160-170	150-160	65-70	10	ROAST
Boneless - well done	25-45	320-340	160-170	170-175	77-79	10	ROAST
<b>Veal</b>							
Medium	20-43	320-340	160-170	150-160	65-70	10	ROAST
Well done	25-45	320-340	160-170	170-175	77-79	10	ROAST
<b>Chicken</b>							
Whole	15-20	350-375	175-190	180	82	11	TRUEAERO
<b>Turkey</b>							
With stuffing - well done	17-22	330-350	165-175	180	82	13	TRUEAERO
Well done	15-20	300-330	150-165	180	82	13	TRUEAERO
<b>Pork</b>							
Boneless roast - medium	25-40	340-350	170-175	145-155	63-68	10	AEROBAKE
Boneless roast - well done	30-45	340-350	170-175	165-175	74-79	10	AEROBAKE
<b>Venison*</b>							
Rare	7½ per inch of thickness	440	225	120-130	49-54	8	AEROBAKE
Medium rare	9 per inch of thickness	440	225	130-140	54-60	8	AEROBAKE

\*Brown prior to roasting on an oiled skillet or frying pan on high heat. The internal temperature of venison rises more on standing due to the high cooking temperature, therefore the suggested probe settings are lower than other rare or medium rare meats.

# Cleaning

## ⚠ WARNING!



### Hot Surface and Electrical Shock Hazard

Make sure all oven controls are turned off and the oven is cool before cleaning.

Failure to do so could result in electrical shock or burns.

## Important!

Do not use harsh/abrasive cleaning agents, waxes, pumice cleaners, polishes or commercial oven cleaners to clean your oven.

## Important!

If you choose to use a commercial stainless steel cleaner, please read the label to make sure it does not contain chlorine compounds as these are corrosive and may damage the appearance of your oven. Clean the stainless steel surfaces with the grain, in a horizontal motion.

## Cleaning the control panel

It may be useful to lock the oven controls prior to cleaning – see 'Control panel lock' in 'User Select options' for details.

### Brushed and Iridium stainless steel

- Clean with a commercial stainless steel cleaner, see 'Important' above, or wipe with a clean damp cloth and dry with a lint-free cloth.
- Regular use of a stainless steel cleaner will reduce fingerprints and other marks.
- Do not use abrasive cleaners on stainless steel, as they will permanently damage the surface.

## Cleaning the glass door

- Clean the exterior glass surface with a mild solution of detergent and warm water.
- Use a glass cleaner to remove any smears or fingerprints.
- Dry the glass using a soft lint-free cloth.

Note: The interior oven door glass will be cleaned during a self-clean cycle.

## Cleaning the porcelain enamelled surfaces

The oven interior and inner door liners are porcelain enamelled and are cleaned during the self-clean cycle.

### Important!

- Do not use any oven cleaners, oven cleaning products or abrasives on the porcelain enamel.
- Do not clean the door seal (gasket) or cavity seal or use any oven cleaning products on them. They are essential for a good seal and the efficient operation of the oven and care should be taken not to rub, damage or move the seals.

## Cleaning the three-piece broil/roast system and oven shelves and shelf supports

- The broil/roast system, oven shelves and self supports can be cleaned using a solution of detergent and hot water. They are also dishwasher safe.
- If particularly soiled, soak in a solution of hot water and biological clothes washing powder to make cleaning easier.

### To remove the shelf supports

- 1 Lift the lever to unlock the shelf support.
- 2 Lift the shelf support up and away from the side wall of the cavity to clear the locating pin.
- 3 Pull the shelf support toward you and out of the oven.

### To replace the shelf supports

- 1 Align the two notches on the rear edge of the shelf support with the two pins to the rear of the oven cavity.
- 2 Replace the front of the shelf support against the wall of the oven cavity. Be sure the locating pin slots into place.
- 3 Lock the shelf support into position by shifting the lever into the horizontal position where it will 'click' into place.

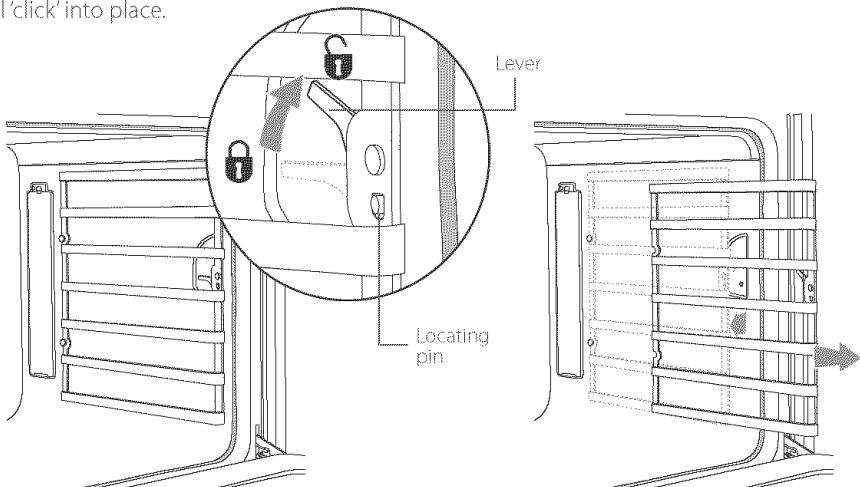



## SELF CLEAN mode

- This oven features a pyrolytic self-clean cycle.
- During a self-clean cycle the oven reaches higher temperatures than it does for cooking and this burns off and breaks down soil and grease deposits.
- A smoke eliminator and active venting system removes and breaks down the smoke, fumes and odors.
- The ash residue that remains is easily removed from the cool oven with a small brush and a damp cloth or sponge.
- A self-clean cycle normally takes about three hours. This time can be reduced to as low as two hours.
- Only one oven in a double oven can be self-cleaned at a time.
- When one oven is in a self-clean cycle, the other oven cannot be used for cooking.

### **Important safety instructions**

- Wipe up any large food spills or grease deposits before starting a self-clean cycle.
- Do not use oven cleaners. Do not use any commercial oven cleaner, oven liner or protective coating of any kind in or around any part of the oven.
- Remove oven shelves and shelf supports (see 'Cleaning') before starting a self-clean cycle. If left in the oven, they will permanently discolour.
- Do not use your oven to clean miscellaneous parts.
- Do not clean the door seal or cavity seal, or use any oven cleaning products on them. They are essential for the efficient operation of the oven and care should be taken not to rub, damage or move them.

## Using the SELF CLEAN mode

- 1 Remove oven shelves, shelf supports (see 'Cleaning') and all other cookware/utensils from the oven before using the SELF CLEAN mode.
- 2 Select the SELF CLEAN mode by turning the oven mode dial.
- 3 Turn the temperature dial to its maximum position.  will appear in the display and this will change to  when the cycle begins. The **DOOR LOCK** and **CLEAN** symbols will show in the clock display and the time remaining will count down.

**For your safety the door lock will automatically activate once the SELF CLEAN mode and temperature have been selected.**

- 4 At the end of a self-clean cycle, the door will unlock and the **DOOR LOCK** symbol will disappear. The **CLEAN** symbol and  will flash in the clock display and **SELF CLEAN** will show in the mode display until the oven is returned to manual operation – to do this turn the oven mode and temperature dials to OFF.
- 5 At the completion of the self-clean cycle, you will notice grey ash deposited inside the oven. The amount of ash in the oven is dependent on the amount of soil present in the oven before it was cleaned. When the oven is completely cooled, the ash is easily removed with a small brush or dry cloth, then wipe out the oven with a clean damp cloth and dry with a clean lint-free cloth.
- 6 Replace the shelf supports (see 'Cleaning') and oven shelves.

### To cancel the SELF CLEAN mode before it has finished

Turn the oven mode and temperature dials to OFF. **CLEAN COOL** will appear in the oven mode display and the door will remain locked until **CLEAN END** appears.



## Important!

**Do not turn off the mains power supply to the oven. The fans are needed to cool the oven.**

Once the oven is cool or below the safe temperature it will return to normal operation and the clock display will show the time of day.



### Short SELF CLEAN cycle

A shorter self-clean cycle can be selected if the oven is only lightly soiled:

- 1 Select the SELF CLEAN mode by turning the oven mode dial.
- 2 Turn the temperature dial to its maximum position.  will appear in the display.
- 3 While  is showing press the **COOK TIME** button. The **COOK TIME** and **AUTO** symbols and the colon will flash.
- 4 Rotate the **PUSH TO CLEAR**  button to reduce the time: this can be anywhere between two and three hours.
- 5 Press the **COOK TIME** button again, or wait eight seconds to adopt the setting and start the self-clean cycle. The clock display will show the time remaining.

## SELF CLEAN – delayed start

Your Aerotech® oven can be set to start a self-clean cycle at your convenience:

- 1 Check that the clock shows the correct time.
- 2 Select the SELF CLEAN mode by turning the oven mode dial.
- 3 Turn the temperature dial to its maximum position.  will show in the temperature display.
- 4 While  is showing, press the **STOP TIME** button. The **STOP TIME** and **AUTO** symbols and the colon will flash.
- 5 Set the time that you want the oven to finish by rotating the **PUSH TO CLEAR**  button. If there is time to wait before the self-clean cycle starts, **AUTO** and **DELAY CLEAN** will appear in the clock display.
- 6 When the self-clean cycle starts, **AUTO, DOOR LOCK** and **CLEAN** will appear in the display and the time remaining will count down.

# Troubleshooting

## Fault codes

If there is a fault, the oven will beep every second, and a fault code will appear in the clock display as a letter 'F' with a number after it.

## Important!

**Do not turn off the main power supply to the oven if you get a fault code. The fans are needed to cool the oven.**

**For safety, this oven is designed to self-cool. Turning off the power while the oven is hot may damage the oven and its surrounding cabinetry.**

If you get a fault code:

- 1 Note the fault code.
- 2 Turn the temperature and oven mode dials to OFF.
- 3 Press the **PUSH TO CLEAR**  button. The oven may have already self-corrected, and this will be enough to clear the fault.
- 4 Call your Fisher & Paykel Authorised Service Centre with the fault code information.

Note: if you are unable to immediately clear the fault code or contact your Fisher & Paykel Authorised Service Centre, wait for the oven cooling fans to stop, and then press the **PUSH TO CLEAR**  button again. It is likely that the oven will now clear the fault. If it does not, then you may turn the oven off at the wall **once the fans have stopped** and **the oven has completely cooled down**.

Problem	Possible cause	What to do
Oven does not work.	Power supply is not connected.	Have a service company/electrician check power connections, wiring and fuses.
	Clock is not set due to power cut or failure.	The clock must be set before the oven can be used. The oven will go into 'Set Up' mode when the electricity is restored after a power cut. The oven mode and temperature displays will show OFF. Both displays will be unlit and unresponsive. The colon (:) in the clock display will flash. See 'Setting the clock'.
	Oven door is open.	The elements are disabled by the door switch when the door is open. Make sure the door is properly closed.

Continued...

<b>Problem</b>	<b>Possible cause</b>	<b>What to do</b>
<b>Oven door will not open.</b>	Oven door is locked.	Still in SELF CLEAN mode. The door will unlock when the cycle has finished and the oven has cooled to a safe temperature.
<b>Baked foods too brown on top or bottom.</b>	Oven not preheated.	Preheat until the temperature display changes from orange to green (or orange to blue on Iridium stainless steel models).
	Baking pans/tins too large or too small for the recipe.	Use the correct sized pans/tins.
	Baking pans/tins not evenly spaced on shelves.	Stagger baking pans on the oven shelves so that there is at least 1 1/8" (3 cm) between them and the oven walls.
	Baked products, eg biscuits, not evenly sized or spaced on cookie sheet.	Make baked products the same size and shape and space them evenly over the cookie sheet.
	Shelf position too high for specific mode.	Try a lower shelf position.
	Opening the oven door frequently during baking.	Do not open the door until at least 3/4 of the cooking time has passed.
	Baking temperature too high or too low.	Adjust temperature.
<b>Oven light does not work.</b>	Light bulb has blown.	Replace the light bulb. Refer to 'Maintenance' for details.
<b>Oven not heating.</b>	Oven door is not properly closed or opened too frequently during operation.	Oven elements and fans turn off while the door is open so be sure the oven door is properly closed. Note: broil modes are designed to operate with the door closed.
<b>Baked foods are pale and under-cooked.</b>	Shiny cookie sheets, tins, or pans being used from a previous oven with an unconcealed lower element.	Shiny cookie sheets, tins, and pans reflect the heat back towards the bottom of the oven resulting in poor cooking performance. Food tends to take longer to cook and does not brown well. The dark coloured accessories supplied with the oven work efficiently by absorbing heat and may reduce cooking times.

# Maintenance

## ⚠ WARNING!



### Electrical Shock Hazard

Ensure the appliance is switched off before replacing the lamp/light bulb.

Failure to do so could result in electrical shock.

## How to change the oven light bulbs

The oven is illuminated by three 12 volt/20 watt halogen bulbs. These have a very long life, but if you should need to replace one, follow these steps:

- 1 Turn the oven off and allow it to cool.
- 2 Take out the shelves and use a small flat head screwdriver to twist and lift the retainer clip at the top of the glass light cover while holding the glass to prevent it falling. The clip pivots counter-clockwise (see the diagrams below).
- 3 Carefully lift the glass cover out of the lower support and pull out the faulty bulb.
- 4 Holding the replacement bulb in a soft cloth or tissue (touching the bulb will reduce its life span), insert the new bulb. The two pins are vertically orientated.
- 5 Reposition the glass cover and twist the top clip back in place. The procedure is the same for the light in the roof of the oven cavity.

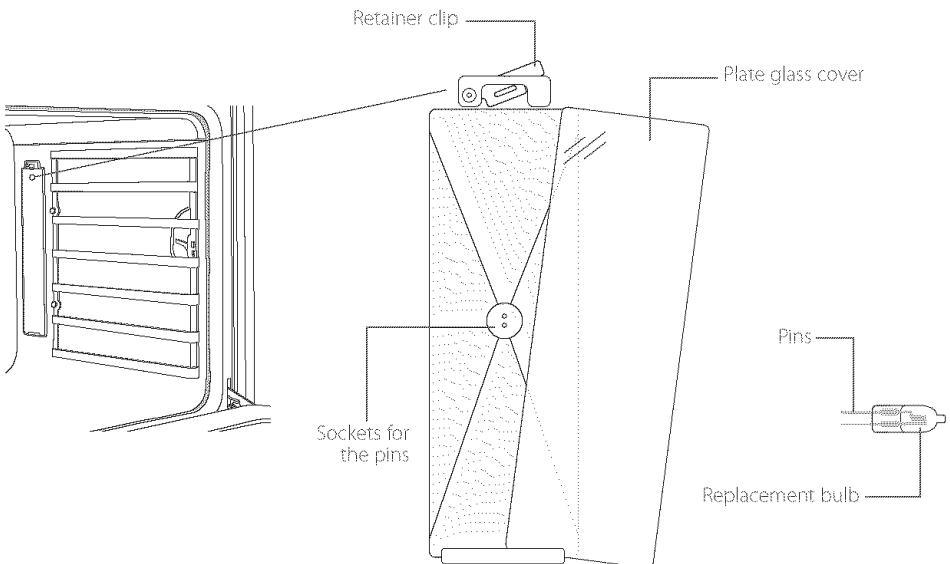

# Limited warranty

When you purchase any new Fisher & Paykel whiteware product for personal or consumer use you automatically receive a two year limited warranty covering parts and labor for servicing within the 48 mainland United States, Hawaii, Washington DC and Canada. In Alaska the limited warranty is the same except that you must pay to ship the product to the service shop or the service technician's travel to your home. Products for use in Canada must be purchased through the Canadian distribution channel to ensure regulatory compliance.

If the product is installed in a motor vehicle, boat or similar mobile facility, you receive the same two year limited warranty, but you must bring the vehicle, boat or mobile facility containing the product to the service shop at your expense or pay the service technician's travel to the location of the product.

## **Fisher & Paykel undertakes to:**

Repair without cost to the owner either for material or labor any part of the product, the serial number of which appears on the product, which is found to be defective. In Alaska, you must pay to ship the product to the service shop or for the service technician's travel to your home. If the product is installed in a motor vehicle, boat or similar mobile facility, you must bring it to the service shop at your expense or pay for the service technician's travel to the location of the product. If we are unable to repair a defective part of the product after a reasonable number of attempts, at our option we may replace the part or the product, or we may provide you a full refund of the purchase price of the product (not including installation or other charges).

This warranty extends to the original purchaser and any succeeding owner of the product for products purchased for ordinary single-family home use.

All service under this Limited Warranty shall be provided by Fisher & Paykel or its Authorized Service Agent during normal business hours.

## **How long does this Limited Warranty last?**

Our liability under this limited warranty expires TWO YEARS from the date of purchase of the product by the first consumer.

Our liability under any implied warranties, including the implied warranty of merchantability (an unwritten warranty that the product is fit for ordinary use) also expires ONE YEAR (or such longer period as required by applicable law) from the date of purchase of the product by the first consumer. Some states do not allow limitations on how long an implied warranty lasts, so this limit on implied warranties may not apply to you.

## This warranty does not cover:

- A** Service calls that are not related to any defect in the product. The cost of a service call will be charged if the problem is not found to be a defect of the product. For example:
  1. Correcting faulty installation of the product.
  2. Instructing you how to use the product.
  3. Replacing house fuses, reset circuit breakers, correct house wiring or plumbing, or replace light bulbs.
  4. Correcting fault(s) caused by the user.
  5. Changing the set-up of the product.
  6. Unauthorized modifications of the product.
  7. Noise or vibration that is considered normal, for example, drain/fan sounds, regeneration noises or user warning beeps.
  8. Correcting damage caused by pests, for example, rats, cockroaches etc.
- B** Defects caused by factors other than:
  1. Normal domestic use or
  2. Use in accordance with the product's user guide.
- C** Defects to the product caused by accident, neglect, misuse, fire, flood or Act of God.
- D** The cost of repairs carried out by non-authorized repairers or the cost of correcting such unauthorized repairs.
- E** Travel fees and associated charges incurred when the product is installed in a location with limited or restricted access (eg airplane flights, ferry charges, isolated geographic areas).
- F** Normal recommended maintenance as set forth in the product's user guide.

If you have an installation problem contact your dealer or installer. You are responsible for providing adequate electrical, exhausting and other connection facilities.

We are not responsible for consequential or incidental damages (the cost of repairing or replacing other property damaged if the product is defective or any of your expenses caused if the product is defective). Some states do not allow the exclusion or limitation of incidental or consequential damages, so the above limitation or exclusion may not apply to you.

## How to get service

Please read your user guide. If you then have any questions about operating the product, need the name of your local Fisher & Paykel Authorized Service Agent, or believe the product is defective and wish service under this limited warranty, please contact your dealer or call us at:

**TOLL FREE US & CA 1-888-9-FNP-USA (1-888-9-367-872)**

or contact us through our web site: [www.usa.fisherpaykel.com](http://www.usa.fisherpaykel.com)

You may be required to provide reasonable proof of the date of purchase of the product before the product will be serviced under this limited warranty.

## Commercial use

If you are using the product in a commercial setting (any use other than a single family dwelling), we agree to repair or replace, without cost to you for parts only, any defective parts, the serial number of which appears on the product. Our liability for these repairs expires ONE YEAR from the date of original purchase.

At our option we may replace the part or the product, or we may provide you a full refund of the purchase price of the product (not including installation or other charges). All service under this limited warranty shall be provided by Fisher & Paykel or its Authorized Service Agent during normal business hours.

## No other warranties

This limited warranty is the complete and exclusive agreement between you and Fisher & Paykel regarding any defect in the product. None of our employees (or our Authorized Service Agents) are authorized to make any addition or modification to this limited warranty.

Warrantor: Fisher & Paykel Appliances, Inc.

If you need further help concerning this limited warranty, please contact us at:

Fisher & Paykel Appliances, Inc.  
5900 Skylab Road  
Huntington Beach  
CA 92647

This limited warranty gives you specific legal rights, and you may also have other rights which vary from state to state.



Copyright © Fisher & Paykel 2005. All rights reserved.  
The product specifications in this booklet apply to the  
specific products and models described at the date  
of issue. Under our policy of continuous product  
improvement, these specifications may change at any  
time. You should therefore check with your Dealer to  
ensure this booklet correctly describes the product  
currently available.

[www.fisherpaykel.com](http://www.fisherpaykel.com)

S. C.A.

Product Booklet

Published 01/2005

Technical Drawing

Part No. 391041