

# Operating and Installation Instructions



Washer  
PW 6241  
PW 6321

To prevent accidents  
and appliance damage  
read these instructions  
**before**  
installing or use.

en - US, CA

M.-Nr. 06 572 435



<b>IMPORTANT SAFETY INSTRUCTIONS</b> . . . . .	4
<b>Guide to the washer</b> . . . . .	7
Operating panel . . . . .	8
<b>Use</b> . . . . .	10
1. Turn on the washer . . . . .	10
2. Sort and load the laundry . . . . .	10
Maximum dry laundry weights . . . . .	11
3. Add detergent. . . . .	11
4. Select a program . . . . .	14
5. Select wash options (if needed) . . . . .	14
6. Adjust the program (if needed) . . . . .	15
7. Select Delay Start (if needed) . . . . .	16
8. Start the program . . . . .	16
9. End of program. . . . .	17
Skipping program cycles . . . . .	18
Program stop . . . . .	18
Program end with water in the drum. . . . .	18
Canceling a program . . . . .	19
Program sequence . . . . .	20
<b>i</b> Information . . . . .	20
Language selection . . . . .	21
<b>Chip card use</b> . . . . .	22
Card operation . . . . .	22
<b>Optional modules</b> . . . . .	23
Liquid dispensing system. . . . .	23
Peak load cutoff . . . . .	25
Communication module . . . . .	25
Load module. . . . .	25
<b>Cleaning and Care</b> . . . . .	26
After each use. . . . .	26
Cleaning the exterior. . . . .	26
<b>Frequently asked questions</b> . . . . .	29
Power failure - Emergency door release . . . . .	30
Fault messages. . . . .	31
<b>After sales service</b> . . . . .	33
<b>Guide to the data plate symbols</b> . . . . .	34
<b>Help to protect the environment</b> . . . . .	36
<b>Installation Instructions</b> . . . . .	37
Installation site . . . . .	37
Removing the shipping struts . . . . .	37
Plumbing. . . . .	38
Connecting the water intake / water drain hoses . . . . .	38
Electrical connection . . . . .	39
<b>Quick Guide</b> . . . . .	40

# IMPORTANT SAFETY INSTRUCTIONS

## Explanation of safety instructions and warnings on the washer



Read the operating instructions.

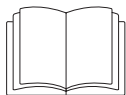

Read all the instructions, e.g. the installation instructions.



Caution, hot surfaces.



Caution, voltage up to 1000 V



Grounding

## Correct usage of the washer

▶ Only use the washing machine to wash items which are specified by the manufacturer to be machine washable on the fabric care label. Any other applications may be dangerous.

▶ Persons who lack physical, sensory or mental abilities, or experience with the appliance should not use it without supervision or instruction by a responsible person.

▶ This washer-extractor is only intended for laundry which has not come in contact with flammable substances.

▶ Dry cleaning solvents must not be used in this machine. Such solvents could cause a fire or explosion.

▶ Do not wash articles that have been previously cleaned, washed, soaked or spotted with gasoline, dry-cleaning solvents, organic oils or other flammable substances. These articles give off vapors that could ignite or explode. Do not add these items to the wash load.

▶ **CAUTION: Fire hazard!**

Do not store or use gasoline, gasoline-based substances or any easily flammable materials near the machine. Do not use the top of the washer as a storage area.

▶ Do not store any chemicals (liquid detergents, wash aids) on the top of the washer. The chemicals could damage the surface. Spilled chemicals must be immediately washed off with a wet sponge.

▶ Under certain conditions, hydrogen gas may be produced in a hot water system that has not been used for 2 weeks or more. **HYDROGEN GAS IS EXPLOSIVE.** If the hot water system has not been used for such a period, turn on all hot water faucets and let the water flow from each for several minutes before using the washing machine. This will release any built-up hydrogen gas. Do not smoke or use an open flame during this time, the gas is flammable.

▶ Check the wash results when the laundry was soiled with biological oils or grease. If the laundry is not sufficiently cleaned, a spontaneous combustion might occur when the laundry is dried in a dryer. Use special detergents or wash programs.

▶ If the washer is operated in a publicly accessible area, the operator must ensure the safe use of the appliance.

▶ Ensure that any one operating this machine is familiar with these important safety instructions.

## READ AND SAVE THESE INSTRUCTIONS

**Keep these operating instructions in a safe place and pass them on to any future user.**

**Read all instructions before installation or use of the washer to prevent injury and machine damage.**

**Installation, repair and maintenance work should be performed by a Miele authorized service technician. Work by unqualified persons could be dangerous.**

**This appliance complies with current safety requirements. Improper use of the appliance can lead to personal injury and material damage.**

**All personnel working with this machine must be fully trained in all aspects of its use and safety.**

## Electrical Safety

- ▶ Be certain this appliance is properly installed and grounded by an authorized technician. For electrical safety this machine must be grounded. It is imperative that this basic safety requirement be tested by a qualified electrician. Consult a qualified electrician if in doubt.
- ▶ Repairs to electrical or steam appliances should only be carried out by a Miele authorized technician in accordance with local and national safety regulations. Unauthorized repairs could cause injury or machine damage.
- ▶ Do not repair or replace any part of the appliance or attempt any servicing unless specifically recommended in these operating instructions. Contact Miele's Technical Service Department for assistance.
- ▶ Do not damage, remove, or bypass any of the safety features and controls of the washer.
- ▶ Do not operate the appliance if the control panel, wires or cables are damaged.
- ▶ Do not operate the washer when housing parts have been removed and the moving or electrical parts are exposed and accessible.
- ▶ The washer is only completely isolated from the electrical supply when the circuit breaker has been tripped or the power main shut off.
- ▶ Do not use force to open the washer drum door. The door handle is equipped with an extra safety mechanism to guarantee that the door remains locked.
- ▶ Faulty components must only be replaced with genuine Miele spare parts to guarantee the safe operation of this machine.

## Use

- ▶ Do not let children play in, on or near the washer. Do not let them play with the controls or operate the unit. Close supervision of children is necessary when the appliance is used near children.
- ▶ Always close the door after loading or unloading the washer, to prevent:
  - children from climbing into the washer, or hiding small items in the washer.
  - small animals from climbing into the washer.
- ▶ The drum door glass will be hot when washing at very high temperatures. Do not touch the glass.
- ▶ Do not reach into the appliance if the drum is moving.
- ▶ Take care not to pinch or cut your fingers on the hinges of the drum door or lint flap. Use the handles.
- ▶ The area necessary to open the drum door completely must not be obstructed by doors or other structures.
- ▶ Do not drink washer water! Harmful residues could be present.
- ▶ Always follow the instructions of the chemical manufacturer when using cleaning agents and special application chemicals. Only use such chemicals for the purpose and in the situation specified by the manufacturer. This will prevent the danger of adverse chemical reactions and material damage.  
If in doubt, check with the manufacturer to be sure that the product is suitable for use in this machine.
- ▶ Dyes, dye removers and descaling agents may only be used in this machine if the manufacturer states they are suitable for use in a washing machine. Always observe the manufacturer's instructions carefully.
- ▶ Fabric softeners may be used with this machine. Follow the manufacturers instructions.
- ▶ Do not use high pressure cleaners to hose down the washer.
- ▶ Check the hoses regularly for leaks to prevent water damage.
- ▶ Do not tamper with the controls.

# IMPORTANT SAFETY INSTRUCTIONS

## Additional information

▶ Disinfecting and cleaning agents often contain chlorides (salts) which can cause steel surfaces to rust. To protect the machine from rust damage, only use chloride free disinfecting and cleaning agents for washing/disinfecting and for cleaning the machine. If you are not sure about an agent contact Miele's Professional Department. If you accidentally spill an agent containing chloride on the machine it should be rinsed off with water and dried with a soft cloth.

▶ The manufacturer of the washer does not take responsibility for the effect of the chemical on the laundry or the machine when a chemical cleaning agent is recommended on technical application grounds.

▶ Keep the area around the machine clean and free of debris.

▶ Before the appliance is removed for service or discarded, remove the door.

▶ The interior of the machine should be cleaned periodically by a qualified service agent.

## Using accessories

▶ Only use genuine Miele accessories. If other parts are used, guarantee, performance and product liability claims may become void.

## Chlorine damage to components

### How to handle chlorine bleach and perchloroethylene (PCE)

▶ Heavy use of chlorine products increases the risk of damage to appliance components.

Depending on the chlorine concentration, the exposure time, and the temperature, the use of liquid and powdered chlorine-based bleaches can erode the stainless steel protective layer and lead to corrosion of the appliance components. Therefore, it is recommended that these products not be used. Instead you can use oxygen-based bleaches.

If you still need to use chlorine-based bleaches in special cases, you will need to perform a neutralizing step each time. Failure to do so can result in permanent and irreversible damage to the washing machine and the laundered items.

### Chlorine neutralization

Chlorine neutralization must be done immediately following the use of a chlorine-based bleach. For best results, use hydrogen peroxide or an oxygen-based laundry soap or bleach, without draining the tub.

If thiosulfate is used (especially with hard water), lime deposits can form, leading to residue on the laundered items or a build-up in the washing machine. The preferable alternative is to use hydrogen peroxide, because it helps promote the neutralization of chlorine.

The exact amounts to be used, and at what temperature(s), should be selected based on the recommendations of the neutralizer manufacturer, then checked for efficacy. The laundry will need to be tested to ensure that no active chlorine remains behind after neutralization.

## SAVE THESE INSTRUCTIONS

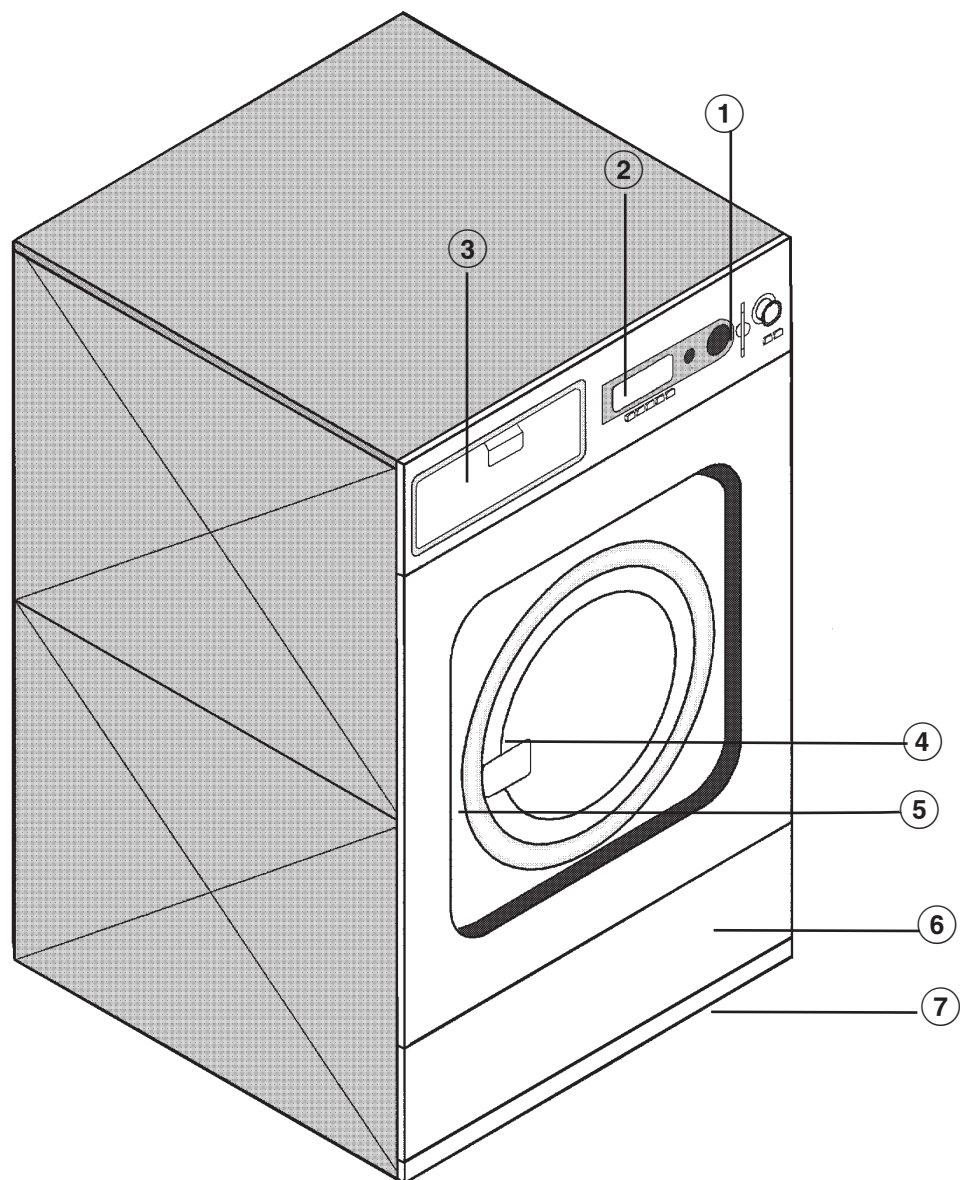

① **Emergency Stop button**

Pressing the red button turns the machine off.

② **Control panel**

③ **Detergent compartments**

Pull the handle to open the flap.

④ **Drum door**

Pull the door handle to open the drum door. Do not use force.

⑤ **Door handle**

The door handle is equipped with an extra safety mechanism to guarantee that the door remains locked.

⑥ **Service panel**

⑦ **Plinth**

## Operating panel



### ① Display\*

1	Hot Wash	194 °F
2	Cottons	140 °F
3	Cottons Intensive	140 °F

Icons at the bottom of the display: a hand, a plus/minus sign, and a refresh symbol.

After turning the machine on, the display shows briefly a welcome screen and switches to the program list. The last started program is highlighted.

### ② Control keys

The control keys have different functions depending on the machine status. The functions are shown in the display above each button.

If programmed to "Button allocation direct", the first 6 programs from the program list can be selected directly with the control keys 1 to 6.

### ③ Start button

The circle illumination flashes if a selected program can be started. To start a program press the "Start" button. Once a program has started the Start button can be pressed to show the original display.

\* Contents in the display will vary with program offering.

### ④ Optical interface PC

The optical interface on the machine's control panel provides the connection point for data transfer between the machine's controls and a PC.

### ⑤ Jog shuttle

**Turn** the jog shuttle to display selections and input fields.

**Press** the jog shuttle to confirm display selections or changes.

### ⑥ Card reader

For card operation. Washing programs can be uploaded and downloaded on the program card. The programs on the card can be used to operate the washer.

### ⑦ I On button

Turns the machine on.

### ⑧ 0 Off button

Turns the machine off.

### ⑨ Emergency Stop button

Only use in case of an emergency.

■ Press the red button to turn the machine off. After clearing the danger turn the button clockwise to unlock it.

■ Press "Start" to continue the interrupted program.

## Control keys

■ Press once to activate the function, press again to deactivate the function.

 Manual operation  
(Used by Miele Service Technicians)  
See Programming Manual.

 Functions  
Press this key to temporarily select another language and/or access the Supervisor level.

 Back to the previous display

+  Block plus  
The respective program block (e.g. prewash) will be added to the program.

 Starch Stop  
Press this button to stop the program and allow starch to be added to the laundry.

 Spin Stop  
Press this button if a final spin is not required after the final rinse.

 Delay start  
Press this key to select a start time in the display.

**i** Information  
To show program information

 Stop/Finish  
Press to stop a selected program or end an already stopped program.

 Drain

 Skip  
Cycles of a program in progress can be skipped or repeated.

 Following or previous line

 Save  
See Programming Manual

 Program locked  
If a program is locked it cannot be stopped or ended with the **0** "Off" button after 1 minute.

 Program unlocked

 Dispensing

 Dispensing not available

 Operating data

 Reset to 0 (zero)  
To reset the load sensor to "00.0" when the drum is empty and the display shows a load size.

D Data transfer

## Operator Card

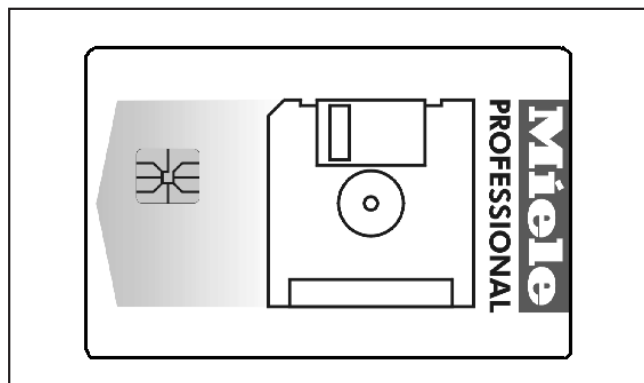

No programs are saved on this card. To transfer the data from the control to the card and vice versa see Programming Manual.

30 programs containing 6 blocks each can be saved on the card.

The rear side of the card can be labeled.

# Use

## 1. Turn on the washer

- Open the on-site water faucet (and the supply faucet for steam, if relevant).
- Turn on the electrical supply at the mains (on site).
- Press **I** "On" to turn the washer on.

The welcome screen shows.



Then the program list is shown. The last started program is highlighted.

1	Hot Wash	194 °F
2	<b>Cottons</b>	<b>140 °F</b>
3	Cottons Intensive	140 °F

Below the program list, there are four icons: a hand, a laundry basket, a pair of pants, and a circular arrow.

## 2. Sort and load the laundry

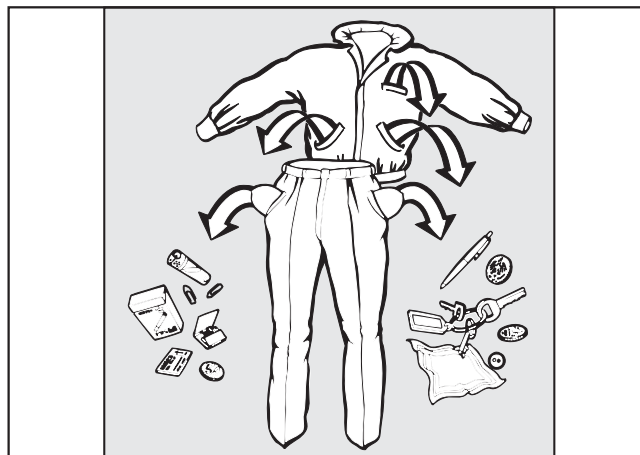

- Empty all pockets.

Foreign objects left in pockets (e.g. nails, coins, paper clips, etc.) can cause damage to clothes and the machine.

- Sort the laundry.
- Only wash fabrics according to this wash care label.
- Open the drum door by pulling the handle.
- Load the laundry loosely into the drum.

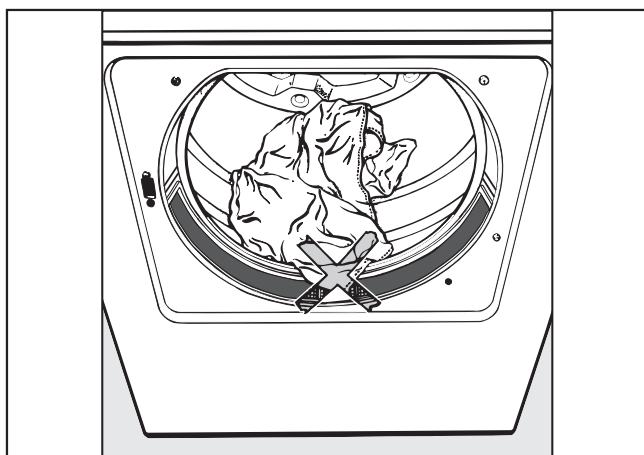

To prevent fabric damage, check that laundry will not be caught in the closed door.

- Close the drum door with the handle. Do not swing the door shut.

### Maximum dry laundry weights

PW 6241

54 lbs / 24 kg laundry

35 lbs / 16 kg wet cleaning

PW 6321

72 lbs / 32 kg laundry

42 lbs / 19 kg wet cleaning

### 3. Add detergent

- Open the detergent compartment flap, pull out the respective containers and add detergent.

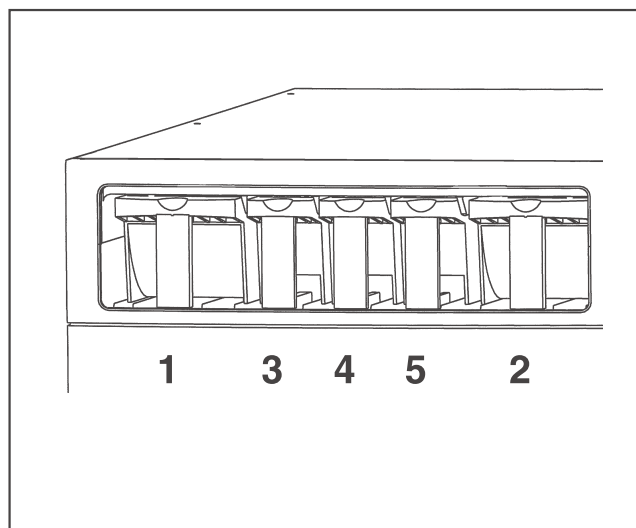

- For standard programs add detergent to compartment:
  - 2** = for the main wash
  - 1** = for the Prewash (if required)
  - 3** = fabric softener
  - 4** = liquid bleach
  - 5** = liquid detergent

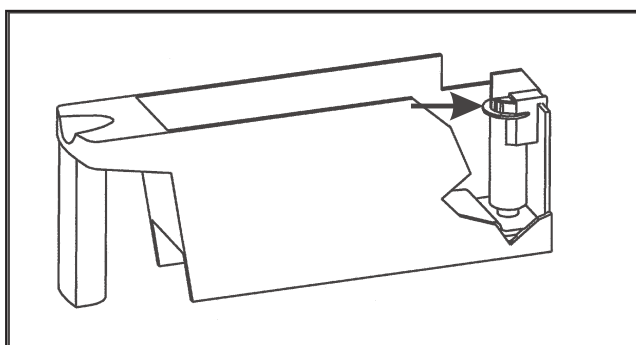

- Do not exceed the maximum fill level, the excess will flow directly into the drum.
- Close the detergent compartment.

# Use

## Detergent

Only use the correct amount of high efficiency low sudsing detergent. Too much detergent will cause oversudsing.

### Dosage

Follow the instructions on the detergent packaging to ensure the correct usage and dosage amount for your water hardness.

Adjust the amount of detergent if the load is smaller and more or less soiled than normal.

### Water hardness

Water hardness levels	Water quality	Hardness level in mmol/l	German hardness °d
I	soft	0 - 1.3	0 - 7
II	moderate	1.3 - 2.5	7 - 14
III	hard	2.5 - 3.8	14 - 21
IV	very hard	over 3.8	over 21

If you do not know the water hardness in your area contact your local water authority.

## Fabric softener

- Pour liquid fabric softener into the compartment according to the manufacturer's instructions. **Do not exceed the maximum fill level**, the excess will prematurely activate the siphon and be wasted.
- Close the compartment lid and push in the dispenser drawer.

The fabric softener will automatically be dispensed during the final rinse cycle.

A small amount of water will remain in the compartment at the end of the program.

Never mix fabric softener and starch in the fabric softener compartment, **3**. This will clog the dispenser.

## Starch

### In the detergent container

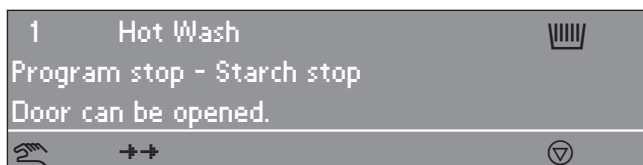

"Program stop - Starch Stop" flashes in the display when it is time to add starch to the laundry.

- Add starch prepared according to manufacturer's instructions into compartment **3, 4** or **5**. The wash time is automatically extended by 4 minutes.
- Press "Start" to continue the program.

### In the drum

- Once the program stops in "Starch Stop", open the drum door and add starch to the laundry load prepared according to the manufacturer's instructions.
- Close the drum door.

The display shows:

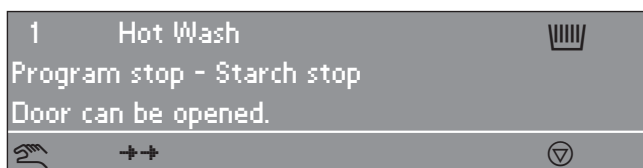

- Press the "Start" button to continue the program.

## Bleach

Only bleach items with the  $\Delta$  symbol on the fabric care label.

Liquid bleach can only be used in a program designed for bleach. Add bleach to compartment, **4**, only. It will be automatically added to the second rinse.

A third rinse is necessary when using bleach (see the Programming Manual).

 With increased use of chlorine the possibility of machine damage rises.

## Fabric dye

Fabric dye and color aids must be suitable for use in a washer. Always follow the instructions of the manufacturer.

## 4. Select a program

- Select a program by turning the jog shuttle (e.g. Program 1 Hot Wash).

The following will appear in the display:

18	Extra Drain	
1	Hot Wash	194 °F
2	Cottons	140 °F

- See the Programming Manual for more information.
- Confirm the selected program by pressing the inner button of the jog shuttle.



The display shows:

1	Hot Wash	54.0 /54.0 lb
194 °F	Main wash	
	Rinse	1100 rpm

## 5. Select wash options (if needed)

- Press one of the wash option buttons.  
To deselect the option, press it again.

### + Block Plus

A pre-wash can be selected for heavily soiled laundry in certain programs. If a pre-wash is an option the "+" field is highlighted. If a pre-wash is not available, the "+" will not be shown.

### Starch Stop

Starch can be selected with all standard programs (excluding Extra Spin and Extra Drain). The  field is highlighted in the display.

### Spin Stop

Spin Stop can be selected with all standard programs (excluding Extra Spin). The  field is highlighted in the display.

## 6. Adjust the program (if needed)

### Laundry weight

The laundry weight can be manually selected.

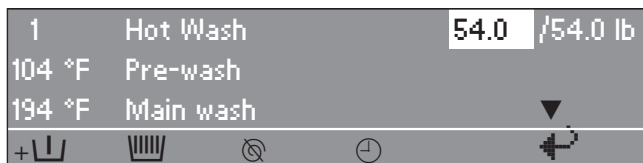

- Turn the jog shuttle to "Laundry weight" and press to confirm the selection.

The weight shown on the right side indicates the max. weight.

- Turn the jog shuttle to the desired laundry weight and press to confirm the selection.

### Temperature

In 1°F steps from cold to the maximum program temperature.

- Turn the jog shuttle to "Temperature" (104 °F for Pre-wash) and press to confirm the selection.

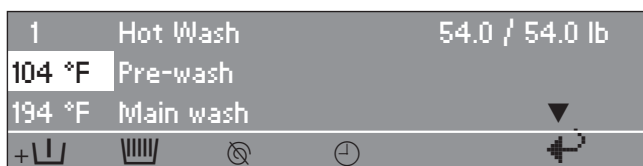

- Turn the jog shuttle to the desired temperature and press it to confirm the selection.

### Spin speed

The spin speed can be adjusted from 0 - 300 in 25 rpm increments. Depending on the machine model and the program selected the max. spin speed ranges from 600 - 1100 rpms.

- Turn the jog shuttle to "Spin speed" and press to confirm the selection.

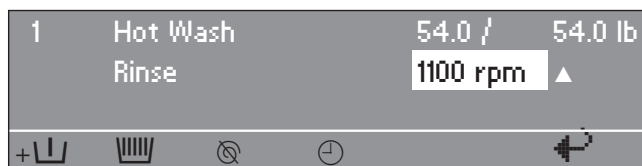

- Turn the jog shuttle to the desired spin speed and press it to confirm the selection.

## 7. Select Delay Start (if needed)

Use the ⊖ "Delay start" button to program the washer to start automatically at a later time.

### Setting the delay start

- Press ⊖ "Delay Start".

The following will appear in the display:

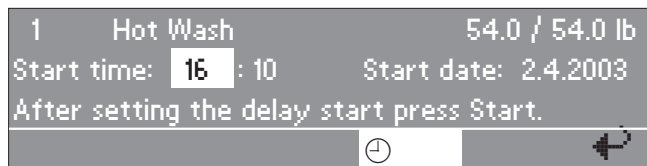

The display shows the current time of day and date. The entry field is highlighted for hours.

- Press, then turn the jog shuttle to select the hour. Press it to confirm the selection.
- Repeat with the minutes, day, month and year.
- Press the "Start" button to start the program at the selected start time.

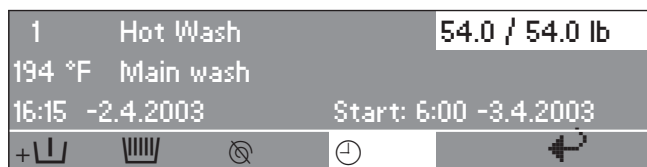

The display shows the current time of day, date and the start time.

- If the door is opened before the delay start time has elapsed, press the "Start" button again.

### Canceling the Delay Start

- Press ⊖ "Delay Start" again or the ↶ "Back" button to cancel the delay start function.

## 8. Start the program

- Press the "Start" button to start the program.

When using the "Spin Stop" wash option, "Without spin" will flash in the display when the spin cycle is reached.

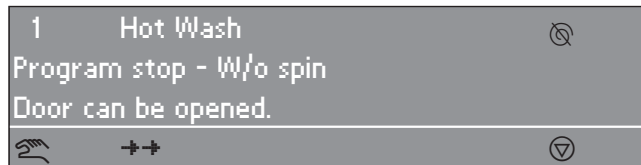

- To continue the program **with** spinning, press the "Start" button.
- Press the ⊖ "End" button to end the program **without** spinning.

## 9. End of program

At the end of the program, once the drum is stationary and no water is in the machine the display shows (for example):



At the same time a tone will sound for a short time to signal the program end.

- Pull the door handle to open the drum door.

Important: If the door cannot be opened, press against the door handle then pull again. **Do not use force!**

- Remove the laundry.
- Leave the drum door open to air dry the interior.
- Turn the machine off with the **0** "Off" button.
- Turn the mains off (on-site).
- Close the steam valve (on-site).

## Skipping program cycles

Cycles of a program in progress can be skipped or repeated.

- Press the  "End" button to stop the program.



- Press the  "Skip/Repeat" button. The display shows the current area, block or step. See also "Program structure" in the Programming Manual.

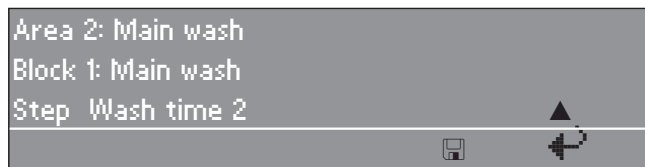
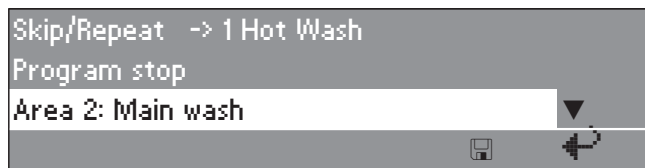

- Turn the jog shuttle to "Area" and press it to confirm the selection.  
Area: Select either 1 Prewash, 2 Main wash or 3 Rinse and confirm by pressing the jog shuttle.
- Turn the jog shuttle to "Block" and press it to confirm the selection.  
Block: Select either Prewash 1-10, Main wash 1-10 or Rinse 1-10 and confirm by pressing the jog shuttle.
- Turn the jog shuttle to "Block" and press it to confirm the selection. Select the desired program step and confirm.
- To start the new program step press  "Save" and "Start".

## To go back without skipping a program cycle

- Press the  "Back" button to go back to the program stop.

## Program stop

- To stop the program, press  "End".

The program stops.

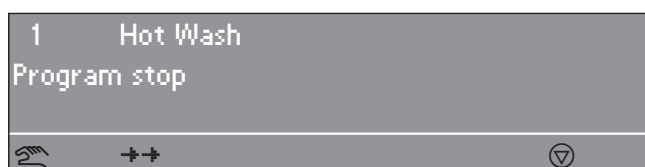

- Press  "End" again to continue the program.

## Program end with water in the drum

If the program is interrupted during a cycle, the display shows either:

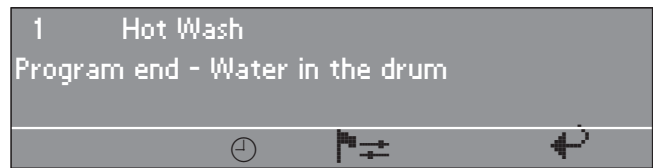

or

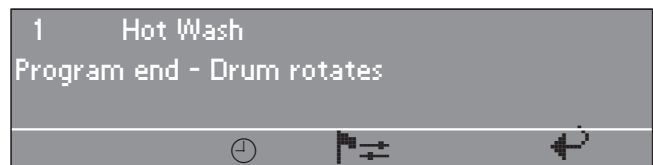

 The drum door is locked.  
**Do not use force!**

- Press the  "Drain" button or select the Drain Extra program and press "Start".
- At the end of the program open the door.

## Canceling a program

- To cancel a program, press the  "End" button twice.

If the program was canceled with water in the machine or during spinning, the display shows:

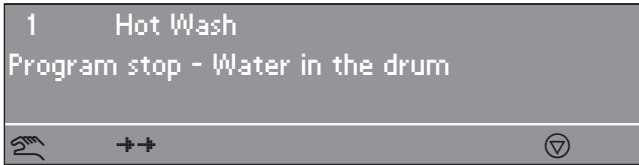

or

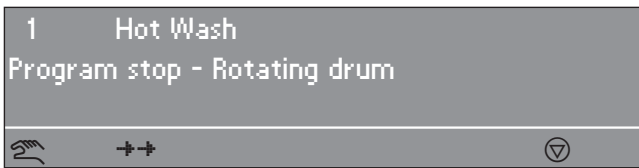



- Press the  "Water drain" button or select the program Extra Spin, and press the "Start" button.

## Canceling a locked program

Locked programs cannot be stopped or canceled.



The display shows that the program is locked if the  "End" button is pressed.

- To unlock the program press the  "Unlock" button.
- Enter the password, by turning the jog shuttle to the desired character in the alpha numeric list and then pressing the shuttle to confirm each selection.

After entering the password the display shows:



- Press the  "Save" button to confirm. The normal display shows and the program can be canceled.

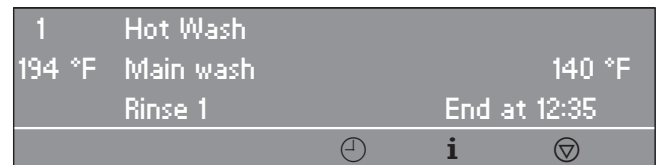

# Use

## Program sequence

The program sequence is shown in the display after the start of the program.

1	Hot Wash				
104 °F	Pre-wash			68 °F	
	Main wash			End at 12:35	
+⏮	🗑️	🕒	⏸	<b>i</b>	⏭

The second display line, here Pre-wash, shows the wash water temperature.

1	Hot Wash				
194 °F	Main wash			140 °F	
	Rinse 1	Cold		End at 12:35	
+⏮	🗑️	🕒	⏸	<b>i</b>	⏭

If the program block Pre-wash has ended, the 2nd line in the display shows the program block Main wash with the current wash water temperature. The 3rd line shows the following program block, here Rinse 1.

The program end display, above 12:35, shows the time of day when the program will be finished.

## i Information

1	Hot Wash				
194 °F	Main wash			140 °F	
	Rinse 1	Cold		End at 12:35	
+⏮	🗑️	🕒	⏸	<b>i</b>	⏭

Press the **i** "Information" button during the program to show information in the display.

1	Hot Wash				
Delay start: 10.7.2003					
Start time: 9:47					
▼					
⏮					

For more information press ▼.

Time after start: 0 h 23 min					
Time left: 0 h 11min					
Time after start: 0 h 23 min					
▼					

Time left: 0 h 11 min					
Repetition: no					
Area 3: Rinse					
▼					

Block 2: Rinse 2					
Block step Wash time 1					
Actual water level: 22 mm					
▼					



Programmed value: 60 mm					
Actual temperature: 95°F					
Programmed temperature: 140 °F					
▼					

1	Hot Wash				
Revolution: 40 rpm					
Rhythm: 12 / 3					
▲					
⏮					

- Press the ⏮ "Back" button to return to the program sequence.

## Language selection

The language can be selected with the  flag symbol. The language is set back to its original setting 5 minutes after the program ends or when the door is opened.

1	Hot Wash	194 °F
2	Cottons	140 °F
3	Cottons Intensive	140°F
		 

Press the function button . The display shows:

Settings	Back 
Main menu	Language
	Supervisor level
 	

- Turn then press the jog shuttle to select "Language".

Settings	Dansk
Language	Deutsch
	English
 	

- Turn the jog shuttle to select the desired language and press to confirm the selection.

## Chip card use

Chip cards are programmed to a machine type. Empty cards can be used with any machine.

- Press I "On" to turn the washer on.

The Welcome screen shows.

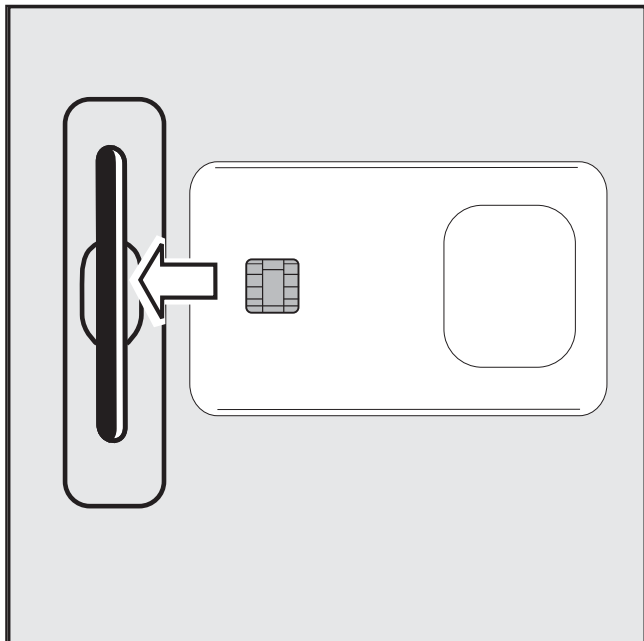

- Insert the card, arrow first, into the card reader.

The display shows the list of programs on the card, example:

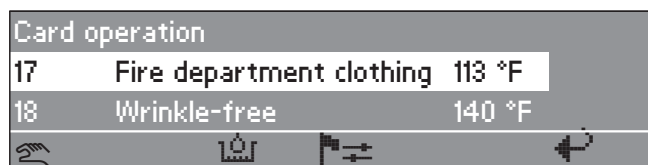

- Turn the jog shuttle to select a program. Press the jog shuttle to confirm the selection.
- Press the "START" button to begin the program.
- Remove the card from the card reader.

Once the program is finished it will be deleted from the machines memory.

⚠ Do not insert any items other than the card into the card reader.

If the card was inserted the wrong way, the display shows:

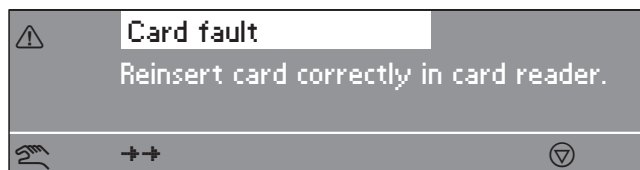

- Reinsert the card properly into the card reader.

If the card is not suitable for this type of machine, the display shows:

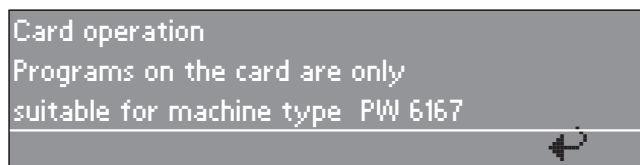

- Insert a card suitable for this machine type.

### Card operation

For laundry loads which need special wash procedures, a single special program is written on a card which is then used to run the program. This function blocks all machine programs. The washer runs only the program saved on the card.

The function "Load" can be activated in the supervisor level. The machine will only accept cards in this function.

## Liquid dispensing system

(Dispensing systems vary)

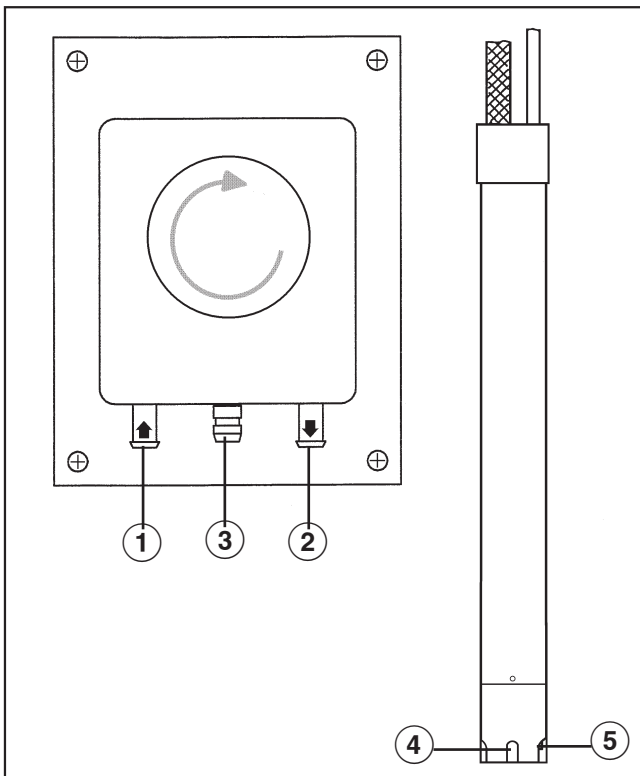

### Priming the dispensing pumps

- ① Hose connection socket (in)
- ② Leakage outlet
- ③ Hose connection socket (out)
- ④ Suction inlet opening
- ⑤ Level indicator

When the dispenser container is empty the pump and the machine will shut off.

The display will indicate that the detergent dispenser is empty.

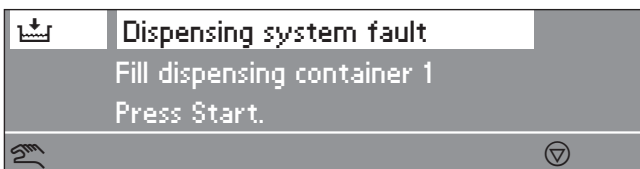

- Refill the dispensing containers.
- Press "Start" to continue the program.

### Deselecting the dispensing

1	Hot Wash	194 °F
2	Cottons	140 °F
3	Cottons Intensive	140 °F

The liquid dispensing can be manually deselected before a program start.

The dispensing pump is turned off. The display shows:

1	Hot Wash	56.0/56.0 lb	
194 °F	Main wash		
	Rinse	1000 rpm	

### Dispensing amount

Always follow the instructions of the chemical manufacturer when using cleaning agents and special application chemicals.

Only use such chemicals for the purpose and in the situation specified by the manufacturer to prevent the danger of adverse chemical reactions and material damage.

If in doubt, check with the manufacturer that the product is suitable for use in this machine.

Liquid detergent should stand at room temperature before being used to ensure proper dispensing.

## Optional modules

### Priming the dispensing pumps

Use the calibration to get liquid detergent to the pumphead. Once calibration is complete run an empty program to get detergent to the machine before actually washing a load of laundry in the machine.

### Dispensing calibration

The dispensing calibration is used to calculate the flow rate of each dispensing pump.

For direct access to the dispensing calibration when the machine is turned off:

- Press and hold the 2<sup>nd</sup> control key from the left.
- Turn the machine on at the mains and release the control key.

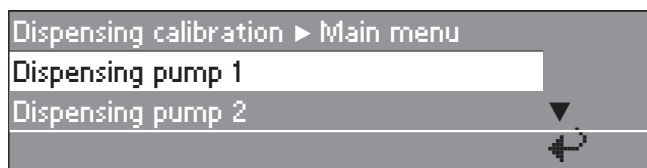

Selections: Dispensing pump 1 to 13

After selecting a dispensing pump the display shows:

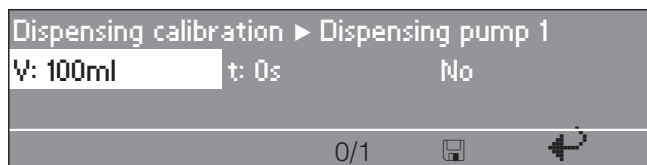

The dispensing amount can be adjusted in 1 ml increments from 0 to 999 ml.

- Press the 0/1 control key, the dispensing hose fills. Press the 0/1 button again to stop.
- Point the hose of the dispensing pump to be determined, in a measuring cup. Hold the cup high enough so the liquid has to be pumped rather than flowing out.

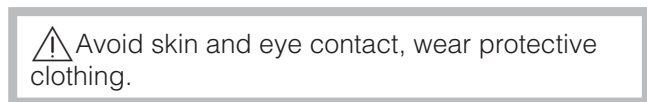

- Press to get back to the main menu.

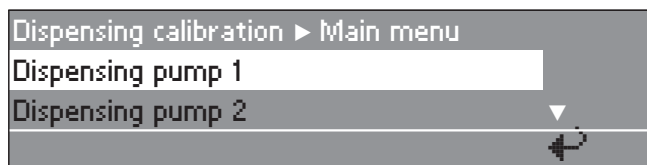

- Select the dispensing pump.

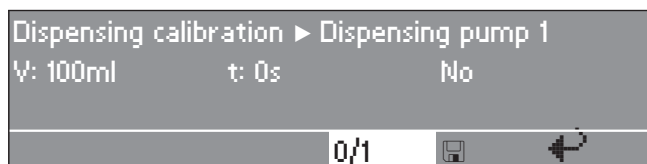

- The dispensing can be manually stopped by pressing the 0/1 button or it will stop automatically after 60 seconds.
- Measure the pumped amount in the measuring cup.

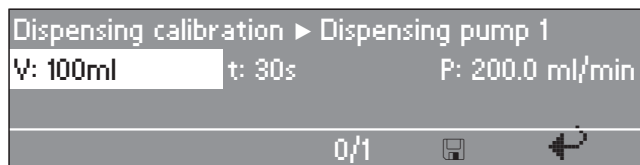

- Enter the measured amount in the "V:" field. The flow rate P: in milliliter per minute is calculated by the control.
- Press "Save" to allocate the measured values to the dispensing pump.
- Reconnect the hose.

### Maintenance of the dispensing system

Rinse the dispensing system with hot water every 2 weeks, or before shutting down the dispenser pumps for any length of time, to prevent the system from clogging.

- Rinse out the suction pipes with water.
- Place the suction pipes in a container with warm water, 104 - 122°F (40 - 50°C).
- Select each pump by using the dispensing calibration.
- Turn on each pump until the dispensing system is rinsed.
- Check the connection points, hoses and washers for leaks.

## Peak load cutoff

When activating the peak load cutoff the heat is turned off and the program is stopped. The display shows:

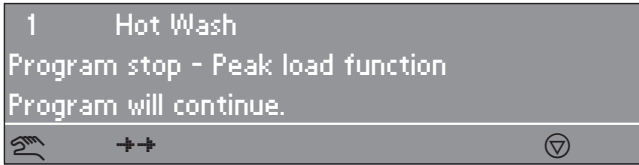

When the peak load function ends the program will continue automatically.

## Communication module

The communication module makes it possible to connect the machine to a PC (Personal Computer).

The outlet for the module is on the back of the machine.

This requires a special Editor Program which is available from the Miele Professional Department.

## Load module

If the machine is equipped with a load module, the load weight will be displayed, in 0.5 lb increments, while loading the laundry. The maximum laundry weight is displayed next to the selected program.

- Reset with the **-> | <-** "zero - setting" if the weight display does not show "00.0" when the drum is empty.

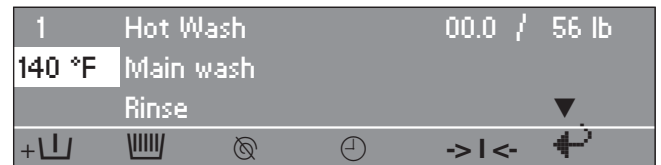

If there was still laundry in the drum when the weight display was reset, the display shows:

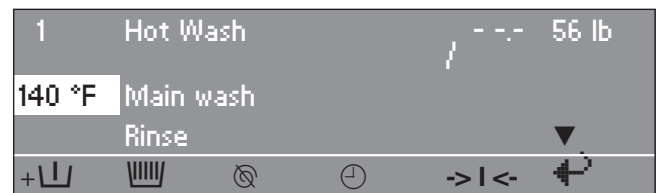

- Reset again with the **-> | <-** button.

If the machine is overloaded (wet laundry) the machine calculates after the programs start with the nominal value. This value is saved in the operating data module.

At the end of a program, with the drum stationary, the residual moisture of the laundry is displayed.

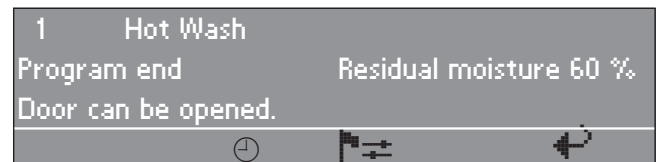

See "Use - Adjust the program" for more information.

## Cleaning and Care

---

### After each use

Never use high pressure cleaners to hose down the machine.

The machine should be cleaned immediately after use.

- After use do not shut the drum door, allow the interior to air dry.

### Cleaning the exterior

⚠ Never use abrasive cleaners, scouring pads, steel wool or caustic cleaners on the machine. They **will** damage the surface.

All surfaces can be cleaned with a solution of warm water and liquid dish soap applied with a soft sponge.

### Door gasket

- Clean any residues on the door gasket with a damp cloth.

### Stainless steel

Stainless steel surfaces can be cleaned using a non-abrasive stainless steel cleaner.

To help prevent resoiling, a conditioner for stainless steel can also be used.

- Apply sparingly with even pressure.

### Detergent containers and siphon tube

- Regularly clean detergent residues from the detergent dispensers, drawers and siphons with warm water.

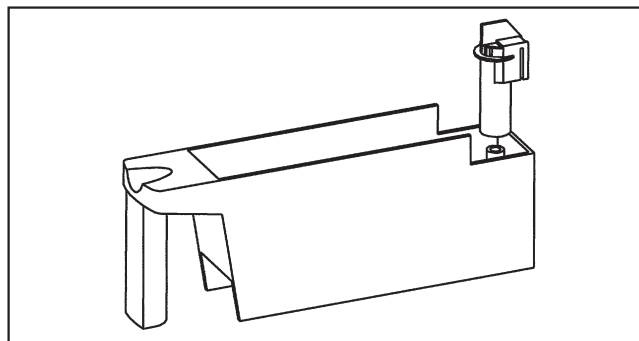

- Pull the siphon tube out, clean it with warm water and reinsert it.

### Vent grille

- Check and clean regularly the wash water vent grille at the rear of the machine.

### Rust

The drum and the wash water drum are made of stainless steel. Water with a high iron content or items like paper clips or iron buttons which are in the laundry, can lead to rust in the drums.

- To help prevent rust, a conditioner for stainless steel can be used.
- Check the door gasket for iron residue and clean with stainless steel conditioner.
- Clean regularly.

Leave the drum door open after use for the interior to air dry.

### Water inlet filters

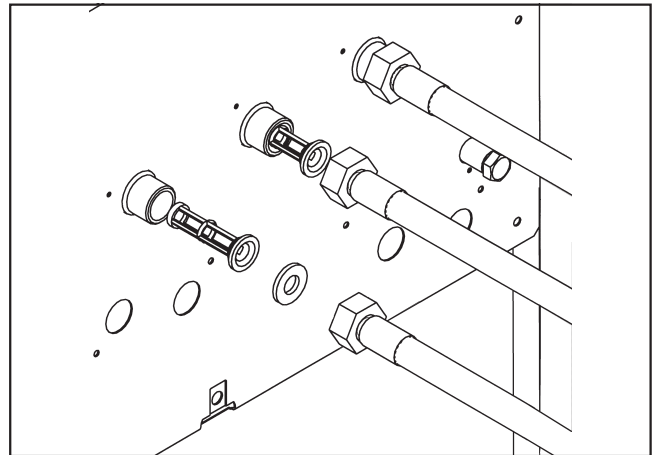

- Check and clean regularly the filters in the water intake faucets, and the water intake hoses.

### Maintenance during downtime

- When the machine is not used for an extended time (4 weeks or more), the drum needs to be rotated manually a couple of times to prevent bearing damage. Repeat every month.

## Cleaning and Care

### Drum bearing lubrication

If the machine needs to be serviced the following message shows:

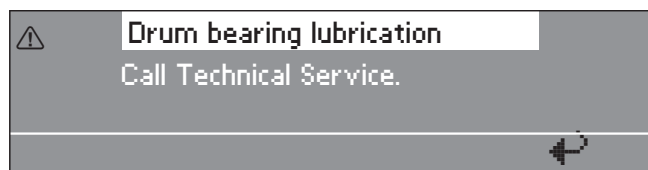

- Press  "back" to delete the message.

The message will show each time the machine is turned on, until the Service Technician has serviced the machine.

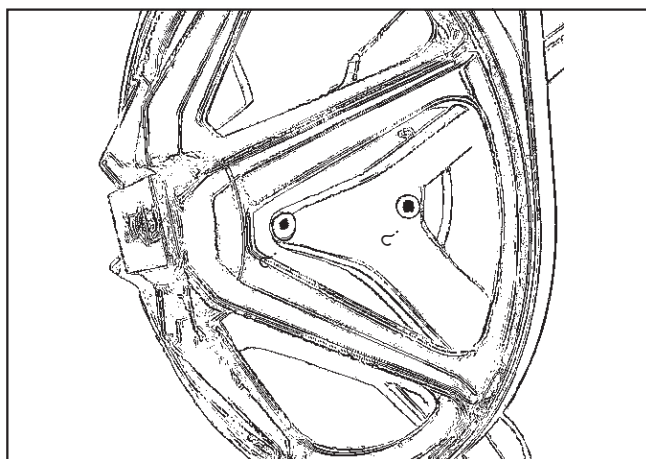

- After about 1000 operating hours, lubricate the drum journal bearing by the lubricating nipple with Arcanol L 100 grease.

### Maintenance during downtime

When the machine is not in use for an extended time (4 weeks or more), the drum bearings must be lubricated (before the downtime).

- Lubricate the drum bearing according to the warning message and turn the drum by hand a few times.
- Repeat every month to prevent bearing damage.

### Reasons for oversudsing

#### Detergent type

- Only use detergent formulated for use in commercial washers. Detergents for domestic machines are not suitable.

#### Too much detergent

- Follow the detergent manufacturer's instructions and adjust the amount to the local water hardness.

#### Oversudsing detergent

- Use a low sudsing detergent or contact Miele's detergent application specialists.

#### Very soft water

- In areas with soft water, use less detergent.

#### Soiling level of laundry

- For lightly soiled laundry use less detergent.

#### Residue, e.g. undissolved detergent on laundry

- Run a prewash without detergent and without selecting a temperature.
- Laundry which has been pre-treated in detergent before washing must be thoroughly rinsed before running a wash program.

#### Small loads

- Reduce the amount of detergent accordingly.

#### Drum speed too high during a wash (Profitronic-controls)

- Reduce the drum speed and wash rhythm.

### The drum door cannot be opened

- Press against the door handle, turn the machine on then off and pull on the door handle once more.

### The safety mechanism of the door handle is disengaged

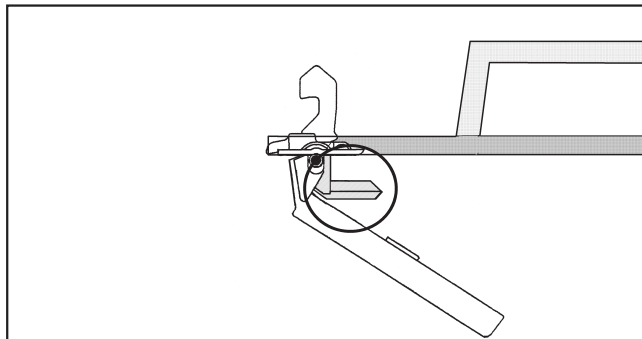

The door handle has lost its function. The door cannot be opened or closed.

The safety mechanism is designed to protect the handle from damage, i.e. if too much force is being used in an attempt to open the door.

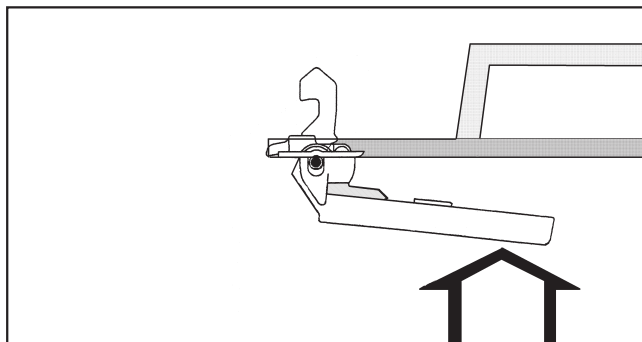

- Firmly press against the door handle until you hear the safety mechanism click.

The door can now be opened or closed provided there is no water in the machine.

## Frequently asked questions

### Power failure - Emergency door release

#### During a short power failure

The program remains in the last position. When power is restored the following message appears in the display:



- Press "Start" to continue the program.

#### Extended power failure

- Turn the machine off.
- Turn the electrical supply off at the mains.
- Close the steam valve (on-site).

The machine must be drained and the drum door opened manually to unload the machine.

#### Draining the wash water

- Place a container under the manual drain at the rear of the machine.
- Open the drain by loosening the venting screw. **Do not** take it completely out.
- A small amount of water will drain from the machine.
- Tighten the venting screw again and test for leaks by opening the water supply.

### Open the door manually



- Insert and hold a small screwdriver in the opening next to the door lock.
- Press against the door handle, then pull it towards you to open the door.  
**Do not use force!**
- Remove the laundry.

### Display Maintenance notice

- Call Technical Service for maintenance if the display shows the following message after turning the machine on.

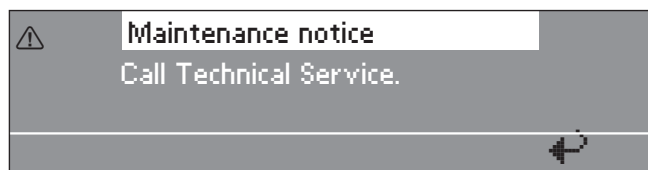

The display goes out after 5 seconds.

### Fault messages

⚠ Repairs to electrical or steam appliances should only be carried out by a Miele authorized technician in accordance with local and national safety regulations. Unauthorized repairs could cause injury or machine damage.

Faults that occur before or after the start of a program flash in the display.

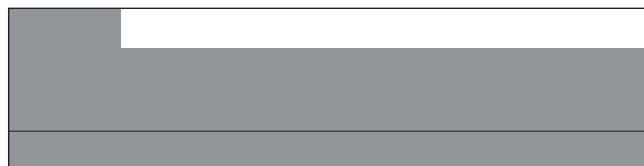

If the display remains off, the washer has no power.

- Check the plug, main switch and fuses on-site.

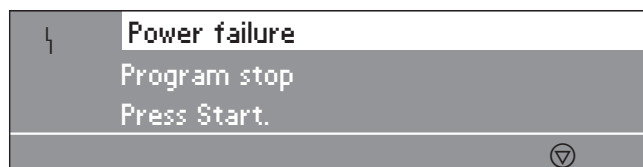

- Press "Start".

This fault message can also indicate that the overload cut-out of the drive motors has over heated.

- Allow the motor to cool.

## Frequently asked questions

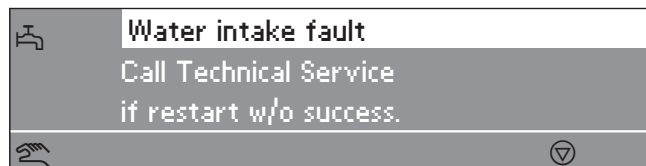

- Check the water supply and press "Start".



- Press the door handle so that it closes with a click, press "Start".

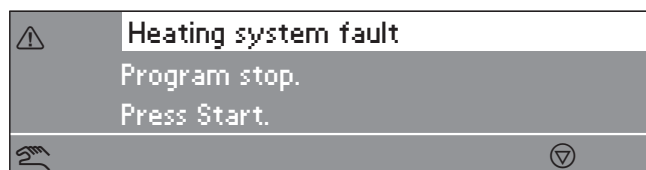

- Press "Start" to continue the program without heating.

If the program has a "Thermostop" the program will time out.

- Call Miele Technical Service.
- Some programs may be canceled if this messages shows.  
Call Technical Service.



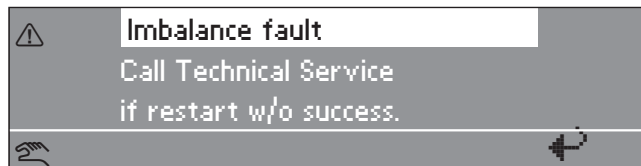

- Allow the motor to cool.

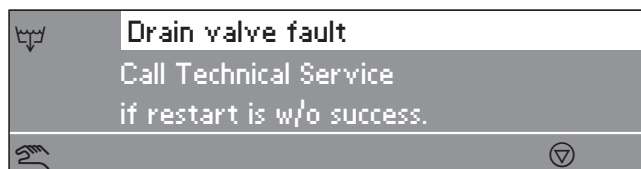

Large imbalance, the imbalance switch has activated.

- Turn the machine off and on again
- Press "Start".



- Check and clean the drain system and press  "Start".

A defective drain valve should only be replaced by an authorized service technician.

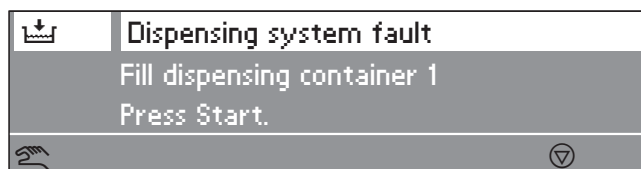

- Change/fill the dispensing container.

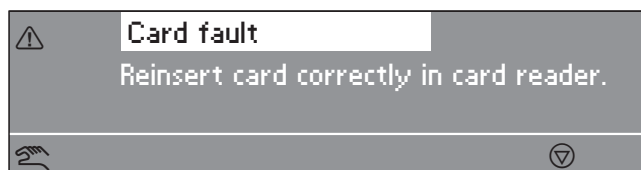

- Insert the card properly into the card reader.

- In the event of a fault which you cannot correct yourself, please contact Technical Service.
- When contacting Technical Service please quote the model, serial number (SN) and part number (M.-Nr.) of the machine.























<b>Model</b>			
<b>SN:</b>	/ 0 0 0 0 0 0 0 0		
<b>Art.-Nr.</b>		<b>Mat.-Nr.</b>	
<b>IBN</b>			

They can be found on the data plate located at the top of the door opening (when drum door is open) or on the back of the machine at the top.

- When contacting Technical Service report the fault in the display.

Only use original Miele spare parts when performing maintenance or repairs on this machine. When ordering please quote the model, serial number (SN) and part number (M.-Nr.) of the machine.

# Guide to the data plate symbols

<b>Model</b>		(1)				
<b>SN:</b>		(2)				
<b>Art.-Nr.</b>		(3)				
<b>Mat.-Nr.</b>		(4)	(18) 	(19) 	<b>Total</b>	<b>Total</b>
	(5)					
						
						
						
	(6)					
	(7)					
						
	(9)		$Q_n$ (Hi)			
	(10)					
	(11)					
	(12)					
	(13) /min					
	/min					
				IP X4	(23)	

<b>Model</b>	
<b>SN:</b>	/ o o o o o o o o o o
<b>Art.-Nr.</b>	<b>Mat.-Nr.</b>
<b>IBN</b>	

- 1 Model
- 2 Serial number
- 3 Item number
- 4 Material number
- 5 Voltage / Frequency
- 6 Control breaker
- 7 Motor
- 8 Drum data
- 9 Drum diameter / Drum depth
- 10 Spin speed
- 11 Drum volume / Dry laundry weight
- 12 Kinetic energy
- 13 Acceleration time
- 14 Deceleration time
- 15 Heating
- 16 Name / Year of manufacture
- 17 Commissioning date
- 18 Electrical heating
- 19 Breaker at the building's electrical service panel
- 20 Steam heat indirect
- 21 Steam heat direct
- 22 Gas heating
- 23 Certificates

## Noise level

	Wash cycle	Spin cycle
PW 6241	60 dB	82 dB
PW 6321	60 dB	80 dB

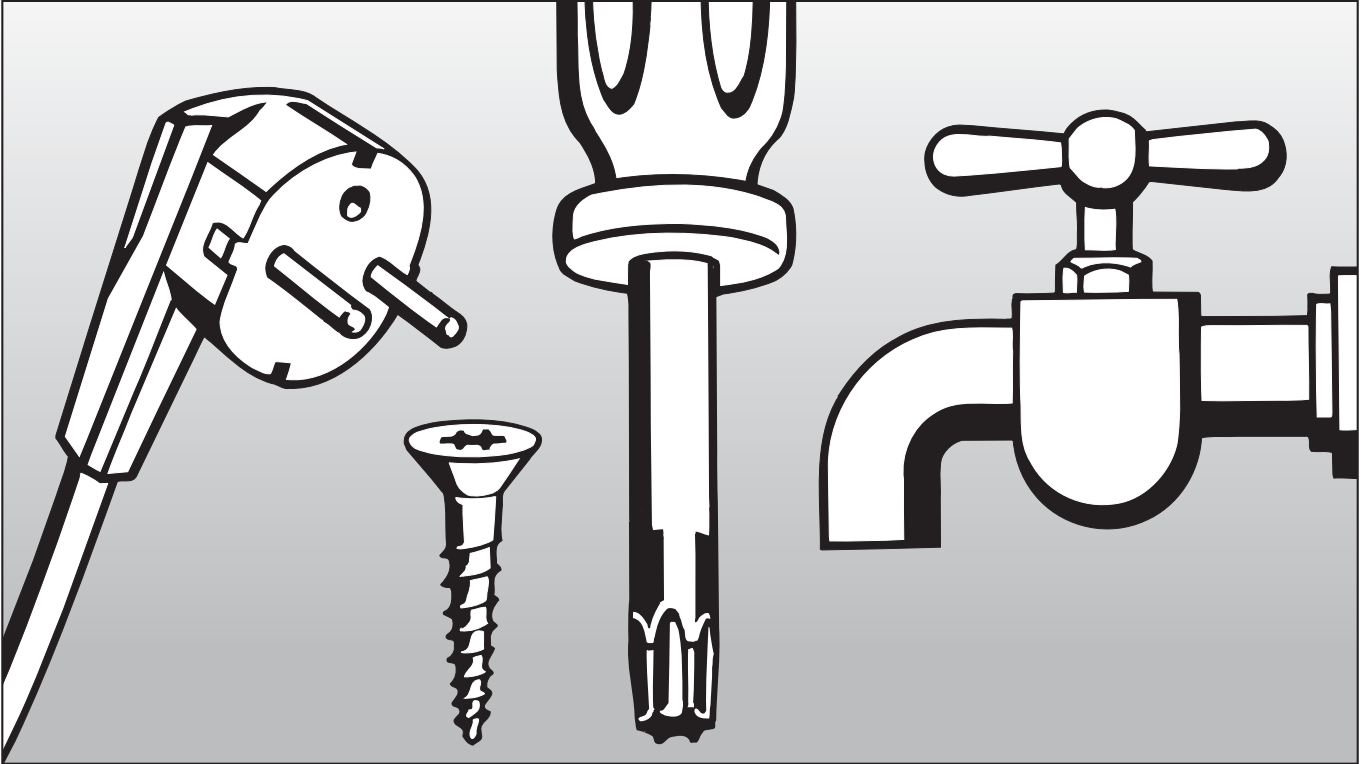

## Installation Instructions

## Help to protect the environment

---

### **Disposal of the packing materials**

The packing materials protect the appliance during shipping. They have been designed to be biodegradable and recyclable.

To prevent suffocation, ensure that any plastic wrappings, bags, etc. are disposed of safely and kept out of the reach of children.

### **Disposal of an old appliance**

Old appliances may contain materials that can be recycled. Please contact your local recycling center about the possibility of recycling these materials.

Ensure that the appliance presents no danger to children while being stored for disposal. Before discarding an old appliance, unplug it from the outlet, cut off its power cord and remove any doors to prevent hazards.

The washer must only be installed by a Miele authorized service technician.

Before installation or service disconnect the power supply to the work area.

The minimum dimensions and distance required from the wall, as shown in the installation diagram, must be observed to allow service to be performed and the data plate to be viewed.

## Installation site

A concrete or reinforced floor is the most suitable surface for the washer. These types of floors are less prone to vibration during the spin cycle.

The washer must be leveled for proper operation. The machine does not need to be installed on a base, however, any unevenness in the floor must be compensated for.

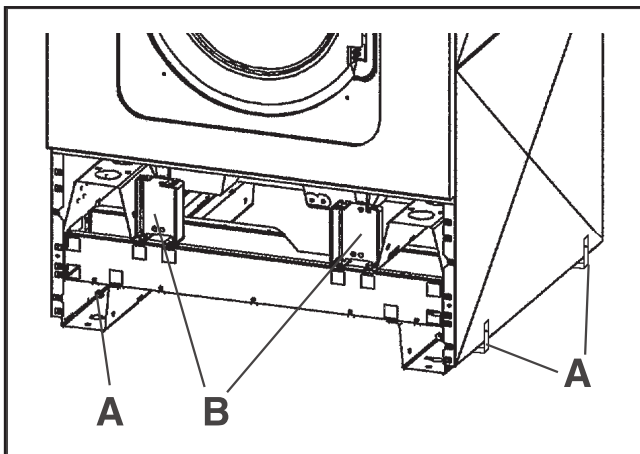

Do not install or store this machine in a room where temperatures below freezing may occur or where the machine may be exposed to the weather.

Do not install the washer on carpeting. Carpeting will block the washers air vents.

## Removing the shipping struts

- The fixing angles "A" on the diagram, 2 on each side panel are fixed with 3 M 10 (SW 17) hex screws. Remove these.

The shipping struts "B" on the diagram, 2 at the front and 2 at the rear are each fixed with 3 M 10 (SW 17) hex screws.

- To remove them detach the front service panel and the rear panel. Unscrew the 3 M6 hex screws (SW 8) at the bottom edge of the front service panel, and take it off. Unscrew 8 hex screws in the rear panel and remove.

The cover for the bottom front and the rear panels are secured to the side panels, and should be fitted when the machine has been installed. Use the supplied screws.

The shipping struts should be stored in a safe place for future use. They must be refitted if the machine is moved.

# Installation Instructions

---

## Plumbing

The machine should be connected to two water supply faucets, which conform with local and national regulations. Installation must be carried out by an authorized service technician.

To ensure the machine is correctly connected please follow the installation plan and the installation instructions supplied with the machine.

## Connecting the water intake / water drain hoses

See the enclosed installation plan.

A water pressure flow rate of at least 14.5 psi, maximum 145 psi is required.

The inlet pressure hoses supplied with the machine must be used for connection to the water supply.

The hoses should only be replaced with genuine Miele spare parts which fulfill the pressure requirements.

The hot water intake must not exceed a temperature of 158°F (70°C).

### Cold water connection only

See the enclosed installation diagram.

## Electrical connection

 All electrical work must be performed by a qualified service technician in accordance with applicable codes and standards.

When installing a residual current device (RCD) a Type B GFCI circuit breaker must be installed.

The connecting terminal is located behind a cover.

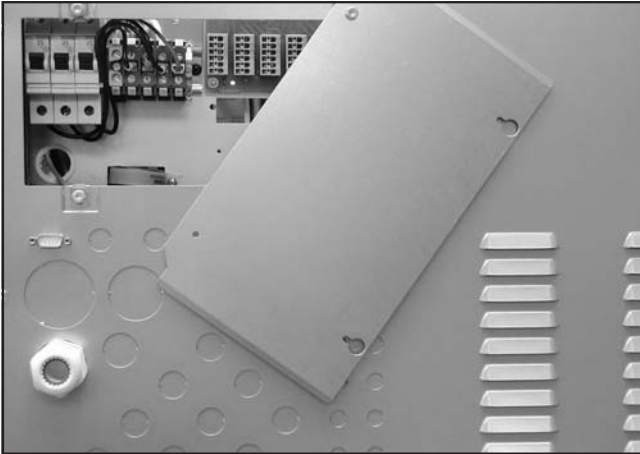

The machine must only be connected to the voltage and frequency shown on the data plate.

The machine is equipped with a multi-tap transformer.

**Steam heated washers** are factory set to 3 phase, 208 V, 60 Hz

They can be converted to 3 phase, 240 V, 60 Hz by a Miele Service Technician.

**Electrically heated washers** are factory set to 3 phase, 230 V, 50/60 Hz

They can be converted to 3 phase, 208 V, 60 Hz by a Miele Service Technician.

## Equalizer

Secure the potential equalizer, if necessary.

To activate the heating the water level in the drum must be  $4 \frac{5}{16}$ " (110 mm) high.

A motor overload protection is located in the motor winding.

See the enclosed wiring and installation diagrams.

## Steam connection

The steam connection must only be connected by a certified installer. For more information see the enclosed installation plan and the installation manual.

## Connecting the dispensing pumps

The connecting terminal for 4 time controlled dispensing pumps is located behind the cover next to the electrical connection. See the supplied wiring diagram.

The dispensing pumps can be operated without the multifunction module.

## Quick Guide

---

### 1. Sort the laundry

Only use this machine for items that are machine washable, see the fabric care label.

- Empty all pockets.

### 2. Turn the machine on and load the laundry

- Press the **I** "On" button to turn the machine on.
- Open the drum door and load the laundry.
- Close the drum door.

### 3. Add detergent

- Add detergent to compartment:
  - 1** = for the Prewash (if required)
  - 2** = for the main wash
  - 3** = fabric softener
  - 4** = liquid bleach
  - 5** = liquid detergent

### 4. Select a program by turning the jog shuttle

Programs may vary depending on the offerings of your machine.

### 5. Press "Start".

The selected program begins.

- If "Door lock fault" appears in the display press the door handle so that it closes with a click. Press "Start".



### 6. At the end of a program

The program end is displayed.

- Open the door by pulling the handle. Remove the laundry.
- Leave the drum door open.
- Turn the machine off with the **0** "Off" button.

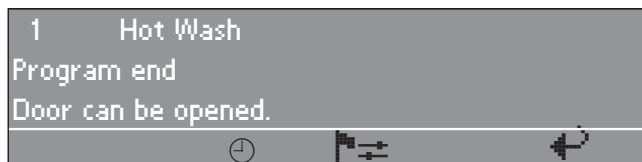







**Please have the model and serial number  
of your appliance available before  
contacting Technical Service.**

---

**U.S.A.  
Miele, Inc.**

**National Headquarters**

9 Independence Way  
Princeton, NJ 08540  
Phone: 800-843-7231  
609-419-9898  
Fax: 609-419-4298  
www.mieleusa.com

**Technical Service & Support  
Nationwide**

Phone: 800-999-1360  
Fax: 888-586-8056  
TechnicalService@mieleusa.com

**Canada  
Miele Limited**

**Headquarters and Showroom**

161 Four Valley Drive  
Vaughan, ON L4K 4V8  
Phone: 800-643-5381  
905-660-9936  
Fax: 905-532-2290  
www.miele.ca  
professional@miele.ca  
(commercial enquiries)

**MieleCare National Service**

Phone: 800-565-6435  
905-532-2272  
Fax: 905-532-2292  
customercare@miele.ca  
(general and technical enquiries)

